



PACKAGE WITH PURPOSE

GUNTHERMELE 1857

**GIFT PACKAGING GUIDE
2018 - VOLUME 161**

Discover Our Website

gunthermele.com



PROCESS AN ORDER • REVIEW ORDER HISTORY • MANAGE YOUR ACCOUNT • TRACK SHIPMENTS

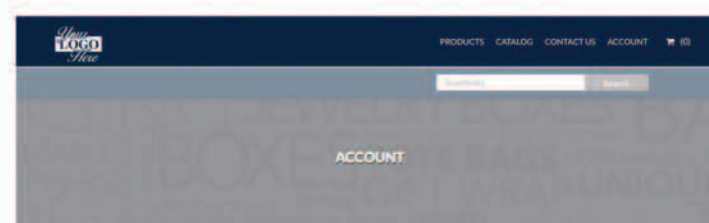
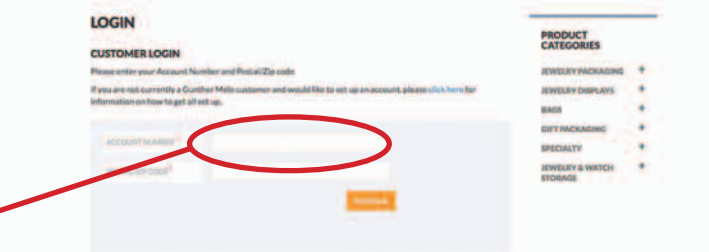
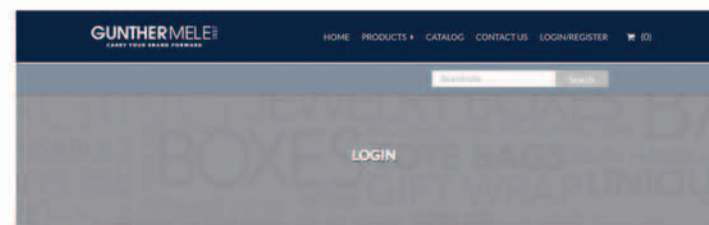
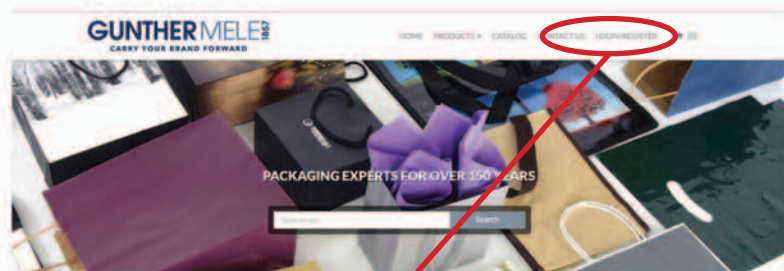

STEP 1

Click on the Login/Register button at the top of the menu bar on our website, to get started.

STEP 2

Next to Account Number, enter the six or eight-digit customer # that is associated with your account.

Enter your Zip/Postal Code associated with the billing address of your account. Press the Continue button.

STEP 3

When you have successfully logged on, you will see the message "Successful Login" on the Account Screen. At this point you can review current orders or place a new order.

Order History (A)

Current Open Orders - current orders in process that have not shipped.

Shipped Orders - orders that have shipped since June 1st, 2015 (tracking numbers provided for tracing recent orders).

Cancelled Orders - cancelled orders since June 1st, 2015.

Orders Shipped prior to May 31, 2015 - additional order history.

My Products ()

Custom product recap of those items that have been created and produced specifically for your account.

Manage Account (C)

Ability to review and update all relevant information that is currently on file for your account ("Bill to" information).

If you need assistance accessing your account or using the functionality of our website, please contact us at 1.888.486.8437 or email us at info@gunthermele.com

TABLE OF CONTENTS

WHAT'S



Look for our NEW items, colours or sizes throughout the catalogue!

CYOL 100% Recyclable ALL PAPER Shoppers	11
In Stock 100% Recyclable ALL PAPER Shoppers.....	12
In Stock Window Jewellery Displays	33
Special Order Nest Boxes - 4 New Colours!	35
Blitz Ultra Sonic Jewellery Cleaning Machine	40
Custom E-Commerce Boxes	47
Inspirations Gift Wrap	50
Sullivan Jewellers Roll Gift Wrap	51

BAGS

Rope Handle Paper Totes.....	4	San Francisco Shoppers	15
Eclipse and Geo Eurototes	5	Custom Paper Shoppers.....	16 -17
Winter Forest, Christmas Village Bags	6	Poly Merchandise and Celestial Pattern Bags..	18
London Shoppers	7	Frosted Poly Bags	19
Manhattan Tote Bags	8	Custom Printed Poly Merchandise Bags ..	20 - 21
Mod Tote Bags	9	Custom Printed Poly Shopping Bags.....	22 - 23
New Custom Rope Handle Paper Eurototes	10 - 11	Reusable Shopping Bags	24
New Kraft and White Paper Bags	12 - 13	Toronto Totes and Metallic Reusable	25
Full Colour Digital Printing Option	13	Custom Full Colour Laminated Reusable ..	26 - 27
Graphic Design Paper Shoppers.....	14	Custom Reusable Fabric Shoppers.....	28 - 29
Colour Paper Shoppers	14 - 15	Garment Bags and Covers	42

JEWELLERY PACKAGING

2-Piece Jewellery Packaging	30 - 32	Gift Card/Certificate Boxes and Folders	36 - 37
Specialty and Gift with Purchase	33	Pouches	38 - 39
New Nest Boxes	34 - 35	New Jewellery Cleaning Cloths and Cleaners ..	40 - 41

FOLDING BOXES

Apparel Boxes	43	Tuckit® and Pop-Up Boxes	45
Folding Gift Boxes	44	E-Commerce Corrugated Boxes	46 - 47

TISSUE AND GIFT WRAP

Tissue Paper	48 - 49	New Jewellers Rolls	51
New Inspirations Gift Wrap	50	Special Order Giftwrap	52 - 55

RIBBONS AND SEALS

Printed and Unprinted Ribbon	56 - 61	New Customized Seals - Full Colour	64 - 65
Bows, Cellophane and Dispensers	57	Print Information and Colours.....	66 - 67
Customized Seals - Foil Print	62 - 63		

Stuck for ideas?
Visit us on social media!



Follow us on
Twitter



Like us on
Facebook



Be inspired by us on
Pinterest



Rope Handle Paper Totes

- Matte lamination
- Matching rope handle
- Minimum order is 100 in any size

CODE	TYPE	SIZE (inches)	PRICE/EACH		
			100 +	500 +	1000 +
A 239606 __	Novelty	6 x 3.5 x 6 x 3.5	\$0.90	\$0.81	\$0.70
B 239709 __	Small gift	9 x 3.5 x 7 x 3.5	\$1.03	\$0.88	\$0.79
C 239810 __	Gift	8 x 4 x 10 x 4	\$1.13	\$0.97	\$0.88
D 230908 __ T	Trapezoid	9/7 x 4 x 8.5 x 4	\$1.33	\$1.08	\$1.04
E 238116 __	Fashion	16 x 6 x 12 x 6	\$2.09	\$1.84	\$1.60
F 23940408	Wine (silver only)	4.75 x 4 x 14 x 4	\$1.22	\$1.09	\$0.96
G 231011 __	Watch	10 x 5 x 11 x 5	\$1.46	\$1.20	\$1.07
H 23881098	Diamond Tote	8 x 4 x 10 x 4	\$1.11	\$0.99	-

PREMIUM HIGH STYLE EUROTOTES AVAILABLE IN 8 COLOURS

15 Black	00 White	07 Gold	08 Silver	42 Brown	11 Blue	66 Burgundy	10 Green
Novelty							
Small Gift							
Gift							
Trapezoid							
Fashion							
Watch							
Wine							

- Novelty
- Small Gift
- Gift
- Trapezoid
- Fashion
- Watch
- Wine

Durable & Fashionable!

FOIL PRINT
 <1000 - 20¢ each
 >1000 - 18¢ each

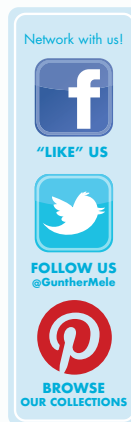

FOIL PRINT
 <1000 - 20¢ each
 >1000 - 18¢ each

Eclipse and Geo Eurototes

Eurototes that match our Eclipse and Geo hinged packaging.

- Matching rope handles
- Minimum 100 per colour
- Can be Foil Printed on one side only

CODE	SIZE (inches)	PRICE/EACH	
		100+	500+
A 230606 ___	6 x 3.5 x 6 x 3.5	\$0.99	\$0.91
B 231008 ___	10.5 x 5 x 8.5 x 5	\$1.26	\$1.13

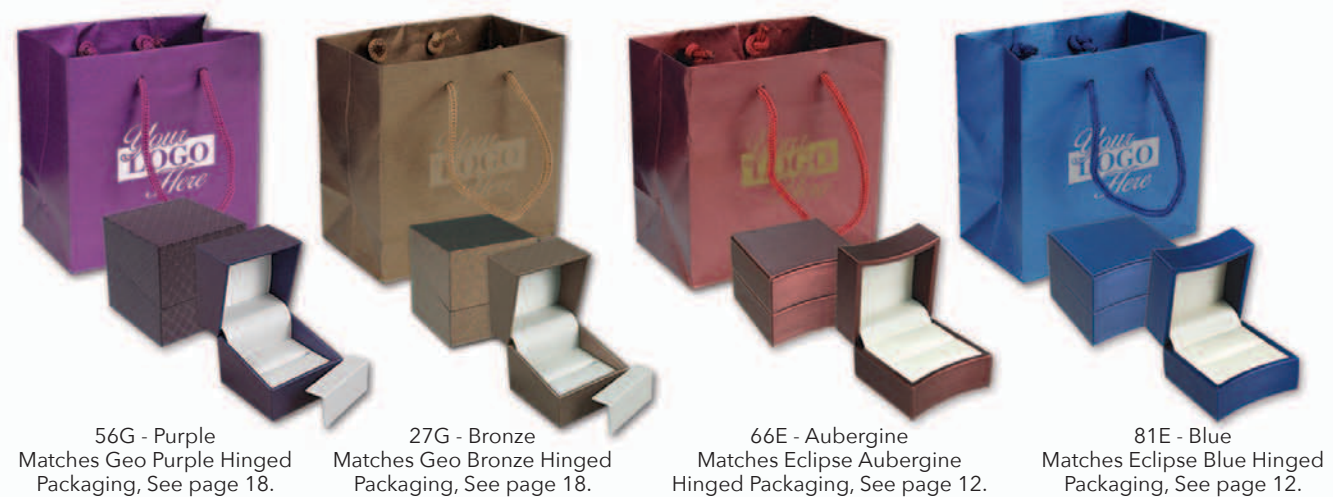

Winter Forest

Laminated Paper Shoppers with Rope Handle

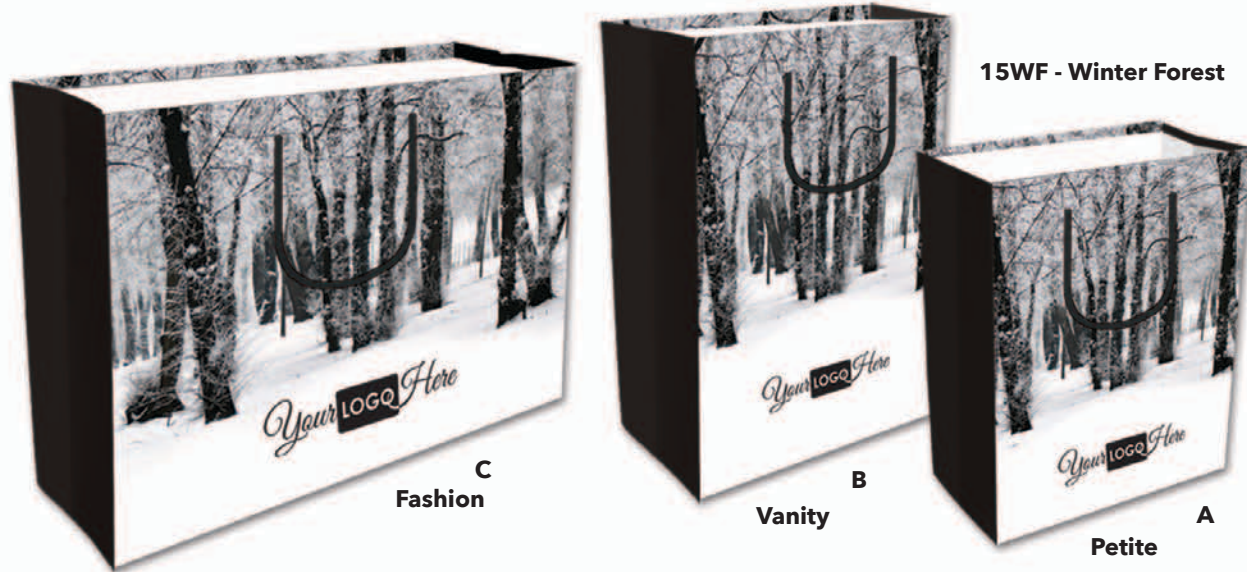

Christmas Village

Laminated Paper Shoppers with Rope Handle



FOIL PRINT
<1000 - 20€ each
>1000 - 18€ each



London Shoppers

Paper Shoppers with Grosgrain Handle

- Matte and Gloss laminated colors, plus uncoated kraft
- Five sizes and nine colours
- Minimum order is 100 per size per colour

CODE	SIZE (inches)	CASE	PRICE/EACH	
			100 +	1000 +
A 235863	6 x 3 x 6 x 3	100	\$0.93	\$0.83
B 235879	8 x 4 x 10 x 4	100	\$1.22	\$1.10
C 235886	12.5 x 4.5 x 9 x 4.5	100	\$1.66	\$1.49
D 235887	16 x 6 x 12 x 6	100	\$2.07	\$1.82
E 235888	20 x 6 x 14 x 6	50	\$2.95	\$2.67



FOIL PRINT
<1000 - 20€ each
>1000 - 18€ each

CODE	TYPE	SIZE (inches)	CASE	PRICE/EACH		
				100+	500+	1000+
A 230809	Petite	8 x 4 x 10 x 4	100	\$0.86	\$0.71	\$0.65
B 231013	Vanity	10 x 5 x 13 x 5	100	\$0.92	\$0.78	\$0.70
C 231612	Fashion	16 x 6 x 12 x 6	100	\$1.25	\$1.04	\$0.98



FOIL PRINT
<1000 - 20€ each
>1000 - 18€ each

	15M Black Matte	15G Black Gloss	00M White Matte	00G White Gloss	02G Champagne Gloss	08G Pewter Gloss	75M Kraft Matte	03M Mustard Matte	01G Pink Gloss
6 x 3 x 6 x 3	U	U	U	U	U	U	U	U	U
8 x 4 x 10 x 4	U	U	U	U	U	U	U	U	U
12.5 x 4.5 x 9 x 4.5	U	U	U	U	U	U	U	U	U
16 x 6 x 12 x 6	U	U	U	U	U	U	U	U	U
20 x 6 x 14 x 6	U	U	U	U	—	—	U	—	—

All print orders subject to \$30 set-up charge. Applicable artwork, and plate charges may apply. See page 126

All print orders subject to \$30 set-up charge. Applicable artwork, and plate charges may apply. See page 126.

Please allow 2 - 5 weeks for printed items from approved art.

SPECIAL ORDER

SPECIAL ORDER

Please allow 3 - 5 weeks for printed items from approved art.



Manhattan Tote Bags

Uncoated Paper, Twill Ribbon Handle

- Made with recycled material
- Minimum order is 100 per size per colour
- Foil Printing is available

CODE	TYPE	SIZE (inches)	CASE	PRICE /EACH	
				100 +	1000 +
A 245845 __	Mini	5 x 4 x 6 x 4	100	\$0.90	\$0.86
B 245841 __	Small	8 x 4 x 10 x 4	100	\$1.20	\$1.06
C 245843 __	Medium	10 x 5 x 13 x 5	100	\$1.39	\$1.35
D 245844 __	Large	16 x 6 x 12 x 6	100	\$1.88	\$1.70
E 245860 __	X-Large	20 x 6 x 14 x 6	50	\$2.99	\$2.66
F 245898 __	Bottle Bag	4.5 x 4.5 x 15 x 4.5	100	\$1.24	\$1.02



FOIL PRINT
 <1000 - 20¢ each
 >1000 - 18¢ each

	15 Black	00 White	75 Kraft	08 Grey	81 Ivory	12 Espresso	09 Red	41 Fuchsia	11 Navy	10 Green	60 - Light Green	
Mini	U	U	U	U	U	U	U	U	U	U	U	U
Small	U	U	U	U	U	U	U	U	U	U	U	U
Medium	U	U	U	U	U	U	U	U	U	U	U	U
Large	U	U	U	U	U	U	U	U	U	U	U	U
X-Large	U	U	U	-	-	-	-	-	-	-	-	-
Bottle	U	U	U	-	-	U	U	-	-	-	-	-

Mod Tote Bags

Matte Laminated, Fold-over Tops

- Contains 30% recycled material
 - Die-cut handle
- Minimum order is 100 per size
- Foil Printing is available

CODE	TYPE	SIZE (inches)	CASE	PRICE/EACH	
				100 +	1000 +
A 245800 __	Micro Mini With Rectangular Handle	5.75 x 1.75 x 5.75 x 1.75	100	\$1.32	\$1.14
B 245846 __	Mini With Rectangular Handle	8 x 2.5 x 8 x 2.5	100	\$1.53	\$1.35
C 245847 __	Medium With Round Handle	12 x 4 x 12 x 4	100	\$2.37	\$2.06
D 245848 __	Mega With Triangle Handle	15 x 5.5 x 15 x 5.5	100	\$3.31	\$3.26
E 245855 __	Bottle Bag With Circular Handle	4.5 x 3.375 x 15.5 x 3.375	100	\$1.51	\$1.42
F 245859 __	Two Bottle Bag With Rectangular Handle	8.25 x 3.375 x 15.5 x 3.375	100	\$1.98	\$1.77



FOIL PRINT
 <1000 - 20¢ each
 >1000 - 18¢ each

	15 Black	00 White	08 Silver	41 Fuchsia	10 Green	11 Blue	97 Trellis
Micro	U	U	U	U	U	U	U
Mini	U	U	U	U	U	U	U
Medium	U	U	U	U	U	U	U
Mega	-	-	-	-	-	-	-
Bottle	U	U	U	U	U	U	U
Two Bottle	U	U	U	U	U	U	U

All print orders subject to \$30 set-up charge. Applicable artwork, and plate charges may apply. See page 126.

All print orders subject to \$30 set-up charge. Applicable artwork, and plate charges may apply. See page 126.



The Ultimate Environmental Choice ...

Featuring Woven Paper Rope Handles



Custom Rope Handle Paper Eurototes

Make a creative impression... the combinations are endless!

Prices include up to 2 ink print colours:

SIZE (inches)	TYPE	PRICE/EACH		
		3,000	5,000	10,000
6 x 3.5 x 6 x 3.5	Novelty	\$0.777	\$0.628	\$0.549
9 x 3.5 x 7 x 3.5	Small Gift	\$0.918	\$0.799	\$0.695
8 x 4 x 10 x 4	Gift	\$0.999	\$0.858	\$0.766
9/7 x 4 x 8.5 x 4	Trapezoid	\$1.133	\$0.959	\$0.878
3.375 x 3.5 x 13 x 3.5	Wine	\$0.846	\$0.691	\$0.643
16 x 6 x 12 x 6	Fashion	\$1.635	\$1.543	\$1.376
16 x 6 x 19 x 6	Saville	\$1.998	\$1.877	\$1.803

Prices include 4 colour process print:

6 x 3.5 x 6 x 3.5	Novelty	\$0.818	\$0.642	\$0.559
9 x 3.5 x 7 x 3.5	Small Gift	\$0.978	\$0.821	\$0.715
8 x 4 x 10 x 4	Gift	\$1.081	\$0.878	\$0.787
9/7 x 4 x 8.5 x 4	Trapezoid	\$1.146	\$0.973	\$0.886
3.375 x 3.5 x 13 x 3.5	Wine	\$0.882	\$0.723	\$0.677
16 x 6 x 12 x 6	Fashion	\$1.719	\$1.577	\$1.454
16 x 6 x 19 x 6	Saville	\$2.253	\$1.922	\$1.852

• Combination foil print and ink printing available

Great for resale or promotions!

- No charge for printing plates (\$275 proof charge applies)
- Substitute a satin ribbon handle for the standard rope - add \$0.10/ea.
- Add metal grommets to your bag for only \$0.06/ea.



FOIL PRINT
Add \$0.06/ea. per side
< 25% coverage

100% Recyclable All Paper Shoppers

Consider adding our industry-first ALL PAPER ROPE HANDLES to your custom eurotote! Up to 40% post-consumer content. Water based inks and varnishes.

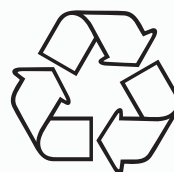

SIZE (inches)	TYPE	3,000	5,000	10,000
6 x 3.5 x 6 x 3.5	Novelty	\$0.700	\$0.630	\$0.570
9 x 3.5 x 7 x 3.5	Small Gift	\$0.780	\$0.710	\$0.640
8 x 4 x 10 x 4	Gift	\$0.830	\$0.750	\$0.670
10 x 5 x 13 x 5	Vanity	\$0.870	\$0.780	\$0.700
16 x 6 x 12 x 6	Fashion	\$1.310	\$1.180	\$1.060

Design your own bag online with our interactive **MyDesign™** tool!
www.gunthermele.com



We can customize to any size bag you require - just ask!

Please allow 2 - 3 weeks for printed items from approved art.

IN STOCK

IN STOCK

Please allow 2 - 3 weeks for printed items from approved art.

The Ultimate in recyclability.

New

The 100% Recyclable ALL PAPER Shopper

Industry first, with durable PAPER ROPE HANDLES. 40% post-consumer content.



CODE	SIZE (inches)	CASE	PRICE/EACH	
			100+	1000+
A 230606	6 x 3.5 x 6 x 3.5	100	\$0.78	\$0.69
B 231013	10 x 5 x 13 x 5	100	\$0.97	\$0.85
C 231612	16 x 6 x 12 x 6	100	\$1.46	\$1.29



75AK - Kraft 00AW - White 15AB - Black

New

DEBOSSING
 <1000 - 20¢ each
 >1000 - 18¢ each

FOIL PRINT
 <1000 - 20¢ each
 >1000 - 18¢ each

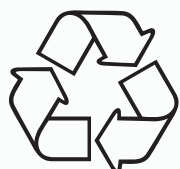

Paper Twist Handle Shopping Bags

Sturdy, durable paper shoppers. Our best value bags.

* Minimum order quantity is one case pack

CODE	TYPE	SIZE (inches)	CASE	12 - Kraft PRICE/EACH			00 - White PRICE/EACH		
				200 +	250+	1000 +	200 +	250+	1000 +
230508	Prime	5 x 3.5 x 8 x 3.5	250	-	\$0.36	\$0.32	-	\$0.44	\$0.36
230809	Petite	8 x 4 x 10 x 4	250	-	\$0.37	\$0.34	-	\$0.45	\$0.40
230914	Vanity	10 x 5 x 13 x 5	250	-	\$0.44	\$0.41	-	\$0.55	\$0.50
231315	Celebrity	13 x 6 x 15.5 x 6	250	-	\$0.50	\$0.47	-	\$0.57	\$0.55
231611	Fashion	16 x 6 x 12 x 6	250	-	\$0.49	\$0.46	-	\$0.58	\$0.56
231619	Saville	16 x 6 x 19 x 6	200	\$0.63	-	\$0.58	\$0.71	-	\$0.66
231819	Universal	18 x 6 x 19 x 6	200	\$0.72	-	\$0.70	\$0.91	-	\$0.87
230513	Wine Shopper	5.25 x 3.5 x 13	250	-	\$0.53	\$0.49	-	\$0.53	\$0.50



Celebrity Universal Petite Fashion Saville

FOIL PRINT
 <1000 - 20¢ each
 >1000 - 18¢ each

INK PRINT
 <1000 - 18¢ each
 >1000 - 16¢ each

DIGITAL PRINT
 99¢ each
 minimum 300 bags



Tri-fold Handle Paper Bags

CODE	SIZE (inches)	CASE	PRICE/EACH	
			250+	1000+
A 23080912T	8.25 x 4.75 x 11.5	250	\$0.36	\$0.34
B 23091412T	10 x 5 x 13.25	250	\$0.42	\$0.39
C 23161112T	16 x 6 x 12.5	250	\$0.47	\$0.43

Kraft Merchandise Die Cut Bags

Reinforced foldover handle plus side gusset.

CODE	SIZE (inches)	CASE	PRICE/EACH
23081275	8 x 2 x 12	500	\$0.306
23101575	10 x 2 x 15	500	\$0.337
23141875	14 x 4 x 18	250	\$0.483

Kraft and White Paper Merchandise Bags

CODE	SIZE (in)	CASE	75 - Kraft	00 - White
			PRICE/EACH	PRICE/1000
230609	6 x 9	2000	\$0.032	\$0.042
230710	7 x 10	500	\$0.059	\$0.071
230912	9 x 12	500	\$0.071	\$0.106
231114	11 x 14	500	\$0.094	\$0.141
231316	13 x 16	500	\$0.118	\$0.188

DIGITAL PRINT
 99¢ each
 minimum 300 bags

INK PRINT
 <1000 - 18¢ each
 >1000 - 16¢ each

FOIL PRINT
 <1000 - 20¢ each
 >1000 - 18¢ each

SIZES

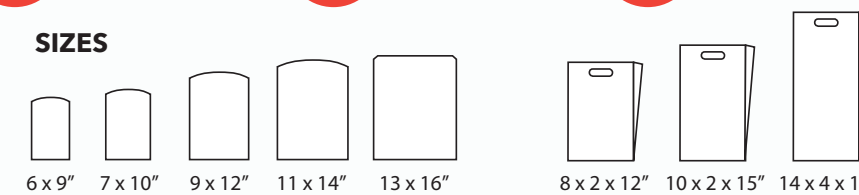

Full Colour Digital Printing

*Prints on all reusable and paper bags we sell!

- low minimums (300 bags)
- no plate charges

Add to any bag* for just 0.99¢ each (min. 300 bags)



Please allow 2 - 3 weeks for printed items from approved art.

SPECIAL ORDER

Pinstripe on Kraft



Tints on Kraft



Enlarged to show pinstripe.



Prime

Petite

Petite

Fashion



Tints and Pinstripe on Kraft

CODE	TYPE	SIZE (Inches)	CASE	PRICE/EACH		
				200+	250+	1000+
230508 __(_)	Prime	5.25 x 3.5 x 8.25 x 3.5	250	–	\$0.52	\$0.44
230809 __(_)	Petite	8.25 x 4.25 x 10.75 x 4.25	250	–	\$0.49	\$0.42
231611 __(_)	Fashion	16 x 6 x 12.5 x 6	250	–	\$0.54	\$0.46
231619 __(_)	Saville	16 x 6 x 19 x 6	200	\$0.79	–	\$0.67



FOIL PRINT
<1000 - 20¢ each
>1000 - 18¢ each



INK PRINT
<1000 - 18¢ each
>1000 - 16¢ each



Saville

Celebrity

Petite



Vanity

Fashion

Petite

Floating Flake

CODE	TYPE	SIZE (inches)	CASE	PRICE/EACH		
				200+	250+	500+
23081012SK	Petite	8 x 4 x 10 x 4	250	–	\$0.59	\$0.54
23131512SK	Celebrity	13 x 6 x 15.5 x 6	250	–	\$0.66	\$0.59
23161912SK	Saville	16 x 6 x 19 x 6	200	\$0.79	–	\$0.71



FOIL PRINT
<1000 - 20¢ each
>1000 - 18¢ each



INK PRINT
<1000 - 18¢ each
>1000 - 16¢ each



FOIL PRINT
<1000 - 20¢ each
>1000 - 18¢ each



INK PRINT
<1000 - 18¢ each
>1000 - 16¢ each

Damask Paper Shoppers

CODE	TYPE	SIZE (inches)	CASE	PRICE/EACH	
				100+	1000+
23080915D	Petite	8 x 4 x 10 x 4	100	\$0.55	\$0.48
23101315D	Vanity	10 x 5 x 13 x 5	100	\$0.59	\$0.51
23161215D	Fashion	16 x 6 x 12 x 6	100	\$0.69	\$0.59

SPECIAL ORDER

Please allow 2 - 3 weeks for printed items from approved art.

Gingham Print



Tints on Kraft

Pinstripe on Kraft



Gloss Claycoat on White



FOIL PRINT
<1000 - 20¢ each
>1000 - 18¢ each

All bag sizes available in these colours.



FOIL PRINT
<1000 - 20¢ each
>1000 - 18¢ each



Tints, Pinstripe on Kraft, Gingham Print, and Gloss Claycoat on White

CODE	TYPE	SIZE (Inches)	CASE	PRICE/EACH		
				200+	250+	1000+
230508 __(_)	Prime	5.25 x 3.5 x 8.25 x 3.5	250	–	\$0.69	\$0.58
230809 __(_)	Petite	8.25 x 4.25 x 10.75 x 4.25	250	–	\$0.60	\$0.51
231611 __(_)	Fashion	16 x 6 x 12.5 x 6	250	–	\$0.76	\$0.64
231619 __(_)	Saville	16 x 6 x 19 x 6	200	\$0.93	–	\$0.79

San Francisco Shoppers

Uncoated Gloss Paper, Twist Handle

- 100% recyclable, biodegradable
- Minimum order is 100 per size



Matching 2-Piece Berkeley Nest Boxes in 4 Sizes
See page 32 for more information.

CODE	TYPE	SIZE (inches)	CASE	PRICE/EACH	
				100 +	1000 +
A 245803 __	Small	7 x 3 x 7 x 3	100	\$0.69	\$0.62
B 245804 __	Medium	10 x 4 x 10 x 4	100	\$0.92	\$0.81
C 245811 __	Large	16 x 6 x 12 x 6	100	\$1.23	\$1.06

All print orders subject to \$30 set-up charge. Applicable artwork, and plate charges may apply. See page 126.



Best prices in the country for printed paper shoppers!

1) PICK A BAG SIZE

Sizes shown are (standard):
Width x Side Gusset x Height



NO PLATE CHARGES!

• All custom orders subject to +/- 20% over/under run

Prime
5.25" x 3.5" x 8.25"

Petite
8" x 4" x 10"

Vanity
10" x 5" x 13"

Celebrity
13" x 6" x 15.5"

Fashion
16" x 6" x 12"

Saville
16" x 6" x 19"

Universal
18" x 6" x 19"

Wine
5.25" x 3.5" x 13"

2) PICK A PRINT COLOUR

- Red: PMS 485
- Blue: PMS 299
- Dk Green: PMS 350
- Black
- Brown: PMS 476
- Burgundy: PMS 208
- Navy: PMS 295
- Yellow: PMS 012

Metallic Colours

- Metallic Silver: PMS 877
- Metallic Gold: PMS 871
- Metallic Copper: PMS 876

Don't see the colour you want?
Send us a pantone # and we'll match at no extra charge!

**5,000 Petite Kraft Shoppers
\$2110.00 printed!**

**5,000 Petite White Shoppers
\$2210.00 printed!**

Simply Paper Shoppers

Kraft with paper twist handles, print 1 colour on 2 sides <25%

STOCK NUMBER	TYPE	SIZE (inches)	CASE PACK	PRICE/EACH		Any 2 Sizes Min. 3000 per size
				5,000	10,000	
23050812GC	Prime	5.25 x 3.5 x 8.25	250	\$0.349	\$0.321	\$0.399
23080912GC	Petite	8 x 4 x 10	250	\$0.422	\$0.374	\$0.474
23091412GC	Vanity	10 x 5 x 13	250	\$0.417	\$0.389	\$0.499
23131512GC	Celebrity	13 x 6 x 15.5	250	\$0.496	\$0.461	\$0.616
23161112GC	Fashion	16 x 6 x 12	250	\$0.456	\$0.428	\$0.499
23161912GC	Saville	16 x 6 x 19	200	\$0.566	\$0.524	\$0.649
23181912GC	Universal	18 x 6 x 19	200	\$0.578	\$0.537	\$0.670
23051312GC	Wine	5.25 x 3.5 x 13	250	\$0.386	\$0.355	\$0.484

White with paper twist handles, print 1 colour on 2 sides <25%

STOCK NUMBER	TYPE	SIZE (inches)	CASE PACK	PRICE/EACH		Any 2 Sizes Min. 3000 per size
				5,000	10,000	
23050800GC	Prime	5.25 x 3.5 x 8.25	250	\$0.392	\$0.375	\$0.457
23080900GC	Petite	8 x 4 x 10	250	\$0.442	\$0.417	\$0.496
23091400GC	Vanity	10 x 5 x 13	250	\$0.523	\$0.485	\$0.617
23131500GC	Celebrity	13 x 6 x 15.5	250	\$0.631	\$0.578	\$0.720
23161100GC	Fashion	16 x 6 x 12	250	\$0.578	\$0.537	\$0.649
23161900GC	Saville	16 x 6 x 19	200	\$0.753	\$0.698	\$0.858
23181900GC	Universal	18 x 6 x 19	200	\$0.765	\$0.711	\$0.874
23051300GC	Wine	5.25 x 3.5 x 13	250	\$0.477	\$0.431	\$0.553

- Minimum 5,000 per size or any 2 sizes, minimum 3000 per size
- Add a second colour for just \$0.04/ea
- For 100% ink coverage, add \$0.029/ea
- Add a rope handle for just \$0.08/ea



INK PRINT

One colour included in the price of the bag



FOIL PRINT

Add \$0.06/ea. per side

Design your own bag online with our interactive **MyDesign™** tool!
www.gunthermele.com



Simply Bags
We can customize to any size bag you require - just ask!

All print orders subject to \$30 set-up charge. Applicable artwork, and plate charges may apply. See page 126.

Please allow 2 - 3 weeks for printed items from approved art.

IN STOCK

IN STOCK

Please allow 2 - 3 weeks for printed items from approved art.



Foil Printed Merchandise Bags

- Constructed of 1.75 mil low density poly
- Minimum order is 1,000 per size printed, minimum one case pack, unprinted.
- Foil Printing is available on one side only and is included in the price of the printed bags
- Die charge extra
- For no-print option please add N to code number.

CODE	TYPE	SIZE (inches)	CASE PACK	PRICE/EACH		
				1000 Foil Print	3000 Foil Print	1000 No Print
* 220609 __	Notion	6 x 9	1000	\$0.22	\$0.15	\$0.10
* 220811 __	Die Cut	8.25 x 11	1000	\$0.27	\$0.20	\$0.15
* 221114 __	Die Cut	11 x 14	1000	\$0.29	\$0.23	\$0.16
221418 __	Die Cut	14.5 x 18	1000	\$0.37	\$0.32	\$0.19
221721 __	Patch	16.5 x 20 + 4	500	\$0.46	\$0.40	\$0.23
222024 __	Patch	20 x 24 + 4	500	\$0.65	\$0.59	\$0.27

* Gold available in 3 sizes only



FOIL PRINT
 <1000 - 20€ each
 >1000 - 18€ each

Celestial Pattern High Density Poly

- Minimum order one case pack

No printing available.

CODE	TYPE	SIZE (inches)	CASE	PRICE/EACH
A 55091241C	Merchandise	9 x 12	1000	\$0.12
B 55141841C	Merchandise	14 x 18 + 3	1000	\$0.24
C 55081041C	Petite Shopper	8 x 4 x 10 x 4	250	\$0.54
D 55161241C	Fashion Shopper	16 x 6 x 12 x 6	250	\$0.75
E 55161941C	Saville Shopper	16 x 6 x 19 x 6	250	\$0.90

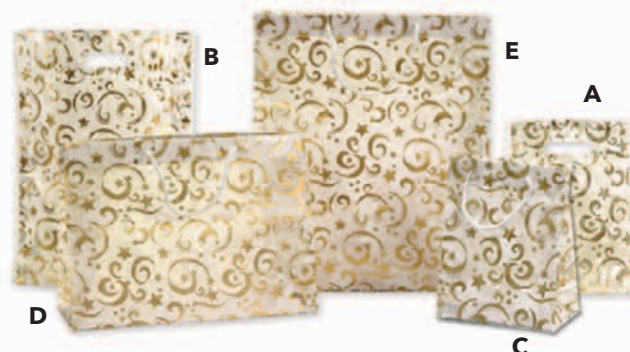

Applicable artwork, and plate charges may apply. See page 126.



Shoppers



Merchandise bags

Frosted Clear Bags

• Minimum order one case pack

CODE	TYPE	GAUGE	SIZE (in)	CASE	PRICE/EACH
A 55091200E	Merchandise	2.0	9 x 12	1000	\$0.10
B 55141800E	Merchandise	2.0	14 x 18 + 3	1000	\$0.24
C 55081000E	Petite Shopper	3.0	8 x 4 x 10 x 4	250	\$0.44
D 55161200E	Fashion Shopper	3.0	16 x 6 x 12 x 6	250	\$0.63
E 55181600E	Majestic Shopper	3.0	18 x 6 x 16 x 6	250	\$0.69

FOIL PRINT
 <1000 - 20€ each
 >1000 - 18€ each

Frosted Brights Translucent Bags

• Minimum order one case pack



FOUR fresh frosty colours to choose from!



CODE	TYPE	GAUGE	SIZE (in)	CASE	PRICE/EACH
A 550912 __	Merchandise	2.0	9 x 12	1000	\$0.10
B 551418 __	Merchandise	2.0	14 x 18 + 3	1000	\$0.24
C 550810 __	Petite Shopper	3.0	8 x 4 x 10 x 4	250	\$0.42
D 551612 __	Fashion Shopper	3.0	16 x 6 x 12 x 6	250	\$0.58
E 551816 __	Majestic Shopper	3.0	18 x 6 x 16 x 6	250	\$0.65

FOIL PRINT
 <1000 - 20€ each
 >1000 - 18€ each

All print orders subject to \$30 set-up charge. Applicable artwork, and plate charges may apply. See page 126.



Poly-Merchandise Bags

Easy to Order - Follow our four easy steps on the next page!

Large or small, we've got a bag for you!

Choose a loop handle for drawstring for just \$40/1000



CODE	SIZE (in)	White or Clear Poly: PRICE/EACH			Coloured Poly: PRICE/EACH			STANDARD PRINT SIZE
		3,000	5,000	10,000	3,000	5,000	10,000	
550912	9 x 12	N/A	\$0.129	\$0.108	N/A	\$0.136	\$0.112	6" wide
551114	11 x 14	N/A	\$0.147	\$0.135	N/A	\$0.152	\$0.137	7" wide
551216	12 x 16 + 3	N/A	\$0.183	\$0.161	N/A	\$0.189	\$0.168	8" wide
551416	14 x 16 + 3	\$0.2930	\$0.233	\$0.199	\$0.2990	\$0.241	\$0.211	10" wide
551720	17 x 20 + 4	\$0.3620	\$0.290	\$0.256	\$0.3740	\$0.299	\$0.268	12" wide
551816	18 x 16 + 4	\$0.3320	\$0.266	\$0.233	\$0.3430	\$0.274	\$0.243	13" wide
552020	20 x 20 + 4	\$0.3890	\$0.313	\$0.278	\$0.4230	\$0.341	\$0.307	14" wide
552024	20 x 24 + 4	\$0.4360	\$0.352	\$0.315	\$0.4510	\$0.387	\$0.330	14" wide

- Constructed of 1.5 mil gauge poly
- Minimum quantity 5,000 (small sizes)/ 3,000 (large sizes)
- Print two sides in 1 ink colour (maximum 25% ink coverage)

No Plate Charges* *Does not include process plates.

5000 Printed Bags for only \$680.00

white 9" x 12" printed 1 colour, 2 sides with fold over die cut handles



INK PRINT

One colour included in the price of the bag

1) PICK A BAG MATERIAL

Low Density LDPE

The most common poly material used in bags. This material has a softer feel than High Density and offers greater tensile strength, clarity and flexibility.

High Density HDPE

Is twice as strong as Low Density poly and feels stiff in comparison with little stretchability. This unique material allows bags to be produced with either a translucent (frosty) appearance or a solid opaque look.



Consider adding our oxo-biodegradable option.

Add 10% to price.

3) PICK A BAG COLOUR**

- White
- Grey: PMS CG2
- Charcoal: PMS CG9
- Red: PMS 485
- Brown: PMS 1545
- Burgundy: PMS 506
- Navy: PMS 296
- Green: PMS 350
- Dusty Rose: PMS 507
- Kraft: PMS 466
- Sage Green: PMS 624
- Mint: PMS 351
- Black
- Yellow: PMS Yellow
- Ivory: PMS 1205
- Purple: PMS 267
- Peach: PMS 149
- Orange: PMS 021
- Pink: PMS 176
- Lilac: PMS 256
- Blue: PMS 300
- Teal: PMS 327

Don't see the colour you want? Send us a pantone number and we'll match at no extra charge!

2) PICK YOUR BAG SIZES & HANDLE STYLE

Sizes shown are Width x Height + Bottom Gusset

STANDARD SIZES

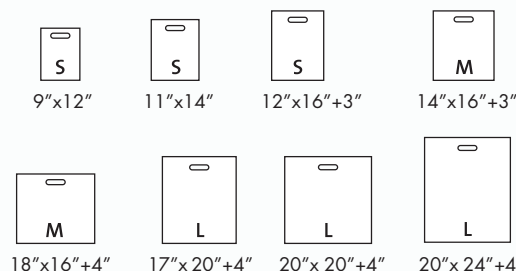

HANDLE STYLES



4) PICK AN INK COLOUR

- Red: PMS 485
- Dk Green: PMS 350
- Brown: PMS 476
- Navy: PMS 295
- Blue: PMS 299
- Black
- Burgundy: PMS 208
- Yellow: PMS 012

Metallic Colours (add \$0.01 each)

- Metallic Gold: PMS 871
- Metallic Silver: PMS 877
- Metallic Copper: PMS 876

Get Creative!

Add more print colours for just \$0.04 each

- All custom orders subject to +/- 20% over/under run
- **Add 15% for metallic gold or silver bag colours.

Design your own bag online with our interactive **MyDesign™** tool!
www.gunthermele.com



We can customize to any size bag you require - just ask!

All print orders subject to \$30 set-up charge. Applicable artwork, and plate charges may apply. See page 126.



Printed Poly Shopping Bags

Customize simply and affordably.

CODE	TYPE	White or Clear Poly: PRICE/EACH			Coloured Poly: PRICE/EACH			STANDARD PRINT SIZE
		3,000	5,000	10,000	3,000	5,000	10,000	
550907	Small Gift	\$0.390	\$0.314	\$0.292	\$0.397	\$0.319	\$0.298	5" wide
550414	Wine	\$0.523	\$0.409	\$0.388	\$0.590	\$0.451	\$0.419	2.5" wide
550810	Petite	\$0.434	\$0.349	\$0.327	\$0.443	\$0.357	\$0.333	5" wide
551612	Fashion	\$0.762	\$0.596	\$0.561	\$0.749	\$0.614	\$0.576	9" wide
551816	Majestic	\$0.894	\$0.735	\$0.693	\$0.923	\$0.758	\$0.714	10" wide

Simply Make It Yours!

No Plate Charges*

*Does not include process plates.

**3000 Printed Shopping Bags
for only \$1302.00**

white, petite: 8" x 4" x 10" x 4" printed 1 colour, 2 sides with loop handles



INK PRINT

One colour included in the price of the bag

- Print two sides in 1 ink colour (maximum 25% ink coverage)
- Constructed of 3.0 mil high density poly
- Coordinating poly loop handles included in price
- Poly Shoppers minimum quantity 3,000 per size

1) PICK A BAG SIZE

Sizes shown are (standard):
Width x Side Gusset x Height
x Bottom Gusset

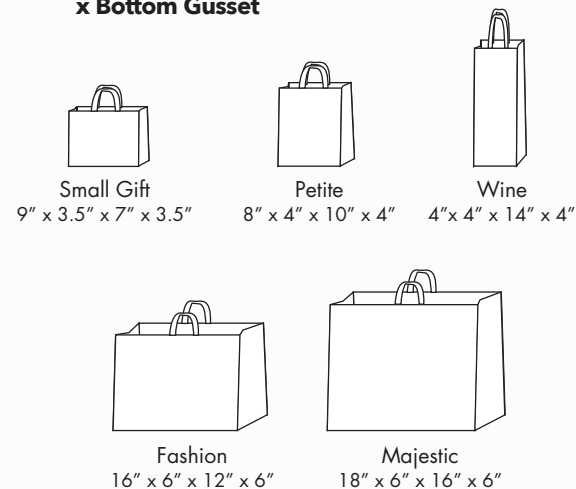

2) PICK A HANDLE STYLE

Loop
(included)



Die Cut
(no charge)



Rope, Cotton or Poly
(add \$0.081/ea)



Tube
(add \$0.090/ea)



Consider adding our
oxo-biodegradable option.
Add 10% to price.

3) PICK A BAG COLOUR



Don't see the colour you want? Send us a pantone number and we'll match at no extra charge!

4) PICK AN INK COLOUR

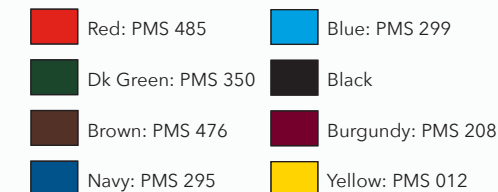

Metallic Colours (add \$0.01 each)

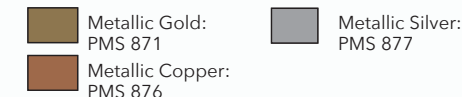

Get Creative!

Add more print colours for just \$0.04 each

- All custom orders subject to +/- 20% over/under run
- **Add 15% for metallic gold or silver bag colours.

Design your own bag online with our interactive **MyDesign™** tool!
www.gunthermele.com



We can customize to any size bag you require - just ask!

Please allow 2 - 3 weeks for printed items from approved art.

IN STOCK

SPECIAL ORDER

Please allow 3 - 5 weeks for printed items from approved art.



Toronto Totes

 <1000 - 20¢ each
>1000 - 18¢ each

CODE	DESCRIPTION	SIZE (inches)	PACK	PRICE/EACH	
				100+	1000+
A 215909 __	Small Tote	9 x 5 x 12 x 5	100	\$1.41	\$1.28
B 215916 __	Large Tote	16 x 6 x 14 x 6	100	\$1.84	\$1.68

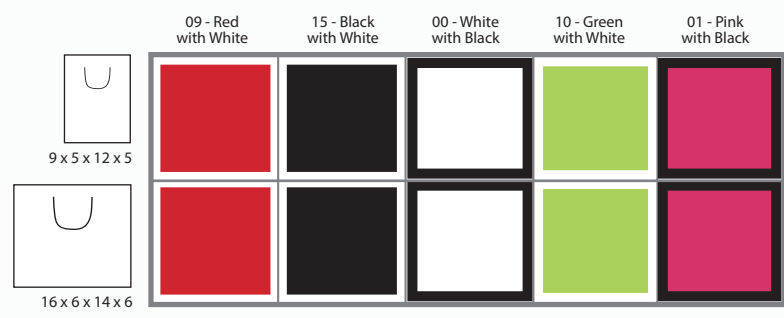

CODE	DESCRIPTION	SIZE (inches)	PACK	PRICE/EACH	
				100+	1000+
A 21141600S	Four Seasons Tote	14 x 4 x 16 x 4	100	\$2.00	\$1.58
B 21141615WF	Winter Forest Tote	14 x 6 x 16 x 6	100	\$2.00	\$1.58
C 21141616B	Bamboo Fabric Tote	14 x 4 x 16 x 4	100	\$2.62	\$2.17
D 21111315BW	Six Bottle Wine Tote	11.5 x 7.25 x 13 x 7.25	100	\$2.26	\$1.69
E 21141629	Two-tone Non-woven Tote	14 x 6 x 16 x 6	100	\$1.91	\$1.45
F 21081075C	Small Kraft Composite Tote	8 x 4 x 10 x 4	100	\$0.99	\$0.89
G 21141675C	Large Kraft Composite Tote	14 x 6 x 16 x 6	100	\$1.29	\$1.19
H 21141615B	Black Tote with 4" gussett	14 x 4 x 16 x 4	100	\$1.74	\$1.20
I 21141655B	Black Tote with 8" gussett	14 x 8 x 16 x 8	100	\$1.88	\$1.37
J 21141609R	Red Tote with 8" gussett	14 x 8 x 16 x 8	100	\$1.91	\$1.40
K 60161612	Foldable Bag with zipper	16 x 16 x 4	24	\$1.99	\$1.89
L 22161601	Pink Polyester Foldable Bag	16 x 16	100	\$1.59	\$1.19

-  **FOIL PRINT**
<1000 - 20¢ each
>1000 - 18¢ each
-  **SCREEN PRINT**
<500 is 60¢/bag,
>500 is 50¢/bag,
>1000+ is 40¢/bag.
Silk screen set-upcharge \$65.00
-  **DIGITAL PRINT**
99¢ each
minimum 300 bags
-  **PAD PRINT**
<500 is 22¢ each
>500 is 20¢ each



 **FOIL PRINT**
<1000 - 20¢ each
>1000 - 18¢ each

CODE	DESCRIPTION	SIZE (inches)	PACK	PRICE/EACH	
				100+	1000+
21580541	Large Metallic Fuchsia Tote	15.5 x 6 x 14.25 x 6	100	\$2.64	\$2.22

Metallic Reusable Tote



1) PICK A MATERIAL:

Non-woven Polypropylene

Soft, yet durable. Use this for light to medium weight loads.

Woven Polypropylene

Our strongest material. This rigid weave will handle heavy items.

Recycled P.E.T. (100% post consumer)

Recycled water and soda bottles are the main source of P.E.T. plastic used to weave this material. Strong, soft and enviro-friendly.

2) PICK A BAG SIZE



9 x 4 x 12 x 4"



11.5 x 7 x 13 x 7"



14 x 4 x 16 x 4"



16 x 5 x 16 x 5"

3) CREATE A GRAPHIC IMAGE

Submit your own design or let our graphics team create a unique look for you!

Full Colour Laminated Reusable Bags

Convey your message vividly. See next page for options!



NEW! LOWER MINIMUM ORDER QUANTITY - 2,000 bags	NON-WOVEN POLYPROPYLENE PRICE/EACH		WOVEN POLYPROPYLENE PRICE/EACH	
	2,000	5,000	2,000	5,000
Shopping Bags (inches)				
9 x 4 x 12 x 4	\$1.59	\$1.05	\$1.59	\$1.05
11.5 x 7 x 13 x 7	\$1.79	\$1.25	\$1.79	\$1.25
14 x 4 x 16 x 4	\$1.99	\$1.39	\$1.99	\$1.39
16 x 5 x 16 x 5	\$2.09	\$1.46	\$2.09	\$1.46

Many more sizes available - just ask!

- Plates extra: \$695.00 per design
 Additions:
 • Zipper top for \$0.25/bag
 • Gusset print: \$0.10/bag
 • Add matte lamination for just \$0.04/bag
 • Add a carded bottom for \$0.05/bag



For greater strength - Add a coordinating nylon webbing handle at no extra charge.



We can customize to any size bag you require - just ask!

ADDITIONAL FOIL PRINT 14¢ each Lead time 12-14 weeks



Embossed Laminated Reusable Bags



Add some sparkle, style, shimmer and shine with these NEW fashionable totes!

- Price includes hotstamp on one side
- Available in two sizes
- Minimum 5000 per size

SIZE (inches)	Price/each
8 x 4 x 10 x 4	\$1.29
14 x 4 x 16 x 4	\$1.85

- | | | | | | |
|---|------------------------|---|--------------------------|---|----------------------------|
| A | BG126 - Black Emboss | D | YB016 - Silver/Snakeskin | G | YB002 - Steel Grey |
| B | YB018 - Gold/Snakeskin | E | AY002 - Matte Red | H | BY002 - Met. Copper/Orange |
| C | BG017 - Pink Squares | F | AL001 - Holographic | I | AG034 - Black PU |



Fabric Style Shoppers



1) PICK A BAG SIZE

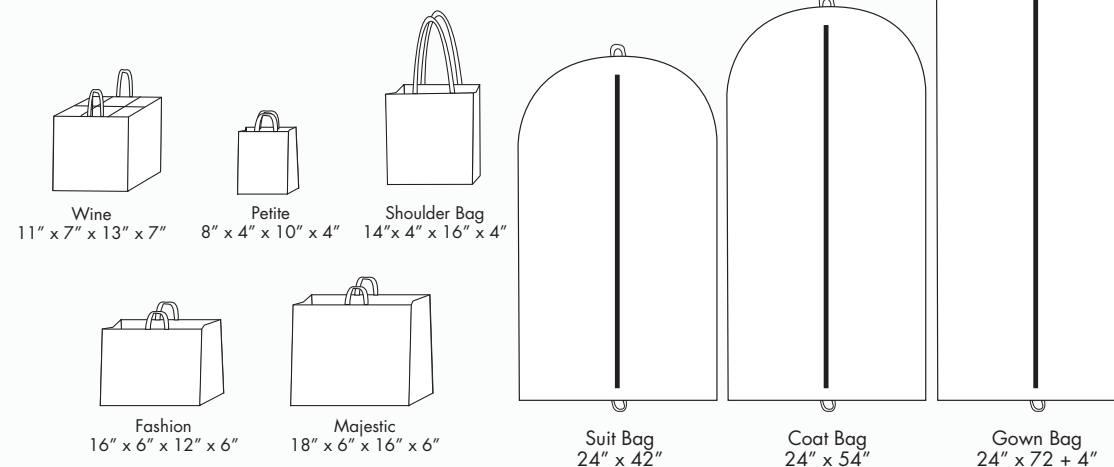

Reusable Fabric Style Shoppers

SIZE (inches)	TYPE	PRICE/EACH	
		1,000	3,000
11 x 7 x 13 x 7	Wine (6 bottle)	\$1.95	\$1.46
8 x 4 x 10 x 4	Petite	\$1.58	\$1.33
14 x 4 x 16 x 4	Shoulder Bag	\$1.79	\$1.43
16 x 6 x 12 x 6	Fashion	\$1.69	\$1.37
18 x 6 x 16 x 6	Majestic	\$2.00	\$1.58
24 x 42	Suit Bag	\$2.27	\$2.14
24 x 54	Coat Bag	\$2.92	\$2.48
24 x 72 + 4	Gown Bag	\$4.38	\$4.09

NO PLATE CHARGES!

Pricing includes printing on one side with one colour.

- 75gm non-woven
- Minimum custom print order is 1,000 bags
- Choose from these 8 popular sizes
- Price includes screen print, 1 colour, one side



This bottle carrier has a divided section.

For in stock reusable totes, see page 98.

Get the custom look starting at just 1,000 minimum.



We can customize to any size bag you require - just ask!



SILK SCREEN
One colour included in the price of the bag

2) PICK A BAG COLOUR



3) PICK A PRINT COLOUR

- Blue: PMS 299
- Navy: PMS 295
- Dk. Green: PMS 350
- Lime: PMS 584
- Brown: PMS 476
- Black
- Yellow: PMS 012
- Orange: PMS 021
- Red: PMS 485
- Burgundy: PMS 208
- Pink: PMS 204
- Metallic Silver: PMS 877
- Metallic Copper: PMS 876
- Metallic Gold: PMS 871

Don't see the print colour you want? Send us a pantone # and we'll match at no extra charge!

Please allow 2 - 3 weeks for printed items from approved art.

IN STOCK

IN STOCK

Please allow 2 - 3 weeks for printed items from approved art.



- **NEW!** Necklace Folder - see page 31
- Eurotote - see page 78
- Tissue - see page 108

Diamond Ice

Contemporary style with clean and curved edges.

- 2-piece acrylic with pearl or bronze paper backing
- Packaged in a coordinating 2-piece outer box
- Minimum 12 per style

CODE	DESCRIPTION	SIZE (inches)	PRICE /EACH	
			12+	144+
36321 _ _ _ _	Ring	2.36 x 2.36 x 2.16	\$7.02	\$5.98
36322 _ _ _ _	Earring	2.36 x 2.36 x 2.16	\$7.02	\$5.98
36383 _ _ _ _	T-pad	3.30 x 3.30 x 3	\$10.68	\$9.54
36350871B	Watch - Bronze only	4 x 4 x 3.75	\$11.76	\$10.56



871B-Bronze



001P - Pearl

FOIL PRINT
 <500 - 20€ each
 >500 - 18€ each

PAD PRINT
 Add your logo to the lid.
 <500 is 22€ each
 >500 is 20€ each

001P - Pearl



- Eurototes - see page 79
- Ribbon - see page 116
- Wrapping paper - see page 110



E-Commerce Jewellery Boxes

Deliver the 'in-store' experience to your customer's door

See page 34 for more information

Velocity

Boxes with ribbons for an elegant finish.

- Taupe or Black paper wrap boxes with white velour pads and white or brown organza ribbon
- Packaged in individual white sleeves
- Imprint available on inside lid
- Minimum 1 case pack



273 - Taupe



153 - Black

CODE	DESCRIPTION	SIZE (inches)	CASE	PRICE/EACH	
				25+	1000+
31221 _ _ _ _	Ring	2.5 x 2.25 x 2	50	\$1.75	\$1.44
31283 _ _ _ _	Utility	3 x 3 x 2	50	\$2.41	\$2.00
31293 _ _ _ _	Bracelet	9 x 2.25 x 1.5	25	\$3.32	\$2.72
31273 _ _ _ _	Necklace	6.25 x 8 x 2	25	\$4.35	\$3.78

FOIL PRINT
 <500 - 20€ each
 >500 - 18€ each

PAD PRINT
 Add your logo to the lid.
 <500 is 22€ each
 >500 is 20€ each

153 - BLACK



All print orders subject to \$30 set-up charge. Applicable artwork, and plate charges may apply. See page 126.

All print orders subject to \$30 set-up charge. Applicable artwork, and plate charges may apply. See page 126.

Please allow 2 - 3 weeks for printed items from approved art.

IN STOCK

IN STOCK

Available for immediate shipment.



Romance

An easy-tie ribbon and contrasting edge reveal.

- Ivory with tan paper wrap boxes with white velour pads and organza ribbon
- Packaged in individual white sleeves • Minimum 1 case pack



CODE	DESCRIPTION	SIZE (inches)	CASE	PRICE/EACH	
				50+	1000+
31221863	Ring	2.5 x 2.25 x 2	100	\$1.58	\$1.44
31222863	Earring	2 x 1.5 x 1.187	100	\$1.51	\$1.29
31263863	Utility	3 x 3 x 2.125	100	\$1.80	\$1.55
31293863	Bracelet	9 x 2.375 x 1.5	50	\$2.63	\$2.23
31273863	Necklace	6.375 x 8 x 2	50	\$3.46	\$3.06



FOIL PRINT
 <500 - 20¢ each
 >500 - 18¢ each



PAD PRINT
 Add your logo to the lid.
 <500 is 22¢ each
 >500 is 20¢ each



Shadow

Two piece charcoal and silver paperboard box with a recessed wave.

- White flocked foam pads • Imprint available inside or on top of lid
- Minimum one case pack



CODE	DESCRIPTION	SIZE (inches)	CASE	PRICE/EACH	
				50+	1000+
31511308	Charm	2 x 2 x 1	50	\$1.16	\$0.97
31521308	Ring/Earring	2 x 2 x 1.75	50	\$1.42	\$1.13
31563308	Pendant/Earring	3.5 x 3.5 x 1.25	50	\$2.05	\$1.57
31593308	Bracelet	9 x 2 x 1	50	\$2.87	\$2.44
31573308	Necklace	6 x 6 x 1.5	50	\$4.34	\$3.38



FOIL PRINT
 <500 - 20¢ each
 >500 - 18¢ each



PAD PRINT
 Add your logo to the lid.
 <500 is 22¢ each
 >500 is 20¢ each

All print orders subject to \$30 set-up charge. Applicable artwork, and plate charges may apply. See page 126.

In Stock Jewellery Displays

Platforms, Risers, Trays and Matching Jewellery Stands. Available in Chalk Vienna Leatherette



In Stock Window Display (VAN-SC-WIN-KIT-SC as pictured above) consists of:

- | | | | |
|-----------------|---------------------|------------------|---------------|
| (1) DAWS02-SC | Window platform set | (2) DA80060UR-SC | Ring stand |
| (1) DADB225-SC | Bracelet arch | (2) DA80059UR-SC | Ring stand |
| (1) DAJP350V-SC | Bangle pillow | (1) DA321S-SC | Signage block |
| (2) DACES12-SC | Earring stands | (3) DARF110-SC | Ring fingers |
| (1) DACES32-SC | Earring stand | (1) DANF1022-SC | Neck form |
| (1) DACH01-SC | Single hoop earring | (1) DANF1020-SC | Neck form |
| (2) DA350P-SC | Pendant stand | | |
| (2) DA225P-SC | Pendant stand | | |

\$499.00 /as shown

SEE OUR COMPLETE SELECTION:

www.gunthermele.com/in-stock-jewelry-displays/

Nest Boxes

Please allow 2 - 3 weeks for printed items from approved art.

IN STOCK

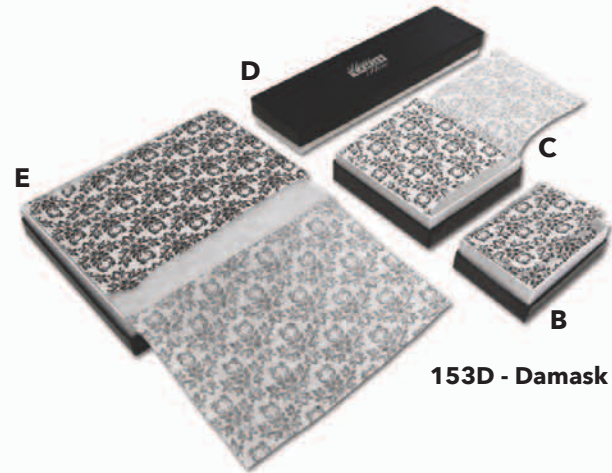

153D - Damask



103 - White Economy

CODE	DESCRIPTION	CASE SIZE (inches)	PACK	PRICE/EACH WHITE ECONOMY		PRICE/EACH DAMASK	
				50+	1000+	100+	1000+
A 31502103	Charm	2.5 x 1.5 x .875	100	\$0.53	\$0.47	N/A	N/A
B 31570 ___	Earring	3 x 2.125 x 1	100	\$0.59	\$0.50	\$0.61	\$0.53
C 31555 ___	Brooch	3.5 x 3.5 x 1	100	\$0.68	\$0.60	\$0.73	\$0.62
D 31564 ___	Bracelet	8 x 2 x .875	100	\$0.76	\$0.68	\$0.85	\$0.74
E 31558 ___	Necklace	6 x 5 x 1	100	\$0.98	\$0.88	\$1.24	\$1.05
F 31576103	Large Necklace	8 x 5.5 x 1.25	50	\$1.51	\$1.31	N/A	N/A
G 31259103	Stand-Up Bangle	3.5 x 2 x 2 x 2	100	\$1.96	\$1.76	N/A	N/A

Minimum order is one case pack



FOIL PRINT
<500 - 20€ each
>500 - 18€ each

PAD PRINT
Add your logo to the lid.
<500 is 22€ each
>500 is 20€ each

Nest Boxes

Estimated Lead Time - Please allow 3 weeks for unprinted items and 4 weeks for printed items from approved art.

SPECIAL ORDER



Our paperboard boxes are made with 100% recycled board



Eco-Friendly 100% recycled board colours + FSC paper wraps.



SOLID COLOURS! MIX AND MATCH!



ECO FRIENDLY



019 - White Sand 020 - Moss

Cotton Filled Nest Boxes

SOLID COLOUR & ECO FRIENDLY PRICE/EACH

CODE	SIZE (inches)	CASE PACK	50+	1000+
310110 ___*	1.75 x 1.125 x .625	100	\$0.66	\$0.46
310210 ___	2.5 x 1.5 x .875	100	\$0.69	\$0.48
310320 ___	3 x 2.125 X 1	100	\$0.75	\$0.52
310330 ___	3.5 x 3.5 x 1	100	\$0.91	\$0.64
310360 ___	3.5 x 3.5 x 1.5	100	\$1.00	\$0.72
310340 ___	3.5 x 3.5 x 2	100	\$1.10	\$0.81
310530 ___	5.25 x 3.75 x .875	100	\$1.05	\$0.74
310650 ___	6 x 5 x 1	50	\$1.49	\$1.04
310820 ___	8 x 2 x .875	100	\$0.99	\$0.70
310850 ___*	8 x 5.5 x 1.25	50	\$1.89	\$1.31

* These sizes are available in these colours only: 00K, 007, 015, 15P, 060, 075, 076.

Nest Boxes

Estimated Lead Time - Please allow 3 weeks for unprinted items and 4 weeks for printed items from approved art.

SPECIAL ORDER

Berkeley Nest Boxes

- Please allow 3 weeks for unprinted boxes, 4 weeks for printed boxes
- White flocked platform inserts
- Contemporary styling matches our San Francisco Shoppers
- Available in seven colours and four sizes
- Minimum 1 case pack

CODE	SIZE (inches)	CASE	PRICE/EACH	
			100+	1000+
A 32201 ___	3 x 3 x 1.25	100	\$1.19	\$1.12
B 32202 ___	3.5 x 3.5 x 2	100	\$1.29	\$1.22
C 32203 ___	5 x 5 x 1	100	\$1.50	\$1.41
D 32204 ___	9 x 4.5 x 2	100	\$1.95	\$1.83



849 - Red 192 - Solid White 613 - Slate Grey 231 - Black



138 - White 548 - Fuchsia 916 - Aqua

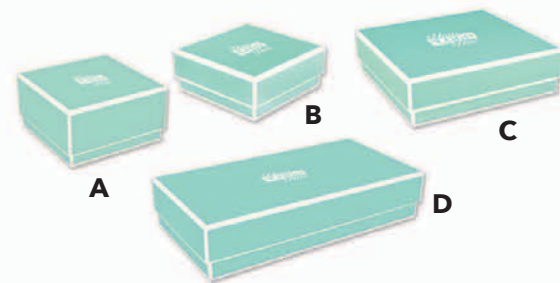

FOIL PRINT
<500 - 20€ each
>500 - 18€ each

PAD PRINT
Add your logo to the lid.
<500 is 22€ each
>500 is 20€ each

These boxes match our San Francisco Shoppers! See page 89.



All print orders subject to \$30 set-up charge. Applicable artwork, and plate charges may apply. See page 126.

All print orders subject to \$30 set-up charge. Applicable artwork, and plate charges may apply. See page 126.

Please allow 2 - 3 weeks for printed items from approved art.

IN STOCK

SPECIAL ORDER

Estimated Lead Time - Please allow 3 weeks for unprinted items and 4 weeks for printed items from approved art.



Gift Cards Not Included.

Black Gift Card Box with Ribbon

31040315

4 x 3 x .625

\$1.76 each (50+)

\$1.34 each (1000+)

Case packs of 100



FOIL PRINT
<500 - 20¢ each
>500 - 18¢ each

Minimum order is one case pack.
Applicable artwork, and plate charges may apply See page 126.

Pewter Gift Card Box with Ribbon

31040742

7.5 x 4.25 x .625

\$2.42 each (50+)

\$2.28 each (1000+)

Case packs of 50



FOIL PRINT
<500 - 20¢ each
>500 - 18¢ each

Minimum order is one case pack.
Applicable artwork, and plate charges may apply. See page 126.

Pillow Boxes

- Perfect for charms and beads
- Available in 2 colours and sizes
- Minimum 100 per size and colour



FOIL PRINT
<500 - 20¢ each
>500 - 18¢ each

CODE	SIZE (inches)	CASE	PRICE/EACH	
			100+	1000+
A	32040309 - Red & White	4 x 3.75 x 1.75	100	\$0.30 \$0.24
B	32030209 - Red & White	3 x 2.5 x 1	100	\$0.23 \$0.19
C	32030215 - Black & White	3 x 2.5 x 1	100	\$0.23 \$0.19

Minimum order is one case pack.
Applicable artwork, and plate charges may apply. See page 126.

Salon or Spa Folder

CODE	SIZE (inches)	CASE	PRICE/EACH	
			100+	1000+
45060800	Space for Spa Menu and Gift Card	100	\$1.19	\$0.86

Finished and folded size: 6.875" x 8.5"



FOIL PRINT
<500 - 20¢ each
>500 - 18¢ each

Gift Certificate and Box

CODE	SIZE (inches)	PRICE/EACH	
		CASE	100+
09221001	Generic Gift Certificate with Ivory Box 6.625 x 3.25 x .5"	100	\$1.55
09221001B	Ivory Gift Certificate Box Only	100	\$0.90
18199	Generic Gift Certificate Only 6.375 x 3.125" folded	100	\$0.65



FOIL PRINT
<500 - 20¢ each
>500 - 18¢ each

Dress it up with printed ribbon!
See page 118.



Gift Card Box

- White paperboard platforms.
- Interior has same paper for lids and bases.

CODE	SIZE (inches)	CASE	PRICE/EACH
			100+
313230 __	3.5 x 2.25 x .75"	100	\$0.80

Gift Certificate and Box

CODE	SIZE (inches)	CASE	PRICE/EACH
			100+
0922100 _	Generic Gift Certificate with Box	100	\$1.55
0922100 _ B	Gift Certificate Box Only see color options 6.625 x 3.25 x .5"	100	\$0.90

Gift Certificate Box Colour:



Minimum order is one case pack.



FOIL PRINT
<500 - 20¢ each
>500 - 18¢ each



PAD PRINT
Add your logo to the lid.
<500 is 22¢ each
>500 is 20¢ each



Interior of gift certificate shows printability and can be numbered.



Available to finish the look of your gift certificate/card.

Stretch Loops (100 pack min.)

- 09500607 **6"** - Gold **\$0.147/ea**
- 09500608 **6"** - Silver **\$0.147/ea**
- 09501007 **10"** - Gold **\$0.157/ea**
- 09501008 **10"** - Silver **\$0.157/ea**



Dress it up with printed ribbon!
See page 118.



All print orders subject to \$30 set-up charge. Applicable artwork, and plate charges may apply. See page 126.

All print orders subject to \$30 set-up charge. Applicable artwork, and plate charges may apply. See page 126.

Please allow 2 - 3 weeks for printed items from approved art.

IN STOCK

IN STOCK

Please allow 2 - 3 weeks for printed items from approved art.

Microfibre Pouches

• Minimum case pack 100

CODE	COLOUR	SIZE (inches)	PRICE /EACH	
			100+	500+
09040315	Black	4 x 3	\$0.99	\$0.87
09050415	Black	5-1/2 x 4	\$1.48	\$1.25
09050412	Brown	5-1/2 x 4	\$1.48	\$1.25
09040311	Blue	4 x 3	\$0.99	\$0.87
09050411	Blue	5-1/2 x 4	\$1.48	\$1.25



Geo Pouches

Brushed ivory pouches with boxes that match our Geo hinged boxes on page 18.

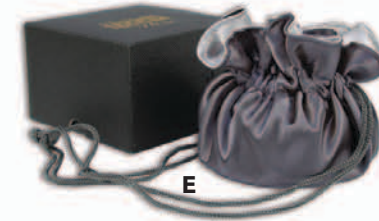

432C - Cobalt

415B - Black

456P - Purple

427T - Bronze

Reversible Satin Pouch

Foil print on top of the lid. Matching 2-piece printable outer box. Pouch has round base 2.75" dia. x 3" high



Microfibre Bell Pouches

Available in black only.



Damask Pouches

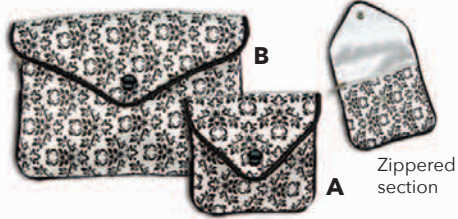

Envelope Pouches

w/Snap Closure
Available in black. Packaged in a two piece, pearlized, dark grey outer box.

Gold Metallic Pouch



White Leatherette Pouches



Velveteen Pouches



- Black - 615
- Royal Blue - 611
- Brown - 612
- Green - 667
- Burgundy - 666

Wedding Pouches



White satin pouch with a white 2 piece outer box.

• Minimum case pack of 100

CODE	TYPE	SIZE (inches)	PRICE /EACH	
			100+	1000+
A 09030315D	Small Damask Pouch	3 x 3	\$1.52	\$1.38
B 09040515D	Large Damask Pouch	5.5 x 4	\$2.37	\$1.94
C 09203715	Small Envelope Pouch	2.375 x 2.75	\$1.69	\$1.55
D 09304715	Large Envelope Pouch	3 x 4	\$2.19	\$2.07
E 09314807	Gold Metallic Pouch	3 x 4	\$0.59	\$0.47
F 09203700	Small White Leatherette Pouch	2.75 x 3.25	\$0.59	\$0.53
G 09314700	Large White Leatherette Pouch	3 x 4	\$0.83	\$0.72
H 09405 ___	*Velveteen Pouches	4 x 5.5	\$0.83	\$0.56
I 09314 ___	*Velveteen Pouches	3 x 4	\$0.68	\$0.46
31314003	White 2 piece outer box	3.25 x 4.25	\$0.55	-
31541003	White 2 piece outer box	4.5 x 6	\$0.59	-
J 37501006	White Wedding Pouches	1.875 x 2.5	\$0.97	\$0.78

* See photo for colour code

Economical packaging for inexpensive items or repairs.

FOIL PRINT
<500 - 20¢ each
>500 - 18¢ each

PAD PRINT
Add your logo to the lid.
<500 is 22¢ each
>500 is 20¢ each

SPECIAL ORDER

Organza Pouches

Allow 2 - 3 Weeks for delivery. Can be foil printed.

Organza Colours Colours not exactly as shown.

Black - 030	Silver - 012	White - 029
Hunter - 589	Navy - 370	Smoke Blue - 337
Lt. Blue - 305	Burgundy - 276	Ultra Violet - 467
Purple - 465	Lavender - 430	Copper - 073
Orange - 750	Olive - 563	Mint - 530
Red - 250	Pink - 115	Gold - 690
Baby Maize - 617	Ivory - 810	Mauve - 161
Pastel Green - 513	Fruit Punch - 155	Yellow - 645
Turquoise - 340	Royal - 350	Fuchsia - 187

A is only available in Silver, White, Pink, Lavender, Gold and Ivory.

F not available in Fruit Punch, Orange, Royal, Turquoise and Yellow.

G is only available in Silver, White, Pink, Red, Burgundy, Lt. Blue, Royal, Lavender, Mint, Olive, Gold and Ivory.

CODE	SIZE (inches)	PRICE /EACH	
		100+	1000+
A 09905 ___	2 x 2.5	\$0.36	\$0.29
B 09910 ___	3 x 4	\$0.38	\$0.30
C 09915 ___	4 x 5.5	\$0.49	\$0.40
D 09920 ___	5 x 6.5	\$0.57	\$0.46
E 09925 ___	5.5 x 9	\$0.84	\$0.68
F 09930 ___	6 x 14	\$0.99	\$0.80
09950 ___	22 x 25 (not shown)	\$3.26	\$2.60

Minimum 100 per size/colour.

FOIL PRINT
<500 - 20¢ each
>500 - 18¢ each



All print orders subject to \$30 set-up charge. Applicable artwork, and plate charges may apply. See page 126.

All print orders subject to \$30 set-up charge. Applicable artwork, and plate charges may apply. See page 126.

Cleaning Supplies



Blitz™ - Ultra Sonic Machine with non toxic Gem & Jewellery concentrate and microfibre polishing cloth. Single tank, battery operated unit (4 AA batteries not included). Place jewellery in baskets and immerse into tank, switch on for a 3-5 minute cleaning.

Ideal for cleaning Gold, Platinum, Diamonds, Ruby, Sapphire, Topaz, Amethyst, Aquamarine, Garnet, Peridot and other non-porous gems and non glued gems.

04201600 \$34.99 each



Blitz™ - Ultra Sonic Machine Gem & Jewellery Concentrate

Non toxic. Ideal for cleaning Gold, Platinum, Diamonds, Ruby, Sapphire, Topaz,

Amethyst, Aquamarine, Garnet, Peridot and other non-porous gems and non glued gems.

04201600C \$1.39 each

Minimum order is 12 pieces.



Non-toxic and effective for everyday use.

Buy 144 and we'll customize for **FREE!**

Metallic gold and silver is limited to printing on black, blue, green, brown, violet and wine backgrounds.

Full Colour Printed Labels

Choose from print colours below or create your own full colour look. Please allow 6 - 8 weeks for custom printed items from approved art. Minimum order is 144 jars.

Customize with your store brand!
144 - 236ml Jars for just \$3.99 each

CODE	DESCRIPTION	PRICE/EACH 144+
04651000C	Private Label Gem Jewel Cleaner	\$3.99

LABEL COLOURS:



PRINT COLOURS:



Full Colour Microfibre Cleaning Cloths

- Please allow 6 - 8 weeks for printed items from approved art.
- Minimum order is 2500 cloths.

04060800C
6" x 8"
\$1.36/ea. (2500+) **\$0.99/ea. (5000+)**

Customizable Jewellery Care Cloths

Please allow 4 - 6 weeks for custom printed cloths. Minimum Order is 144 cloths.

CODE	SIZE (inches)	PRICE
04966800C	6 x 8 (envelope)	\$3.75/ea
04981000C	8 x 10 (poly bag)	\$4.99/ea
04912150C	12 x 15 (poly bag)	\$6.39/ea
04961700C	11 x 14 (boxed)	\$6.99/ea

PRINT COLOURS:



Gem & Jewellery Cleaner is ideal for cleaning Gold, Platinum, Diamonds, Ruby, Sapphire, Topaz, Amethyst, Aquamarine, Garnet, Peridot and other non-porous gems.

24 per case pack
04651000 \$3.95 each
236 ml



Foamz™ is the same Gem and Jewellery Cleaner that you have used and trusted for decades in an easy-to-use foam. Foamz™ is formulated to clean and restore Diamonds and other precious gemstone jewellery to their original brilliance.

12 per case pack
04657000 \$6.99 each
75 ml



Silver Shine is designed to remove tarnish from silver jewellery in seconds by utilizing a revolutionary new electrochemical process and is packaged in a wide mouth jar to easily clean larger pieces of silver jewellery.

12 per case pack
04681000
\$7.49 each
3 trays



Silver Care Polish traditional, non-abrasive, silver polishing cream

12 per case pack
04618000
\$6.25 each
236 ml



Delicate Gem & Pearl Cleaner is formulated to gently clean and restore the luster to Emerald, Ivory, Onyx, Opal, Pearl, Turquoise, Lapis, Coral, Malachite and other porous gems.

24 per case pack
04671000 \$4.12 each
236 ml



Watch Care Kit cleans and polishes all watches and bands (gold, silver, stainless steel or leather).

12 per case pack
04620462 \$14.00/ea



Jewellery Care Cloth 11" x 14" two ply cloth made from 100% soft cotton. The interior is thoroughly treated with the finest cleaning and polishing agents with tarnish inhibitors to clean, shine and protect.

12 per case pack
04961700 Jewellery Care
\$6.90/ea

04961800 Silver Care
\$6.90/ea



Gem & Jewellery Cleaner Concentrate

A) 3.78 litres 10:1
04654000 \$44.00/ea

B) 236 ml 5:1
04653000 \$5.70/ea



Handling Gloves

White microfibre
One size fits all

The natural oils in our skin can often leave displeasing marks on jewellery. Our microfibre, lint-free gloves are ideal for handling and protecting your most precious inventory.

05000296
\$2.50/pair
minimum order - 6 pairs

Vellum Enveloped Cleaning Cloths



Light Blue Diamond & Gem Cloths

Please allow 4 - 6 weeks for custom printed cloths from approved art. Minimum Order is 144 cloths.

04780800C | 8 x 8" Blue cloth | \$3.99/ea

Microfibre Cloth removes small dust, oily film, fingerprints and other residue from fine jewellery. Chemical Free. Lint Free. AVAILABLE IN LIGHT BLUE ONLY.

Please allow 2 - 3 weeks for printed items from approved art.

IN STOCK

IN STOCK

Please allow 2 - 3 weeks for printed items from approved art.

Non-Woven Garment Covers

Great for resale or promotions!

CODE	SIZE (inches)	CASE	PRICE/EACH	
			PLAIN	SCREEN PRINTED
A 21244015	24 x 42	100	\$2.49	\$2.99
B 21245415	24 x 54	100	\$3.59	\$4.09
C 21247215	24 x 72 + 4	100	\$4.89	\$5.39

Silk screen set-up charge: \$65.00



SCREEN PRINT

<500 is 60¢/bag,
>500+ is 50¢/bag,
>1000+ is 40¢/bag.
Silk screen set-upcharge \$65.00

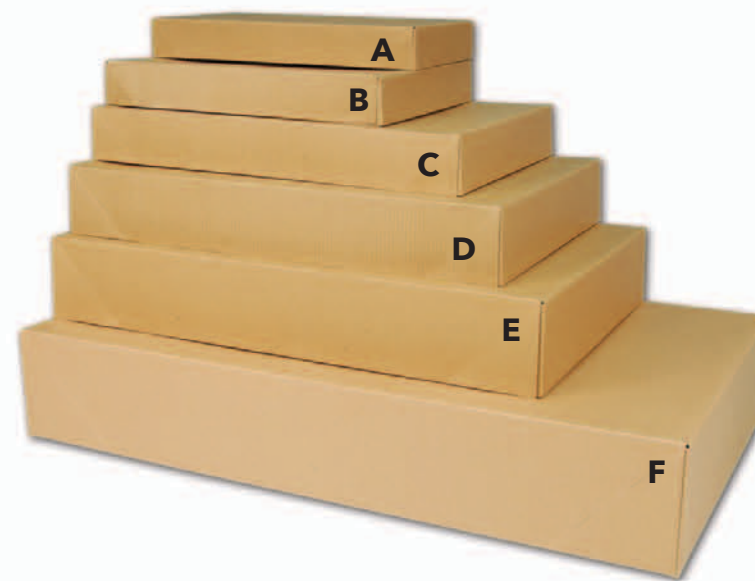

IN STOCK COLOURS

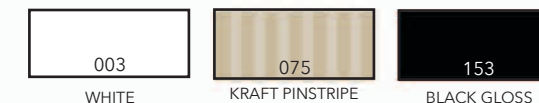

SPECIAL ORDER COLOURS

Please allow 3-5 weeks for printed boxes from approved art.

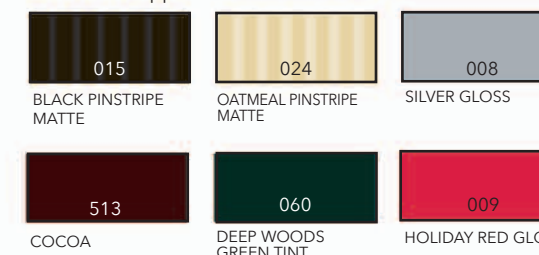

See below for delivery times.

SPECIAL ORDER

Non-Woven Garment Covers Custom Colours Available

Please allow 12 - 14 weeks from approved art for delivery.

Minimum 1000 per size.

SIZE	DESCRIPTION	PRICE/EACH	
		1000	3000
24 x 42	Suit Bag	\$2.69	\$2.06
24 x 54	Coat Bag	\$3.25	\$2.44
24 x 72 + 4	Gown - Black	\$4.93	\$4.13

Pricing includes printing on one side with one colour.



Poly Garment Covers on Rolls

Please allow 6 - 8 weeks from approved art for delivery. Minimum 5 rolls per size.

CODE	DESCRIPTION	SIZE (inches)	PRICE/ROLL			
			White/1 print colour		Coloured/1 print colour	
			5 ROLLS	10 ROLLS	5 ROLLS	10 ROLLS
212140 __	Suit 450/roll	21 x 3 x 40	\$292.00	\$240.00	\$434.00	\$342.00
212154 __	Coat 333/roll	21 x 3 x 54	\$292.00	\$240.00	\$434.00	\$342.00
212173 __	Dress 250/roll	21 x 3 x 72	\$292.00	\$240.00	\$434.00	\$342.00



One roll, white with no print for \$215.00 any size.

21214000S, 21215400S, 21217300S

Colours available: White 00, Black 15, Gray 08, Ivory 16, Beige 39, Navy 11, Green 10
Print colours available: Black, Blue, Brown, Burgundy, Red, Green, Orange, Yellow
Metallic Print - Add \$29.00/roll
1.0 mil LDPE. Minimum 5 rolls, printed or plain.

Apparel Boxes

• Minimum order quantity is one case pack

Seven sizes and nine colours to choose from!

CODE	DESCRIPTION	SIZE (inches)	WHITE OR KRAFT PINSTRIPE			COLOURS		
			CASE PACK	PRICE /EACH 100+	1000+	CASE PACK	PRICE /EACH 100+	1000+
A 32072 ___	Glove/Sock*	11-1/2 x 5-1/2 x 1-1/2	100	\$0.63	\$0.55	-	-	-
B 32073 ___	Lingerie/T-Shirt	11-1/2 x 8-1/2 x 1-5/8	100	\$0.69	\$0.59	100	\$0.91	\$0.81
C 32075 ___	Shirt	15 x 9-1/2 x 2	100	\$0.78	\$0.63	100	\$1.11	\$0.96
D 32076 ___	Sweater/Dress	17 x 11 x 2-1/2	50	\$1.11	\$0.96	50	\$1.51	\$1.37
E 32077 ___	Jacket/Robe	19 x 12 x 3	50	\$1.32	\$1.29	50	\$1.75	\$1.54
F 32078 ___	Coat/Gown	24 x 14 x 4	25	\$2.41	\$2.20	25	\$2.99	\$2.73
G 32071 ___	Sweater (white only) (not shown)	15 x 11 x 4-1/2	50	\$1.51	\$1.37	-	-	-

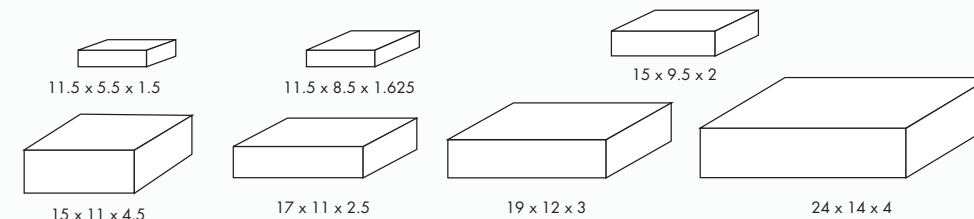

FOIL PRINT

<1000 - 20¢ each
>1000 - 18¢ each
minimum charge \$28.80



INK PRINT

<1000 - 18¢ each
>1000 - 16¢ each
minimum charge \$28.80



White Folding Gift Boxes

- Our most economical option.
- Ships flat and stores flat.

CODE	DESCRIPTION	SIZE (inches)	CASE	PRICE/EACH	
				100 +	1000 +
32058003	G58 Baby Mugs	3.5 x 3.5 x 2	100	\$0.23	\$0.20
32001003	G1 Mugs	4 x 4 x 4	100	\$0.24	\$0.21
32002003	G2 Cups and Saucers	6 x 6 x 4	100	\$0.34	\$0.30
32043003	G43 Bowls, etc.	10 x 8 x 4	100	\$0.46	\$0.43
32033003	G33 Bowls, etc.	10 x 10 x 6	50	\$1.13	\$0.99
32005003	G5 Teapots, etc.	8 x 8 x 5	100	\$0.69	\$0.62
32006003	G6 Teapots, etc.	8 x 8 x 8	50	\$1.01	\$0.91
32048003	G48 Fork, Knife, Spoon	13 x 4 x 2	100	\$1.25	\$1.13
32036003	G36 Casseroles	11 x 11 x 4.5	50	\$1.13	\$0.99
32013003	G13 Plates	5 x 5 x 2	100	\$0.33	\$0.28
32004003	G4 Plates	8 x 8 x 2	100	\$0.59	\$0.50
32008003	G8 Plates	11 x 11 x 2	100	\$0.70	\$0.62
32009003	G9 Plates	13.5 x 13.5 x 2	50	\$0.95	\$0.88
32040003	G40 Plates	15 x 15 x 2	50	\$1.24	\$1.12
32049003	G49 Placemats, Trays, etc.	14 x 10 x 4	100	\$1.23	\$1.10
32003003	G3 All purpose	7 x 4 x 3	100	\$0.41	\$0.37
32010003	G10 All purpose	9 x 4.5 x 4.5	100	\$0.45	\$0.40
32038003	G38 All purpose	12 x 4 x 4	100	\$0.57	\$0.52
32041003	G41 All purpose	10 x 7 x 7	100	\$0.88	\$0.83
32051003	G51 All purpose	13 x 6 x 6	50	\$1.20	\$1.09
32039003	G39 Lazy Susans, Large Gifts	15 x 15 x 6	50	\$1.51	\$1.39
32024003	G24 Two Piece Boxes	6 x 6 x 10	100	\$1.46	\$1.32



FOIL PRINT
 <1000 - 20¢ each
 >1000 - 18¢ each



INK PRINT
 <1000 - 18¢ each
 >1000 - 16¢ each
 minimum charge \$28.80

All print orders subject to \$30 set-up charge. Applicable artwork, and plate charges may apply. See page 126.

Tuckit® Folding Gift Boxes



- Our glued boxes fold and tuck together for a solid bottom.
- 15 sizes available

CODE	SIZE (inches)	PACK	ECONO WHITE PRICE/EACH		KRAFT & COLOURS PRICE/EACH		GLOSS COLOURS PRICE/EACH	
			100+	1000+	100+	1000+	100+	1000+
# 334103	3 x 3 x 2	100	\$0.29	\$0.26	\$0.29	\$0.26	N/A	N/A
* 334180	3 x 3 x 3	100	\$0.32	\$0.30	\$0.35	\$0.30	N/A	N/A
334111	4 x 4 x 4	100	\$0.35	\$0.31	\$0.36	\$0.32	\$0.43	\$0.40
334115	6 x 4.5 x 4.5	100	\$0.38	\$0.35	\$0.47	\$0.43	\$0.57	\$0.51
334113	6 x 6 x 4	100	\$0.46	\$0.42	\$0.48	\$0.44	\$0.76	\$0.69
334114	6 x 6 x 6	100	\$0.53	\$0.49	\$0.59	\$0.54	\$0.77	\$0.70
334120	8 x 8 x 3.5	100	\$0.79	\$0.72	\$0.83	\$0.76	\$1.17	\$1.06
334121	8 x 8 x 6	50	\$1.27	\$1.16	N/A	N/A	N/A	N/A
334119	9 x 4.5 x 4.5	100	\$0.64	\$0.58	\$0.67	\$0.60	\$0.80	\$0.73
* 334183	10 x 5 x 4	100	\$0.68	\$0.62	\$0.72	\$0.65	N/A	N/A
334124	10 x 10 x 6	50	\$1.44	\$1.31	\$1.63	\$1.48	\$2.62	\$2.38
334131	12 x 6 x 6	50	\$1.48	\$1.34	\$1.61	\$1.47	\$2.11	\$1.93
334125	12 x 12 x 2.5	50	\$1.00	\$0.91	\$1.17	\$1.06	\$1.82	\$1.66
* 334136	12 x 12 x 5.5	50	\$1.86	\$1.70	\$1.95	\$1.77	\$2.99	\$2.73
• 334186	14 x 6 x 6	50	\$1.18	\$1.03	\$1.78	\$1.62	N/A	N/A

- * not available in purple
- # only available in kraft pinstripe and econo white
- only available in white gloss and kraft pinstripe
- 100% recycled content (min. 35% post consumer) - kraft excluded



FOIL PRINT
 <1000 - 20¢ each
 >1000 - 18¢ each



Bottom tucks into place for a secure fit.



Pop-Up Colour Folding Gift Boxes

- Our most convenient folding gift box.
- Simple automatic bottom closure.

CODE	SIZE (inches)	CASE	PRICE/EACH		153 BLACK	123 BROWN	753 KRAFT	603 GREEN	083 SILVER	003 WHITE
			100 +	1000+						
34058	3 x 3 x 3	100	\$0.28	\$0.27						
34001	4 x 4 x 4	100	\$0.29	\$0.28						
34013	5 x 5 x 3.5	100	\$0.45	\$0.43						
34064	6 x 4.5 x 4.5	100	\$0.46	\$0.44						
34002	6 x 6 x 4	100	\$0.46	\$0.44						
34066	6 x 6 x 6	100	\$0.50	\$0.48						
34003	7 x 4 x 3	100	\$0.51	\$0.49						
34077	7 x 7 x 7	100	\$0.72	\$0.69						
34004	8 x 8 x 2	100	\$0.80	\$0.76						
34088	8 x 8 x 3.5	100	\$0.75	\$0.70						
34005	8 x 8 x 5.5	50	\$0.87	\$0.83						
34006	8 x 8 x 8.5	50	\$1.14	\$1.08						
34010	9 x 4.5 x 4.5	100	\$0.54	\$0.51						
34041	9.75 x 6.75 x 6.75	50	\$0.91	\$0.87						
34008	10.5 x 10.5 x 2 -2PC.	50	\$0.98	\$0.90						
34033	10 x 10 x 6	50	\$1.42	\$1.34						
34026	12 x 6 x 6	50	\$1.42	\$1.34						
34009	12 x 12 x 2.5 -2PC.	50	\$1.07	\$1.02						
34038	12 x 4 x 4	50	\$0.75	\$0.71						
34034	12 x 12 x 5.5 -2PC.	50	\$1.84	\$1.74						
34051	14 x 6 x 6	50	\$1.44	\$1.37						
34039	14 x 14 x 5 -2PC.	25	\$1.93	\$1.83						
34084	8 x 8 x 14 -2PC.	50	\$2.33	\$2.23						

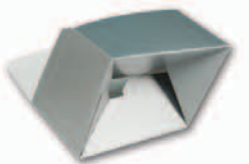
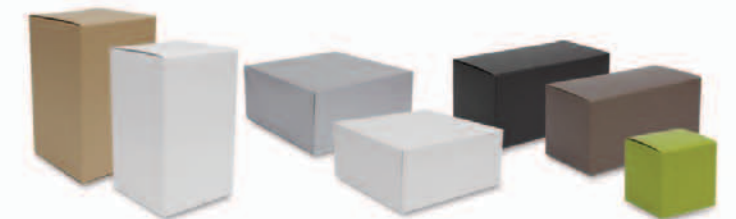

Bottom interlocks for easier assembly.



FOIL PRINT
 <1000 - 20¢ each
 >1000 - 18¢ each

All print orders subject to \$30 set-up charge. Applicable artwork, and plate charges may apply. See page 126.

Deliver the 'in-store' experience to your customer's door.



02B - Light Blue

93C - Charcoal



Four color process print available. Please inquire.

In Stock E-Commerce Gift Boxes

A variety of gift item sizes for your customer's unboxing experience.

- Reversible kraft boxes with grey or light blue interior
- Minimum case pack 25

CODE	DESCRIPTION	SIZE (inches)	PRICE/EACH	
			25+	250+
450606 ___	Small	6 x 6 x 4	\$1.29	\$1.04
451010 ___	Medium	10 x 10 x 6	\$2.89	\$2.31
451015 ___	Large	15 x 10 x 4	\$2.41	\$1.93
451712 ___	X-Large	17 x 12 x 5	\$3.50	\$2.80
451815 ___	XX-Large	18 x 15 x 6	\$4.46	\$3.57

Add a printed label from our in stock selection. See page 122 - 123.



Complete the parcel with our instock tissue. See page 108.



Add a full colour label from our digital print label selection. See page 124 - 125.



Custom E-Commerce Gift Boxes

Go above and beyond to impress customers and exceed their expectations by delivering more than just a product, but also an experience.

SIZE (inches)	Flexo Print - 1 Color PRICE/EACH		
	500	1,000	2500
10 x 6 x 4	\$5.20	\$3.25	\$2.22
11.125 x 8.75 x 4	\$5.69	\$3.65	\$2.60
14.5 x 7.25 x 5	\$5.88	\$3.97	\$2.95
17 x 12 x 4.25	\$6.22	\$4.51	\$3.58
17.125 x 11.125 x 2	\$6.14	\$4.22	\$3.17

Complete the parcel with custom tissue. See page 109.

NO PLATE CHARGES!

Pricing includes printing on one side.

FOIL PRINT
 <500 - 20¢ each
 >500 - 18¢ each
 minimum charge \$28.80

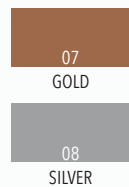
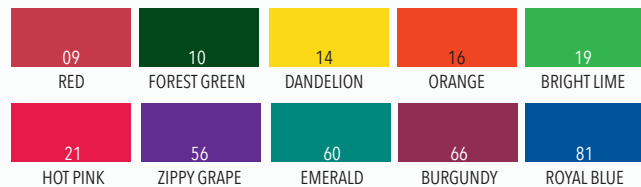

Spotlight Tissue Colours (UNPRINTED)

\$29.99* EVERYDAY

*Except Metallic Colours

CODE	DESCRIPTION	SIZE (in)	Packaged	PRICE/REAM		
				1 - 4 REAMS	5+ REAMS	25+ REAMS
20850100	White Economy	17 x 27	480	\$14.00	\$12.00	\$10.01
208551__G	Spotlight on Value (colours) 20 x 30		480	\$29.99	\$29.99	\$29.99
208559__G	Spotlight on Value (metallic) 20 x 30		200	\$37.00	\$34.00	\$33.00
20850101	#1 White Economy	17 x 13.5	480	\$8.00	\$7.00	\$5.75
20850400	#1 White Bleached	20 x 30	480	\$23.00	\$22.00	\$21.00
20851800	#1 White Bleached	18 x 9 dia.	1 roll	\$80.00/roll		
20852000	#1 White Bleached	20 x 9 dia.	1 roll	\$99.00/roll		



13 in stock tissue colours to choose from. Plus check out our assorted Pre-Packs!



20855901C



20855902C



20855903C



20855904C

Holiday Printed Tissue

Per design: 250 sheets - 20" x 30"

\$19.99/ream

Tissue Pre-Packs

CODE	DESCRIPTION	SIZE (in)	PRICE/PACK
20855100G	Spring Assortment	20 x 30	\$34.00
20855101G	Christmas	20 x 30	\$34.00

Christmas Pre-Pack

Contains 100 of each:
Red, Emerald, Metallic Gold, Metallic Silver.



Spring Assortment

Contains 100 of each:
Green, Lemon, Tangerine, Pink, Blue.

Pick a PMS print colour and we will match it.

For metallic ink print: add 10% to the price above.

For > 50% ink coverage, an additional \$10 per ream.

All custom orders subject to a +/-10% over/under run.

Applicable artwork, set-up and plate charges apply.



INK PRINT

Included in price of tissue

Unprinted, minimum 1 ream (per colour).
Must be ordered in increments of 1 reams.
Ships in approximately 4 - 6 weeks.

SPECIAL ORDER Tissue Colours (PRINTED AND UNPRINTED)

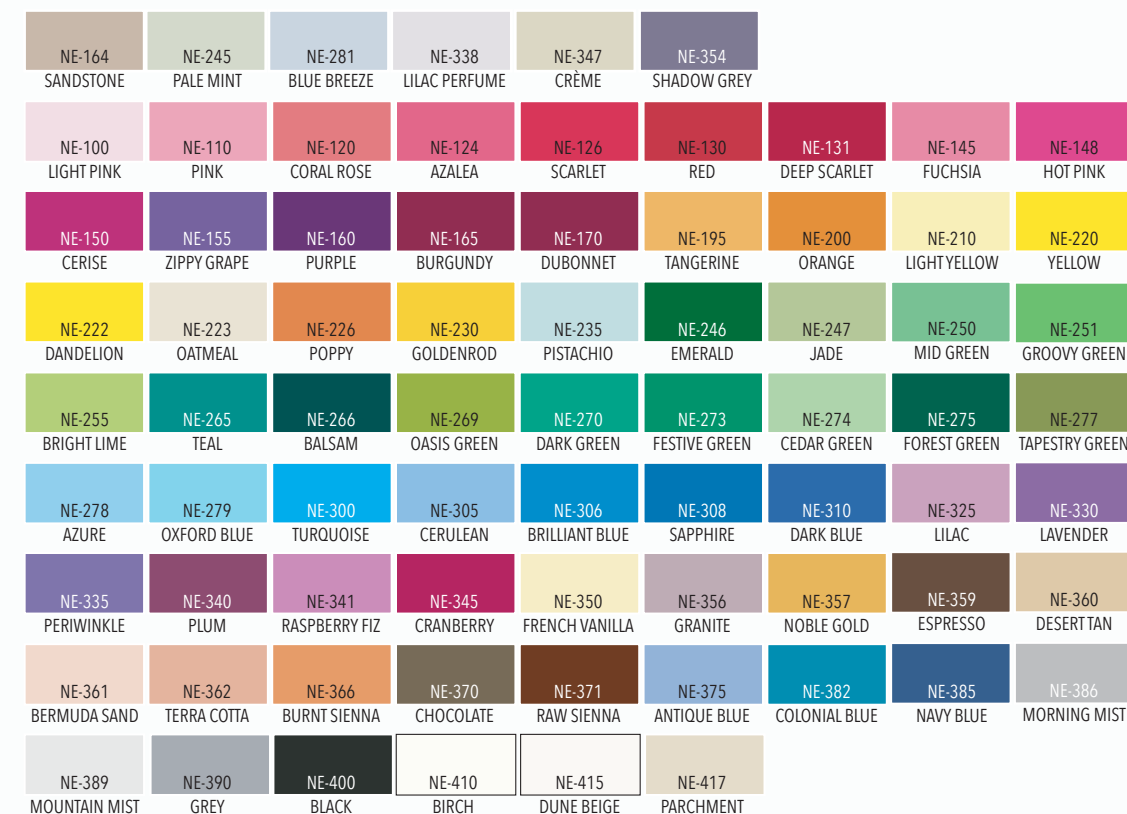

Special Order Tissue - Unprinted

CODE	DESCRIPTION	SIZE (in)	Packaged	PRICE/REAM	
				1 REAM	25+ REAMS
20899__	Special Order Colours	20 x 30	480	\$39.90	\$35.00

CREATE YOUR OWN LOOK

CUSTOM TISSUE

Please allow 6 - 8 weeks for printed items from approved art.



Custom Printed White Tissue - 10 Reams \$860.00

CODE	DESCRIPTION	SIZE (in)	Packaged	PRICE/REAM	
				10 REAMS	30 REAMS
20869000G	White	20 X 30	480	\$86.00	\$77.00
20869000M	Coloured	20 x 30	480	\$113.00	\$99.00
20869000GK	Kraft	20 x 30	480	\$86.00	\$77.00

Minimum 10 reams. Note: Plates extra \$275.00 (per colour).

One colour on white (plate extra).





57657624 57657724 57657024 57657224 57657424 57657124
 57657324 57656424 57651324 57653524 57656724 57656924
 57654624 57655324 57655424 57656124 56300607 57300624 56900407



57605324 57605224 57604324 57604424 57604624 57604724
 57604824 57604924 57605024 57601724 57602224 57602924

Inspirations Gift Wrap

Code # 57 ___ 24 • Paper size: 24" x 417'

\$89.00 per 1/2 REAM ROLL

Inspirations Jewellers Rolls

Code # • Paper size: 8" x 150'

\$37.00/ROLL



Inspirations Giftwrap

By Gunther Mele



57602524 57602524S 57603224 56300107 57300124 56300707 57300724

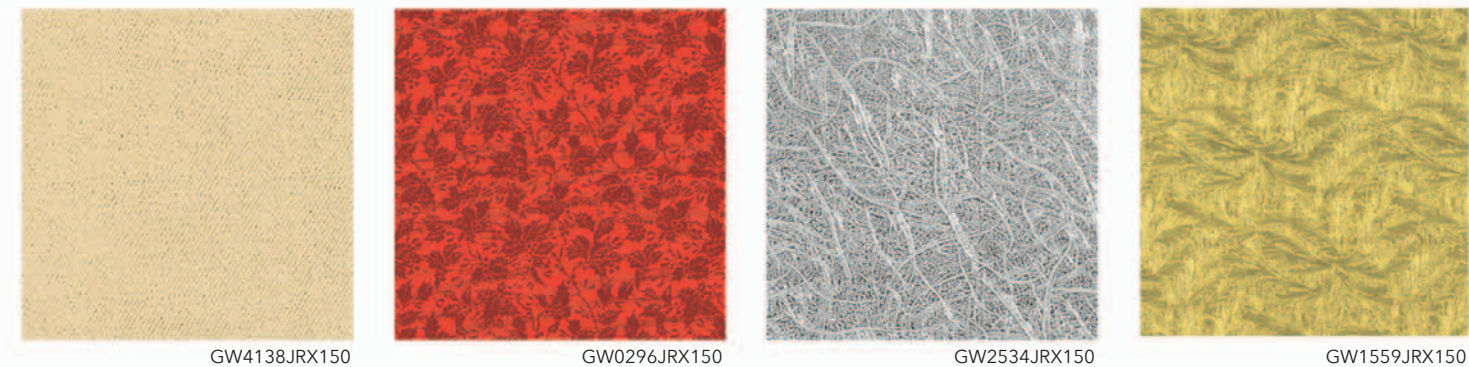

GW4138JRX150 GW0296JRX150 GW2534JRX150 GW1559JRX150



GW0296JRX150 GW0396JRX150 GW1912JRX150 GW8024JRX150

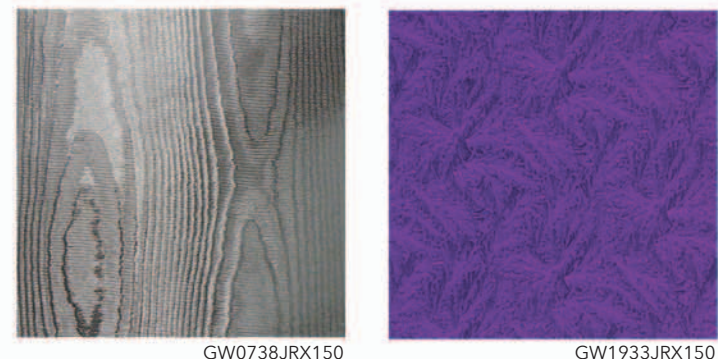

GW0738JRX150 GW1933JRX150

Sullivan Design Works Giftwrap Jewellers Rolls

Size: 7.375" x 150'

\$59.00 per roll



Giftwrap dispenser with serrated edge can be added to your custom jewellers roll order for \$7.00 each. Code: 09715000



Jewellers Rolls: minimum order 1 roll.

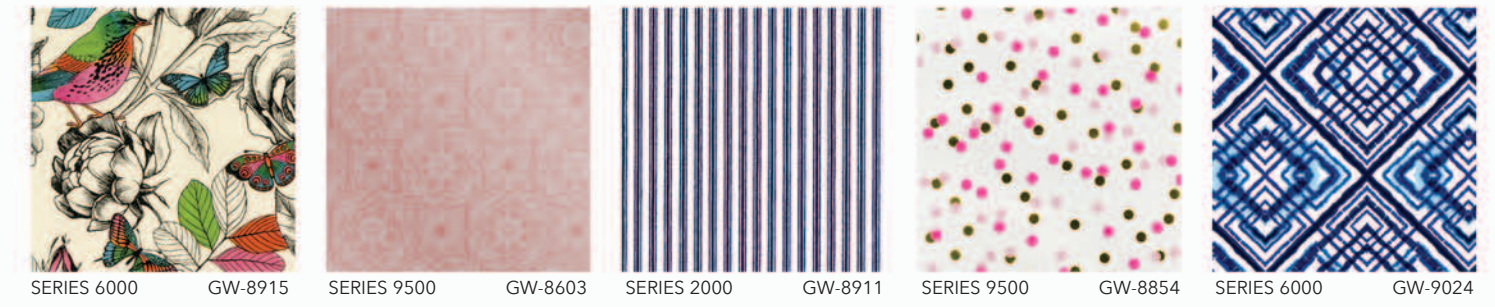

Sullivan Design Works **Seasonal** Gift Wrap

SULLIVAN designs available in 1/2 Ream Rolls and Full Ream Rolls

NOTE: All Sullivan giftwrap orders must include GW design code.

MINIMUM ORDER: 1 Roll of 417' (15" rolls must be ordered in multiples of 2 rolls per design)

SLITTING CHARGE: A slitting charge of \$25.00 applies to each individual roll. (no more than two slits per roll; (2 slits = \$25.00)

View our entire Selection online at GUNTHERMELE.COM

Additional custom order designs available to choose from. Contact your area sales representative for more info.

Sullivan Design Works **Every Day** Gift Wrap

Pricing Level	15H	18H	24H	30H	15F	18F	24F	30F
	Half Ream 15" x 417'	Half Ream 18" x 417'	Half Ream 24" x 417'	Half Ream 30" x 417'	Ream 15" x 833'	Ream 18" x 417'	Ream 24" x 833'	Ream 30" x 833'
1000 Series	\$109.77	\$152.95	\$152.95	\$176.36	\$176.33	\$266.33	\$266.33	\$315.92
2000 Series	\$147.56	\$219.52	\$219.52	\$253.72	\$251.35	\$402.25	\$402.25	\$476.09
5000 Series	\$167.34	\$253.72	\$253.72	\$291.50	\$292.04	\$470.20	\$470.20	\$551.02
6000 Series	\$196.12	\$302.29	\$302.29	\$349.08	\$347.13	\$571.22	\$571.22	\$666.79
7500 Series	\$199.75	\$310.10	\$310.10	\$359.48	\$363.10	\$586.75	\$586.75	\$684.10
9000 Series	\$226.72	\$358.06	\$358.06	\$412.05	\$413.27	\$683.73	\$683.73	\$771.44
9500 Series	\$250.11	\$397.68	\$397.68	\$458.85	\$464.60	\$765.91	\$765.91	\$890.81

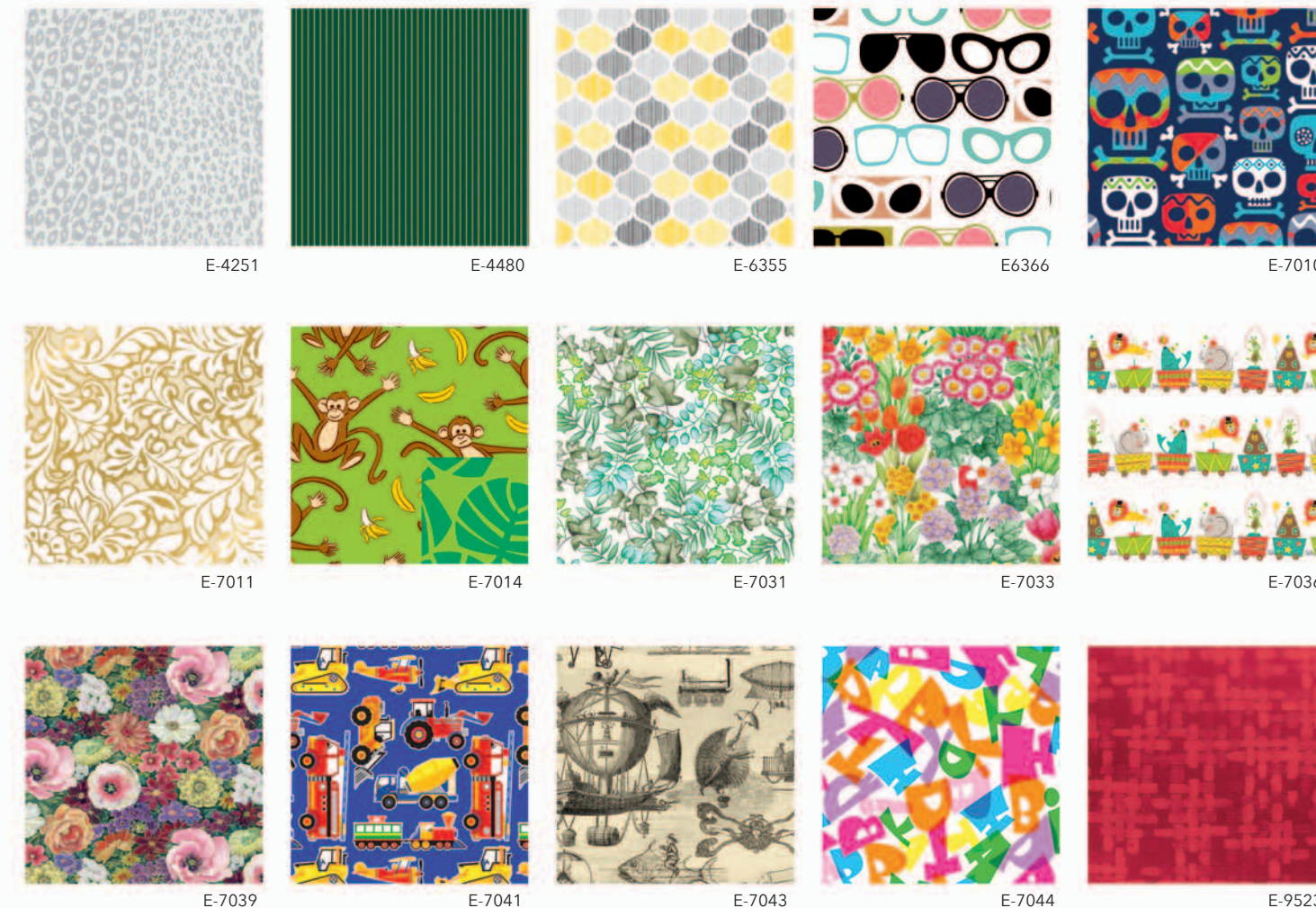

Shamrock Designs **Seasonal** Gift Wrap

Shamrock Designs **Every Day** Gift Wrap

View our entire Selection online at GUNTHERMELE.COM

Shamrock designs available in Cutter Boxes, 1/2 Ream Rolls and Full Ream Rolls

Additional custom order designs available to choose from. Contact your area sales representative for more info.

NOTE: All Shamrock giftwrap orders must include design code.

MINIMUM ORDER: 1 Roll

SLITTING CHARGE: A slitting charge of \$25.00 applies to each individual roll. (no more than two slits per roll - 2 slits = \$25.00)

Jewellers Rolls also available. Most are minimum 3 rolls per design.*

Contact your sales representative for details.* Select designs available in 1 roll minimums.

Pricing Level	7J	24C	18H	24H	30H	36H	18F	24F	30F	36F
	Jewellers Roll 7.375'x100'	Cutter Box 24" x 100'	Half Ream 18" x 417'	Half Ream 24" x 417'	Half Ream 30" x 417'	Half Ream 36" x 417'	Half Ream 18" x 833'	Half Ream 24" x 833'	Half Ream 30" x 833'	Half Ream 36" x 833'
A	\$21.71	\$43.28	\$137.48	\$124.75	\$206.23	\$206.23	\$224.05	\$211.32	\$348.80	\$348.80
B	\$26.70	\$53.47	\$170.58	\$280.06	\$259.69	\$259.69	\$292.79	\$280.06	\$463.37	\$467.37
C	\$31.89	\$63.65	\$196.04	\$183.31	\$302.97	-	\$341.16	\$328.43	\$542.30	-
D	\$34.44	\$68.74	\$211.32	\$198.59	-	-	\$374.26	\$361.53	-	-
E	\$58.56	\$117.12	\$320.80	\$308.07	-	-	\$590.67	\$577.94	-	-

Available for immediate shipment

IN STOCK

IN STOCK

Available for immediate shipment.

Color # Name	Curling Ribbon	2.75" Star Bows	3.75" Star Bows	Splendor Ribbon
00 - White				
86 - Ivory				
29 - Vanilla				
61 - Pastel Yellow				
03 - Yellow				
13 - Daffodil				
14 - Sunshine Yellow				
07 - Gold				
27 - Holiday Gold				
22 - Melon				
73 - Coral				
16 - Tropical Orange				
17 - Orange				
12 - Chocolate				
75 - Baby Pink				
01 - Pink				
80 - Primrose				
57 - Azalea				
09 - Red				
58 - Lava Red				
66 - Burgundy				
41 - Beauty				
59 - Dubonnet Rose				
28 - Orchid				
05 - Lavender				
56 - Purple				
54 - Periwinkle				
74 - Spruce				
60 - Hunter				
77 - Baby Blue				
02 - Light Blue				
48 - Williamsburg Blue				
11 - Royal				
81 - Navy				
71 - Sea Green				
47 - Aqua				
25 - Turquoise				
55 - Robin's Egg				
32 - Caribbean Blue				
84 - Teal				
04 - Mint				
19 - Citrus				
96 - Leaf				
30 - Celadon				
10 - Emerald				
93 - Charcoal				
70 - Antique Silver				
15 - Black				
07 - Metallic Gold				
08 - Metallic Silver				
09 - Metallic Red				
10 - Metallic Green				
99 - Everyday Assortment	N/A			N/A
98 - Christmas Assortment	N/A			N/A

Curling Ribbon

See chart for available colours

CODE	PRICE/ROLL
COLOURS - 3/16" x 500 yards 148373 __	\$3.26
METALLIC - 3/16" x 250 yards 14837807 Gold	\$9.80
14837808 Silver	\$9.80



2.75" Splendor Bows

See chart for available colours

CODE	CASE PACK	PRICE/EACH	
		100+	1000+
COLOURS - 2.75" x 17 loop 142311 __	200	\$0.160	\$0.140
METALLIC - 2.5" x 17 loop 14531107 Gold	200	\$0.178	\$0.157
14531108 Silver	200	\$0.178	\$0.157

Min: case pack



99 - Everyday Assortment



98 - Christmas Assortment



Metallic Bows

3.75" Splendor Bows

See chart for available colours

CODE	CASE PACK	PRICE/EACH	
		100+	1000+
COLOURS - 3.75" x 13 loop 143512 __	200	\$0.165	\$0.147
METALLIC - 3.75" x 17 loop 14551207 Gold	200	\$0.273	\$0.252
14551208 Silver	200	\$0.273	\$0.252

Min: case pack



Splendor Ribbon

See chart for available colours

CODE	PRICE/ROLL
COLOURS - 3/4" x 250 yards 141050 __	\$9.99
METALLIC - 3/4" x 100 yards 140130 __	\$13.72



Matte Wraphia™

CODE	SIZE	PRICE/ROLL
148367 __	100 yds	\$8.70

Perfect Bows™

Minimum: 50 per size, per colour.

CODE	SIZE	PRICE/EACH	
		50+	1000+
140515 __	5.5" Perfect Bow	\$0.650	\$0.580



Mini Metallic Star Bows

252 per tub

CODE	DESCRIPTION	PRICE/TUB
14121099	Assorted	\$36.00
14121017	Gold	\$36.00
14121008	Silver	\$36.00

Pull Bows

Minimum: 100 per size, per colour.

CODE	SIZE	PRICE/EACH			
		STANDARD COLOURS		METALLIC COLOURS	
		100+	1000+	100+	1000+
132000 __	Petite 2" Bows	\$0.199	\$0.177	\$0.315	\$0.283
134000 __	Std. 4" Bows	\$0.325	\$0.294	\$0.335	\$0.483



Paper Roll/Ream Dispenser and Tape

CODE	DESCRIPTION	PRICE
09850124	Paper Roll/Ream Roll dispenser - 24" rack	\$67.42 each
09725000	Transparent Tape 1/2" x 66 m	\$33.00/box of 12 Min. order: 1 box



Ribbon Shredder

CODE: 09878600
PRICE: \$6.99 each



Curling Ribbon Roll Dispenser

CODE: 09850100
PRICE: \$136.35 each



Holds 12 Rolls

Cellophane (1.0mil)

CODE	DESCRIPTION	SIZE	PRICE/ROLL
16400506	Clear Cellophane	40" x 100'	\$12.00
16300506	Clear Cellophane	40" x 300'	\$27.50

Printed Satin and Grosgrain Ribbon

See chart to the right for Ribbon Colours.

WIDTH	PRICE/EA	Single Face Satin	Grosgrain
3/8" x 100 yd roll	\$51.00	14150002	14020000
5/8" x 100 yd roll	\$54.00	14150003	14020001
7/8" x 100 yd roll	\$65.00	14150005	14020002
1-1/2" x 50 yd roll	\$79.00	14150015	14020003

5 roll minimum per colour.

Foil Print Colours

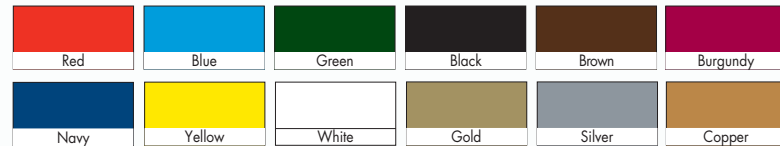

FOIL PRINT
Included in price of ribbon



Single Face Satin Ribbon with Foil Print



Grosgrain Ribbon with Foil Print
Ribbon texture not conducive to fine print.

Unprinted Satin and Grosgrain Ribbon

See chart to the right for ribbon colours.

Single Face Satin

WIDTH	CODE	PRICE/EA
3/8" x 100 yd roll	14031 ___	\$19.00
5/8" x 100 yd roll	14032 ___	\$19.95
7/8" x 100 yd roll	14033 ___	\$34.00
1-1/2" x 50 yd roll	14034 ___	\$19.95

1 roll minimum.

Grosgrain

WIDTH	CODE	PRICE/EA
3/8" x 100 yd roll	14160 ___	\$19.00
5/8" x 100 yd roll	14161 ___	\$19.95
7/8" x 100 yd roll	14162 ___	\$34.00
1-1/2" x 50 yd roll	14170 ___	\$19.95



	3/8"		5/8"		7/8"		1-1/2"		
	Single Face Satin	Grosgrain	Single Face Satin	Grosgrain	Single Face Satin	Grosgrain	Single Face Satin	Grosgrain	Colour # and Name
004 - Wheat									
007 - Shell Grey									
012 - Silver									
015 - Grey									
022 - Pewter									
028 - Antique White									
029 - White									
030 - Black									
115 - Powder Pink									
117 - Light Pink									
144 - New Nora									
150 - Pink									
151 - New Bright Pink									
156 - Hot Pink									
175 - Shocking Pink									
176 - New Shocking Pink									
186 - New Azalea									
187 - Azalea									
205 - Coral Ice									
210 - Coral Rose									
241 - Living Coral									
250 - Red									
252 - Hot Red									
255 - New Neon Pink									
260 - Scarlet									
262 - Marsala									
274 - New Maroon									
275 - Wine									
277 - Burgundy									
285 - Plum									
305 - Light Blue									
312 - Blue									
314 - New Aqua									
315 - Navajo Turquoise									
316 - Diamond									
320 - New Mystic Blue									
327 - Aegean									
328 - Island Blue									
329 - Cobalt									
330 - Tranquil Blue									
333 - Blue Bird									
340 - Turquoise									
341 - Sapphire									
343 - Tornado Blue									
346 - New Jade									
350 - Royal									
352 - Electric Blue									
353 - Century Blue									
357 - Dark Royal									
365 - Light Navy									
370 - Navy									
374 - Deep Teal									
412 - Purple Haze									
427 - Purple Wine									

	3/8"		5/8"		7/8"		1-1/2"		
	Single Face Satin	Grosgrain	Single Face Satin	Grosgrain	Single Face Satin	Grosgrain	Single Face Satin	Grosgrain	Colour # and Name
430 - Light Orchid									
431 - Wild Berry									
446 - Iris Blue									
450 - Orchid									
455 - Violet									
458 - Wisteria									
462 - Royal Orchid									
464 - Delphinium									
465 - Purple									
470 - Regal Purple									
473 - Amethyst									
476 - Grappa									
505 - New Neon Yellow									
511 - New Neon Orange									
516 - Lucite									
524 - Lime Juice									
525 - Pistachio									
528 - Lemon Grass									
530 - Mint									
533 - Jungle Green									
545 - New Neon Lime									
547 - New Chartreuse									
548 - Kiwi									
550 - Apple Green									
558 - Leaf									
567 - Spring Moss									
570 - Moss									
580 - Emerald									
586 - New Neon Green									
587 - Forest Green									
617 - Baby Maize									
640 - Lemon									
645 - Daffodil									
650 - Maize									
660 - Yellow Gold									
675 - Gold									
690 - Old Gold									
722 - Burnt Sienna									
725 - New Apricot									
743 - Ginger									
739 - Adobe									
750 - Torrid Orange									
761 - Autumn Orange									
780 - Rust									
789 - Sherry									
790 - Currant									
810 - Ivory									
815 - Cream									
825 - Natural									
835 - Tan									
841 - Khaki									
850 - Brown									
866 - Coffee									
871 - Milk Chocolate									

While we strive for accuracy in our catalogue, actual product may be slightly different than pictured.

Simply Sheer Asiana Ribbon



Monofilament-Edge

CODE	SIZE	PRICE/ROLL
149435 __	7/8" x 100 yards	\$12.00
149436 __	1 1/2" x 100 yards	\$13.50

• minimum order: one roll



Raised Ink Printing

See chart below for ribbon colours.

Pick your own colours for raised print - NO PLATE CHARGE

WIDTH	PRICE EACH	Single Face Satin CODE	Grosgrain CODE	Sheer CODE
5/8" x 100 yd roll	\$48.00	14140039	14150042	14140045
7/8" x 100 yd roll	\$51.00	14140040	14150043	14140046
1-1/2" x 50 yd roll	\$90.00	14140041	14150044	14140047

40 roll minimum for all printed ribbon.

Contessa Ribbon



Wire-Edge Single Face Satin

CODE	SIZE	PRICE/ROLL
14163 ___	1 1/2" x 25 yards	\$15.30
*14164 ___	2 1/4" x 25 yards	\$22.95

• minimum order: one roll



* 2-1/4" is only available in 029-White, 260-Scarlet, 643-Buttercream and Ivory (810).

Encore Ribbon



Wire-Edge

CODE	SIZE	PRICE/ROLL
141650 __	5/8" x 25 yards	\$6.60
141660 __	1 1/2" x 25 yards	\$13.30
141670 __	2 1/2" x 25 yards	\$19.90

• minimum order: one roll



* not available in 5/8"
† not available in 2 1/2"

Garbo Ribbon



CODE	SIZE	PRICE/ROLL
14168 ___	5/8" x 100 yards	\$50.50
14169 ___	1 1/2" x 50 yards	\$39.00

• minimum order: one roll



* not available in 5/8"
† not available in 1 1/2"

Sheer Ribbon Colours

All colors are available in all sizes. See page 119 for single face satin and grosgrain colour availability.



Single Face Satin Ribbon with Raised Print



Sheer Ribbon with Raised Print



Grosgrain Ribbon with Raised Print

Please allow 2 - 3 weeks for printed items from approved art.

IN STOCK

IN STOCK

Please allow 2 - 3 weeks for printed items from approved art.



FOIL PRINT
Included in the price.
Please allow 2-3 weeks for printing.

Customized Seals-Foil Printed

CODE	SIZE	One colour foil print/each		Two colour/each		Acetate 1 colour/each		Acetate 2 colour/each	
		2000+	5000+	2000+	5000+	2000+	5000+	2000+	5000+
25	A	\$0.1050	\$0.0950	\$0.1460	\$0.1150	\$0.1660	\$0.1290	\$0.1910	\$0.1480
	B	\$0.1150	\$0.1050	\$0.1560	\$0.1210	\$0.1990	\$0.1560	\$0.2290	\$0.1830
	C	\$0.1350	\$0.1260	\$0.1670	\$0.1390	\$0.2380	\$0.1830	\$0.2680	\$0.2180
	D	\$0.1580	\$0.1360	\$0.1780	\$0.1480	\$0.2940	\$0.2350	\$0.3170	\$0.2540

4 digit label code 2 digit label colour

\$65 plates **\$95 plates** **\$65 plates** **\$95 plates**

Label Colours Available:

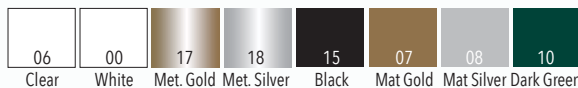

See foil chart on inside back cover of catalogue for available print colours.

Pre-printed Labels

CODE	SIZE	CASE	PRICE/EACH	
			1000+	5000+
25401007S	5/8 x 3/8"	1000	\$0.1050	\$0.0950
25401407S	5/8 x 3/8"	1000	\$0.1050	\$0.0950
25406208S	5/8 x 3/8"	1000	\$0.1050	\$0.0950
25401007V	3/4" oval	1000	\$0.1050	\$0.0950
25401407V	3/4" oval	1000	\$0.1050	\$0.0950
25406008S	3/4" oval	1000	\$0.1050	\$0.0950

1000/box minimum order - 1 box of 1000.

For a no-print solution, order our in stock Embossed Seals

Embossed Seals

500/box min. order - 1 box.

CODE	SIZE	PRICE/EA
Gold 08701207	1.5" dia.	\$0.0400
Silver 08701208	1.5" dia.	\$0.0400

ACTUAL EMBOSSED PATTERN 1.5" DIA.

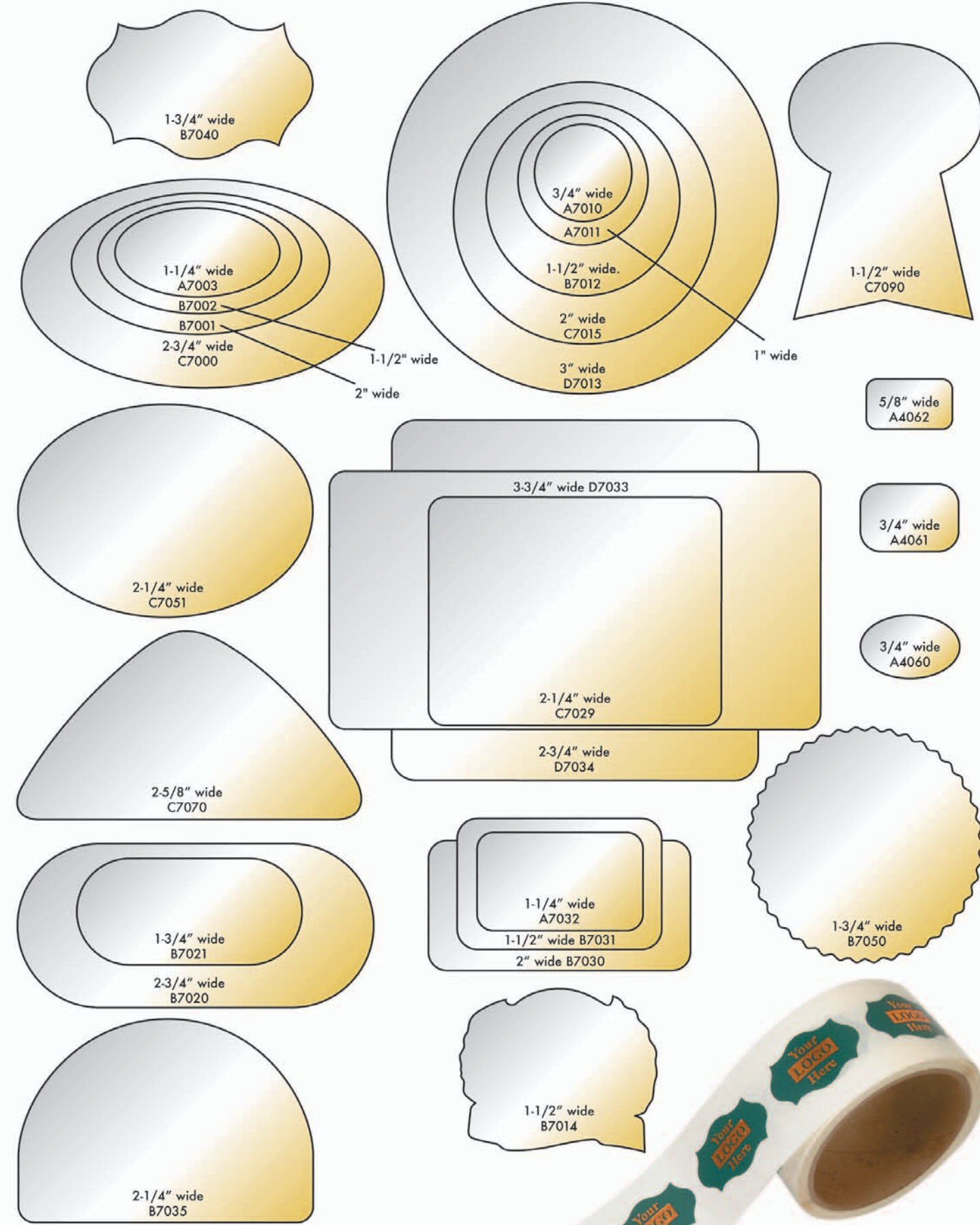

Please allow 4 - 6 weeks for printing from approved art. NO PLATE CHAGE!

CREATE YOUR OWN LOOK

CREATE YOUR OWN LOOK

Please allow 4 - 6 weeks for printing from approved art. NO PLATE CHAGE!

* Artwork charges will apply.
* Set-up charge \$30.00

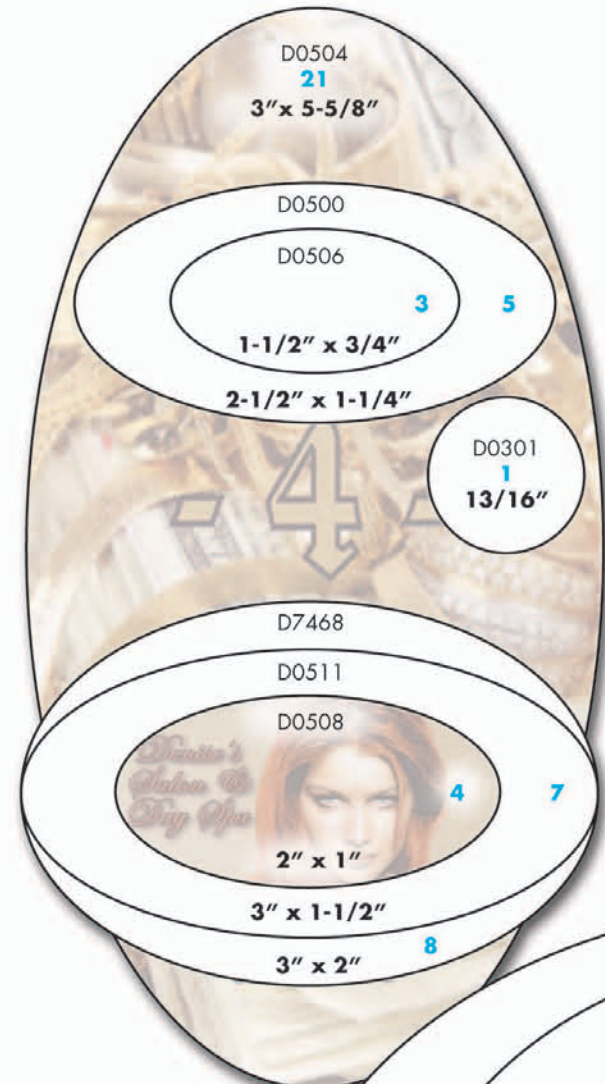

ALL PRICES ARE PER EACH

Group	1000	2000	3000	5000	10000
1	\$0.2288	\$0.1188	\$0.0814	\$0.0594	\$0.0415
2	\$0.2310	\$0.1210	\$0.0836	\$0.0616	\$0.0476
3	\$0.2332	\$0.1232	\$0.0858	\$0.0638	\$0.0547
4	\$0.2354	\$0.1254	\$0.0902	\$0.0682	\$0.0610
5	\$0.2970	\$0.1804	\$0.1298	\$0.0946	\$0.0668
6	\$0.3630	\$0.2354	\$0.1694	\$0.1188	\$0.0738
7	\$0.4202	\$0.2948	\$0.2090	\$0.1210	\$0.0800
8	\$0.4356	\$0.2990	\$0.2112	\$0.1320	\$0.0871
9	\$0.4510	\$0.3058	\$0.2134	\$0.1474	\$0.0953
10	\$0.4686	\$0.3102	\$0.2178	\$0.1496	\$0.1014
11	\$0.4840	\$0.3146	\$0.2222	\$0.1518	\$0.1063
13	\$0.5016	\$0.3256	\$0.2288	\$0.1606	\$0.1195
16	\$0.5302	\$0.3410	\$0.2442	\$0.1716	\$0.1388
17	\$0.5390	\$0.3542	\$0.2530	\$0.1782	\$0.1459
19	\$0.5610	\$0.3850	\$0.2750	\$0.1914	\$0.1591
21	\$0.5830	\$0.4026	\$0.2948	\$0.2046	\$0.1723
22	\$0.5962	\$0.4070	\$0.3036	\$0.2112	\$0.1784
24	\$0.6182	\$0.4180	\$0.3190	\$0.2222	\$0.1916
27	\$0.6490	\$0.4422	\$0.3476	\$0.2662	\$0.2108
29	\$0.6710	\$0.4554	\$0.3652	\$0.2948	\$0.2240
30	\$0.6842	\$0.4642	\$0.3784	\$0.3102	\$0.2311

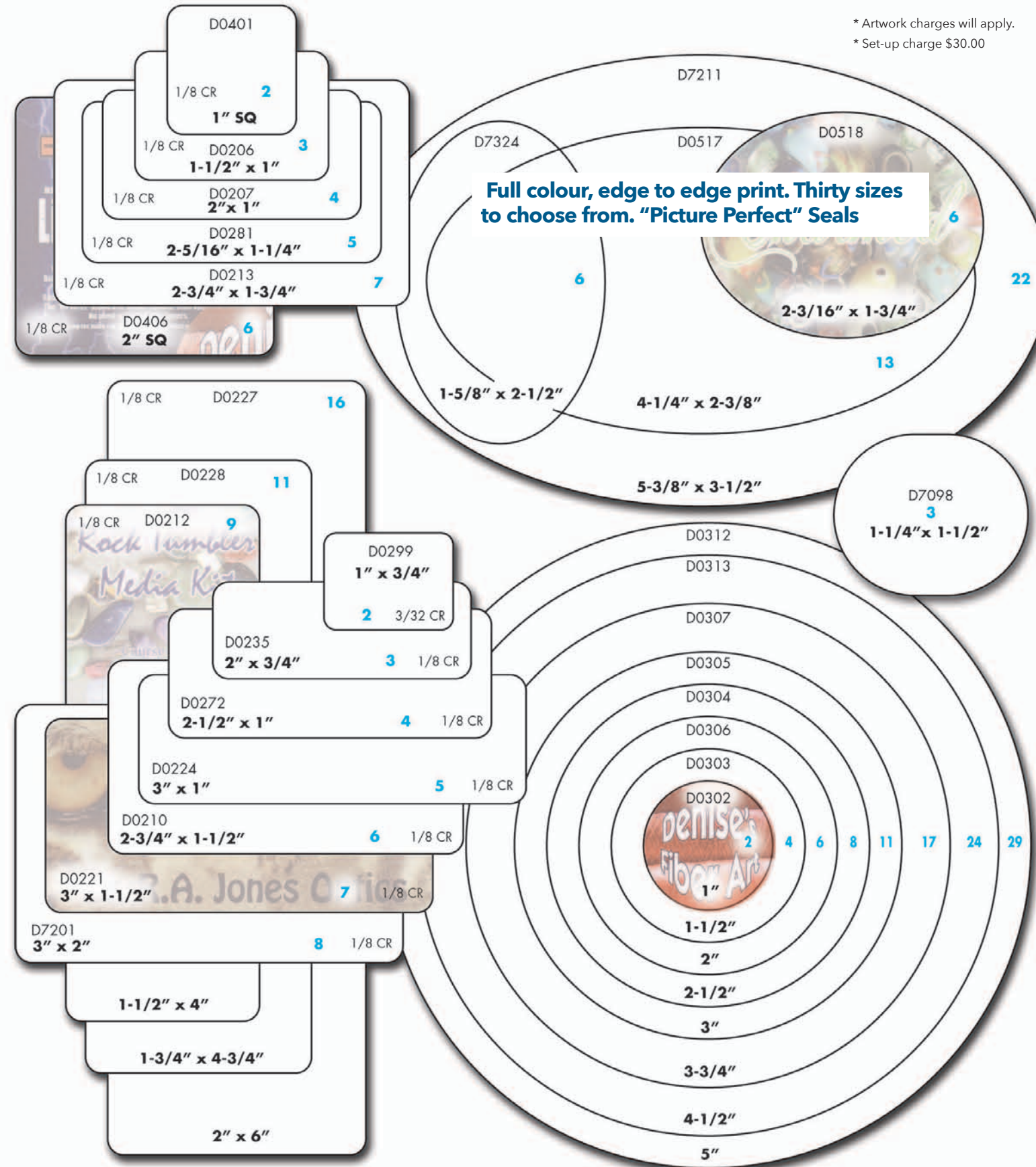







Full colour, edge to edge print. Thirty sizes to choose from. "Picture Perfect" Seals

PRINTING INFORMATION

Have your name and logo printed... it's easy!

1. Select your box or bag style, colour and size.

2. Choose the printing method you wish to use.

-  A. **FOIL PRINTING:** Foil is applied to the bag or box using a combination of heat and pressure on a magnesium print plate to create an elegant appearance. Choice of Metallic or Matte foils. Cost of Foil Printing Print plate per size and colour - \$70.00 (maximum 30 square inches)
-  B. **PAD PRINTING:** Ink is applied to smooth surfaces allowing us to print your logo in places never before possible. Cost of Pad Print plate per size and colour - \$80.00 (maximum 3.75 square inches)
-  C. **INK IMPRINTING:** Ink is applied to the box or bag using a rubber printing plate. This method is ideal for larger coverage imprints and is economically priced. Cost of Ink Printing Plate per size per colour starting at \$110.00. (maximum 25 square inches)
-  D. **SILK SCREEN:** Die fast ink is applied to Fabric Style Bags through a screen. The process allows the ink to permeate into the fabric dimples for optimal coverage. Screen charge of \$65.00 applies with each order.
-  E. **FULL COLOUR DIGITAL PRINTING:** Utilizing the latest 4-color process technology, we now offer full colour digital printed graphics on fabric and nylon bags using a heat press process. This full colour digital printing creates a transfer that allows for vibrant images on both lights and darks. Pricing is the same regardless of the amount of colours used in a design. Have your full colour image applied to your bags for just \$0.90 per bag (minimum 300 bags)
-  F. **DEBOSSING:** Using a metal plate die, debossing produces an image that's pressed into the material and indented. No colour is involved. Cost of metal plate starts at \$70.00 (maximum 70 square inches.)

3. Choose the Imprint Colour

When Foil Printing, select from 34 foil colours in 3 different finishes: Metallic (High Sheen or Matte), Flat, or Pearlized. For ink printing select from our 8 Standard colours for in stock items, or ask about Pantone Matching for Special Order items such as Simply Bags and Fabric Style Bags.

4. Send us your artwork.

If you are a new print customer, send us your artwork by e-mail or on computer disk. Artwork must be high resolution (300 dpi) and pre-sized to scale. Please contact our customer service or graphics department for acceptable file formats. 'Camera Ready' artwork is also accepted; photocopies and facsimiles are NOT acceptable as camera ready art.

If you don't have artwork or your artwork needs adjustments, we have a talented design team who can assist you. Contact one of our sales representatives or email us your ideas today. For pricing, see the artwork charges section.

Acceptable Artwork Formats

- Vector files (preferred): Adobe Illustrator with .ai, .eps, or .pdf file extension
- Raster files: (ie. PDF, PSD, TIF, or JPEG) Higher Resolution at 300dpi or more. Please note: ALL raster formats will be subject to additional art charges as in most cases it will have to be converted to a vector to meet our requirements.
- Please include fonts (.ttf) or convert fonts to outlines when sending ANY Illustrator file.

The following formats are NOT acceptable

- Publisher (.pub) • CorelDraw (.cdr) • small GIF or BMP internet images
- Any Word or spreadsheet documents - '.docx', '.xls', '.wpd', '.od'

If unsure about any format including "what is a vector" please send all inquiries to your inside Customer Service & Cc: graphics@gunthermele.com

OTHER PRINTING COSTS

Artwork Charges: As mentioned above, we have a talented creative team that can work with you to design, create, manipulate or re-size your store logo or name. Artwork service is charged at a rate of \$70.00/hour.

Set-up Charges: Every print job requires a machine to be set-up, and a charge of \$30.00 will be applied to every printed order. Please note: multiple print sizes of the same logo require multiple set-ups.

Plate Charges: Plate charges apply one-time only. Each time you require a 'new' print design (i.e. Logo change, Print Size Adjustment etc.) a new plate must be created. Once the plate is made, we will hold it for you in our warehouse and it will be available for all future printing requirements. Plate charges range in cost from \$70.00 for a Foil Printing plate to \$110+ for an Ink Printing Plate. (maximum 25 square inches)

FOIL STAMPING COLOURS

Metallic Options

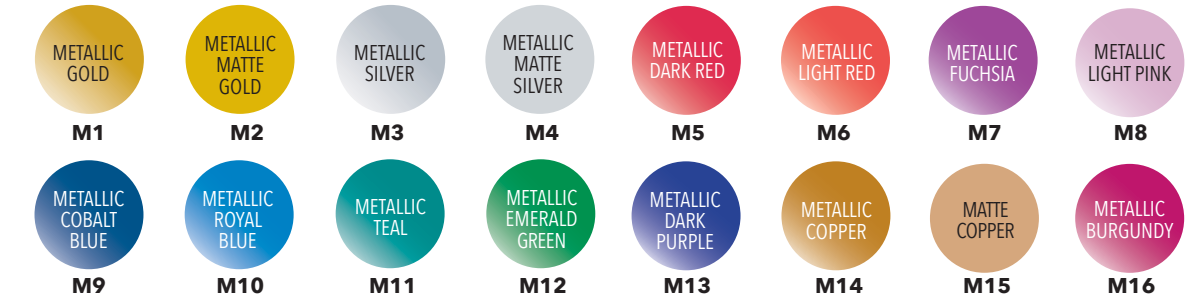

Metallic options feature a high sheen finish unless otherwise indicated as matte finish.

Flat Options



Pearlized Options Printable only on white.



Satine Foil Colours



INK IMPRINTING COLOURS



PAD IMPRINTING COLOURS

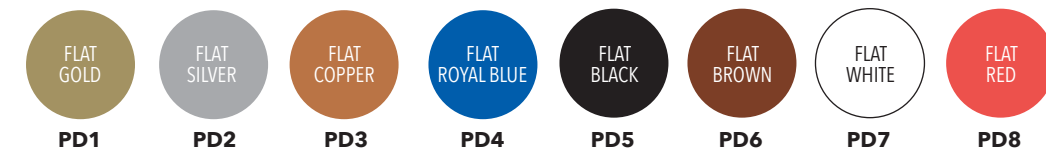

Colours shown are representations only and may not reflect true production colours.

GUNTHER MELE 1857

CARRY YOUR BRAND FORWARD

TO PLACE AN ORDER

Call Customer Service: 519.756.4330
Toll Free: 1.888.486.8437
Order on line: gunthermele.com
Direct Fax: 519.756.4335



FOR EASY PAYMENT OPTIONS

- Order online and pay with your credit card at gunthermele.com.
- We accept all major credit cards.
- Payments may also be made via on line, banking by selecting "Gunther Mele" as a payee.

Sign up for paperless billing. See our website for more information.

Sales Representatives:

British Columbia

DAVE McQUILLIN
Cell: 778.228.1554
Tel: 1.604.859.0747
Fax: 1.604.859.0716
Email: dmcquillin@gunthermele.com

Alberta

PAUL EMERY
Tel: 519.805.4330
Fax: 519.756.4335
pemery@gunthermele.com

Manitoba/Saskatchewan/Thunder Bay

TIM BENNER
Tel: 204.792.3062
Fax: 204.757.9484
Email: tbenner@gunthermele.com

Northern Ontario

IAN MacDONALD
Cell: 705.345.0324
Fax: 705.689.9932
Email: imacdonald@gunthermele.com

Southwestern Ontario

LAUREL OWENS
Cell: 519.495.2699
Fax: 519.269.9812
Email: lowens@gunthermele.com

Hamilton/Niagara/Burlington/ Oakville/Milton

CHERYL WIACEK
Cell: 519.751.5313
Fax: 519.756.4335
Email: cwiacek@gunthermele.com

Greater Toronto Area

JACKIE CHONG
Cell: 416.721.8385
Fax: 519.756.4335
Email: jchong@gunthermele.com

Toronto

JIM TERESCHUK
Cell: 416.882.3346
Fax: 519.256.1486
Email: jjimtereschuk@sympatico.ca

Eastern Ontario

PAUL EMERY
Tel: 519.805.4330
Fax: 519.756.4335
pemery@gunthermele.com

Montreal/Western Quebec

MARIE TOUTONGI
Cell: 514.816.7683
Fax: 514.485.7684
Email: mtoutongi.pkg@videotron.ca

Rural Quebec & Gaspe

MICHEL LATERREUR
Cell: 819.479.5653
Tel: 819.474.1110
Fax: 819.474.2951
Email: mlaterre@cgocable.ca

Maritimes

MARK AMYOT
Tel: 902.893.1209
Fax: 800.494.5447
Email: forefront@ns.sympatico.ca

Newfoundland/Labrador

PAUL EMERY
Tel: 519.805.4330
Fax: 519.756.4335
pemery@gunthermele.com

TERMS AND CONDITIONS:

- Minimum order \$250.00.
- F.O.B point: Brantford, Ontario Canada.
- Net 30 days O.A.C.
- New account payment terms: Visa or MasterCard 50% deposit with order, balance due upon shipping.
- Defective merchandise will be accepted back for credit only if claimed within 15 days of receipt of shipment. Authorization number must be obtained by contacting our customer service department 1.888.486.8437.
- In-transit damages and shortages must be claimed with the freight carrier at time of delivery.
- All lead times are estimates only (from receipt of approved artwork and credit) and are not guaranteed.
- Plate charges where applicable are:
Foil Print Dies: \$70.00 per size (maximum 30 square inches)
Pad Dies: \$80.00 per size (maximum 3.75 square inches)
Ink Plates \$110.00 (maximum 25 square inches)
- **While we strive for accuracy in our catalogue, actual product may be slightly different than pictured.**
- Prices subject to change without notice.

GUNTHER MELE LTD., 30 Craig Street, Brantford, ON N3R 7J1 Tel: 519.756.4330 Fax: 519.756.4335 Email: info@gunthermele.com

GUNTHERMELE.COM