

JEWELLERY PACKAGING GUIDE – WITH GML PRICING
2023 • VOLUME 165



MISSION GREEN

OUR VISION

“Helping our customers tell their unique brand story while providing a customer experience like no other.”

– Darrell King, President

Welcome to our new packaging guide – our 165th version since our founding in 1857.

We have some exciting developments in the following pages. Most of the changes we have ushered in this year are centered around a more sustainable approach to our business with an emphasis on the materials we use and the reusability of our products. We have begun to view all of our products through this new lens of eco-minded sustainability. We call this our **“Mission Green”**.

Mission Green drives us to use materials that are either from recycled or sustainable sources. It also focuses us on a vastly overlooked practice in sustainability: reusability.



RECYCLED

There are two important terms that classify the source of recycled content. These are: post-consumer waste and post-industrial waste.

Post-consumer waste (PCW). Wherever possible, we are using paper and now plastics that are derived, at least partially if not fully, from municipal recycling programs and this term post-consumer implies that it has been recovered after consumer use.

Post-industrial waste (PIW). Another key source of recycled material. In this instance, scrap material is diverted from the landfill and recycled into new material to be used in production.

Product Examples include: our brand new, Canadian made paper twist shoppers made from paper that is derived from 96% post-consumer waste. Our new “resuede” is a luxurious recycled material that feels like plush suede but is produced using recycled materials to create a luxury look and feel. We feature our resuede material in our Drawer Series box (page 39) and our Eco Series of hinged boxes (page 27)

SUSTAINABLE

FSC – Forestry Stewardship Council. In short, this governing body oversees wood and pulp (paper) products derived from responsibly managed forests. This global governing body is an intricate certification process that verifies paper and its sources. In the instances where paper needs to come from new pulp source, we are choosing to use papers that carry the widely recognized FSC designation.

REUSABLE

Jewellery packaging has an inherent keepsake quality. Most people will collect jewellery boxes for storage and sentimental value. We have also been studying consumer behavior and there is demand for an after use of jewellery packaging. Our active lifestyles and thirst for travel dictates the need to store and protect jewelry when it is not being worn. With that, we have introduced our new Nano™ collection of luxurious and practical travel pouches that not only present the jewellery exquisitely but also doubles as ongoing storage and protection for our society who is always on the go.

In nearly every category we have exciting new products that meet our Mission Green criteria. These are just the first steps of our journey toward more sustainable and eco-conscious packaging solutions and we hope you'll join us on this important journey.

TRENDING

ECO CHIC



Signature Velvet Series

Plush black velvet hinged boxes accented with suede pads and bengaline trim detail
See page 17



EcoBox Hinged

50% recycled material plastic shell
resuede interior
See page 27



Drawer Box

100% recyclable paper board with
resuede pads and pulls
See page 39



Deco Box

Recycled paperboard
See page 41



CYOL 6 Easy Pieces Hinged Packaging

with coordinating eurototes
See page 28



All Paper Shopper

100% recyclable / 40% post
consumer waste
See page 79



RPET REUSABLES

Mission Green - sustainable 80% woven
recycled RPET laminated tote
See page 91



Paper Twist

Mission Green - 100% recyclable
See page 85

CYOL

Made to Order Jewellery Display



Tell your brand story
Create your unique identity

Elevate the
shopping experience

Drive more sales

**Complimentary
Display Design**

Financing Programs Available

*Complete set of renderings available with payment of deposit.
Deposits will be deducted from invoice at time of billing.



IN STOCK

Jewellery Display



Platforms and Risers

Ring Showcase

Pendant & Earring Stands

Neck Forms & Bracelet Stands

Trays, Counter Pads,
Chain Ramps

Open Stock and Prepacks
Available

**Save 25% when you buy
\$500 or more!**



PROPOSAL

Ring Presentation



Ring Stash

The solution to bulky engagement ring boxes.

- Discreet compact size
- Flexible ring clip firmly holds the ring in place
- Magnetic closure
- Light weight and durable
- Black sleeve packer
- Printing options available
- U.S. Patent #9375066

68021015L
2.32" x 2.44" x .55
\$22.94/ea. 12/case

Minimum order 12.
Estimated lead time: 2 - 3 weeks for printed items from approved art.

You've sold the perfect ring.
They've planned the perfect moment.

Help them keep it a secret.

FOIL / PAD PRINT
F: inside liner / PP: top lid only
12+ 35¢ each
144+ 32¢ each
504+ 26¢ each

PROPOSAL

Ring Presentation



Proposal Ring Hinged Box

- Single ring box with matching ribbon pull accent and ring clip
- Brushed ivory linea interior
- White sleeve packer
- Minimum case pack 12

36220 _ _ _ _
2.36" x 2.36" x .94"
\$4.01 each (12+)
\$3.50 each (144+)

Estimated lead time: 2 - 3 weeks for printed items from approved art.

FOIL / PAD PRINT
F: inside top liner
PP: inside top liner and top lid
12+ 35¢ each
144+ 32¢ each
504+ 26¢ each

873B - Bronze



Sweetheart Box

See page 31



Nano Clutch

See page 38



All print orders subject to set-up charges. Applicable artwork, and plate charges may apply. See page 122.

All print orders subject to set-up charges. Applicable artwork, and plate charges may apply. See page 122.

TABLE OF CONTENTS

Jewellery Packaging

| | | | |
|--------------------------------------|---------|--|-----------|
| Proposal Ring Specialty Boxes | 8 - 9 | Nest Boxes | 46 - 48 |
| Hinged Packaging | 12 - 39 | Jewellery Folders | 38 and 49 |
| New Signature Series | 17 | Create Your Own Look Details | 50 - 51 |
| ECO EcoBox | 27 | Gift Card and Certificate Boxes | 52 - 53 |
| Vantage | 29 | Pouches | 54 - 55 |
| ECO Drawer Box | 39 | New Jewellery Cloths and Cleaners | 56 - 57 |
| Paperboard Jewellery Packaging | 40 - 45 | Repair Envelopes and Tags | 58 |

Jewellery Display

| | | | |
|---|---------|--|---------|
| Create Your Own Look Element and Showcase Platform Styles | 60 - 61 | New In Stock Jewellery Displays | 64 - 72 |
| Create Your Own Look Fabrics and Colour Options | 62 - 63 | | |

Jewellery Storage by Mele & Co.

| | |
|------------------------------------|----|
| Stowaway Line and Highlights | 74 |
|------------------------------------|----|

Bags

| | | | |
|--|----|---|----|
| Vantage, Eclipse and Geo Eurototes | 76 | New ECO Food Service Kraft Bags | 87 |
| Rope Handle Paper Totes | 77 | Custom Printed Poly Shopping Bags | 88 |
| Grograin Handle Eurototes | 78 | Frosted Poly | 89 |
| ECO All Paper Eurototes | 79 | Poly Merchandise Bags | 89 |
| CYOL Rope Handle | 80 | Custom Full Colour Reusable | 90 |
| 5th Avenue Eurototes | 81 | ECO RPET Reusable Bags - Recycled Bottles .. | 91 |
| Manhattan Eurototes | 82 | New Upcycle and Toronto Laminated Totes ... | 92 |
| New ECO Special Order Paper Shoppers | 83 | In Stock Reusable Fabric Shoppers | 93 |
| ECO CYOL Simply Paper Shoppers | 84 | Garment Covers | 94 |
| ECO In Stock Paper Twist Handle & Damask .. | 85 | | |
| ECO In Stock Die Cut Handle & Merchandise .. | 86 | | |

Gift Boxes and E-Commerce

| | | | |
|--------------------------------|----|--|-----|
| Malibu Magnetic Gift Box | 96 | CYOL E-Com Boxes and Mailers | 100 |
| Tuckit® Boxes | 96 | New In Stock E-Com Boxes for Gift & Apparel.. | 101 |
| White Folding Gift Boxes | 97 | In Stock E-Com Boxes for Jewellery | 101 |
| Apparel Boxes | 97 | In Stock and S/O E-Com Mailers | 102 |

Finishing Touches

| | | | |
|---|-----------|---|-----------|
| New Inspirations Gift Wrap | 104 - 105 | Printed and Unprinted Ribbon | 114 - 117 |
| Jewellers Rolls | 109 | In Stock Seals - Foil Print | 118 - 119 |
| Special Order Gift wrap | 106 - 109 | Custom Seals - Full Colour | 120 - 121 |
| Tissue Paper | 110 - 111 | Print Information & Print Colours | 122 - 123 |
| Bows, Cellophane & Dispensers ... | 112 - 113 | | |

JEWELLERY PACKAGING



CREATE YOUR OWN LOOK

JEWELLERY PACKAGING



WOOD SERIES

The possibilities are endless when you choose wooden materials. Endless and timeless, in terms of size, shape, finish and colour. High-end style, this collection features our Monterey series shape with a high gloss white finish, black "reveal" edge and black linea interior. Add a matching custom tote bag to complete the look.

IN STOCK Hinged Boxes

JEWELLERY PACKAGING



**COORDINATING
EUROTOTES**
See pages 77

Available Colours



Outer Box

150MC - Black Gloss

Outer Box

320M - Mahogany

150MCB -
OPTIONAL
BLACK INTERIOR
RING BOX ONLY

Monterey II

Wood series with modern lines and a gloss finish.

- Soft white leatherette interior
- Packaged in a 2-piece white traditional outer box

| CODE | DESCRIPTION | SIZE (inches) | PRICE/EACH | |
|-------|----------------------|----------------------|------------|---------|
| | | | 12+ | 144+ |
| 36821 | Ring (R1) | 2.375 x 2.375 x 2 | \$11.79 | \$9.63 |
| 36822 | Earring (E1) | 2.375 x 2.375 x 2 | \$11.79 | \$9.63 |
| 36843 | Utility T-pad (ET14) | 4 x 4 x 2 | \$17.80 | \$15.81 |
| 36850 | Watch (PL1) | 4.375 x 4.375 x 2.75 | \$22.86 | \$19.22 |
| 36893 | Bracelet (BL1) | 9.5 x 2.375 x 1.5 | \$26.55 | \$22.19 |
| 36813 | Necklace (N2) | 7.5 x 7.5 x 2 | \$38.22 | \$29.54 |

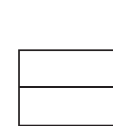

R1
SLOTTED RING PAD

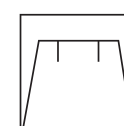

E1
DIE CUT EARRING/PENDANT PAD



ET14
T FLAP PENDANT/EARRING PAD

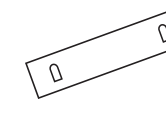

BL1
BRACELET PAD (metal clip)
GLUED PAD

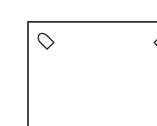

N2
NECKLACE PAD GLUED

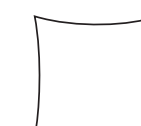

PL1
WATCH PILLOW



See page 50.



FOIL / PAD PRINT

F: inside liner and packer lid / PP: all 3 locations
12+ 35¢ each
144+ 32¢ each
504+ 26¢ each

Minimum 12 per style.
Please allow 2 - 3 weeks for printed items from approved art.

All print orders subject to set-up charges. Applicable artwork, and plate charges may apply. See page 122.

CREATE YOUR OWN LOOK

JEWELLERY PACKAGING



WHISPER SERIES

Our modern luxury box is shown here in a stylish textured gold paper called: Shuttle. Matching interior and pads create a seamless look.

IN STOCK

Hinged Boxes

JEWELLERY PACKAGING



**COORDINATING
EUROTOTE**
See page 78

Available Colours



Outer Box
559W - Carbon Black



Outer Box
009W - Moon Glow



Outer Box
289W - Palladium

Whisper

Elegant curves and round corners.

- Monochromatic metallic pinsketch linea fabric
- Packaged in a coordinating 2-piece outer box

| CODE | DESCRIPTION | SIZE (inches) | PRICE/EACH | |
|-------|----------------------|-----------------------|------------|---------|
| | | | 12+ | 144+ |
| 36821 | Ring (R1) | 2.375 x 2.375 x 2.125 | \$8.43 | \$7.36 |
| 36822 | Earring (E1) | 2.375 x 2.375 x 2.125 | \$8.43 | \$7.36 |
| 36823 | Large Ring (R1) | 3.25 x 3.25 x 2.25 | \$11.34 | \$9.81 |
| 36883 | Utility T-pad (ET14) | 3.25 x 3.25 x 2.25 | \$11.34 | \$9.81 |
| 36850 | Watch (PL1) | 4 x 4 x 2.75 | \$15.32 | \$13.34 |
| 36893 | Bracelet (BL1) | 9.25 x 2.5 x 1.75 | \$15.12 | \$13.20 |
| 36873 | Necklace (N2) | 6.5 x 8 x 1.75 | \$23.63 | \$19.41 |

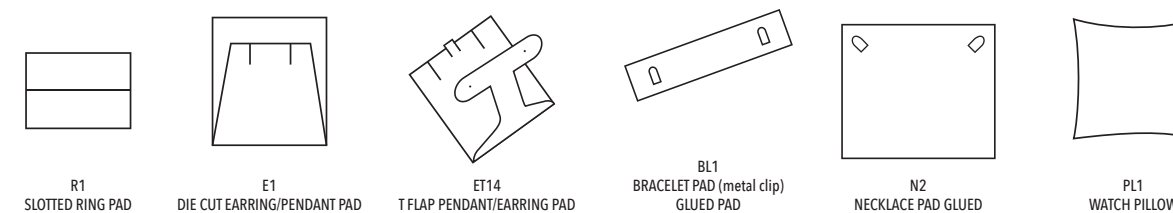

FOIL / PAD PRINT
F: inside liner and packer lid / PP: all 3 locations
12+ 35¢ each
144+ 32¢ each
504+ 26¢ each

Minimum 12 per style.
Please allow 2 - 3 weeks for printed items from approved art.

All print orders subject to set-up charges. Applicable artwork, and plate charges may apply. See page 122.

CREATE
YOUR OWN LOOK

JEWELLERY PACKAGING



VELVET SERIES

Plush velvet hinged boxes accented with suede pads and bengaline trim detail.

IN STOCK
Hinged Boxes

JEWELLERY PACKAGING



COORDINATING
EUROTOTE
See page 78

Signature Series

This modernized classic is a must have.

- Plush black velvet hinged boxes accented with suede pads and bengaline trim detail
- Packaged in a coordinating 2-piece outer box

| CODE | DESCRIPTION | SIZE (inches) | PRICE/EACH | |
|----------|----------------------|--------------------|------------|---------|
| | | | 12+ | 144+ |
| 36521151 | Ring (R1) | 1.96 x 1.96 x 1.96 | \$9.25 | \$8.15 |
| 36522151 | Pendant/Earring (E1) | 2.36 x 2.36 x 2.28 | \$11.53 | \$9.40 |
| 36583151 | Utility (PL1 or T3) | 3.93 x 3.93 x 2.36 | \$12.62 | \$11.11 |
| 69550151 | Pillow (PL1) | fits utility box | \$3.15 | \$2.78 |
| 69583151 | Triple Flip Pad (T3) | fits utility box | \$3.15 | \$2.78 |
| 36573151 | Necklace (N3) | 7 x 7 x 1.77 | \$20.39 | \$17.95 |

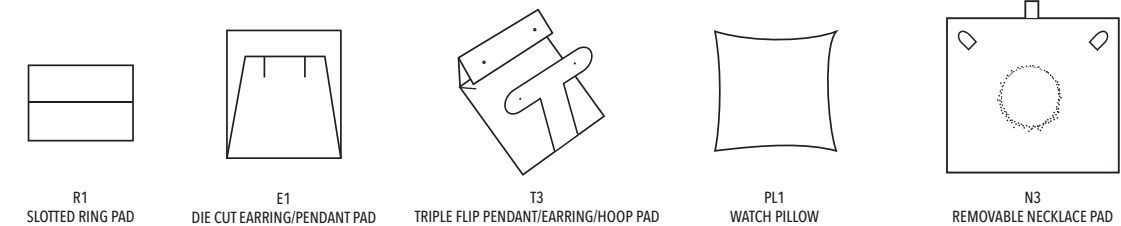

FOIL / PAD PRINT
F / PP: inside liner and packer lid
12+ 35¢ each
144+ 32¢ each
504+ 26¢ each

Minimum 12 per style.
Please allow 2 - 3 weeks for printed items from approved art.

All print orders subject to set-up charges. Applicable artwork, and plate charges may apply. See page 122.

CREATE YOUR OWN LOOK

JEWELLERY PACKAGING



ECLIPSE SERIES

This eclipse collection features an elegant champagne custom embossed covering with an ivory shimmer interior and gold printed logo on the top liner. The custom rope handle tote completes this beautiful collection.

IN STOCK Hinged Boxes

JEWELLERY PACKAGING



**COORDINATING
EUROTOTE**
See page 76

Available Colours



Outer Box

813 - Linea Blue Celestial



Outer Box

663 - Linea Aubergine



Outer Box

423 - Brown



Eclipse

Classic square corners with a distinctive crescent style front.

- Linea Aubergine and Linea Blue Celestial coverings with Ivory Shimmer satin top liners and pads. Packaged in coordinating full-depth 2-piece outer box
- Rich Brown leatherette covering with Champagne satin top liners and sueded pads. Packaged in white full-depth 2-piece outer box

| CODE | DESCRIPTION | SIZE (inches) | AUBERGINE AND BLUE PRICE/EACH | | BROWN PRICE/EACH | |
|-----------|----------------------|-------------------|----------------------------------|---------|---------------------|---------|
| | | | 12+ | 144+ | 12+ | 144+ |
| 36821 ___ | Ring (R1) | 2.5 x 2.5 x 1.75 | \$8.67 | \$7.56 | \$7.23 | \$5.75 |
| 36822 ___ | Earring/Pendant (E1) | 2.5 x 2.5 x 1.75 | \$8.67 | \$7.56 | \$7.23 | \$5.75 |
| 36883 ___ | Utility T-pad (ET14) | 3.75 x 4 x 1.75 | \$13.02 | \$11.55 | \$9.53 | \$8.15 |
| 36893 ___ | Bracelet (BL1) | 9.25 x 2.5 x 1.75 | \$16.41 | \$14.42 | \$12.15 | \$9.94 |
| 36873 ___ | Necklace (N2) | 6.5 x 8 x 1.75 | \$26.83 | \$22.11 | \$23.62 | \$19.84 |
| 36850 ___ | Watch (PL1) | 3.75 x 4.25 x 3 | \$17.56 | \$15.08 | \$12.91 | \$10.61 |

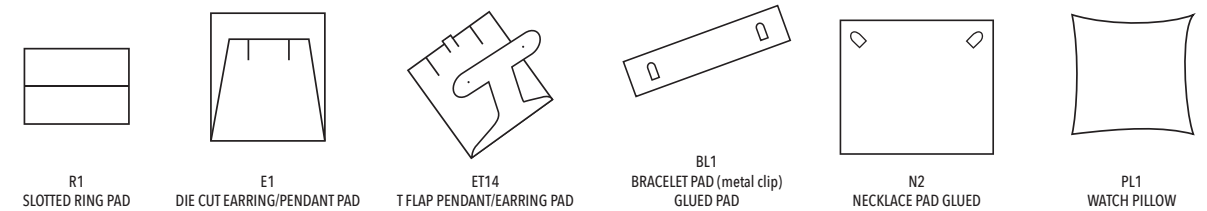

FOIL / PAD PRINT
F: inside liner and packer lid / PP: all 3 locations
12+ 35¢ each
144+ 32¢ each
504+ 26¢ each

Minimum 12 per style.
Please allow 2 - 3 weeks for printed items from approved art.

All print orders subject to set-up charges. Applicable artwork, and plate charges may apply. See page 122.

IN STOCK

Hinged Boxes

JEWELLERY PACKAGING



COORDINATING EUROTOTE
See pages 77



Available Colours



114 - Blue

674 - Green

Estate

Contemporary style with a touch of tradition.

- White velvet pads and satin top liners
- Packaged in a coordinating 2-piece outer box

| CODE | DESCRIPTION | SIZE (inches) | PRICE/EACH | |
|-----------|----------------------|----------------------|------------|---------|
| | | | 12+ | 144+ |
| 36021 --- | Ring (R1) | 2 x 2.25 x 1.875 | \$6.74 | \$5.34 |
| 36022 --- | Earring (E1) | 2 x 2.125 x 1.625 | \$6.53 | \$5.20 |
| 36084 --- | Utility T-pad (ET14) | 3.5 x 3.5 x 1.5 | \$8.45 | \$6.88 |
| 36093 --- | Bracelet (BL1) | 8.5 x 2.125 x 1 | \$14.52 | \$11.64 |
| 36073 --- | Necklace (N2) | 7.125 x 4.375 x 1.25 | \$20.63 | \$16.53 |



FOIL / PAD PRINT
F: inside liner and packer lid / PP: all 3 locations
12+ 35¢ each
144+ 32¢ each
504+ 26¢ each

Minimum 12 per style.
Please allow 2 - 3 weeks for printed items from approved art.



IN STOCK

Hinged Boxes

JEWELLERY PACKAGING



COORDINATING EUROTOTE
See page 81

OPTIONAL WHITE INTERIOR AVAILABLE
153 - White on Black

OPTIONAL BLACK INTERIOR AVAILABLE
153B - Black on Black



Outer Box

Roma

Distinctive round corner styling with sculpted sides.

- Lizard style embossed covering with leatherette interior
- Packaged in a 2-piece coordinating outer box with ¼ depth lids

| CODE | DESCRIPTION | SIZE (inches) | PRICE/EACH | |
|------------|----------------------|--------------------|------------|---------|
| | | | 12+ | 144+ |
| 36421 ---- | Ring (R1) | 2.25 x 2.25 x 1.75 | \$6.34 | \$5.14 |
| 36422 ---- | Earring (E1) | 2.25 x 2.25 x 1.75 | \$6.34 | \$5.14 |
| 36484 ---- | Utility T-pad (ET14) | 3.75 x 3.75 x 2 | \$8.38 | \$7.15 |
| 36493 ---- | Bracelet (BL1) | 9.375 x 2.25 x 1.5 | \$13.40 | \$11.49 |
| 36477 ---- | Necklace (N3) | 7.5 x 7.5 x 2.125 | \$23.07 | \$19.42 |



FOIL / PAD PRINT
F: inside liner and packer lid / PP: all 3 locations
12+ 35¢ each
144+ 32¢ each
504+ 26¢ each

Minimum 12 per style.
Please allow 2 - 3 weeks for printed items from approved art.



All print orders subject to set-up charges. Applicable artwork, and plate charges may apply. See page 122.

All print orders subject to set-up charges. Applicable artwork, and plate charges may apply. See page 122.

CREATE YOUR OWN LOOK

JEWELLERY PACKAGING



GEO SERIES

A series completely unique with added top stitching to the covering and upgrading the fabric to a luxurious grey leatherette. This Geo collection features a debossed logo on the top of the lid. Matching dark interior pads create a seamless look to showcase fine pieces. Packaged in two-tone 3/4 depth outer box with a silver embossed print. This collection is completed with coordinating custom rope handle totes.

IN STOCK Hinged Boxes

E-Commerce Jewellery Boxes

Deliver the 'in-store' experience to your customer's door
See page 101 for more information



Hinged Boxes

Available Colours



873B - Bronze



563P - Purple



153B - Black



083 - Luxe Silver*



50% Recycled Shell and FSC Paper Used



COORDINATING
EUROTOTE
See page 76

415B - Black Packer with Ivory Pouch
456P - Purple Packer with Ivory Pouch
427T - Bronze Packer with Ivory Pouch

Geo

Modern texture in a choice of 4 colour options.

- Ivory brushed leatherette pads and satin top liners
- Packaged in a coordinating 3/4 depth 2-piece outer box

| CODE | DESCRIPTION | SIZE (inches) | PRICE/EACH | |
|-----------|--|-----------------------|------------|---------|
| | | | 12+ | 144+ |
| 36221 | Ring/Earring (R1/E8) | 2.375 x 2.375 x 2.375 | \$5.76 | \$4.72 |
| 36283 | T-pad Pendant (ET14) | 3.5 x 4.5 x 1.5 | \$6.85 | \$5.92 |
| 36293 | Bracelet (BL1) | 9 x 2.375 x 1.5 | \$9.00 | \$7.65 |
| 36273 | Necklace (N2) | 7 x 7 x 1.5 | \$14.37 | \$12.69 |
| 36220 | Proposal Box* (R2) | 2.36 x 2.36 x .94 | \$4.01 | \$3.50 |
| 36224 | Lighted Ring/Earring* (R1) | 2.36 x 2.36 x 2.36 | \$14.47 | \$12.69 |
| 09030 | Pouch with Box* | 3 x 4 | \$2.77 | \$2.35 |
| 69221100G | Earring Pad to fit Ring/Earring box (E8) | | \$0.98 | |

* not available in Luxe Silver

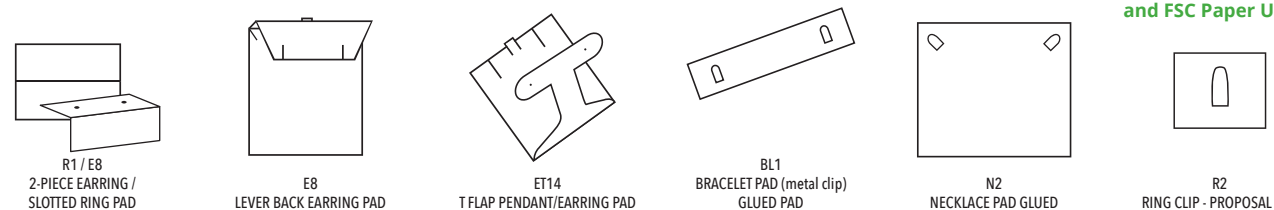

FOIL / PAD PRINT

F: inside liner and packer lid / PP: all 3 locations
12+ 35¢ each
144+ 32¢ each
504+ 26¢ each

Minimum 12 per style.
Please allow 2 - 3 weeks for printed items from approved art.

All print orders subject to set-up charges. Applicable artwork, and plate charges may apply. See page 122.

JEWELLERY PACKAGING

SPECIAL ORDER

Geo Series Boxes and Bags

JEWELLERY PACKAGING



Available in 16 colours in a selection of 4 luxurious textured papers.



Shown in Celestial Blue

Shown in Moss

Shown in Brick

Contact your representative for assistance selecting your texture and colour.

SPECIAL ORDER

Geo Series Boxes and Bags

JEWELLERY PACKAGING

16 Colour Options Available



4 Texture Paper Options Available



Geo Hinged Packaging

- Ivory brushed leatherette pads and satin top liners
- Packaged in a coordinating ¾ depth 2-piece outer box

| DESCRIPTION | SIZE (inches) | PRICE/EACH |
|---------------|-----------------------|------------|
| Ring/Earring | 2.375 x 2.375 x 2.375 | \$6.84 |
| T-pad Pendant | 3.5 x 4.5 x 1.5 | \$7.94 |
| Bracelet | 9 x 2.375 x 1.5 | \$9.03 |
| Necklace | 7 x 7 x 1.5 | \$13.69 |
| Proposal Box | 2.36 x 2.36 x .94 | \$5.12 |

FOIL PRINT - INCLUDED IN PRICE
Inside Top Liner
Packer Lid

Boxes: Minimum 1500 assorted! (min 100 per box)
Bags: Minimum 1000 each size with purchase of 1500 boxes.
Estimated lead time: 12 - 14 weeks for printed items from approved art.

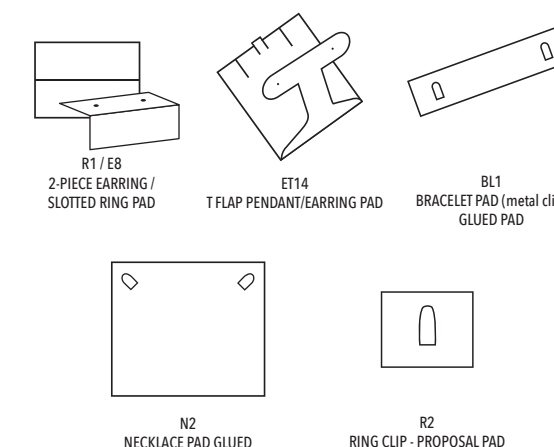

Geo Eurototes

- 110 gsm uncoated paper with 8mm rope handles
- Foil printed two sides

| SIZE (inches) | PRICE/EACH |
|--------------------|------------|
| 6 x 3.5 x 6 x 3.5 | \$1.97 |
| 9 x 3.5 x 7 x 3.5 | \$2.24 |
| 10.5 x 5 x 8.5 x 5 | \$2.94 |

FOIL PRINT
PRINTING INCLUDED IN PRICE

Bags Only: Minimum 3000 each size.
Estimated lead time: 12 - 14 weeks for printed items from approved art.

Our Top Selling Collection Just Got Even Better!

Printing included for any of the items in this program.

Choice of Matte or Metallic Foil Print:
Gold, Silver, Copper or Black.

All print orders subject to set-up charges. Applicable artwork, and plate charges may apply. See page 122.

IN STOCK

Hinged Boxes

JEWELLERY PACKAGING



**COORDINATING
EUROTOTE**
See page 77

Palladium Inlay

Stylish contemporary series.

- Palladium grey brushed exterior
- Cream pads and top liner with matching exterior edge
- Packaged in a coordinating 2-piece outer box

| CODE | DESCRIPTION | SIZE (inches) | PRICE/EACH | |
|-----------|----------------------|--------------------|------------|---------|
| | | | 12+ | 144+ |
| 36221283P | Ring (R1) | 2.25 x 2 x 1.75 | \$6.13 | \$5.04 |
| 36222283P | Earring (E1) | 2.25 x 2 x 1.75 | \$6.13 | \$5.04 |
| 36283283P | Utility T-pad (ET14) | 3.18 x 4.17 x 1.41 | \$8.65 | \$7.35 |
| 36293283P | Bracelet (BL1) | 8.6 x 2.16 x 1 | \$9.94 | \$8.33 |
| 36273283P | Necklace (N2) | 6.25 x 4.4 x 1.41 | \$11.88 | \$10.01 |



FOIL / PAD PRINT
F: inside liner and packer lid / PP: all 3 locations
12+ 35¢ each
144+ 32¢ each
504+ 26¢ each

Minimum 12 per style.
Please allow 2 - 3 weeks for printed items from approved art.



See page 50.

IN STOCK

Hinged Boxes

JEWELLERY PACKAGING



**COORDINATING
ALL PAPER EUROTOTE**
See page 79

EcoBox

Modern look inside and out.

- Gunther Mele Mission Green product
- Made with recycled paper exterior
- Made with 50% recycled material plastic shell
- Resuede interior material (49% recycled)

| CODE | DESCRIPTION | SIZE (inches) | PRICE/EACH | |
|----------|------------------------------|--------------------|------------|---------|
| | | | 12+ | 144+ |
| 36121000 | Ring/Earring (R1) | 2 x 2 x 1.5 | \$4.69 | \$3.98 |
| 36163000 | T-Pad Pendant/Earring (ET14) | 3.75 x 3.75 x 1.33 | \$7.54 | \$6.41 |
| 36193000 | Bracelet (BL1) | 8.5 x 2 x .91 | \$6.64 | \$5.64 |
| 36173000 | Necklace (N3) | 7 x 5 x 1.10 | \$12.04 | \$10.25 |

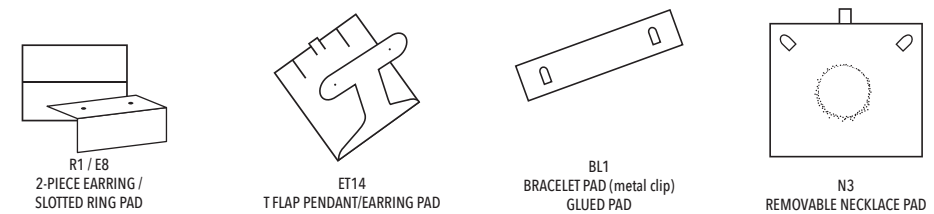

FOIL / PAD PRINT
F: inside liner / PP: top lid
12+ 35¢ each
144+ 32¢ each
504+ 26¢ each

Minimum 12 per style.
Please allow 2 - 3 weeks for printed items from approved art.



All print orders subject to set-up charges. Applicable artwork, and plate charges may apply. See page 122.

All print orders subject to set-up charges. Applicable artwork, and plate charges may apply. See page 122.

CREATE YOUR OWN LOOK

JEWELLERY PACKAGING



VANTAGE SERIES

6 pieces – 2 boxes + 4 inserts + 9 presentations. A streamlined and customized assortment.

IN STOCK

Hinged Boxes

JEWELLERY PACKAGING



COORDINATING EUROTOTE
See below and on page 76

Ring box shown with optional earring pad in place

Available Colours

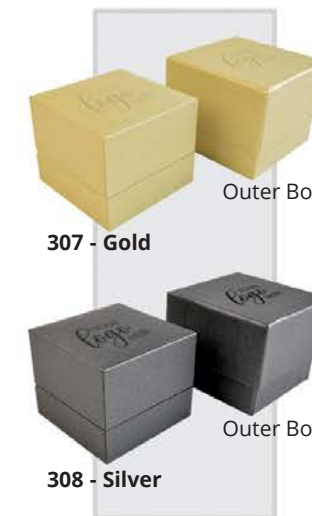

Outer Box

307 - Gold

Outer Box

308 - Silver

Vantage II

Elegant gold and silver in a linen embossed pattern.

- White satin top liners and leatherette bottom pads
- Packaged in a coordinating 3/4 depth lid 2-piece outer box



See page 50.

| CODE | DESCRIPTION | SIZE (inches) | PRICE/EACH | |
|-----------|----------------------|----------------------|------------|---------|
| | | | 12+ | 144+ |
| 36221 ___ | Ring/Earring (R1/E8) | 2 x 2 x 1.625 | \$4.77 | \$4.05 |
| 36232 ___ | T-Pad Pendant (ET14) | 2.64 x 2.72 x 2.165 | \$5.72 | \$4.86 |
| 36284 ___ | Utility T-pad (ET14) | 3.5 x 3.5 x 2 | \$6.95 | \$5.90 |
| 36293 ___ | Bracelet (BL1) | 8.625 x 2.125 x 1.25 | \$9.47 | \$8.05 |
| 36273 ___ | Necklace (N2) | 6.25 x 4.5 x 1.5 | \$11.90 | \$10.11 |

Minimum 12 per style. Please allow 2 - 3 weeks for printed items from approved art.



FOIL / PAD PRINT
F: inside liner and packer lid / PP: all 3 locations
12+ 35¢ each
144+ 32¢ each
504+ 26¢ each



50% Recycled Shell and FSC Paper Used

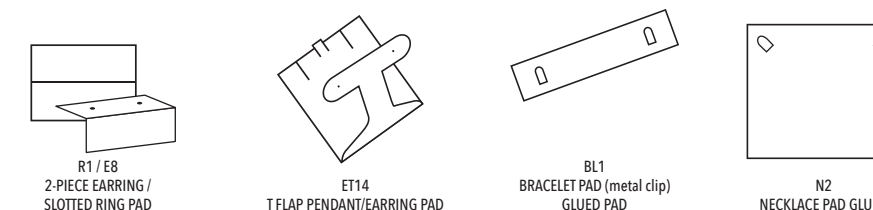

R1/E8
2-PIECE EARRING /
SLOTTED RING PAD

ET14
T FLAP PENDANT/EARRING PAD

BL1
BRACELET PAD (metal clip)
GLUED PAD

N2
NECKLACE PAD GLUED

Coordinating Eurototes

- 150 gsm uncoated paper with 8mm paper cord handles
- Minimum 100 per colour

| CODE | SIZE (inches) | PRICE/EACH | | |
|--------------|--------------------|------------|--------|--------|
| | | 100+ | 500+ | 1000+ |
| A 230606 ___ | 6 x 3.5 x 6 x 3.5 | \$1.22 | \$1.12 | \$0.96 |
| B 231008 ___ | 10.5 x 5 x 8.5 x 5 | \$1.55 | \$1.39 | \$1.19 |



07V - Gold

08V - Silver

Estimated lead time: 2 - 3 weeks for printed items from approved art.



FOIL PRINT
100+ 35¢ each
1000+ 32¢ each
2500+ 26¢ each

All print orders subject to set-up charges. Applicable artwork, and plate charges may apply. See page 122.

IN STOCK

Hinged Boxes

JEWELLERY PACKAGING



**COORDINATING
EUROTOTE**
See page 77



Glitter

Sparkle and shine with this great glittering series.

- White faux-suede pads and satin top liners
- Packaged in a black sleeve

| CODE | DESCRIPTION | SIZE (inches) | PRICE/EACH | |
|----------|----------------------|--------------------|------------|--------|
| | | | 12+ | 144+ |
| 36221183 | Ring (R1) | 1.75 x 2 x 1.5 | \$2.64 | \$2.23 |
| 36222183 | Earring (E1) | 1.75 x 2 x 1.5 | \$2.64 | \$2.23 |
| 36284183 | Utility T-pad (ET14) | 3.5 x 3.5 x 1.25 | \$4.45 | \$3.69 |
| 36293183 | Bracelet (BL1) | 8.75 x 2.125 x 1 | \$5.73 | \$4.98 |
| 36273183 | Necklace (N2) | 6.25 x 4.25 x 1.25 | \$7.30 | \$6.32 |



FOIL / PAD PRINT
F: inside liner / PP: inside top liner and box lid
12+ 35c each
144+ 32c each
504+ 26c each

Minimum 12 per style.
Please allow 2 - 3 weeks for printed items from approved art.



IN STOCK

Hinged Box

JEWELLERY PACKAGING



Available Colours



Sweetheart

Show the love with this sweet new velvet vintage inspired ring box.

- Velvet with satin top liner to put a small logo or icon
- Available in soft blush and three jewel tone colours
- Packaged in a 2-piece white outer box

| CODE | DESCRIPTION | SIZE (inches) | PRICE/EACH | |
|-------------|-------------|-----------------|------------|--------|
| | | | 12+ | 144+ |
| 36121 _ _ _ | Ring (R1) | 1.5 x 1.5 x 1.5 | \$6.50 | \$3.95 |

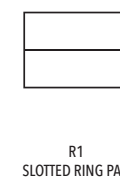

R1
SLOTTED RING PAD

FOIL / PAD PRINT
F: inside liner and packer lid / PP: inside top liner and packer lid
12+ 35c each
144+ 32c each
504+ 26c each

Minimum 12 per style.
Please allow 2 - 3 weeks for printed items
from approved art.



IN STOCK

Hinged Boxes

JEWELLERY PACKAGING



COORDINATING EUROTOTE
See page 77



Jewellers Velvet

Lasting traditions.

- Satin top liners
- Packaged in a white 2-piece outer box

| CODE | DESCRIPTION | SIZE (inches) | PRICE/EACH | |
|-----------|----------------------|-------------------|------------|--------|
| | | | 12+ | 144+ |
| 36121 ___ | Ring (R1) | 2 x 2.125 x 1.5 | \$3.51 | \$2.73 |
| 36141 ___ | Large Ring (R2) | 2.5 x 2 x 1.5 | \$4.11 | \$3.19 |
| 36122 ___ | Earring (E2) | 2 x 2.125 x 1.5 | \$3.51 | \$2.73 |
| 36132 ___ | Utility T-pad (ET14) | 2.5 x 2.5 x 1.25 | \$4.24 | \$3.32 |
| 36163 ___ | Pendant (E1) | 2.25 x 3 x 1.125 | \$4.73 | \$3.56 |
| 36183 ___ | Utility (EP4) | 3.5 x 3.375 x 1.5 | \$6.51 | \$5.12 |
| 36193 ___ | Bracelet (BL1) | 8 x 2 x 1.25 | \$7.22 | \$5.60 |
| 36173 ___ | Necklace (N2) | 7 x 4.25 x 1.5 | \$11.03 | \$8.73 |

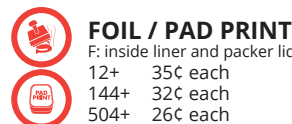
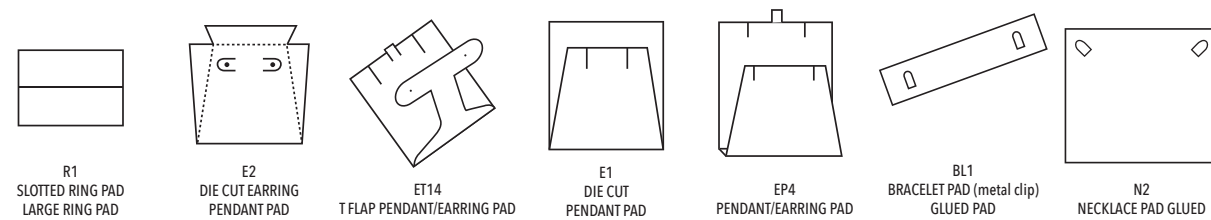

FOIL / PAD PRINT
F: inside liner and packer lid / PP: inside top liner and packer lid
12+ 35¢ each
144+ 32¢ each
504+ 26¢ each

Minimum 12 per style.
Please allow 2 - 3 weeks for printed items from approved art.



IN STOCK

Hinged Boxes

JEWELLERY PACKAGING



COORDINATING EUROTOTE
See page 77

Econoline

Lasting traditions in blue.

- Blue velour exterior
- Matching interior with white satin
- Arrives in protective white sleeve
- Optional white gloss packer

ADDITIONAL CHARGE FOR OPTIONAL 2-PIECE OUTER BOX



| CODE | DESCRIPTION | SIZE (inches) | PRICE / EACH | | 2-PIECE CONTAINER PRICE / EACH | |
|-----------|--------------------------|-----------------------|--------------|--------|--------------------------------|--------|
| | | | 12+ | 144+ | 31 | 003 |
| 36121119 | Ring (R1) | 1.875 x 2.125 x 1.375 | \$2.61 | \$2.04 | 121 | \$0.84 |
| 36141119 | Large Ring (R1) | 2.375 x 2 x 1.5 | \$2.94 | \$2.33 | 141 | \$0.89 |
| 36122119 | Earring (E2) | 1.875 x 2.125 x 1.375 | \$2.61 | \$2.04 | 121 | \$0.84 |
| 36163119 | Pendant (E1) | 2.25 x 3 x 1.125 | \$3.27 | \$2.57 | 163 | \$0.93 |
| 36132119 | T-pad Pendant (ET14) | 2.5 x 2.5 x 1.25 | \$3.46 | \$2.72 | 132 | \$0.92 |
| 36193119 | Bracelet (BL1) | 8 x 2.125 x 1 | \$6.23 | \$4.87 | 193 | \$1.17 |
| 36173119 | Necklace (N2) | 7 x 4.25 x 1.375 | \$8.58 | \$6.69 | 173 | \$1.68 |
| 36183119 | Utility (EP4) | 3.875 x 3.25 x 1.375 | \$5.99 | \$4.68 | 183 | \$1.27 |
| 69221000B | Bead Pad for earring box | | \$0.68 | \$0.56 | — | — |



Bead Pad

- pad fits stud earring box
- ribbon threads through bead
- ribbon wraps to back and is held by clip

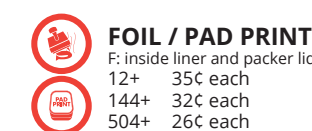
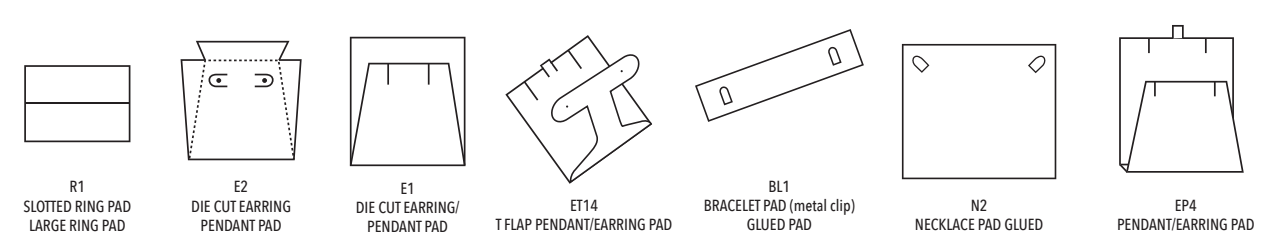

FOIL / PAD PRINT
F: inside liner and packer lid / PP: inside top liner and packer lid
12+ 35¢ each
144+ 32¢ each
504+ 26¢ each

Minimum 12 per style.
Please allow 2 - 3 weeks for printed items from approved art.



All print orders subject to set-up charges. Applicable artwork, and plate charges may apply. See page 122.

All print orders subject to set-up charges. Applicable artwork, and plate charges may apply. See page 122.

IN STOCK

Hinged Boxes

JEWELLERY PACKAGING



COORDINATING
EUROTOTE
See page 77



Outer Box

Elan

Timeless classic in all white.

- Soft, white leatherette covering
- Coordinating leatherette pads and white satin top liners
- Packaged in a white traditional 2-piece outer box

| CODE | DESCRIPTION | SIZE (inches) | PRICE/EACH | |
|----------|----------------------|----------------------|------------|--------|
| | | | 12+ | 144+ |
| 36021002 | Ring (R1) | 2 x 2.25 x 1.625 | \$5.07 | \$3.60 |
| 36041002 | Large Ring (R1) | 3 x 2 x 1.5 | \$7.45 | \$5.07 |
| 36022002 | Earring (E1) | 2 x 2.25 x 1.5 | \$5.07 | \$3.60 |
| 36084002 | Utility T-pad (ET14) | 3.5 x 3.5 x 1.375 | \$7.73 | \$5.44 |
| 36093002 | Bracelet (BL1) | 8.625 x 2.25 x 1 | \$11.79 | \$8.00 |
| 36073002 | Necklace (N2) | 7.125 x 4.375 x 1.25 | \$14.63 | \$9.85 |



FOIL / PAD PRINT
F: inside liner and packer lid / PP: all 3 locations
12+ 35¢ each
144+ 32¢ each
504+ 26¢ each

Minimum 12 per style.
Please allow 2 - 3 weeks for printed items from approved art.



IN STOCK

Hinged Boxes

JEWELLERY PACKAGING

COORDINATING
EUROTOTE
See page 77



ADDITIONAL
CHARGE FOR OPTIONAL 2-PIECE
OUTER BOX



Outer Sleeve

Econolux

Style meets value.

- Soft, white leatherette covering
- White suedine pads and satin top liners
- Packaged in a white tuck outer box (2-piece traditional outer box available)

| CODE | DESCRIPTION | SIZE (inches) | PRICE /EACH | | 2-PIECE CONTAINER PRICE /EACH | |
|-----------|--------------------------|-----------------------|-------------|--------|-------------------------------|--------|
| | | | 12+ | 144+ | 31 | 003 |
| 36121002 | Ring (R1) | 1.875 x 2.125 x 1.375 | \$2.93 | \$2.05 | 121 | \$0.84 |
| 36141002 | Large Ring (R1) | 2.375 x 2 x 1.5 | \$3.31 | \$2.31 | 141 | \$0.89 |
| 36122002 | Earring (E2) | 1.875 x 2.125 x 1.375 | \$2.93 | \$2.05 | 121 | \$0.84 |
| 36163002 | Pendant (E1) | 2.25 x 3 x 1.125 | \$3.53 | \$2.72 | 163 | \$0.93 |
| 36132002 | T-pad Pendant (ET14) | 2.5 x 2.5 x 1.25 | \$3.30 | \$2.69 | 132 | \$0.92 |
| 36193002 | Bracelet (BL1) | 8 x 2.125 x 1 | \$6.58 | \$5.15 | 193 | \$1.17 |
| 36173002 | Necklace (N2) | 7 x 4.25 x 1.375 | \$9.06 | \$6.80 | 173 | \$1.68 |
| 36183002 | Utility (EP4) | 3.875 x 3.25 x 1.375 | \$6.36 | \$4.44 | 183 | \$1.27 |
| 69221000B | Bead Pad for earring box | | \$0.68 | \$0.56 | — | — |



Bead Pad
• pad fits stud earring box
• ribbon threads through bead
• ribbon wraps to back and is held by clip

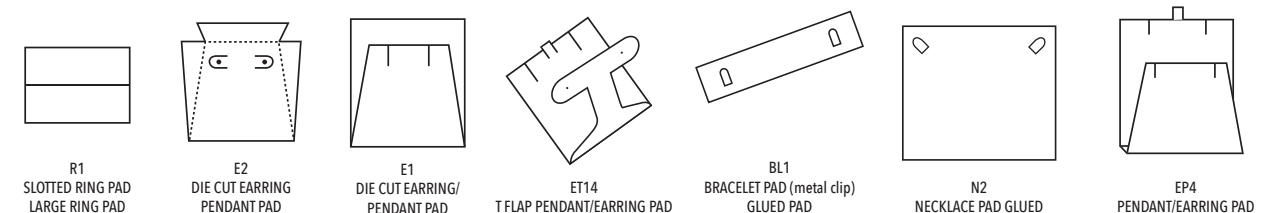

FOIL / PAD PRINT
F: inside liner and packer lid / PP: all 3 locations
12+ 35¢ each
144+ 32¢ each
504+ 26¢ each

Minimum 12 per style.
Please allow 2 - 3 weeks for printed items from approved art.



All print orders subject to set-up charges. Applicable artwork, and plate charges may apply. See page 122.

All print orders subject to set-up charges. Applicable artwork, and plate charges may apply. See page 122.

IN STOCK

Hinged Boxes

Deliver the 'in-store' experience to your customer's door. See page 101 for more information

COORDINATING EUROTOTE
See page 77



Gold Galleria

A new gold standard.

- White velour pads and satin top liners
- Packaged in a white traditional 2-piece outer box

| CODE | DESCRIPTION | SIZE (inches) | PRICE/EACH | |
|-----------|--------------------------|---------------------|------------|------|
| | | | 12+ | 144+ |
| 36621073 | Ring (R1) | 2.125 x 2 x 2 | \$2.15 | |
| 36622073 | Earring (E1) | 2.125 x 2 x 2 | N/A | |
| 36641073 | Large Ring (R1) | 3 x 2 x 2 | N/A | |
| 36684073 | Utility T-pad (ET14) | 3.5 x 3.5 x 1.5 | \$3.05 | |
| 36693073 | Bracelet (BL1) | 8.25 x 2.125 x 1.25 | \$4.70 | |
| 36673073 | Necklace (N2) | 6.25 x 5 x 1.5 | N/A | |
| 36650073 | Bangle (R1) | 1.25 x 3.75 x 3.125 | N/A | |
| 69621000B | Bead Pad for earring box | | \$0.68 | |

E-Commerce Jewellery Boxes



E-Commerce Jewellery Boxes

Deliver the 'in-store' experience to your customer's door. See page 101 for more information

COORDINATING EUROTOTE
See page 77



Available Colours



003 - White



663 - Burgundy



153 - Black

Horizon

The gold standard in a classic white, burgundy and black.

- White velour pads and satin top liners
- Packaged in a white traditional 2-piece outer box

| CODE | DESCRIPTION | SIZE (inches) | 12+ | 144+ |
|-----------|--------------------------|---------------------|---------|--------|
| 36621 ___ | Ring (R1) | 2.125 x 2 x 2 | \$3.74 | \$2.91 |
| 36622 ___ | Earring (E1) | 2.125 x 2 x 2 | \$3.74 | \$2.91 |
| 36641 ___ | Large Ring (R1) | 3 x 2 x 2 | \$4.27 | \$3.47 |
| 36684 ___ | Utility T-pad (ET14) | 3.5 x 3.5 x 1.5 | \$5.38 | \$4.31 |
| 36632 ___ | T-Pad Pendant (ET14) | 2.75 x 2.75 x 1.375 | \$5.33 | \$4.17 |
| 36693 ___ | Bracelet (BL1) | 8.25 x 2.125 x 1.25 | \$7.03 | \$5.72 |
| 36673 ___ | Necklace (N2) | 6.25 x 5 x 1.5 | \$11.03 | \$8.66 |
| 36650 ___ | Bangle (R1) | 1 x 3.75 x 3.125 | \$4.59 | \$3.95 |
| 69621000B | Bead Pad for earring box | | \$0.68 | \$0.68 |

| BLACK PADS AVAILABLE (3 SIZES) | | | | |
|--------------------------------|--------------------------|-------------|-----------|---------------|
| 36621153B | Single Ring Pad (black) | 2.125 X 2 | box w/pad | \$3.74 \$2.91 |
| 69622153B | Stud Earring Pad (black) | 2.125 x 2 | pad only | \$0.34 \$0.34 |
| 69633153B | Pend/Earring Pad (black) | 2.75 x 2.75 | pad only | \$1.09 \$1.09 |

Outer Box



Bead Pad

- pad fits stud earring box
- ribbon threads through bead
- ribbon wraps to back and is held by clip



Bead Pad

- pad fits stud earring box
- ribbon threads through bead
- ribbon wraps to back and is held by clip



FOIL / PAD PRINT
F: inside liner and packer lid / PP: all 3 locations
12+ 35¢ each
144+ 32¢ each
504+ 26¢ each

Minimum 12 per style.
Please allow 2 - 3 weeks for printed items from approved art.



FOIL / PAD PRINT
F: inside liner and packer lid / PP: all 3 locations
12+ 35¢ each
144+ 32¢ each
504+ 26¢ each

Minimum 12 per style.
Please allow 2 - 3 weeks for printed items from approved art.



IN STOCK

Jewellery Packaging

JEWELLERY PACKAGING



Available Colours



Nano Clutch

Perfect for gifting and on the go, this collection is going places!

- Linea envelope, and pad
- Packaged in a 2-piece matching outer box

| CODE | DESCRIPTION | SIZE (inches) | PRICE/EACH | |
|-------|-----------------|---------------|------------|--------|
| | | | 12+ | 144+ |
| 09121 | Ring (R1) | 2.55 X 2.55 | \$2.49 | \$2.30 |
| 09163 | Pendant (P3) | 4 X 4 | \$3.04 | \$2.80 |
| 09193 | Bracelet (BL1R) | 9.625 X 3.125 | \$4.19 | \$3.85 |
| 09173 | Necklace (N1) | 6.625 X 6.625 | \$5.72 | \$5.27 |

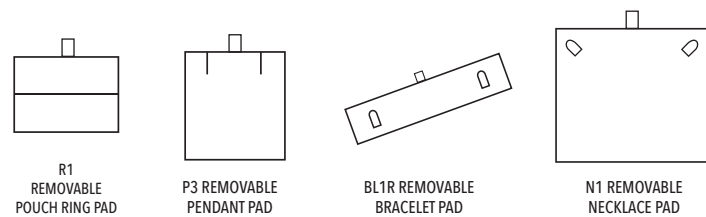

FOIL / PAD PRINT
 F: outside flap and packer / PP: outside flap and packer
 12+ 35¢ each
 144+ 32¢ each
 504+ 26¢ each

Minimum 12 per style.
 Please allow 2 - 3 weeks for printed items from approved art.



IN STOCK

Specialty

JEWELLERY PACKAGING



The Drawer Box

Eco-friendly, on trend series.

- Removable reusable recycled pads
- Fixed ring pad with foam
- Made with 100% recyclable Paper Board
- Coordinates with the Nano Pouch for a stunning reveal (earring & pendant)



Minimum one case pack.
 Please allow 2 - 3 weeks for printed items from approved art.



| CODE | DESCRIPTION | SIZE (inches) | CASE PACK | PRICE/EACH | |
|----------|-----------------|--------------------|-----------|------------|--------|
| | | | | 50+ | 500+ |
| 31050603 | Ring (R1) | 2.24 x 2.36 x 1.98 | 50 | \$2.54 | \$2.03 |
| 31070703 | Earring Utility | 2.75 x 2.83 x 1.57 | 50 | \$2.92 | \$2.34 |
| 31101003 | Pendant Utility | 3.93 x 4 x 1.57 | 50 | \$3.82 | \$3.06 |

PAD PRINT
 PP: box top
 50+ 35¢ each
 500+ 32¢ each
 2500+ 26¢ each

Vision Box

Unique transparent 3D window box with coordinating display stand.

- Transparent puncture resistant elastic film
- Conforms to hold any jewellery piece
- Coordinating display base (extra)



| CODE | DESCRIPTION | SIZE (inches) | PRICE/EACH | |
|----------|------------------|-------------------|------------|--------|
| | | | 12+ | 144+ |
| 36301103 | Small | 2.68 x 2.68 x .75 | \$1.19 | \$0.95 |
| 36302103 | Medium | 3.5 x 3.5 x .75 | \$1.59 | \$1.27 |
| 36303103 | Large | 4.25 x 4.25 x .75 | \$1.99 | \$1.59 |
| 69300103 | Base (pkg of 12) | 2.25 x 2.25 x .62 | \$0.99 | \$0.73 |

PAD PRINT
 PP: side of lid - text only - limited space
 12+ 35¢ each
 144+ 32¢ each
 504+ 26¢ each

Minimum 12 per style.
 Please allow 2 - 3 weeks for printed items from approved art.

All print orders subject to set-up charges. Applicable artwork, and plate charges may apply. See page 122.

All print orders subject to set-up charges. Applicable artwork, and plate charges may apply. See page 122.

CREATE
YOUR OWN LOOK

JEWELLERY PACKAGING



PAPERBOARD SERIES

Stylized lines and the geometric pattern gives this collection an art deco feel.

IN STOCK
Paperboard Hinged

JEWELLERY PACKAGING



COORDINATING
EUROTOTE
See page 79

Outer Sleeve

Deco

Iconic black and white.

- Paperboard construction, covered in smooth laminate paper
- Flocked reversible black and white foam pads
- Packaged in individual white sleeves

| CODE | DESCRIPTION | SIZE (inches) | CASE PACK | PRICE/EACH | |
|-----------|--------------------|-------------------|-----------|------------|--------|
| | | | | 50+ | 500+ |
| 31621153D | Ring (R1H) | 2 x 2 x 1 | 50 | \$1.60 | \$1.35 |
| 31622153D | Earring (P3) | 2 x 2 x 1 | 50 | \$1.60 | \$1.35 |
| 31632153D | Large Earring (P3) | 2.5 x 2.5 x 1.75 | 50 | \$2.08 | \$1.76 |
| 31684153D | Utility (P2) | 3.75 x 3.75 x 1.5 | 50 | \$3.29 | \$2.80 |
| 31693153D | Bracelet (BL1) | 9 x 2 x 1.125 | 50 | \$3.45 | \$2.93 |
| 31673153D | Necklace (N2) | 6.5 x 8 x 2 | 50 | \$7.43 | \$6.31 |



Pads are removable and reversible. Choose white flock or black flock.



Recycled Paperboard

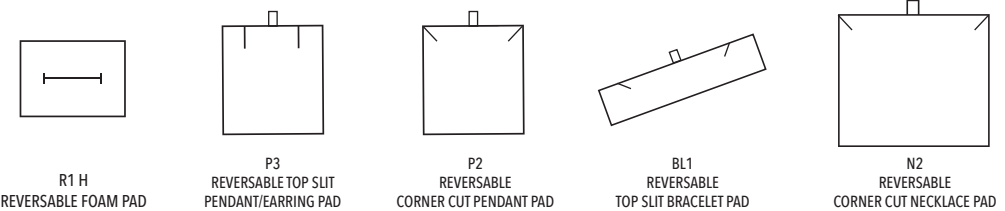

FOIL / PAD PRINT
F: inside and top lid / PP: inside and top lid
50+ 35c each
500+ 32c each
2500+ 26c each

Minimum one case pack.
Please allow 2 - 3 weeks for printed items from approved art.

All print orders subject to set-up charges. Applicable artwork, and plate charges may apply. See page 122.

IN STOCK

2-Piece Boxes

JEWELLERY PACKAGING

COORDINATING
EUROTOTE
See page 76



E-Commerce Jewellery Boxes

Deliver the 'in-store' experience to your customer's door



See page 101 for more information

Available Colours



273 - Bronze



153 - Black

Velocity

Organza ribbon and classic boxes make for perfect partners.

- Texture paper wrapped 2-piece boxes with white flocked foam pads
- Coordinating organza ribbon
- Match with Bronze Geo series and Geo Eurototes

| CODE | DESCRIPTION | SIZE (inches) | CASE PACK | PRICE/EACH | |
|-----------|----------------|----------------|-----------|------------|--------|
| | | | | 25+ | 1000+ |
| 31221 ___ | Ring (R1) | 2.5 x 2.25 x 2 | 50 | \$2.28 | \$1.87 |
| 31283 ___ | Utility (E1) | 3 x 3 x 2 | 50 | \$3.15 | \$2.61 |
| 31293 ___ | Bracelet (BL2) | 9 x 2.25 x 1.5 | 25 | \$4.33 | \$3.56 |
| 31273 ___ | Necklace (N1) | 6.25 x 8 x 2 | 25 | \$5.67 | \$4.93 |

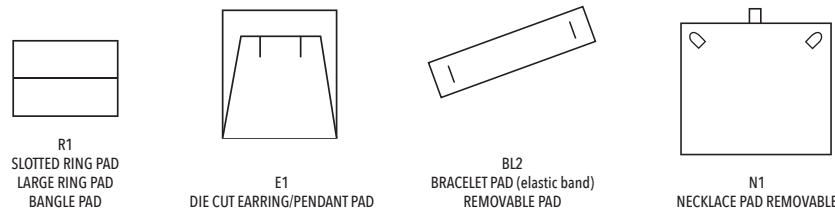

FOIL / PAD PRINT
F: inside and top lid / PP: inside and top lid
25/50+ 35¢ each
1000+ 32¢ each
2500+ 26¢ each

Minimum one case pack.
Please allow 2 - 3 weeks for printed items from approved art.



IN STOCK

2-Piece Boxes

JEWELLERY PACKAGING

NEW! COORDINATING
ALL PAPER EUROTOTE
See page 79



Romance

Perfect partners in ivory and gold.

- Texture paper wrapped 2-piece boxes with white flocked foam pads
- Coordinating organza ribbon
- Match with Cream All Paper Eurototes

| CODE | DESCRIPTION | SIZE (inches) | CASE PACK | PRICE/EACH | |
|----------|----------------|-----------------|-----------|------------|--------|
| | | | | 50+ | 1000+ |
| 31221863 | Ring (R1) | 2.5 x 2.25 x 2 | 100 | \$2.06 | \$1.87 |
| 31222863 | Earring (E1) | 2 x 1.5 x 1.187 | 100 | \$1.97 | \$1.68 |
| 31263863 | Utility (P3) | 3 x 3 x 2.125 | 100 | \$2.35 | \$2.02 |
| 31293863 | Bracelet (BL1) | 9 x 2.375 x 1.5 | 50 | \$3.53 | \$2.98 |
| 31273863 | Necklace (N2) | 6.375 x 8 x 2 | 50 | N/A | |

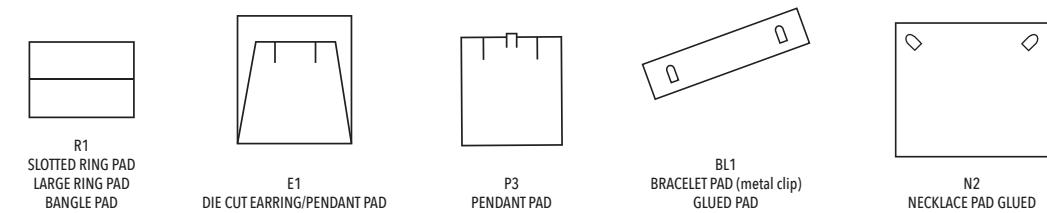

FOIL / PAD PRINT
F: inside and top lid / PP: inside and top lid
50/100+ 35¢ each
1000+ 32¢ each
2500+ 26¢ each

Minimum one case pack.
Please allow 2 - 3 weeks for printed items from approved art.



All print orders subject to set-up charges. Applicable artwork, and plate charges may apply. See page 122.

All print orders subject to set-up charges. Applicable artwork, and plate charges may apply. See page 122.

IN STOCK

2-Piece Boxes

JEWELLERY PACKAGING



COORDINATING EUROTOTE
See pages 77

Shadow

Shimmery grey exterior, featuring a wave reveal.

- Texture paper wrapped 2-piece boxes with white flocked foam pads
- Match with Rope Handle Eurototes
- No packer/no sleeve

| CODE | DESCRIPTION | SIZE (inches) | CASE PACK | PRICE/EACH | |
|----------|----------------------|------------------|-----------|------------|--------|
| | | | | 50+ | 1000+ |
| 31511308 | Charm (C1) | 2 x 2 x 1 | 100 | \$1.48 | \$1.23 |
| 31521308 | Ring/Earring (R1H) | 2 x 2 x 1.75 | 100 | \$1.81 | \$1.44 |
| 31563308 | Pendant/Earring (P2) | 3.5 x 3.5 x 1.25 | 50 | N/A | N/A |
| 31593308 | Bracelet (BL2) | 9 x 2 x 1 | 50 | N/A | N/A |
| 31573308 | Necklace (N1) | 6 x 6 x 1.5 | 50 | \$5.50 | \$4.29 |

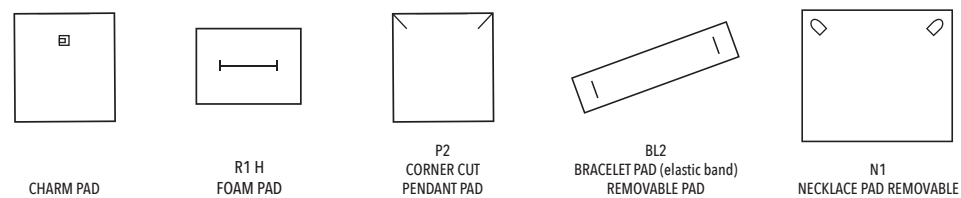

FOIL / PAD PRINT
F: inside and top lid / PP: inside and top lid
50/100+ 35¢ each
1000+ 32¢ each
2500+ 26¢ each

Minimum one case pack.
Please allow 2 - 3 weeks for printed items from approved art.



IN STOCK

Paperboard Hinged

JEWELLERY PACKAGING



COORDINATING EUROTOTE
See pages 77

Royale

Hinged, white paperboard boxes covered in finely ribbed paper with gold accent lines.

- Texture paper wrapped hinged boxes with white flocked foam pads
- Match with Rope Handle Eurototes
- Packaged in individual white sleeves

| CODE | DESCRIPTION | SIZE (inches) | CASE PACK | PRICE/EACH | |
|----------|----------------------|-------------------|-----------|------------|--------|
| | | | | 50+ | 1000+ |
| 31545003 | Ring/Earring (R1H) | 2.5 x 2 x 1.5 | 100 | \$1.43 | \$1.30 |
| 31533003 | Pendant/Earring (P2) | 2.75 x 2.75 x 1 | 100 | \$1.70 | \$1.50 |
| 31560003 | Utility (P3) | 3.5 x 3.5 x 1 | 50 | \$2.08 | \$1.82 |
| 31580003 | Bracelet (BL2) | 8.125 x 2.125 x 1 | 50 | \$2.68 | \$2.41 |
| 31575003 | Necklace (N1) | 6.5 x 4.5 x 1 | 50 | \$4.13 | \$3.58 |

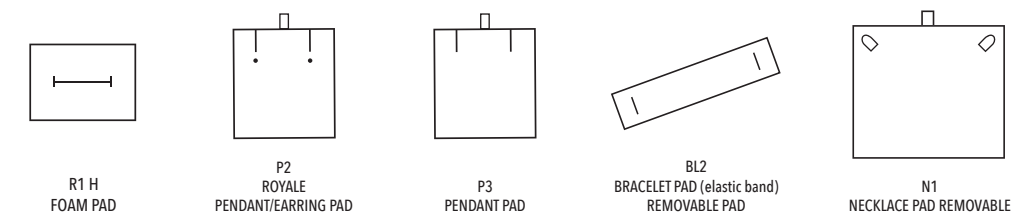

FOIL / PAD PRINT
F: inside and top lid / PP: inside and top lid
50/100+ 35¢ each
1000+ 32¢ each
2500+ 26¢ each

Minimum one case pack.
Please allow 2 - 3 weeks for printed items from approved art.



All print orders subject to set-up charges. Applicable artwork, and plate charges may apply. See page 122.

All print orders subject to set-up charges. Applicable artwork, and plate charges may apply. See page 122.

SPECIAL ORDER

Nest Boxes



JEWELLERY PACKAGING

JEWELLERY PACKAGING

SPECIAL ORDER

Nest Boxes



| CODE | PRICE /EACH | |
|-------|-------------|--------|
| | 50+ | 1000+ |
| 31011 | \$0.93 | \$0.84 |
| 31021 | \$0.99 | \$0.90 |
| 31032 | \$1.17 | \$1.06 |
| 31033 | \$1.39 | \$1.26 |
| 31036 | \$1.56 | \$1.42 |
| 31034 | \$1.70 | \$1.14 |
| 31053 | \$1.62 | \$1.47 |
| 31065 | \$2.27 | \$2.06 |
| 31082 | \$1.53 | \$1.39 |
| 31085 | \$2.89 | \$2.63 |



Cotton Filled Nest Boxes

Mix & Match!

Available Colours



| CODE | SIZE (inches) | CASE PACK | 061 | 000K | 007 | 008 | 009 | 029 | 354 | 353 | 045 | 155 | 015P | 055 | 093 |
|-------|---------------------|-----------|-----|------|-----|-----|-----|-----|-----|-----|-----|-----|------|-----|-----|
| 31011 | 1.75 x 1.125 x .625 | 100 | ✓ | ✓ | ✓ | ✓ | - | - | - | - | - | ✓ | ✓ | - | - |
| 31021 | 2.5 x 1.5 x .875 | 100 | ✓ | ✓ | ✓ | ✓ | ✓ | ✓ | ✓ | ✓ | ✓ | ✓ | ✓ | ✓ | ✓ |
| 31032 | 3 x 2.125 X 1 | 100 | ✓ | ✓ | ✓ | ✓ | ✓ | ✓ | ✓ | ✓ | ✓ | ✓ | ✓ | ✓ | ✓ |
| 31033 | 3.5 x 3.5 x 1 | 100 | ✓ | ✓ | ✓ | ✓ | ✓ | ✓ | ✓ | ✓ | ✓ | ✓ | ✓ | ✓ | ✓ |
| 31036 | 3.5 x 3.5 x 1.5 | 100 | - | ✓ | ✓ | ✓ | - | - | - | - | - | ✓ | ✓ | ✓ | - |
| 31034 | 3.5 x 3.5 x 2 | 100 | - | ✓ | ✓ | ✓ | - | - | - | - | - | ✓ | ✓ | ✓ | - |
| 31053 | 5.25 x 3.75 x .875 | 100 | ✓ | ✓ | ✓ | ✓ | ✓ | ✓ | ✓ | ✓ | ✓ | ✓ | ✓ | ✓ | ✓ |
| 31065 | 6 x 5 x 1 | 50 | - | ✓ | ✓ | ✓ | ✓ | ✓ | ✓ | - | ✓ | ✓ | ✓ | ✓ | ✓ |
| 31082 | 8 x 2 x .875 | 100 | - | ✓ | ✓ | ✓ | ✓ | - | ✓ | - | - | ✓ | ✓ | ✓ | ✓ |
| 31085 | 8 x 5.5 x 1.25 | 50 | ✓ | ✓ | ✓ | - | - | - | - | - | - | - | ✓ | - | - |



| CODE | SIZE (inches) | CASE PACK | 098 | 099 | 060 | 056 | 028 | 025 | 026 | 076 | 075 | 081 | 067 | 019 |
|-------|---------------------|-----------|-----|-----|-----|-----|-----|-----|-----|-----|-----|-----|-----|-----|
| 31011 | 1.75 x 1.125 x .625 | 100 | - | - | ✓ | - | - | - | - | ✓ | ✓ | - | - | - |
| 31021 | 2.5 x 1.5 x .875 | 100 | ✓ | ✓ | ✓ | ✓ | ✓ | ✓ | ✓ | ✓ | ✓ | ✓ | ✓ | ✓ |
| 31032 | 3 x 2.125 X 1 | 100 | ✓ | ✓ | ✓ | ✓ | ✓ | ✓ | ✓ | ✓ | ✓ | ✓ | ✓ | ✓ |
| 31033 | 3.5 x 3.5 x 1 | 100 | ✓ | ✓ | ✓ | ✓ | ✓ | ✓ | ✓ | ✓ | ✓ | ✓ | ✓ | ✓ |
| 31036 | 3.5 x 3.5 x 1.5 | 100 | - | - | - | ✓ | - | - | - | ✓ | ✓ | - | - | - |
| 31034 | 3.5 x 3.5 x 2 | 100 | - | - | - | ✓ | - | ✓ | - | ✓ | ✓ | - | - | - |
| 31053 | 5.25 x 3.75 x .875 | 100 | ✓ | ✓ | ✓ | ✓ | ✓ | ✓ | ✓ | ✓ | ✓ | ✓ | ✓ | ✓ |
| 31065 | 6 x 5 x 1 | 50 | ✓ | ✓ | ✓ | ✓ | - | ✓ | ✓ | ✓ | ✓ | ✓ | - | - |
| 31082 | 8 x 2 x .875 | 100 | - | ✓ | ✓ | ✓ | - | - | - | ✓ | ✓ | - | - | - |
| 31085 | 8 x 5.5 x 1.25 | 50 | - | - | ✓ | - | - | - | - | ✓ | ✓ | - | - | - |

Berkeley

Simple yet striking keyline design collection.

- Gloss paper
- Fully customizable
- White flocked platform inserts



100% Recycled Board

Available Colours



| CODE | SIZE (inches) | CASE PACK | PRICE/EACH | |
|-------|---------------|-----------|------------|--------|
| | | | 100+ | 1000+ |
| 32201 | 3 x 3 x 1.25 | 100 | \$1.84 | \$1.75 |
| 32202 | 3.5 x 3.5 x 2 | 100 | \$2.79 | \$2.64 |
| 32203 | 5 x 5 x 1.5 | 100 | \$3.49 | \$3.31 |
| 32204 | 9 x 4.5 x 2* | 100 | \$4.38 | \$4.15 |

* 849 - Red and 505 - Kraft are not available in this size.

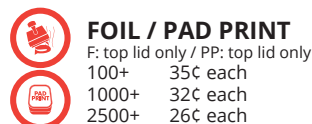

FOIL / PAD PRINT
 F: top lid only / PP: top lid only
 100+ 35¢ each
 1000+ 32¢ each
 2500+ 26¢ each

Minimum one case pack.
 Estimated lead time - Please allow 3 weeks for unprinted items and 4 weeks for printed items from approved art.

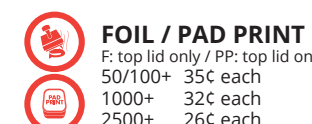

FOIL / PAD PRINT
 F: top lid only / PP: top lid only
 50/100+ 35¢ each
 1000+ 32¢ each
 2500+ 26¢ each

Minimum one case pack.
 Estimated lead time - Please allow 3 weeks for unprinted items and 4 weeks for printed items from approved art.

All print orders subject to set-up charges. Applicable artwork, and plate charges may apply. See page 122.

All print orders subject to set-up charges. Applicable artwork, and plate charges may apply. See page 122.

IN STOCK

Nest Boxes



These boxes match our **Damask Paper Shoppers** - page 85 and **Damask Pouches** - page 54

Damask

Style and substance in a simple packaging combination.

- Black and white 2-piece box
- 100% recycled board box
- Cotton fill pad wrapped with damask patterned tissue
- See our matching bag and pouch to complete your collection

| CODE | DESCRIPTION | SIZE (inches) | CASE PACK | 100+ | 1000+ |
|-----------|-------------|---------------|-----------|--------|--------|
| 31570153D | Earring | 3 x 2.125 x 1 | 100 | \$0.75 | \$0.65 |
| 31555153D | Brooch | 3.5 x 3.5 x 1 | 100 | \$0.89 | \$0.76 |
| 31564153D | Bracelet | 8 x 2 x .875 | 100 | \$1.04 | \$0.90 |
| 31558153D | Necklace | 6 x 5 x 1 | 100 | \$1.51 | \$1.28 |

Minimum order is one case pack.

White Swirl Pattern



White Economy

Sometimes a simple box is all you need!

- Made with 100% recycled board covered with white swirl paper
- Cotton filled to hold jewellery in place

| CODE | DESCRIPTION | SIZE (inches) | CASE PACK | 50+ | 1000+ |
|----------|-----------------|------------------|-----------|--------|--------|
| 31502103 | Charm | 2.5 x 1.5 x .875 | 100 | \$0.64 | \$0.57 |
| 31570103 | Earring | 3 x 2.125 x 1 | 100 | \$0.72 | \$0.60 |
| 31555103 | Brooch | 3.5 x 3.5 x 1 | 100 | \$0.82 | \$0.73 |
| 31564103 | Bracelet | 8 x 2 x .875 | 100 | \$0.92 | \$0.82 |
| 31558103 | Necklace | 6 x 5 x 1 | 50 | \$1.18 | \$1.06 |
| 31576103 | Large Necklace | 8 x 5.5 x 1.25 | 50 | \$1.82 | \$1.58 |
| 31259103 | Stand-Up Bangle | 3.5 x 2 x 2 x 2 | 100 | \$2.36 | \$2.12 |

Minimum order is one case pack.



100% Recycled Board



FOIL / PAD PRINT

F: top lid only / PP: top lid only
 100+ 35¢ each
 1000+ 32¢ each
 2500+ 26¢ each

Estimated lead time: 2 - 3 weeks for printed items from approved art.



100% Recycled Board



FOIL / PAD PRINT

F: packer lid / PP: packer lid
 50/100+ 35¢ each
 1000+ 32¢ each
 2500+ 26¢ each

Estimated lead time: 2 - 3 weeks for printed items from approved art.

All print orders subject to set-up charges. Applicable artwork, and plate charges may apply. See page 122.

IN STOCK

Jewellery Folders



Passport Jewellery Folders

Designed with stylish envelope closure, snaps tight to keep jewels secure.

- Linea exteriors, satin interior
- Packaged in a 2-Piece white outer box
- Two colours soft white and black
- Case pack of 12

| CODE | DESCRIPTION | SIZE (inches) | 12+ | 144+ |
|--------|----------------|---------------|--------|--------|
| 367950 | Bracelet | 8.25 x 1.75 | \$5.62 | \$4.78 |
| 367900 | Necklace/Pearl | 6 x 8 | \$9.36 | \$8.00 |



FOIL / PAD PRINT

Bracelet: F and PP: inside bottom flap and packer lid
 Necklace: PP: top flap / F and PP: inside flap and packer lid
 12+ 35¢ each
 144+ 32¢ each
 504+ 26¢ each

Estimated lead time: 2 - 3 weeks for printed items from approved art.



Global Jewellery Folders

Wide gusset folder for larger pieces.

- Bronze and pearl linea
- Black faux suede
- Satin interior and magnetic closure
- Packaged in a 2-Piece matching outer box
- Case pack of 12

| CODE | SIZE (in.) | 12+ | 144+ |
|-------|------------|---------|--------|
| 36790 | 5.5 x 7.5 | \$11.89 | \$9.98 |



FOIL / PAD PRINT

PP: top flap / F and PP: inside flap and packer lid
 12+ 35¢ each
 144+ 32¢ each
 504+ 26¢ each

Estimated lead time: 2 - 3 weeks for printed items from approved art.

Hoop Earring Folder

Black ultrasuede folder with top stitch finish and black interior. Holds hoop earrings up to 2.75" in diameter.

- Packaged in a white 2-Piece outer box
- Case pack of 12

| CODE | SIZE (in.) | 12+ | 144+ |
|----------|------------|--------|--------|
| 36791015 | 4.5 x 4.5 | \$4.38 | \$3.77 |



FOIL / PAD PRINT

F: packer lid / PP: packer lid
 12+ 35¢ each
 144+ 32¢ each
 504+ 26¢ each

Estimated lead time: 2 - 3 weeks for printed items from approved art.

All print orders subject to set-up charges. Applicable artwork, and plate charges may apply. See page 122.

CREATE YOUR OWN LOOK

TELL YOUR BRAND STORY CREATE YOUR UNIQUE IDENTITY



Create Your Own Look
in 7 Easy Steps

Speak to your
sales representative
for a consultation.

Looking for 100% custom design? Design your very own jewellery packaging.

STEP 1:

Choose your box style.
We have access to endless design and looks. You dream it, we can create it.
Choose from wood, plastic, MDF and paperboard shells.
Select hinged or 2-piece.
MOQ:
Plastic or Metal 2,500
Wood 1,000
Paperboard 5,000

STEP 2:

Choose your covering and colour.
Leatherette, velvet, paper.
Design your texture—hundreds to choose from, or create your own. Brushed leatherette, embossed papers, smooth, textured.
Select from our colour books, or use Pantone to specify your exact colours.

STEP 3:

Specify the interior.
Select pad colour and material for inside lid.
Leatherette, brushed leatherette, flocked, velvet, velour.
Decide on the top interior material—leatherette, brushed leatherette, satin, flocked, velvet.
Select colour—white, black, ivory are most common.
Option—create a reveal with contrasting colour.

STEP 4:

Design your packer.
2-piece box or sleeve.
Often you can use the same material or create a coordinating colour.
Option -- add die cuts at bottom for ribbon, and/or reveal for contrasting colour.

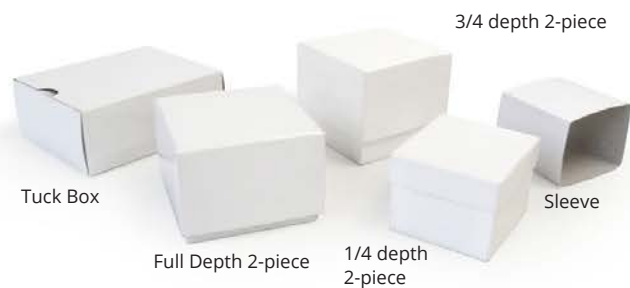

STEP 5:

Design logo placement.
Areas to consider:
Inside box lid (Top Satin)
Packer Lid (can be centered, or placed at lower corner if using ribbon)
Top Lid



STEP 6:

Select your pad designs. (See page 51)

STEP 7:

Email your artwork.
Artwork ultimately needs to be in Vector file format. Your graphic designers should be able to assist you. Gunther Mele is also available to provide artwork assistance and full service design, cost is \$75/hour, min half hour charge.

CYOL has 16-20 weeks lead time. (Time frames based on signed approved artwork, quote and deposit).
Printing and pre-production samples included at no extra charge.

Please note:

Logos with intricate lines and details (such as diamonds), often will not translate in small print areas, such as top satins. Designs with text and simple outlines work best for inside of ring boxes, etc. Repls and our designers will advise you when artwork should be modified to produce best results.

To ensure accuracy and best quality, signatures are required on all artwork documents and quote documents where noted. Production will not commence until all artwork, quotes and deposits are finalized and signed off. Your rep is available to work with you to ensure all documentation is completed to prevent delays. Please ensure your email access is update date.

Complete your look!

Bags, Tissue, Pouches, Ribbon, Displays, Necklace folders, and more!

Select from our in stock or create your own. Gunther Mele is your one stop for all your needs.

Our sales representative can help you design all your packaging and displays to tell your unique brand story.

CREATE YOUR OWN LOOK

RING PADS

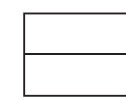

R1
SLOTTED PAD

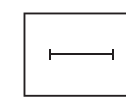

R1 H
FOAM PAD

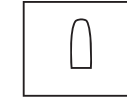

R2
EUROPEAN STYLE
CLIP PAD

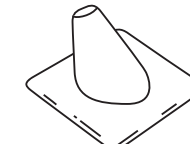

R4
FINGER



R1 8
RING ROLL

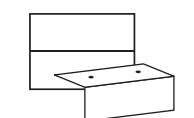

2-PIECE EARRING /
R1 SLOTTED RING PAD

EARRING PADS

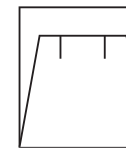

E1
DIE CUT
EARRING/PENDANT PAD

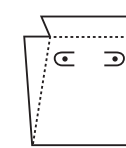

E2
DIE CUT
EARRING/PENDANT PAD

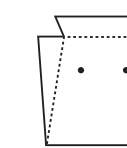

E3
DIE CUT
EARRING/PENDANT PAD

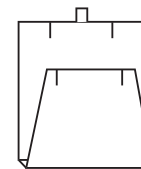

EP4
EARRING/PENDANT
PAD

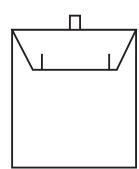

E4 SLITS
EARRING PAD

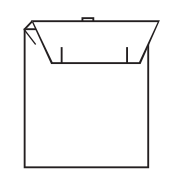

E8
LEVER BACK
EARRING PAD

EARRING/ PENDANT PADS

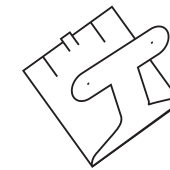

ET14
T FLAP
PENDANT/EARRING PAD

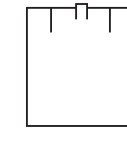

P3
PENDANT PAD

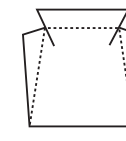

P5
DIE CUT
PENDANT PAD

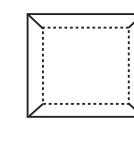

U1
DIE CUT
WELL PAD

BRACELET AND WATCH PADS

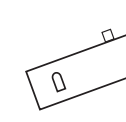

BL1R
REMOVABLE
BRACELET PAD

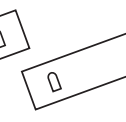

BL1
BRACELET PAD
(metal clip)
GLUED PAD

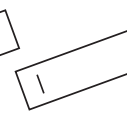

BL2
BRACELET PAD
(elastic band)
GLUED PAD

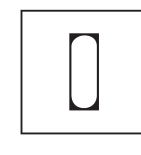

W1
DIE CUT
(removable metal collar)

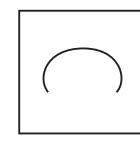

W3
DIE CUT
(metal "C")

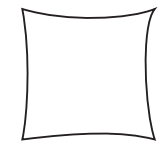

PL1
PILLOW

NECKLACE PADS

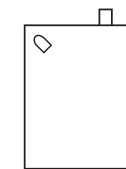

N1
REMOVABLE
NECKLACE PAD

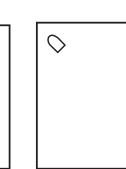

N2
NECKLACE PAD
GLUED

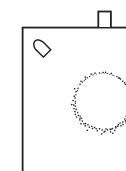

N3
REMOVABLE
NECKLACE PAD

TRIPLE FLIP PADS

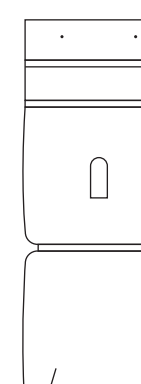

T1
TRIPLE FLIP
RING/PENDANT/EARRING PAD

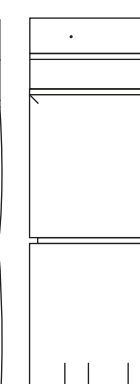

T2
TRIPLE FLIP
PENDANT/EARRING PAD

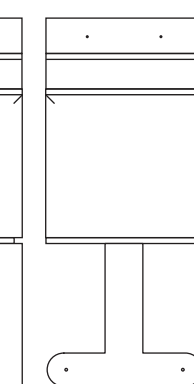

T3
TRIPLE FLIP
PENDANT/EARRING/
HOOP PAD

IN STOCK

Gift Card Boxes



Gift Cards
Not Included.

Black Gift Card Box with Ribbon

Estimated lead time: 2 - 3 weeks for printed items from approved art.
Minimum order is one case pack.

| CODE | SIZE (inches) | CASE | PRICE/EACH | | FOIL / PAD PRINT F and PP: inside and top lid 100+ 35¢ each 1000+ 32¢ each 2500+ 26¢ each |
|----------|---------------|------|------------|--------|---|
| | | | 100+ | 1000+ | |
| 31040315 | 4 x 3 x .625 | 100 | \$1.76 | \$1.34 | |

Pewter Gift Card Box with Ribbon

Estimated lead time: 2 - 3 weeks for printed items from approved art.
Minimum order is one case pack.

| CODE | SIZE (inches) | CASE | PRICE/EACH | | FOIL / PAD PRINT F and PP: inside and top lid 50+ 35¢ each 1000+ 32¢ each 2500+ 26¢ each |
|----------|-------------------|------|------------|--------|--|
| | | | 50+ | 1000+ | |
| 31040742 | 7.5 x 4.25 x .625 | 50 | \$2.42 | \$2.28 | |



Gift Cards
Not Included.



Sold separately.

Gift Certificate and Box

Estimated lead time: 2 - 3 weeks for printed items from approved art.

| CODE | SIZE (inches) | CASE PACK | PRICE/EACH 100+ |
|-----------|---|-----------|-----------------|
| 09221002B | White Gift Certificate Box Only | 100 | \$2.56 |
| 18197 | English Gift Certificate 6.375 x 3.125" folded | 100 | \$0.81 |
| 18196 | French Gift Certificate 6.375 x 3.125" folded | 100 | \$0.81 |

FOIL / PAD PRINT
F and PP: certificate and top lid
100+ 35¢ each
1000+ 32¢ each
2500+ 26¢ each
Minimum order is one case pack.

Gift certificates are pre-numbered.



SPECIAL ORDER

Gift Card Boxes



15 - Black

08 - Pewter

00 - White

Gift Cards
Not Included.

00 - White

08 - Silver

73 - Gold



Estimated lead time: 3 weeks for unprinted items and 4 weeks for printed items from approved art.

Monte Carlo Gift Card Box

People love gift cards, this box takes the presentation to a new level.

- Smooth paper hinged box with magnetic closure
- Removable insert to hold card, just slide in place for secure hold
- Try 15-black with our clear black gloss print GL2

| CODE | SIZE (inches) | CASE | PRICE/EACH 100+ |
|-----------|---------------|------|-----------------|
| 310239 __ | 5.125 x 4 x 1 | 100 | \$3.64 |

FOIL / PAD PRINT
F: inside lid only / PP: inside and outside lid
100+ 35¢ each
1000+ 32¢ each
2500+ 26¢ each
Estimated lead time: 3 weeks for unprinted items and 4 weeks for printed items from approved art.

Gift Card Nest Box

- White paperboard platforms
- Interior has same paper for lids and bases

| CODE | SIZE (inches) | CASE | PRICE/EACH 100+ |
|-----------|------------------|------|-----------------|
| 313230 __ | 3.5 x 2.25 x .75 | 100 | \$2.03 |

Estimated lead time: 3 weeks for unprinted items and 4 weeks for printed items from approved art.

Gift Certificate Box

| CODE | SIZE (inches) | CASE PACK | PRICE/EACH 100+ |
|-----------|--|-----------|-----------------|
| 0922100_B | Gift Certificate Box Only see colour options 6.625 x 3.25 x .5 | 100 | \$2.56 |

Gift Certificate Box Colour:



Minimum order is one case pack.

FOIL / PAD PRINT
F and PP: top lid only
100+ 35¢ each
1000+ 32¢ each
2500+ 26¢ each

IN STOCK Finishing Touches

Available to finish the look of your gift certificate/card.

Stretch Loops (100 pack min.)

| | | |
|--------------|--------|-----------|
| 09500607 6" | Gold | \$0.16/ea |
| 09500608 6" | Silver | \$0.16/ea |
| 09501007 10" | Gold | \$0.18/ea |
| 09501008 10" | Silver | \$0.18/ea |



Dress it up with printed ribbon!
See page 114.



IN STOCK

Pouches

Microfiber Pouches

• Minimum case pack 100

| CODE | COLOUR | SIZE (inches) | PRICE /EACH | |
|----------|--------|---------------|-------------|--------|
| | | | 100+ | 500+ |
| 09040315 | Black | 4 x 3 | \$1.26 | \$1.11 |
| 09050415 | Black | 5-1/2 x 4 | \$1.89 | \$1.60 |
| 09040311 | Blue | 4 x 3 | \$1.26 | \$1.11 |
| 09050411 | Blue | 5-1/2 x 4 | \$1.89 | \$1.60 |



IN STOCK

Pouches

Geo Series

• Minimum case pack 12.

Estimated lead time: 2 - 3 weeks for printed items from approved art.



| CODE | TYPE | SIZE (in.) | PRICE /EACH | |
|-------------|---------------------------|------------|-------------|--------|
| | | | 12+ | 144+ |
| A 09030415B | Geo Pouch with Black Box | 3 x 4 | \$2.77 | \$2.35 |
| B 09030456P | Geo Pouch with Purple Box | 3 x 4 | \$2.77 | \$2.35 |
| C 09030427T | Geo Pouch with Bronze Box | 3 x 4 | \$2.77 | \$2.35 |

FOIL / PAD PRINT
F and PP: pouch and packer lid
12+ 35¢ each
144+ 32¢ each
504+ 26¢ each

Damask Pouches



Zippered section

Envelope Pouches with snap closure



Available in black. Packaged in a 2-piece, pearled, dark grey outer box.



Microfiber Bell Pouches +

• Minimum case pack of 12



White Leatherette Pouches



Gold Metallic Pouches



Velveteen Pouches



- Black - 615
- Royal Blue - 611
- Brown - 612
- Green - 667
- Burgundy - 666

**See chart for 2-piece SPECIAL ORDER outer box for the Velveteen pouches.



Wedding Pouches +

White satin pouch with a white 2-piece outer box.

• Minimum case pack 12



SPECIAL ORDER

Natural Jute and Natural Cotton Pouches

• Minimum 100 per size.

Estimated lead time: 6 weeks for printed items from approved art.



Natural Cotton - FOIL PRINT ONLY

| CODE | SIZE (in.) | PRICE /EACH | |
|------------|------------|-------------|--------|
| | | 100+ | 1000+ |
| 09030400NC | 3 x 4 | \$0.60 | \$0.50 |
| 09050600NC | 5 x 6 | \$0.86 | \$0.70 |
| 09061000NC | 6 x 10 | \$1.29 | \$1.05 |
| 09081200NC | 8 x 12 | \$1.73 | \$1.42 |

FOIL PRINT
100+ 32¢ each
1000+ 29¢ each
2500+ 24¢ each

Natural Jute - NO PRINT

| CODE | SIZE (in.) | PRICE /EACH | |
|------------|------------|-------------|--------|
| | | 100+ | 1000+ |
| 09050500NJ | 3 x 5 1/2 | \$1.12 | \$0.92 |
| 09050600NJ | 5 x 6 | \$1.33 | \$1.09 |
| 09061000NJ | 6 x 10 | \$1.77 | \$1.45 |

| CODE | TYPE | SIZE (in.) | CASE PACK | PRICE/EACH | |
|-------------|-------------------------------|----------------|-----------|------------|--------|
| | | | | 100+ | 1000+ |
| A 09040515D | Large Damask Pouch | 5.5 x 4 | 100 | \$2.87 | \$2.35 |
| B 09030315D | Small Damask Pouch | 3 x 3 | 100 | \$1.84 | \$1.66 |
| C 09304715 | Large Envelope Pouch | 3 x 4 | 100 | \$2.80 | \$2.64 |
| D 09203715 | Small Envelope Pouch | 2.375 x 2.75 | 100 | \$2.16 | \$1.98 |
| E 09525115B | Large Microfiber Bell Pouch | 4.375 x 5.3751 | 12 | \$1.46 | \$1.25 |
| F 09324115B | Small Microfiber Bell Pouch | 3.25 x 4.5 | 12 | \$1.17 | \$1.01 |
| G 09314700 | Large White Leatherette Pouch | 3 x 4 | 100 | \$1.00 | \$0.88 |
| H 09203700 | Small White Leatherette Pouch | 2.75 x 3.25 | 100 | \$0.71 | \$0.64 |
| I 09314807 | Gold Metallic Pouch | 3 x 4 | 100 | \$0.77 | \$0.61 |
| J 09405 ___ | *Velveteen Pouches | 4 x 5.5 | 100 | \$0.97 | \$0.65 |
| K 09314 ___ | *Velveteen Pouches | 3 x 4 | 100 | \$0.80 | \$0.54 |
| 31314003 | White 2-piece outer box** | 3.25 x 4.25 | 100 | \$1.34 | \$1.22 |
| 31065000K | White 2-piece outer box | 6 x 5 x 1 | 50 | \$2.27 | \$2.06 |
| L 37501006 | White Wedding Pouches | 1.875 x 2.5 | 12 | \$1.08 | \$0.87 |

* See photo for colour code

Economical packaging for inexpensive items or repairs.

Estimated lead time: 2 - 3 weeks for printed items from approved art.

FOIL / PAD PRINT
100+ 35¢ each
1000+ 32¢ each
2500+ 26¢ each

+ Bell Pouches and Wedding Pouch minimums:

FOIL / PAD PRINT
12+ 35¢ each
144+ 32¢ each
504+ 26¢ each

Organza Colours (Not exactly as shown.)

| | | |
|--------------------|-------------------|--------------------|
| Black - 030 | Silver - 012 | White - 029 |
| Hunter - 589 | Navy - 370 | Smoke Blue - 337 |
| Lt. Blue - 305 | Burgundy - 276 | Ultra Violet - 467 |
| Purple - 465 | Lavender - 430 | Copper - 073 |
| Orange - 750 | Olive - 563 | Mint - 530 |
| Red - 250 | Pink - 115 | Gold - 690 |
| Baby Maize - 617 | Ivory - 810 | Mauve - 161 |
| Pastel Green - 513 | Fruit Punch - 155 | Yellow - 645 |
| Turquoise - 340 | Royal - 350 | Fuchsia - 187 |

A is only available in Silver, White, Pink, Lavender, Gold and Ivory.

F not available in Fruit Punch, Orange, Royal, Turquoise and Yellow.

G is only available in Silver, White, Pink, Red, Burgundy, Lt. Blue, Royal, Lavender, Mint, Olive, Gold and Ivory.

| CODE | SIZE (inches) | PRICE /EACH | |
|-------------|---------------------|-------------|--------|
| | | 100+ | 1000+ |
| A 09905 ___ | 2 x 2.5 | \$0.43 | \$0.36 |
| B 09910 ___ | 3 x 4 | \$0.46 | \$0.37 |
| C 09915 ___ | 4 x 5.5 | \$0.60 | \$0.48 |
| D 09920 ___ | 5 x 6.5 | \$0.69 | \$0.56 |
| E 09925 ___ | 5.5 x 9 | \$1.02 | \$0.83 |
| F 09930 ___ | 6 x 14 | \$1.19 | \$0.97 |
| G 09950 ___ | 22 x 25 (not shown) | \$3.94 | \$3.15 |

Minimum 100 per size/colour.

Estimated lead time: 6 weeks for printed items from approved art. Foil printed to be determined.

FOIL PRINT - TBD
100+ 35¢ each
1000+ 32¢ each
2500+ 26¢ each



Organza

IN STOCK

Jewellery Care

Available for immediate shipment.

New

We care about your jewellery as much as you do!

We care about your jewellery, that's why we use better ingredients, better packaging, and you get better performance to keep you sparkling brighter all day long. Use Lavish everyday to safely and conveniently make your jewellery sparkle and shine more than it ever has.



SPECIAL ORDER

Estimated lead time: 3-4 weeks for printed items from approved art.

Jewellery Care

New

Customize with your store brand!

Quality professional jewellery care, such as LAVISH, starts as an add-on sale or complimentary gift with purchase and keeps customers coming back for more. Every time customers clean their jewellery with customized LAVISH jewellery care, they will think of your store.



Lavish Jewellery Bath

Jewellery bath includes 1 pod of our jewellery cleaner concentrate. An effective jewellery cleaner that can be used on all jewellery from Pearls and Opals to Diamonds without the risk of damage.

8 fl. oz. (236 ml)
04530000 \$5.93 ea
50 per case pack



Lavish Polishing Cloth

Gold, Silver, Platinum oh my!

Bring back the shine of all your metals with the Lavish signature polishing cloth. Our polishing cloth is infused with a gentle and effective polishing compound that will bring back the luster and shine to your jewellery. Great for use on gold, silver, platinum, and other precious metals.

Note: To avoid the possibility of small scratches, care should be taken to avoid contact with stones other than diamonds. 8 fl. oz. (236 ml)
6" x 8" - Slate Grey with Vellum Envelope
04540000 \$5.21 ea
50 per case pack



Handling Gloves

White microfiber. One size fits all
The natural oils in our skin can often leave displeasing marks on jewellery. Our microfiber, lint-free gloves are ideal for handling and protecting your most precious inventory.

05000296 \$2.95 /pair
Minimum order - 6 pairs

Full Colour Digital Printed Labels

Create your own full colour look or our artist can create a design for your approval. Estimated lead time: 3 - 4 weeks for custom printed items from approved art.



Lavish Jewellery Bath

8 fl. oz. (236 ml)
04530000C \$5.93 ea
Minimum order 150 jars



Lavish Foam

1.69 fl. oz. (50 ml) 2.5 fl. oz. (75 ml)
04510050C \$6.97 ea 04510075C \$9.13 ea
Minimum order 96 bottles per size



Lavish Polishing Cloth

6" x 8" - Slate Grey with Vellum Envelope
04540000C \$5.21 ea

Screen print colours: Black, Silver, Gold or White
Minimum order 200 cloths



Lavish Click Clean Pen

.108 fl. oz. (3.2 ml)
04520000C \$7.40 ea
Minimum order 100 pens



Diamond & Gem Cloths

Microfiber Cloth removes small dust, oily film, fingerprints and other residue from fine jewellery. Chemical Free. Lint Free. AVAILABLE IN LIGHT BLUE ONLY. Estimated lead time: 4 - 6 weeks for custom printed cloths from approved art.

8 x 8" Blue Cloth 04780800C \$4.89 ea
Minimum order is 144 cloths.



All print orders subject to set-up charges. Applicable artwork, and plate charges may apply. See page 122.

All print orders subject to set-up charges. Applicable artwork, and plate charges may apply. See page 122.

IN STOCK

Jewellery Care

Estimated lead time: 2 - 3 weeks for printed items from approved art.

 **NO PLATE CHARGES!**

Repair Envelopes

| CODE | DESCRIPTION | SIZE (in) | 1000 | 3000 | 5000 | 10000 |
|-------------|---------------------------------|-------------|--------|--------|--------|--------|
| A 09850000 | 2-Part NCR | 4.25 x 9 | \$0.41 | \$0.37 | \$0.32 | \$0.26 |
| B 09845200 | Plain-no perf., text or numbers | 3.5 x 6.125 | \$0.15 | \$0.14 | \$0.12 | \$0.10 |
| C 09845300 | Double Perforated | 3.5 x 6.125 | \$0.22 | \$0.19 | \$0.16 | \$0.14 |
| D 09845400 | Single Perforated | 3.5 x 6.125 | \$0.23 | \$0.20 | \$0.17 | \$0.15 |
| E 09850000E | 2-part NCR - NO PRINT | 4.25 x 9 | \$0.18 | \$0.15 | \$0.13 | \$0.11 |

• Prices include one colour printing. A second colour is \$ 0.029/each.
Minimum 1000 per style. Printing colours: Black, Red, Green and Blue



Please allow 2 - 3 weeks for printing.
\$37 set-up charge applies.

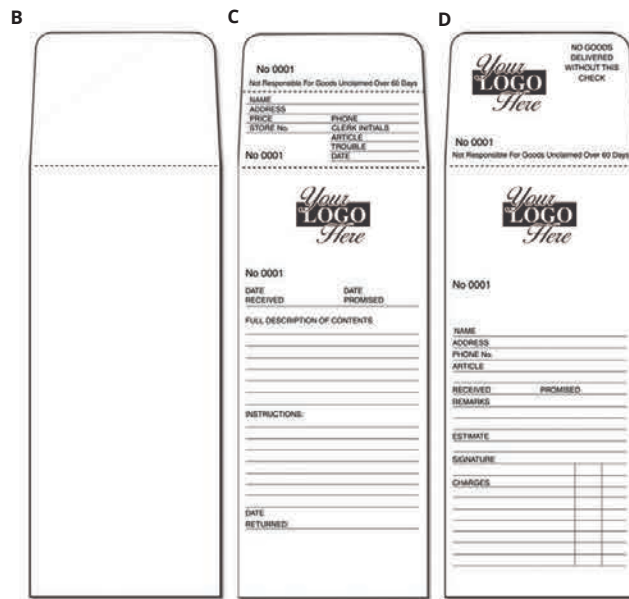

Tags and Miscellaneous Accessories

| CODE | DESCRIPTION | PACK MIN. | PRICE |
|------------|-----------------------------------|-----------|----------|
| E 08270207 | Plastic Ring Tags - Gold | Box/1000 | \$123.83 |
| F 08270208 | Plastic Ring Tags - Silver | Box/1000 | \$123.83 |
| G 08090707 | Plastic With String Tags - Gold | Box/1000 | \$123.83 |
| H 08090708 | Plastic With String Tags - Silver | Box/1000 | \$123.83 |
| I 08810800 | Super Mylar Ring Tags - Wide | Box/1000 | \$48.78 |
| J 08810700 | Super Mylar Ring tags - Narrow | Box/1000 | \$32.52 |
| 08833000 | Fine Pen Marker (not shown) | 1 | \$13.76 |



Available for immediate shipping for above items.

All print orders subject to set-up charges. Applicable artwork, and plate charges may apply. See page 122.

JEWELLERY DISPLAY



CREATE YOUR OWN LOOK

Step 1: Choose your platforms profile.
These can be made in any size.

REVEAL
Shown in
Novasuede



WHISPER
Shown in
Novasuede

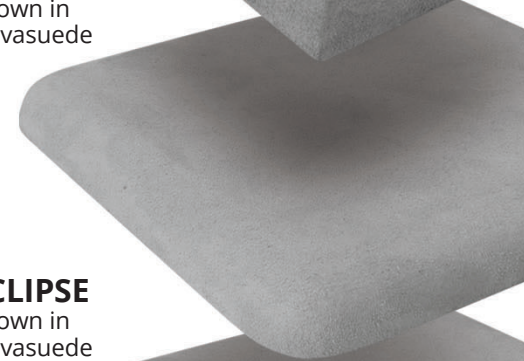

ECLIPSE
Shown in
Novasuede

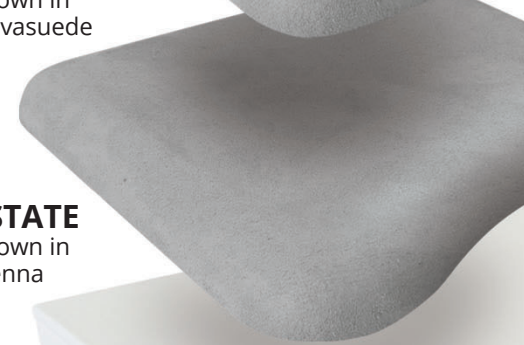

ESTATE
Shown in
Vienna



VANTAGE
Shown in
Vienna

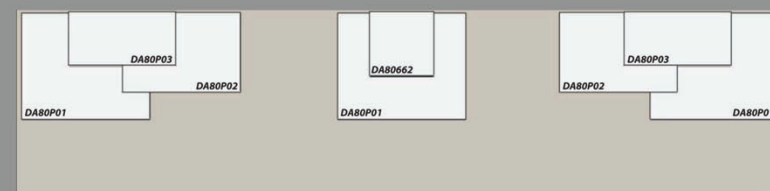
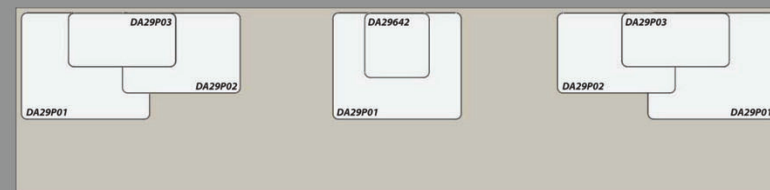
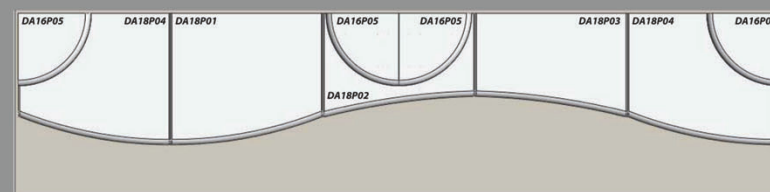
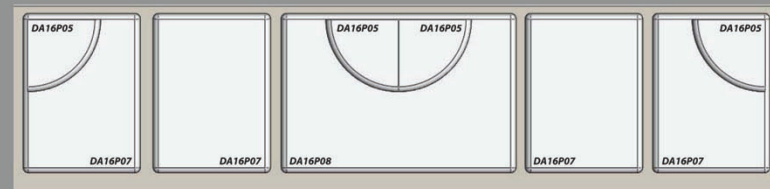
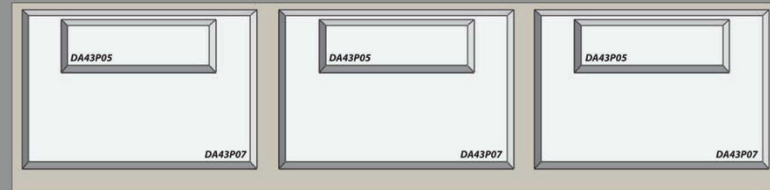

CREATE YOUR OWN LOOK

Step 2: Choose your elements.
Options: magnetics or hide a tag.

ELEMENT AND SHOWCASE PLATFORM STYLES

Call our experts for assistance.

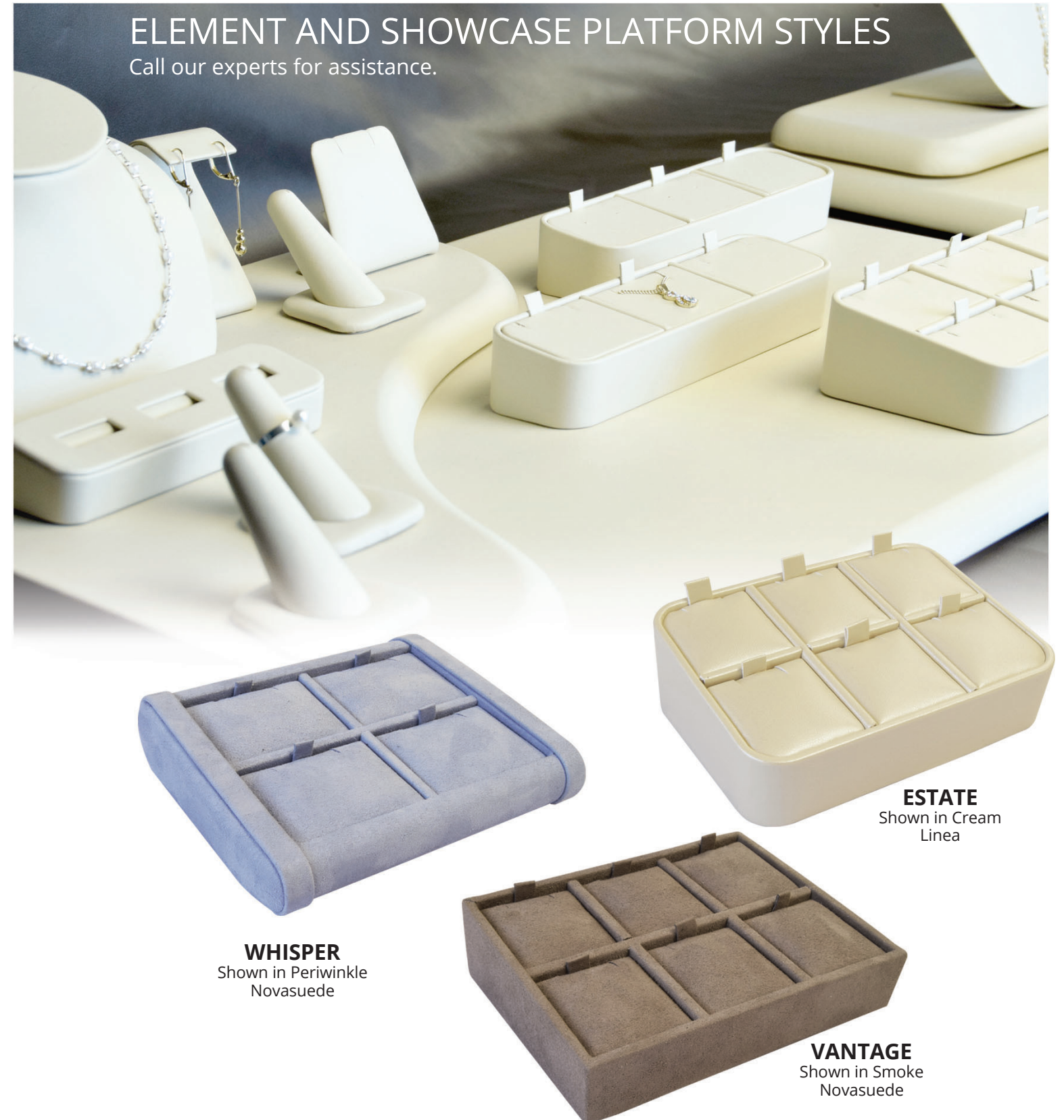

WHISPER
Shown in Periwinkle
Novasuede

ESTATE
Shown in Cream
Linea

VANTAGE
Shown in Smoke
Novasuede

CREATE YOUR OWN LOOK

FABRICS & COLOUR CHOICES

CALL OUR EXPERTS FOR ASSISTANCE.

Step 3: Choose your fabric colour and style. Options: metal or wood details.

Fabric for Floorboards - Minimum order of 2 yards x 54" wide Cut Yardage Pricing

| | | | |
|-----|----------|------------|---------------|
| 54" | Vienna | FIF1007936 | \$61.00/yard |
| 54" | Linea | FIF1037700 | \$71.00/yard |
| 49" | Charisma | FIF1037722 | \$81.00/yard |
| 54" | Elite | FIF1037723 | \$81.00/yard |
| 54" | Nova | FIF1037724 | \$132.00/yard |

Cutting Charge:
\$70.00 for any order
under 10 yards.

Lead times 2 - 3 weeks.

CREATE YOUR OWN LOOK

JEWELLERY DISPLAY

JEWELLERY DISPLAY



Elements shown
in Black Vienna
Leatherette

Vienna Leatherette - Group A

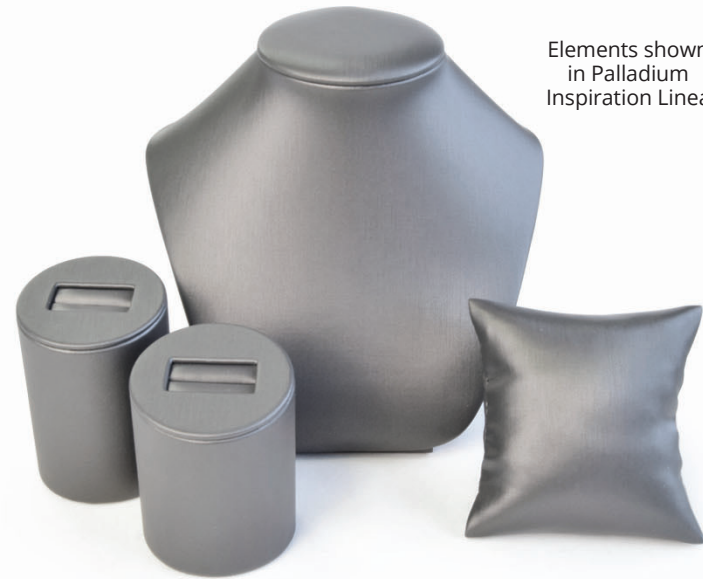

Elements shown
in Palladium
Inspiration Linea

Inspirations Linea - Group B

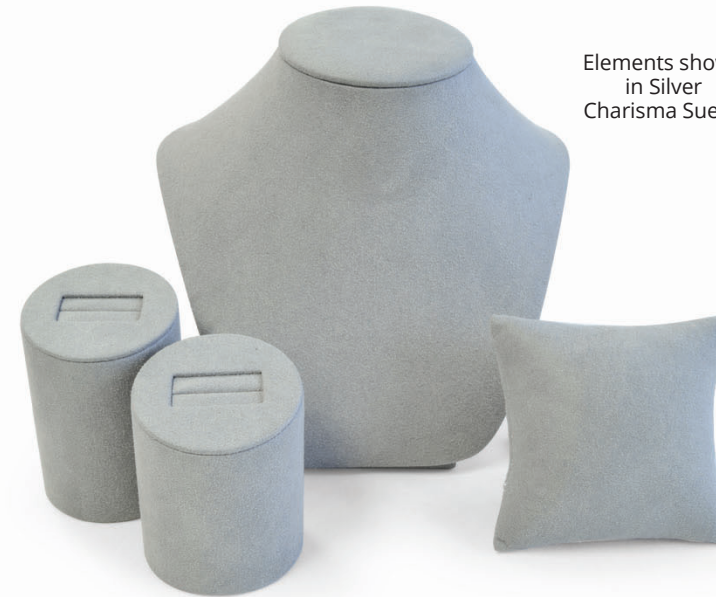

Elements shown
in Silver
Charisma Suede

Charisma Suede - Group B



Elements shown
in Gainsborough
Novasuede

Novasuede - Group C



IN STOCK

All our in stock displays are covered in Vienna Chalk fabric.

Ring Showcase Displays

Available for immediate shipment.

Save 25% when you buy \$500 or more!

JEWELLERY DISPLAY

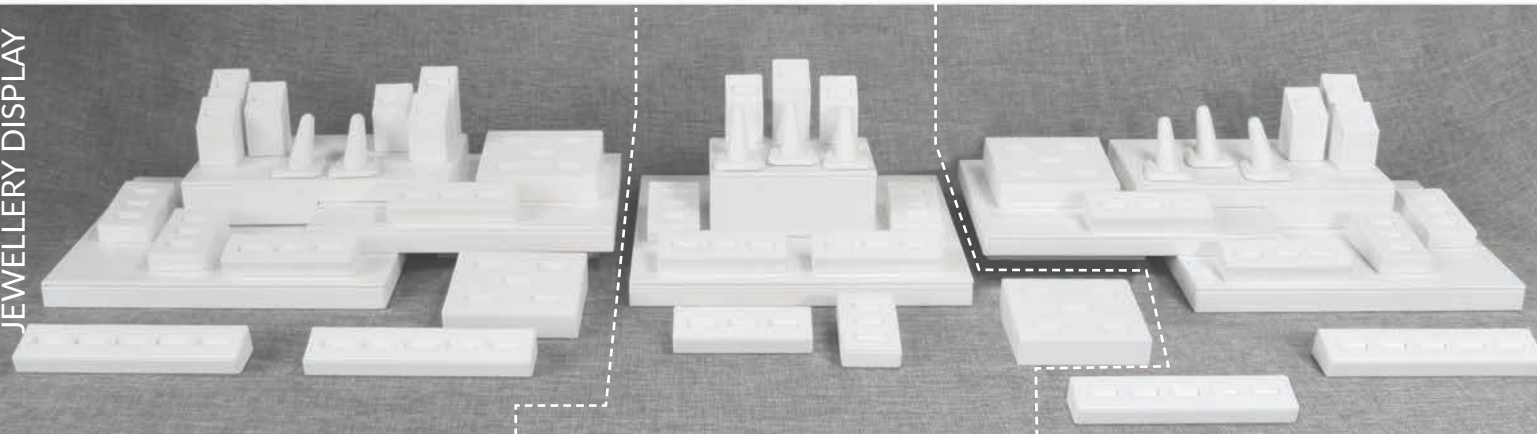

Section 1

16 sku capacity - 40 Rings

\$277.08*

*Platforms not included

Section 2

12 sku capacity - 29 Rings

\$240.14*

*Platforms not included

Section 3

14 sku capacity - 33 Rings

\$218.52*

*Platforms not included

Complete 6 foot - 102 ring element display - \$735.74

Buy \$500+ \$551.80

Add all platforms as shown - \$440.37

Buy \$500+ \$330.28

All our in stock displays are covered in Vienna Chalk fabric.

Available for immediate shipment.

IN STOCK

Pendant/Earring and Mix Showcase Displays

Save 25% when you buy \$500 or more!

JEWELLERY DISPLAY

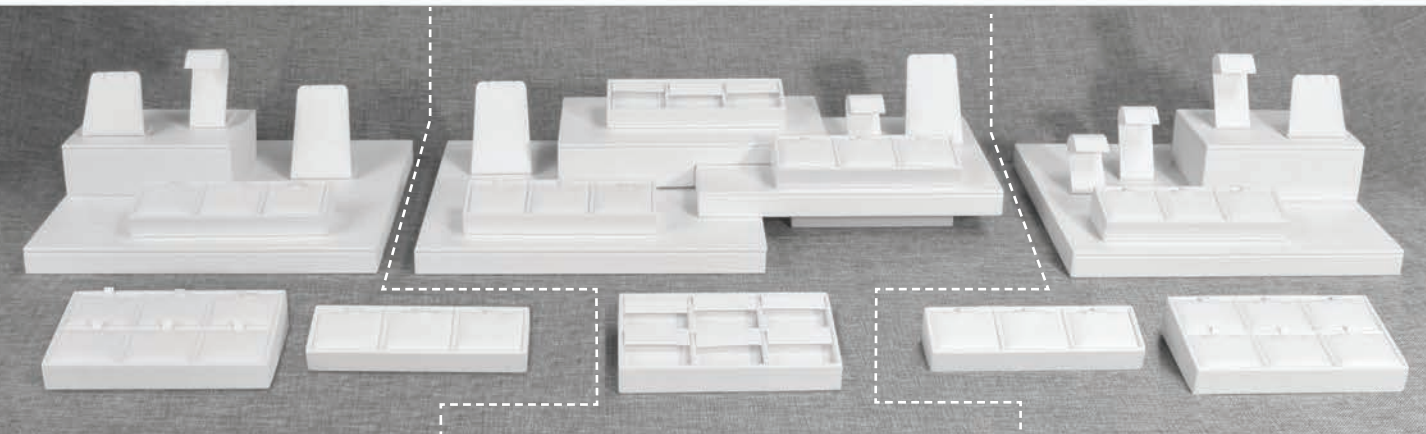

Section 1

15 sku capacity - 5 Pendants, 10 Earrings

\$136.68*

*Platforms not included

Section 2

18 sku capacity - 5 Pendants, 13 Earrings

\$121.45*

*Platforms not included

Section 3

16 sku capacity - 13 Pendants, 3 Earrings

\$121.95*

*Platforms not included

Complete 5 foot - 49 pendant/earring element display - \$380.08

Buy \$500+ \$285.06

Add all platforms as shown - \$363.15

Buy \$500+ \$272.36

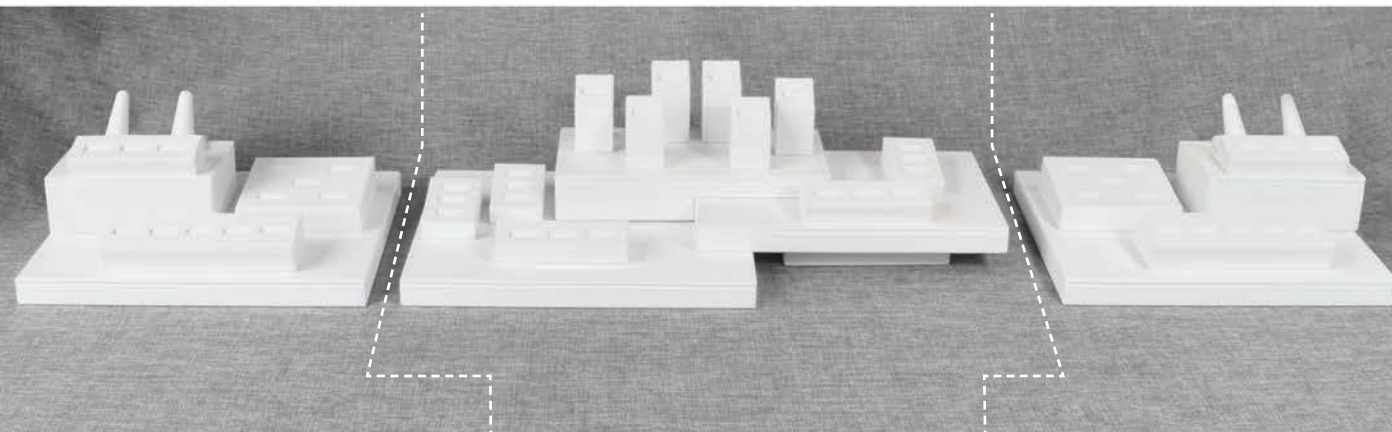

Section 1

5 sku capacity - 15 Rings

\$92.69*

*Platforms not included

Section 2

11 sku capacity - 21 Rings

\$150.12*

*Platforms not included

Section 3

5 sku capacity - 15 Rings

\$92.68*

*Platforms not included

Complete 5 foot - 51 ring element display - \$335.49

Buy \$500+ \$251.62

Add all platforms as shown - \$369.45

Buy \$500+ \$277.09

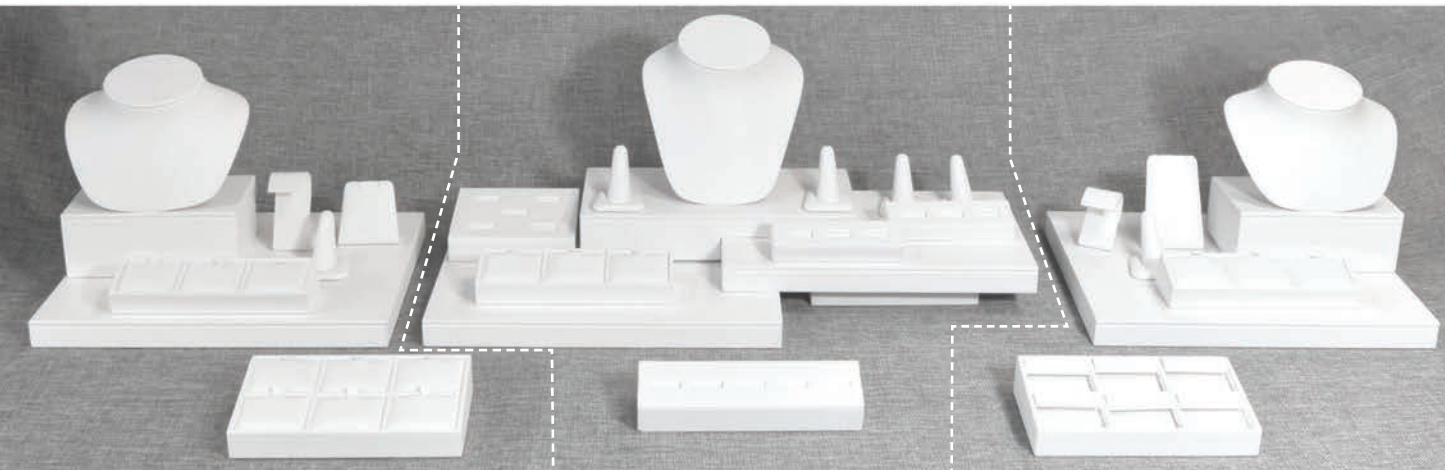

Section 1

13 sku capacity - 1 Ring, 8 Pendants, 4 Earrings

\$138.55*

*Platforms not included

Section 2

24 sku capacity - 20 Rings, 4 Pendants

\$209.66*

*Platforms not included

Section 3

13 sku capacity - 1 Ring, 2 Pendants, 10 Earrings

\$143.64*

*Platforms not included

Complete 5 foot - 50 mix element display - \$458.79

Buy \$500+ \$344.08

Add all platforms as shown - \$360.29

Buy \$500+ \$270.22





IN STOCK

All our in stock displays are covered in Vienna Chalk fabric.

Platforms and Risers

Available for immediate shipment.

Save 25% when you buy \$500 or more!

| Item | Part No. / Description | Price/ea. | Item | Part No. / Description | Price/ea. |
|--|--|----------------|--|---|----------------|
|  | DA80P01-SC Platform 12 x 10 x .875" | \$61.00 |  | DA80P03-SC Platform 10 x 5 x 1.75" | \$52.94 |
| | BUY \$500+ | \$45.75 | | BUY \$500+ | \$39.71 |
|  | DA80P02-SC Platform 11 x 7.5 x 1.875" | \$60.69 |  | DA80332-SC Riser 3 x 3 x 2" | \$15.24 |
| | BUY \$500+ | \$45.52 | | BUY \$500+ | \$11.43 |
|  | DA80662-SC Riser 6 x 6 x 2" | \$36.41 | | | |
| | BUY \$500+ | \$27.31 | | | |

* Display case floorboards are not included in the price. Material for covering your own floorboards is available and is priced by the yard. See page 65.

Platform layout suggestions



4 foot case - 26" wide, 10" deep



5 foot case - 44" wide, 10" deep



6 foot case - 52" wide, 10" deep • 19" left, 12" center and 19" right

Total price does not include applicable taxes. In stock displays and platforms are only available in VANTAGE style in Vienna fabric option.









IN STOCK

Neck Forms

All our in stock displays are covered in Vienna Chalk fabric.



Save 25% when you buy \$500 or more!

| Item | Part No. / Description | Price/ea. | Item | Part No. / Description | Price/ea. |
|---|--|----------------|---|---|----------------|
|  | DANF1021-SC Neck form 7.125 x 2.25 x 8.625" | \$46.73 |  | DANF1010-SC Neck form 7.75 x 8.5 x 11" | \$81.82 |
| | BUY \$500+ | \$35.05 | | BUY \$500+ | \$61.37 |
|  | DANF1026-SC Neck form 6 1/2 x 4 1/2 x 4" | \$34.93 |  | DANF1029-SC Neck form 7 x 6 1/2 x 7 1/4" | \$59.45 |
| | BUY \$500+ | \$26.20 | | BUY \$500+ | \$44.59 |
|  | DANF1028-SC Neck form 6 1/2 x 4 1/2 x 6" | \$47.15 |  | DANF2003-SC Neck form 3 x 2 1/2 x 3 1/2" | \$22.86 |
| | BUY \$500+ | \$35.36 | | BUY \$500+ | \$17.15 |
|  | DANF1027-SC Neck form 7 x 6 1/2 x 4 3/4" | \$62.45 |  | DANF1034-SC Neck form 6 3/4 x 6 x 7 5/8" | \$63.22 |
| | BUY \$500+ | \$46.84 | | BUY \$500+ | \$47.42 |

JEWELLERY DISPLAY

JEWELLERY DISPLAY

IN STOCK

All our in stock displays are covered in Vienna Chalk fabric.

Ring Stands and Trays Available for immediate shipment.

Save 25% when you buy \$500 or more!

JEWELLERY DISPLAY

| Item | Part No. / Description | Price/ea. | Item | Part No. / Description | Price/ea. |
|---|--|--------------------------------------|--|--|--------------------------------------|
|  | DA80058UR-SC Ring stand 1 5/8 x 1 1/2 x 2 1/8" | \$12.59 BUY \$500+ \$9.44 |  | DA80070S-SC Ring stand set | \$56.07 BUY \$500+ \$42.05 |
|  | DA80059UR-SC Ring stand 1 5/8 x 1 1/2 x 2 1/2" | \$12.74 BUY \$500+ \$9.56 | <i>Includes: 1-DA80060UR 2-DA80059UR 2-DA80058UR</i> | | |
|  | DA80060UR-SC Ring stand 1 5/8 x 1 1/2 x 2 3/4" | \$12.87 BUY \$500+ \$9.65 |  | DA8004RV-SC 4 ring vertical bar 1 3/4 x 4 x 1" | \$21.33 BUY \$500+ \$16.00 |
|  | DA28A01UR-SC Universal ring tray 2 3/8 x 2 1/4 x 1 1/2" | \$11.57 BUY \$500+ \$8.68 |  | DA8005RH-SC 5 ring horizontal bar 7 1/4 x 1 5/8 x 1" | \$25.91 BUY \$500+ \$19.43 |
|  | DA8002RV-SC 2 ring vertical bar 1 3/4 x 2 1/8 x 1" | \$15.24 BUY \$500+ \$11.43 |  | DA28C05UR-SC 5 universal ring tray 6 3/4 x 2 1/4 x 1 1/2" | \$22.86 BUY \$500+ \$17.15 |
|  | DA8002RH-SC 2 ring horizontal bar 3 1/4 x 1 5/8 x 1" | \$15.24 BUY \$500+ \$11.43 |  | DA28D05UR-SC 5 universal ring tray 4 5/8 x 4 x 1 1/2" | \$30.48 BUY \$500+ \$22.86 |
|  | DA8003RV-SC 3 ring vertical bar 1 3/4 x 3 x 1" | \$17.78 BUY \$500+ \$13.33 |  | DA28E05RD-SC 5 ring duo tray 6 3/4 x 4 x 1 1/2" | \$36.08 BUY \$500+ \$27.06 |
|  | DA8003RH-SC 3 ring horizontal bar 4 1/2 x 1 5/8 x 1" | \$19.08 BUY \$500+ \$14.31 |  | DA28E07UR-SC 7 ring tray 6 3/4 x 4 x 1 1/2" | \$35.57 BUY \$500+ \$26.68 |















All our in stock displays are covered in Vienna Chalk fabric.

IN STOCK

Ring Stands, Pendant Stands and Trays Available for immediate shipment.

Save 25% when you buy \$500 or more!

JEWELLERY DISPLAY

| Item | Part No. / Description | Price/ea. | Item | Part No. / Description | Price/ea. |
|---|--|--------------------------------------|---|---|--------------------------------------|
|  | DA28D07UR-SC 7 universal ring tray 4 5/8 x 4 x 1 1/2" | \$32.52 BUY \$500+ \$24.39 |  | DAF400T-SC Ring feature stand 2 5/8 x 2 1/4 x 2.625" | \$25.40 BUY \$500+ \$19.05 |
|  | DA28E08UR-SC 8 ring tray 6 3/4 x 4 x 1 1/2" | \$34.55 BUY \$500+ \$25.91 |  | DAF400S-SC Ring feature stand 2 5/8 x 2 1/4 x 2.25" | \$24.90 BUY \$500+ \$18.68 |
|  | DA28D08UR-SC 8 universal ring tray 4 5/8 x 4 x 1 1/2" | \$32.23 BUY \$500+ \$24.17 |  | DARF110-SC Ring finger 2 7/8 x 2 5/8 x 1 7/8" | \$10.13 BUY \$500+ \$7.60 |
|  | DA28E11UR-SC 11 ring tray 6 3/4 x 4 x 1 1/2" | \$34.55 BUY \$500+ \$25.91 |  | DARD130-SC Ring disc min. order qty. of 12 1 1/4" Diameter | \$0.96 BUY \$500+ \$0.72 |
| Item | Part No. / Description | Price/ea. | Item | Part No. / Description | Price/ea. |
|  | DA350P-SC Pendant stand 2 3/8 x 1 1/2 x 3 1/2" | \$12.71 BUY \$500+ \$9.53 |  | DA225P-SC Pendant stand 2 3/8 x 2 1/4 x 2" | \$10.16 BUY \$500+ \$7.62 |
|  | DA345P-SC Pendant stand 3 x 2 x 4" | \$23.72 BUY \$500+ \$17.79 |  | DA234P-SC Pendant stand 2 1/2 x 2 x 3" | \$15.24 BUY \$500+ \$11.43 |
|  | DA28A01PD-SC Pendant tray 2 3/8 x 2 1/4 x 1 1/2" | \$13.22 BUY \$500+ \$9.92 |  | DA28C03PD-SC 3 pendant tray 6 3/4 x 2 1/4 x 1 1/2" | \$30.48 BUY \$500+ \$22.86 |
|  | DA28D04PD-SC 4 pendant tray 4 5/8 x 4 x 1 1/2" | \$40.14 BUY \$500+ \$30.11 |  | DA28D06PD-SC 6 pendant tray 4 5/8 x 4 x 1 1/2" | \$43.19 BUY \$500+ \$32.39 |
|  | DA28E06PD-SC 6 pendant tray 6 3/4 x 4 x 1 1/2" | \$43.19 BUY \$500+ \$32.39 |  | DA28E08PD-SC 8 pendant tray 6 3/4 x 4 x 1 1/2" | \$48.26 BUY \$500+ \$36.20 |

IN STOCK

Earring Stands and Trays

Save 25% when you buy \$500 or more!

All our in stock displays are covered in Vienna Chalk fabric.

Available for immediate shipment.

| Item | Part No. / Description | Price/ea. | Item | Part No. / Description | Price/ea. |
|---|--|--------------------------------------|--|---|--------------------------------------|
|  | DACES14-SC Earring tree stand 2 x 2 x 3" | \$14.02 BUY \$500+ \$10.52 |  | DACES13-SC Earring stand 1 1/4 x 1 7/8 x 2 3/4" | \$12.71 BUY \$500+ \$9.53 |
|  | DACES36-SC Earring stand 2 3/4 x 1 3/4 x 3 1/2" | \$14.02 BUY \$500+ \$10.52 |  | DASLD6-SC Earring sled 2 x 8 1/4 x 2" | \$15.24 BUY \$500+ \$11.43 |
|  | DA28A01FE-SC Flap earring tray 2 3/8 x 2 1/4 x 1 1/2" | \$15.24 BUY \$500+ \$11.43 |  | DA28A01PE-SC Pierced earring tray 2 3/8 x 2 1/4 x 1 1/2" | \$13.10 BUY \$500+ \$9.82 |
|  | DA28C03FE-SC 3 flap earring tray 6 3/4 x 2 1/4 x 1 1/2" | \$25.40 BUY \$500+ \$19.05 |  | DA28C03PE-SC 3 pierced tray 6 3/4 x 2 1/4 x 1 1/2" | \$27.44 BUY \$500+ \$20.58 |
|  | DA28D04FE-SC 4 flap earring tray 4 5/8 x 4 x 1 1/2" | \$40.14 BUY \$500+ \$30.11 |  | DA28D04PE-SC 4 pierced earring tray 4 5/8 x 4 x 1 1/2" | \$35.29 BUY \$500+ \$26.47 |
|  | DA28D06FE-SC 6 flap earring tray 4 5/8 x 4 x 1 1/2" | \$45.73 BUY \$500+ \$34.30 |  | DA28D06PE-SC 6 pierced earring tray 4 5/8 x 4 x 1 1/2" | \$50.53 BUY \$500+ \$37.90 |
|  | DA28E06FE-SC 6 flap earring tray 6 3/4 x 4 x 1 1/2" | \$45.73 BUY \$500+ \$34.30 |  | DA28E06PE-SC 6 pierced earring tray 6 3/4 x 4 x 1 1/2" | \$43.19 BUY \$500+ \$32.39 |
|  | DA28E08FE-SC 8 flap earring tray 6 3/4 x 4 x 1 1/2" | \$53.82 BUY \$500+ \$40.37 |  | DA28E08PE-SC 8 pierced earring tray 6 3/4 x 4 x 1 1/2" | \$48.27 BUY \$500+ \$36.20 |

All our in stock displays are covered in Vienna Chalk fabric.

IN STOCK

Earring, Bangle and Bracelet Stands, Chain Ramps, Counter Pads and Signage

Save 25% when you buy \$500 or more!

Available for immediate shipment.

| Item | Part No. / Description | Price/ea. | Item | Part No. / Description | Price/ea. |
|---|--|--|---|---|--------------------------------------|
|  | 05000755 Earring stand 7 x 4 1/2 x 1 3/4" | \$43.20 BUY \$500+ \$32.40 |  | DABS185-SC Bracelet sled 1 1/4 x 9 1/4 x 1 3/4" | \$13.00 BUY \$500+ \$9.75 |
|  | DASBS12-SC Bangle "T" bar 7 1/8 x 2 3/4 x 5 1/4" (dia. 1.625") | \$32.50 BUY \$500+ \$24.38 |  | DABS485-SC Bracelet sled 4 x 9 5/8 x 1 7/8" | \$21.68 BUY \$500+ \$16.26 |
|  | DAJP350V-SC Bracelet pillow w/stand 3 1/4 x 3 1/4 x 3 1/4" | \$12.68 BUY \$500+ \$9.29 |  | DADB425-SC Bracelet dome 4 1/8 x 5 1/8 x 2 1/2" | \$34.28 BUY \$500+ \$25.71 |
|  | DACHR16-SC Chain ramp / Rem. pad 10 1/4 x 16" chain pad 10 3/4 x 16 1/2 x 3 1/2" | \$122.34 BUY \$500+ \$91.76 |  | DA1081R-SC Pres. tray w/ring 10 1/2 x 8 5/8 x 1" | \$64.92 BUY \$500+ \$48.69 |
|  | 05000845-SC 16 Chain Tray Stackable 8 5/8 x 13 3/4 x 1 1/2" | \$155.36 BUY \$500+ \$116.52 |  | DAPCF5510-SC Counter pad plain 5 1/4 x 10 1/4 x 3/4" closed 10 3/4 x 10 1/4 x 3/8" open | \$42.48 BUY \$500+ \$31.86 |
|  | DACW884-SC Chain display wedge 8 x 8 x 3 3/4" | \$65.54 BUY \$500+ \$49.16 |  | DASB211 Sign stand 2 3/4 x 2 3/16 x 1 1/4" | \$16.75 BUY \$500+ \$12.56 |

IN STOCK

All our in stock displays are covered in Vienna Chalk fabric.

Specialty Items

Available for immediate shipment.

Save 25% when you buy \$500 or more!

JEWELLERY DISPLAY

| Item | Part No. / Description | Price/ea. | Item | Part No. / Description | Price/ea. |
|---|---|--------------------------------------|--|---|---------------------------------------|
|  | 05000300-SC Loose Diamond Arch 11.5" x 4" x 1.5" | \$75.95 BUY \$500+ \$56.92 |  | 05000301 Diamond Cup 1.125" diameter x .75" <small>Minimum order: 5 pcs</small> | \$14.11 BUY \$500+ \$10.58 |
|  | 05000299-SC Pearl Half Moon 8" x 8" x 3.25" | \$97.62 BUY \$500+ \$73.22 |  | 05000298-SC Wave Chain Ramp 10.125" x 9" x 2.625" | \$112.91 BUY \$500+ \$84.68 |
|  | <small>Sign size: 3.9375" x 2.375"</small> 05000300 Acrylic Sign 1.1875" x 4" x 2.75" | \$16.44 BUY \$500+ \$12.33 |  | 05000302 Bevelled Edge Mirror 8.5" x 8.25" x 5.5" | \$56.07 BUY \$500+ \$42.05 |
|  | 05000581-SC Pendant/earring tray with PVC signage 4.75" x 9.5" x 2" | \$54.80 BUY \$500+ \$41.10 |  | 36301103 Small Vision Box 2.68 x 2.68 x .75" | \$1.19 |
| | | |  | 36302103 Medium Vision Box 3.5 x 3.5 x .75" | \$1.59 |
| | | |  | 36303103 Large Vision Box 4.25 x 4.25 x .75" | \$1.99 |
| | | |  | 69300103 Base for Vision Box 2.24 x 2.24 x .62" Bag of 12 | \$0.99 |

JEWELLERY STORAGE by MELE AND Co



IN STOCK

Visit Mejewelrybox.com for order information.

Jewellery Storage by MELE AND Co



THE STOWAWAY LINE

- Vegan leather with coordinating zipper pull
- Cream anti-tarnish microsuede interior lining and metal zipper closure
- Custom leather option upon request
- Branded cleaning cloth and reusable dust bag included



The Essentials Colour Line

Black - 62 Buff - 44 Ecru - 10

| Code | Description | Size (inches) | Pack | Bento | Duo | Duo Mini | Stow and Go | Stow and Go Mini |
|-----------|------------------|------------------|------|-------|-----|----------|-------------|------------------|
| A 00629__ | Bento | 7 x 6.25 x 3.125 | 2 | ✓ | ✓ | — | — | — |
| B 00518__ | Duo | 6.875 x 3 x 5.25 | 2 | ✓ | ✓ | — | — | — |
| C 00513__ | Duo Mini | 5 x 3.75 x 2 | 4 | ✓ | ✓ | ✓ | — | — |
| D 00626__ | Stow and Go | 5 x 5 x 2.25 | 2 | ✓ | ✓ | — | ✓ | — |
| E 00618__ | Stow and Go Mini | 3.5 (D) x 1.625 | 4 | ✓ | ✓ | — | ✓ | ✓ |

Visit mejewelrybox.com for these plus other fashion forward, timeless classics and youthful collections!



Everly Kate Kelby Geneva Olympia Grant

BAGS

EUROTOTES, PAPER, POLY & REUSABLE



IN STOCK

Rope Handle Eurototes

BAGS



Vantage II Eurototes

- 150 gsm uncoated art paper
- 5 mm pp cord knotted handles
- Folded top turn and cardboard reinforced bottom
- Minimum order is 100 per colour per size

| CODE | SIZE (inches) | PRICE/EACH | | |
|--------------|--------------------|------------|--------|--------|
| | | 100+ | 500+ | 1000+ |
| A 230606 ___ | 6 x 3.5 x 6 x 3.5 | \$1.22 | \$1.12 | \$0.96 |
| B 231008 ___ | 10.5 x 5 x 8.5 x 5 | \$1.55 | \$1.39 | \$1.19 |



Eclipse and Geo Eurototes

- 150 gsm uncoated art paper
- 5 mm pp cord knotted handles
- Folded top turn and cardboard reinforced bottom
- Minimum order is 100 per colour per size

IN STOCK

Rope Handle Eurototes

BAGS



Laminated Eurotote with Rope Handle

- Matte lamination
- 157 gsm art paper
- 5 mm pp cord knotted polypropelene handle
- Folded top turn and cardboard reinforced bottom
- Minimum order is 100 per colour per size

| CODE | TYPE | SIZE (inches) | PRICE/EACH | | |
|--------------|------------|-------------------|------------|--------|--------|
| | | | 100+ | 500+ | 1000+ |
| A 239606 __ | Novelty | 6 x 3.5 x 6 x 3.5 | \$1.11 | \$0.99 | \$0.87 |
| B 239709 __ | Small gift | 9 x 3.5 x 7 x 3.5 | \$1.27 | \$1.08 | \$0.97 |
| C 239810 __ | Gift | 8 x 4 x 10 x 4 | \$1.39 | \$1.19 | \$1.08 |
| D 230908 __T | Trapezoid | 9/7 x 4 x 8.5 x 4 | \$1.64 | \$1.33 | \$1.28 |
| E 238116 __ | Fashion | 16 x 6 x 12 x 6 | \$2.57 | \$2.26 | \$1.96 |
| F 231011 __ | Watch | 10 x 5 x 11 x 5 | \$1.79 | \$1.47 | \$1.32 |

Estimated lead time: 2 - 3 weeks for printed items from approved art.

 **DIGITAL PRINT**
100+ \$2.45 each
1000+ \$2.25 each
300 bags minimum

 **FOIL PRINT**
100+ 35¢ each
1000+ 32¢ each
2500+ 26¢ each



| | 15-Black | 00-White | 07-Gold | 08-Silver | 42-Brown | 11-Blue | 10-Green |
|--|----------|----------|---------|-----------|----------|---------|----------|
| Novelty  | ✓ | ✓ | ✓ | ✓ | ✓ | ✓ | ✓ |
| Small Gift  | ✓ | ✓ | ✓ | ✓ | ✓ | ✓ | ✓ |
| Gift  | ✓ | ✓ | ✓ | ✓ | ✓ | ✓ | ✓ |
| Trapezoid  | ✓ | ✓ | ✓ | — | ✓ | — | — |
| Fashion  | ✓ | ✓ | ✓ | ✓ | ✓ | — | — |
| Watch  | ✓ | ✓ | ✓ | — | — | — | — |

All print orders subject to set-up charges. Applicable artwork, and plate charges may apply. See page 122.

All print orders subject to set-up charges. Applicable artwork, and plate charges may apply. See page 122.

IN STOCK

Luxury Grosgrain Handle Eurototes

BAGS



Luxury Grosgrain Handle Eurototes

- Gloss and matte lamination
- 157 gsm art paper
- 7/8" matching grosgrain, knotted handles
- Fold over top turn and cardboard reinforced bottom
- Minimum order is 100 per colour per size



| CODE | SIZE (inches) | CASE PACK | PRICE/EACH | | |
|----------|----------------------|-----------|------------|--------|--------|
| | | | 100+ | 500+ | 1000+ |
| A 230606 | 6 x 3 x 6 x 3 | 100 | \$1.12 | \$1.01 | \$0.87 |
| B 230810 | 8 x 4 x 10 x 4 | 100 | \$1.18 | \$1.06 | \$0.91 |
| C 231209 | 12.5 x 4.5 x 9 x 4.5 | 100 | \$1.42 | \$1.28 | \$1.10 |
| D 231612 | 16 x 6 x 12 x 6 | 100 | \$1.93 | \$1.74 | \$1.49 |
| E 232014 | 20 x 6 x 14 x 6 | 100 | \$2.16 | \$1.94 | \$1.67 |

* champagne and pewter not available in this size.

Available Colours



Estimated lead time: 2 - 3 weeks for printed items from approved art.

-  **DIGITAL PRINT**
100+ \$2.45 each
1000+ \$2.25 each
300 bags minimum
-  **FOIL PRINT**
100+ 35¢ each
1000+ 32¢ each
2500+ 26¢ each

IN STOCK

All Paper Eurototes

BAGS



All Paper Eurotote with Paper Rope Handle

- 100% recyclable
- 40% post-consumer waste
- 190 gsm uncoated paper
- 8 mm paper cord knotted handles
- Folded top turn and cardboard reinforced bottom
- Minimum order is 100 per colour per size

| CODE | SIZE (inches) | CASE PACK | PRICE/EACH | | |
|----------|-------------------|-----------|------------|--------|--------|
| | | | 100+ | 500+ | 1000+ |
| A 230606 | 6 x 3.5 x 6 x 3.5 | 100 | \$0.94 | \$0.83 | \$0.71 |
| B 230810 | 8 x 4 x 10 x 4 | 100 | \$1.03 | \$0.91 | \$0.77 |
| C 231013 | 10 x 5 x 13 x 5 | 100 | \$1.17 | \$1.03 | \$0.87 |
| D 231612 | 16 x 6 x 12 x 6 | 100 | \$1.77 | \$1.56 | \$1.33 |



Available Colours



Estimated lead time: 2 - 3 weeks for printed items from approved art.

-  **FOIL PRINT**
100+ 35¢ each
1000+ 32¢ each
2500+ 26¢ each

All print orders subject to set-up charges. Applicable artwork, and plate charges may apply. See page 122.

All print orders subject to set-up charges. Applicable artwork, and plate charges may apply. See page 122.

CREATE YOUR OWN LOOK

BAGS

Full Colour Paper Eurototes

Make a creative impression...
the combinations are endless!



Prices include up to 2 ink print colours:

| TYPE | SIZE (inches) |
|------------|------------------------|
| Novelty | 6 x 3.5 x 6 x 3.5 |
| Small Gift | 9 x 3.5 x 7 x 3.5 |
| Gift | 8 x 4 x 10 x 4 |
| Trapezoid | 9/7 x 4 x 8.5 x 4 |
| Wine | 3.375 x 3.5 x 13 x 3.5 |
| Fashion | 16 x 6 x 12 x 6 |
| Saville | 16 x 6 x 19 x 6 |

Prices include 4 colour process print:

| TYPE | SIZE (inches) |
|------------|------------------------|
| Novelty | 6 x 3.5 x 6 x 3.5 |
| Small Gift | 9 x 3.5 x 7 x 3.5 |
| Gift | 8 x 4 x 10 x 4 |
| Trapezoid | 9/7 x 4 x 8.5 x 4 |
| Wine | 3.375 x 3.5 x 13 x 3.5 |
| Fashion | 16 x 6 x 12 x 6 |
| Saville | 16 x 6 x 19 x 6 |

- Combination foil print and ink printing available.
- No charge for printing plates (proof charge applies)
- Substitute a satin ribbon handle for the standard rope
- Add metal grommets to your bag



Unique printing options available.
Double Stamping shown here.

Estimated lead time: 14 - 16 weeks for delivery from approved art.



Create Your Own Look:
Choose your bag style.
Send us your artwork.
For 100% full colour design, speak to your sales representative.

SPECIAL ORDER

5th Avenue Eurototes

BAGS



Thick Woven Handle Detail



5th Avenue Eurototes

- Embossed laminated finish with printed gloss coordinating colour interior
- 210 gsm
- Thick woven handles, top slit style
- W fold & removable bottom board
- Minimum order is 100 per colour per size

| CODE | SIZE (inches) | CASE PACK | PRICE/EACH | |
|--------------|----------------------|-----------|------------|--------|
| | | | 100+ | 1000+ |
| A 245820 __ | 8 x 3.5 x 6 x 3.5 | 100 | \$3.21 | \$3.04 |
| B 245821 __ | 12.5 x 4.5 x 9 x 4.5 | 100 | \$5.08 | \$4.82 |
| C 245822 ___ | 17 x 6 x 12.75 x 6 | 100 | \$6.94 | \$6.57 |

Estimated lead time: 3 - 5 weeks for printed items from approved art.

DIGITAL PRINT
100+ \$2.45 each
1000+ \$2.25 each
300 bags minimum

FOIL PRINT
100+ 35¢ each
1000+ 32¢ each
2500+ 26¢ each

Available Colours



All print orders subject to set-up charges. Applicable artwork, and plate charges may apply. See page 122.

SPECIAL ORDER

BAGS



12" Wide Gussets!



Manhattan Eurototes

- Uncoated paper with varnish finish*
- 180 gsm wood-free paper
- 5/8" poly/cotton twill knotted handle
- Folded top turn and cardboard reinforced bottom
- 200 gsm kraft paper 75% recycled** (colour chart reference)

| CODE | TYPE | CASE | PRICE/EACH | | |
|-------------|------------|------|------------|--------|--------|
| | | | 100+ | 500+ | 1000+ |
| A 245845 __ | Mini | 100 | \$1.25 | \$1.18 | \$1.12 |
| B 245841 __ | Petite | 100 | \$1.56 | \$1.48 | \$1.40 |
| C 245843 __ | Vanity | 100 | \$2.98 | \$1.87 | \$1.78 |
| D 245844 __ | Fashion | 100 | \$2.71 | \$2.57 | \$2.44 |
| E 245860 __ | X-Large | 50 | \$4.18 | \$3.96 | \$3.76 |
| F 245898 __ | Bottle Bag | 100 | \$1.71 | \$1.62 | \$1.54 |

| WIDE GUSSET EUROTOTES | | | PRICE/EACH | | |
|-----------------------|----------------|------|------------|--------|--------|
| CODE | TYPE | CASE | 100+ | 500+ | 1000+ |
| 24585615 | Medium - Black | 100 | \$5.57 | \$5.28 | \$5.02 |
| 24585715 | Large - Black | 100 | \$6.24 | \$5.91 | \$5.61 |
| 24585600 | Medium - White | 100 | \$5.57 | \$5.28 | \$5.02 |
| 24585700 | Large - White | 100 | \$6.24 | \$5.91 | \$5.61 |
| 24585675 | Medium - Kraft | 100 | \$5.57 | \$5.28 | \$5.02 |
| 24585775 | Large - Kraft | 100 | \$6.24 | \$5.91 | \$5.61 |

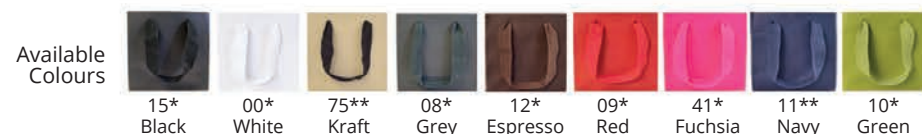

| Size | 15* Black | 00* White | 75** Kraft | 08* Grey | 12* Espresso | 09* Red | 41* Fuchsia | 11** Navy | 10* Green |
|--|-----------|-----------|------------|----------|--------------|---------|-------------|-----------|-----------|
| Mini 5 x 4 x 6 x 4 in | ✓ | ✓ | ✓ | ✓ | ✓ | ✓ | ✓ | ✓ | ✓ |
| Petite 8 x 4 x 10 x 4 in | ✓ | ✓ | ✓ | ✓ | ✓ | ✓ | ✓ | ✓ | ✓ |
| Vanity 10 x 5 x 13 x 5 in | ✓ | ✓ | ✓ | ✓ | ✓ | ✓ | ✓ | ✓ | ✓ |
| Fashion 16 x 6 x 12 x 6 in | ✓ | ✓ | ✓ | ✓ | ✓ | ✓ | ✓ | ✓ | ✓ |
| X-Large 20 x 6 x 14 x 6 in | ✓ | ✓ | ✓ | — | ✓ | — | — | — | — |
| Bottle 4.5 x 4.5 x 15 x 4.5 in | ✓ | ✓ | ✓ | — | ✓ | ✓ | — | — | — |
| Wide Gusset Medium 12.5 x 12 x 12 x 12 in. | ✓ | ✓ | ✓ | — | — | — | — | — | — |
| Wide Gusset Large 16 x 12 x 11 x 12 in. | ✓ | ✓ | ✓ | — | — | — | — | — | — |

Estimated lead time: 3 - 5 weeks for printed items from approved art.

DIGITAL PRINT
100+ \$2.45 each
1000+ \$2.25 each
300 bags minimum

FOIL PRINT
100+ 35¢ each
1000+ 32¢ each
2500+ 26¢ each

All print orders subject to set-up charges. Applicable artwork, and plate charges may apply. See page 122.

SPECIAL ORDER

BAGS

Paper Shoppers



New



Totally Trim Paper Shoppers

- Twist paper handle with bottom gusset
- 100% recyclable and biodegradable
- Minimum order per colour per size



| CODE | DESCRIPTION | SIZE (inches) | CASE PACK | PRICE/EACH | |
|-----------|-----------------------|-------------------|-----------|------------|--------|
| | | | | 300+ | 1000+ |
| 245111 __ | Small (90 gsm) | 11.8 x 9.8 x 3.9 | 300 | \$0.68 | \$0.62 |
| 245114 __ | Medium (100 gsm) | 14.2 x 10.6 x 3.9 | 250 | \$0.78 | \$0.70 |
| 245118 __ | Large (100 gsm) | 18.1 x 12.4 x 5.9 | 300 | \$0.95 | \$0.86 |
| 245119 __ | Extra Large (100 gsm) | 19.7 x 16.3 x 5.9 | 250 | \$1.10 | \$0.99 |



DIGITAL PRINT
100+ \$2.45 each
1000+ \$2.25 each
300 bags minimum



INK PRINT
100+ 34¢ each
1000+ 29¢ each
2500+ 24¢ each



FOIL PRINT
100+ 35¢ each
1000+ 32¢ each
2500+ 26¢ each

Estimated lead time: 2 - 3 weeks for printed items from approved art.



Tints and Pinstripe on Kraft

- Twist paper handle
- 120 gsm paper

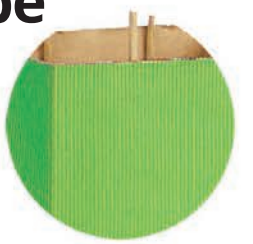

Pinstripe Detail

Tints on Kraft



Pinstripe on Kraft



| CODE | DESCRIPTION | SIZE (inches) | CASE PACK | PRICE/EACH |
|-------------|-------------|-----------------|-----------|------------|
| 230508 ____ | Prime | 5 x 3 x 8 x 3 | 250 | \$0.92 |
| 230809 ____ | Petite | 8 x 4.5 x 10 | 250 | \$0.95 |
| 231611 ____ | Fashion | 16 x 6 x 12 x 6 | 250 | \$1.50 |



DIGITAL PRINT
250+ \$2.45 each
1000+ \$2.25 each
300 bags minimum



INK PRINT
250+ 34¢ each
1000+ 29¢ each
2500+ 24¢ each



FOIL PRINT
250+ 35¢ each
1000+ 32¢ each
2500+ 26¢ each

Estimated lead time:
Approx. 6 weeks for No Print Bags.
Approx 8 - 10 weeks for Printed items from approved art.

All print orders subject to set-up charges. Applicable artwork, and plate charges may apply. See page 122.

CREATE YOUR OWN LOOK

Full Colour Simply Paper Shoppers

Make a creative impression...
the combinations are endless!



Create Your Own Look:
Choose your bag style.
Send us your artwork.
For 100% full colour
design, speak to your
sales representative.



96% Recycled Material

Simply Paper Shoppers

Kraft with paper twist handles, print 1 colour on 2 sides <25%

| TYPE | SIZE (inches) | CASE PACK |
|-----------|-------------------|-----------|
| Prime | 5.25 x 3.5 x 8.25 | 250 |
| Petite | 8 x 4 x 10 | 250 |
| Vanity | 10 x 5 x 13 | 250 |
| Celebrity | 13 x 6 x 15.5 | 250 |
| Fashion | 16 x 6 x 12 | 250 |
| Saville | 16 x 6 x 19 | 200 |
| Universal | 18 x 6 x 19 | 200 |
| Wine | 5.25 x 3.5 x 13 | 250 |

Any 2 Sizes
Minimum 3000
Special Pricing

White with paper twist handles, print 1 colour on 2 sides <25%

| TYPE | SIZE (inches) | CASE PACK |
|-----------|-------------------|-----------|
| Prime | 5.25 x 3.5 x 8.25 | 250 |
| Petite | 8 x 4 x 10 | 250 |
| Vanity | 10 x 5 x 13 | 250 |
| Celebrity | 13 x 6 x 15.5 | 250 |
| Fashion | 16 x 6 x 12 | 250 |
| Saville | 16 x 6 x 19 | 200 |
| Universal | 18 x 6 x 19 | 200 |
| Wine | 5.25 x 3.5 x 13 | 250 |

Any 2 Sizes
Minimum 3000
Special Pricing

• Minimum 5,000 per size or any
2 sizes, minimum 3000 per size

- Add a second colour
- Go 100% ink coverage
- Add a rope handle

Estimated lead time: 12 - 14
weeks for printed items from
approved art.



90%
Post Consumer
Waste

Paper Twist Handle Shopping Bags

- 100% recyclable
- Kraft: 90% post-consumer waste/ White: 100% virgin paper
- 110 gsm paper (80 gsm for kraft and black)
- Minimum order is 250/200 per colour per size

| CODE | TYPE | SIZE (inches) | CASE | 12 - Kraft PRICE/EACH | | 00 - White PRICE/EACH | | Tints PRICE/EACH | | Metallics PRICE/EACH | |
|--------------|--------------|-----------------------|------|--------------------------|--------|--------------------------|--------|---------------------|--------|-------------------------|--------|
| | | | | 250+ | 1000+ | 250+ | 1000+ | 250+ | 1000+ | 250+ | 1000+ |
| 230508 _ _ * | Prime | 5 x 3.5 x 8 x 3.5 | 250 | \$0.42 | \$0.36 | \$0.52 | \$0.41 | \$0.65 | \$0.55 | \$0.68 | \$0.58 |
| 230809 _ _ | Petite | 8 x 4.5 x 10.75 x 4.5 | 250 | \$0.47 | \$0.42 | \$0.52 | \$0.45 | \$0.68 | \$0.61 | \$0.72 | \$0.65 |
| 230914 _ _ | Vanity | 10 x 5 x 13 x 5 | 250 | \$0.52 | \$0.50 | \$0.57 | \$0.52 | — | — | — | — |
| 231315 _ _ | Celebrity | 13 x 6 x 15 x 6 | 250 | \$0.59 | \$0.55 | \$0.68 | \$0.63 | — | — | — | — |
| 231611 _ _ | Fashion | 16 x 6 x 12 x 6 | 250 | \$0.58 | \$0.55 | \$0.63 | \$0.57 | \$0.83 | \$0.73 | \$1.14 | \$1.04 |
| 231619 _ _ | Saville | 16 x 6 x 19 x 6 | ** | \$0.75 | \$0.64 | \$0.86 | \$0.75 | \$1.12 | \$1.03 | \$1.78 | \$1.65 |
| 231819 _ _ | Universal | 18 x 7 x 18.75 x 7 | 200 | \$0.77 | \$0.68 | \$0.83 | \$0.75 | — | — | — | — |
| 230513 _ _ | Wine Shopper | 5.25 x 3.5 x 13 | 250 | \$0.78 | \$0.73 | \$0.93 | \$0.87 | — | — | — | — |

Available Colours

| | 12 - Kraft | 00 - White | 35 - Black | 41 - Navy | 07 - Gold | 08 - Silver |
|-----------|------------|------------|------------|-----------|-----------|-------------|
| Prime | ✓ | ✓ | ✓ | ✓ | ✓ | ✓ |
| Petite | ✓ | ✓ | ✓ | ✓ | ✓ | ✓ |
| Vanity | ✓ | ✓ | — | — | — | — |
| Celebrity | ✓ | ✓ | — | — | — | — |
| Fashion | ✓ | ✓ | ✓ | ✓ | ✓ | ✓ |
| Saville | ✓ | ✓ | ✓ | ✓ | ✓ | ✓ |
| Universal | ✓ | ✓ | ✓ | ✓ | ✓ | ✓ |
| Wine | ✓ | ✓ | — | — | — | — |

* White and Kraft is 230508_ _P
* Black, Navy, Gold and Silver 230508_ _PR
** White and Kraft are sold in case packs of 200 and the Black, Navy, Gold
and Silver are sold in case packs of 250

Sturdy, durable.
Our best value bags.



DIGITAL PRINT
100+ \$2.45 each
1000+ \$2.25 each
300 bags minimum



FOIL PRINT
100+ 35¢ each
1000+ 32¢ each
2500+ 26¢ each



INK PRINT
100+ 34¢ each
1000+ 29¢ each
2500+ 24¢ each

Please allow 2 - 3 weeks
for printed items from
approved art.



Damask Paper Shoppers

- 110 gsm paper
- Minimum order is 100 per size

| CODE | TYPE | SIZE (inches) | CASE PACK | PRICE/EACH | |
|-----------|---------|-----------------|-----------|------------|--------|
| | | | | 100+ | 1000+ |
| 23080915D | Petite | 8 x 4 x 10 x 4 | 100 | \$0.67 | \$0.59 |
| 23101315D | Vanity | 10 x 5 x 13 x 5 | 100 | \$0.72 | \$0.62 |
| 23161215D | Fashion | 16 x 6 x 12 x 6 | 100 | \$0.84 | \$0.72 |



DIGITAL PRINT
100+ \$2.45 each
1000+ \$2.25 each
300 bags minimum



FOIL PRINT
100+ 35¢ each
1000+ 32¢ each
2500+ 26¢ each



INK PRINT
100+ 34¢ each
1000+ 29¢ each
2500+ 24¢ each

Please allow 2 - 3 weeks for printed
items from approved art.

All print orders subject to set-up charges. Applicable artwork, and plate charges may apply. See page 122.

IN STOCK

Paper Shoppers

The Mission Green Sustainable Solution for single-use plastic merchandise shoppers.

BAGS



70% Recycled Material



12KF - Kraft

00WF - White

Kraft Paper Bag with Die Cut Handles

- 70% post-consumer recycled material
- 90 gsm kraft paper
- 125 gsm kraft paper
- Durable reinforced handles
- Minimum order is 250 per colour per size

| CODE | SIZE (inches) | CASE PACK | PRICE/EACH | |
|------------|-----------------------|-----------|------------|--------|
| | | | 250+ | 1000+ |
| White: | | | | |
| 23101300WF | 10 x 3.14 x 13 x 3.14 | 250 | \$0.31 | \$0.28 |
| 23141800WF | 14 x 3.14 x 18 x 3.14 | 250 | \$0.41 | \$0.37 |
| Kraft: | | | | |
| 23141812KF | 14 x 3.14 x 18 x 3.14 | 250 | \$0.35 | \$0.31 |

Merchandise Die Cut Bags

- Reinforced fold-over handle plus side gusset
- 80 gsm paper

| CODE | SIZE (inches) | CASE PACK | PRICE/EACH |
|----------|---------------|-----------|------------|
| 23081275 | 8 x 2 x 12 | 500 | \$0.38 |
| 23101575 | 10 x 2 x 15 | 500 | \$0.42 |
| 23141875 | 14 x 4 x 18 | 250 | \$0.60 |



Merchandise Bags

- 110 gsm paper

| CODE | SIZE (in) | CASE | PRICE/EACH | |
|----------|-----------|------|------------|------------|
| | | | 75 - Kraft | 00 - White |
| 230609__ | 6 x 9 | 2000 | \$0.07 | \$0.09 |
| 230710__ | 7 x 10 | 500 | \$0.08 | \$0.08 |
| 230912__ | 9 x 12 | 500 | \$0.09 | \$0.13 |
| 231114__ | 11 x 14 | 500 | \$0.12 | \$0.18 |
| 231316__ | 13 x 16 | 500 | \$0.18 | \$0.23 |



75 - Kraft

00 - White



DIGITAL PRINT
100+ \$2.45 each
1000+ \$2.25 each
300 bags minimum



FOIL PRINT
100+ 35¢ each
1000+ 32¢ each
2500+ 26¢ each



INK PRINT
100+ 34¢ each
1000+ 29¢ each
2500+ 24¢ each

Please allow 2 - 3 weeks for printed items from approved art.

IN STOCK

Food Service Paper

BAGS



A

B



Tamper Proof Strips Across Both Sets of Handles



100% Recycled Material

Food Service Kraft Paper Shoppers

- Sturdy and durable
- 110 gsm
- Made from 100% recycled kraft paper

| CODE | DESCRIPTION | SIZE (inches) | CASE PACK | PRICE/EACH | |
|-------------|------------------------------|---------------------|-----------|------------|--------|
| | | | | 250+ | 1000+ |
| A 23121775F | SOS Shopper | 12 x 7 x 17 x 7 | 250 | \$0.26 | \$0.24 |
| B 23141512F | Paper Twist with Tamper Tape | 14 x 10 x 15.5 x 10 | 200 | \$0.82 | \$0.71 |



DIGITAL PRINT
100+ \$2.45 each
1000+ \$2.25 each
300 bags minimum



INK PRINT
100+ 34¢ each
1000+ 29¢ each
2500+ 24¢ each



FOIL PRINT
100+ 35¢ each
1000+ 32¢ each
2500+ 26¢ each

Please allow 2 - 3 weeks for printed items from approved art.

All print orders subject to set-up charges. Applicable artwork, and plate charges may apply. See page 122.

All print orders subject to set-up charges. Applicable artwork, and plate charges may apply. See page 122.

CREATE YOUR OWN LOOK

Full Colour Simply Poly Shopping Bags

Make a creative impression...
the combinations are endless!



Poly Shopping Bags

Customize simply and affordably.

| CODE | TYPE | STANDARD PRINT SIZE |
|--------|------------|---------------------|
| 550907 | Small Gift | 5" wide |
| 550414 | Wine | 2.5" wide |
| 550810 | Petite | 5" wide |
| 551612 | Fashion | 9" wide |
| 551816 | Majestic | 10" wide |

- Print two sides in 1 ink colour (maximum 25% ink coverage)
- Constructed of 3.0 mil high density poly
- Coordinating poly loop handles included in price
- Poly Shoppers minimum quantity 3,000 per size

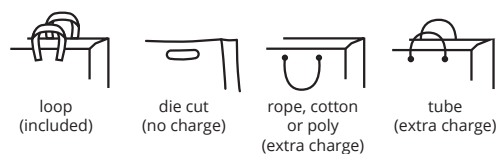

No Plate Charges*
*Does not include process plates.

Poly Merchandise Bags

| CODE | SIZE (in) | STANDARD PRINT SIZE |
|--------|-------------|---------------------|
| 550912 | 9 x 12 | 6" wide |
| 551114 | 11 x 14 | 7" wide |
| 551216 | 12 x 16 + 3 | 8" wide |
| 551416 | 14 x 16 + 3 | 10" wide |
| 551720 | 17 x 20 + 4 | 12" wide |
| 551816 | 18 x 16 + 4 | 13" wide |
| 552020 | 20 x 20 + 4 | 14" wide |
| 552024 | 20 x 24 + 4 | 14" wide |

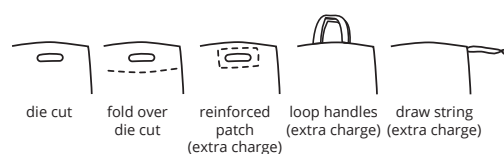

- Constructed of 1.5 mil gauge poly.
- Minimum quantity 5,000 (small sizes)/ 3,000 (large sizes).
- Print two sides in 1 ink colour (maximum 25% ink coverage).



Create Your Own Look:
Choose your bag style.
Send us your artwork.
For 100% full colour design, speak to your sales representative.

Estimated lead time: 14 - 16 weeks for printed items from approved art.

IN STOCK Poly Shoppers



Estimated lead time: 2 - 3 weeks for printed items from approved art.

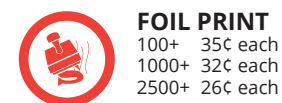

FOIL PRINT
100+ 35¢ each
1000+ 32¢ each
2500+ 26¢ each

Frosted Translucent Bags

- 2.0 mil clear HDPE merchandise, and 3.0 mil clear HDPE shoppers
- Minimum order one case pack
- Please allow 2 - 3 weeks for printed items from approved art

| CODE | TYPE | GAUGE | SIZE (in) | CASE PACK | PRICE/EACH |
|-------------|------------------|-------|-----------------|-----------|------------|
| A 55091200E | Merchandise | 2.0 | 9 x 12 | 1000 | \$0.10 |
| B 55141800E | Merchandise | 2.0 | 14 x 18 + 3 | 1000 | \$0.24 |
| C 55081000E | Petite Shopper | 3.0 | 8 x 4 x 10 x 4 | 250 | \$0.44 |
| D 55161200E | Fashion Shopper | 3.0 | 16 x 6 x 12 x 6 | 250 | \$0.63 |
| E 55181600E | Majestic Shopper | 3.0 | 18 x 6 x 16 x 6 | 250 | \$0.69 |



Foil Printed Merchandise Bags

- Constructed of 1.75 mil low density poly
- Foil Printing is available on one side only and is included in the price of the printed bags
- Minimum one case pack, printed and unprinted
- Die charge extra
- For no-print option please add N to code number

Estimated lead time: 2 - 3 weeks for printed items from approved art.

| CODE | HANDLE TYPE | SIZE (inches) | CASE PACK | PRICE/EACH | | |
|---------------|-------------|---------------|-----------|--------------------|--------------------|------------------|
| | | | | 1000 Foil Print | 3000 Foil Print | 1000 NO PRINT |
| A 220609 __ * | Notion | 6 x 9 | 1000 | \$0.24 | \$0.16 | \$0.11 |
| B 220811 __ * | Die Cut | 8.25 x 11 | 1000 | \$0.30 | \$0.23 | \$0.17 |
| C 221114 __ * | Die Cut | 11 x 14 | 1000 | \$0.32 | \$0.26 | \$0.18 |
| D 221418 __ | Die Cut | 14.5 x 18 | 1000 | \$0.40 | \$0.35 | \$0.21 |
| E 221721 __ | Patch | 16.5 x 20 + 4 | 500 | \$0.50 | \$0.43 | \$0.25 |

* Gold available in 3 sizes only

All print orders subject to set-up charges. Applicable artwork, and plate charges may apply. See page 122.

CREATE YOUR OWN LOOK

Reusable Fabric Style Shoppers

Make a creative impression...
the combinations are endless!



Full Colour Laminated Bags

- Plates extra per design/side.
Additions for extra charge
- Add matte lamination /bag
 - Add a carded bottom /bag
 - Zipper top /bag
 - Gusset print /bag

Shopping Bags (inches)

- 9 x 4 x 11 x 4
- 11 1/4 x 4 1/4 x 12 x 4 1/4
- 14 x 4 x 16 x 4
- 16 x 6 x 12 x 6
- 16 x 5 x 15 x 5

80 GSM NON-WOVEN
SILK SCREEN PRINT ONE COLOUR 2 SIDES
1"X24" HANDLES - "X" STITCH

100 GSM NON-WOVEN WITH LAMINATION
PRINT 4 COLOUR PROCESS
1"X24" PP WEBBING HANDLES - "X" STITCH

120 GSM PP WOVEN WITH LAMINATION
PRINT 4 COLOUR PROCESS
1"X24" PP WEBBING HANDLES - "X" STITCH



Non-woven Polypropylene

Soft, yet durable. Use this for light to medium weight loads.



Woven Polypropylene

Our strongest material. This rigid weave will handle heavy items.

Many more sizes available
- just ask!



Create Your Own Look:
Choose your bag style.
Send us your artwork.
For 100% full colour design, speak to your sales representative.

- Minimum quantity 2,000 per size
- Estimated lead time: 14 - 16 weeks for printed items from approved art.

IN STOCK

Reusable RPET Laminated Tote



Mission Green Sustainable solution made with 80% recycled RPET + Lamination

- 100 gsm with matte lamination
- Corner sewn style with RPET handle
- Small bag made with 7 recycled plastic bottles
- Large bag made with 11 recycled plastic bottles
- Eco-friendly, durable, recycled

RPET is known as Recycled Polyethylene Terephthalate. It's a strong, durable material constructed from 80% recycled plastic bottles.



| CODE | SIZE (inches) | CASE PACK | PRICE/EACH | |
|-----------|-----------------|-----------|------------|--------|
| | | | 100+ | 1000+ |
| 21081035R | 8 x 4 x 10 x 4 | 100 | \$1.68 | \$1.32 |
| 21141635R | 14 x 6 x 16 x 6 | 100 | \$2.43 | \$1.82 |

DIGITAL PRINT
100+ \$2.45 each
1000+ \$2.25 each
300 bags minimum

FOIL PRINT
100+ 35¢ each
1000+ 32¢ each
2500+ 26¢ each

Please allow 2 - 3 weeks for printed items from approved art.

All print orders subject to set-up charges. Applicable artwork, and plate charges may apply. See page 122.

SPECIAL ORDER

Reusable Fabric Shoppers

BAGS



New

Upcycle Laminated Totes

- RPET plus matte lamination
- W-fold bottom
- Eco-friendly, durable, recycled
- Small bag made of 2 water bottles - 140 gsm
- Medium bag made of 5 water bottles - 155 gsm
- Large bag made of 7 water bottles - 155 gsm

| CODE | DESCRIPTION | SIZE (inches) | CASE PACK | PRICE/EACH | |
|-----------|-------------|---------------|-----------|------------|--------|
| | | | | 150+ | 1000+ |
| 245905 __ | Small* | 8 x 10 x 5.25 | 225 | \$1.31 | \$1.24 |
| 245906 __ | Medium** | 12 x 14 x 7 | 150 | \$1.97 | \$1.87 |
| 245907 __ | Large** | 18 x 14 x 7.5 | 75 | \$2.48 | \$2.35 |

* 08 - Grey (available while quantities last)
** 08 - Grey (out of stock)

Toronto Totes

| CODE | DESCRIPTION | SIZE (inches) | CASE PACK | PRICE/EACH | |
|-----------|-------------|-----------------|-----------|------------|--------|
| | | | | 100+ | 1000+ |
| 215909 __ | Small Tote | 9 x 5 x 12 x 5 | 100 | \$1.81 | \$1.67 |
| 215916 __ | Large Tote | 16 x 6 x 14 x 6 | 100 | \$2.66 | \$2.09 |



FOIL PRINT*
100+ 35¢ each
1000+ 32¢ each
2500+ 26¢ each



DIGITAL PRINT
100+ \$2.45 each
1000+ \$2.25 each
300 bags minimum



15 - Black with White
00 - White with Black

* Only Gold, Silver, White and Black foil is available for printing..

Please allow 3 - 5 weeks for printed items from approved art.



Top Turn Graphics Illustrate Recycled Bottle Content

Available Colours



15 - Black 08 - Grey 00 - White

Please allow 3 - 5 weeks for printed items from approved art.



FOIL PRINT
75+ 35¢ each
1000+ 32¢ each
2500+ 26¢ each

Metallic Foil, Gloss Clear, Gloss Black and Satine Foil only.



IN STOCK

Reusable Shoppers

BAGS



A B



C D E F

| CODE | DESCRIPTION | SIZE (inches) | CASE PACK | PRICE/EACH | |
|--------------|----------------------------|-------------------------|-----------|------------|--------|
| | | | | 100+ | 1000+ |
| A 21141615B | Black Tote with 4" gusset | 14 x 4 x 16 x 4 | 100 | \$2.14 | \$1.52 |
| B 21111315BW | Six Bottle Wine Tote | 11.5 x 7.25 x 13 x 7.25 | 100 | \$3.01 | \$2.91 |
| C 21141655B | Black Tote with 8" gusset | 14 x 8 x 16 x 8 | 100 | \$2.32 | \$1.68 |
| D 21141609R | Red Tote with 8" gusset | 14 x 8 x 16 x 8 | 100 | \$2.34 | \$1.72 |
| E 21141675C | Large Kraft Composite Tote | 14 x 6 x 16 x 6 | 100 | \$2.58 | - |
| F 21081075C | Small Kraft Composite Tote | 8 x 4 x 10 x 4 | 100 | \$1.72 | - |



DIGITAL PRINT
100+ \$2.45 each
1000+ \$2.25 each
300 bags minimum



FOIL PRINT
100+ 35¢ each
1000+ 32¢ each
2500+ 26¢ each



SCREEN PRINT
100+ \$1.25 each
500+ \$1.08 each
1000+ 90¢ each

Estimated lead time:
2 - 3 weeks for printed items from approved art.

All print orders subject to set-up charges. Applicable artwork, and plate charges may apply. See page 122.

All print orders subject to set-up charges. Applicable artwork, and plate charges may apply. See page 122.

IN STOCK

Non-Woven Garment Covers

Great for resale or promotions!

| CODE | SIZE (inches) | CASE PACK | PRICE/EACH UNPRINTED |
|------------|---------------|-----------|----------------------|
| A 21244015 | 24 x 42 | 100 | \$3.62 |
| B 21245415 | 24 x 54 | 100 | \$5.18 |
| C 21247215 | 24 x 72 + 4 | 100 | \$8.53 |

Silk screen set-up charge: \$75.00

Please allow 2-3 weeks for printed items from approved art.

SCREEN PRINT
 100+ \$1.25 each
 500+ \$1.08 each
 1000+ 90¢ each



In Stock
 One roll, white with no print
\$373.75 any size
 21214000S, 21215400S, 21217300S

CREATE YOUR OWN LOOK

Non-Woven Garment Covers

Custom Colours Available

| SIZE | DESCRIPTION |
|-------------|--------------|
| 24 x 42 | Suit Bag |
| 24 x 54 | Coat Bag |
| 24 x 72 + 4 | Gown - Black |

Please allow 14 - 16 weeks from approved art for delivery.
 Minimum 1000 per size.

Pricing includes printing on one side with one colour.



BOXES

GIFT AND APPAREL



All print orders subject to set-up charges. Applicable artwork, and plate charges may apply. See page 122.

SPECIAL ORDER

IN STOCK

Malibu Magnetic Closure Gift Box

Dual purpose - great for gifting and use after. Perfect for e-commerce business subscriptions.

- Smooth paper covering
- Magnetic closures
- Three colours and three sizes
- Inserts available via special order. Ask your representative



00 - White

11 - Pewter

15 - Black

Please allow 3-5 weeks for printed items from approved art.

| CODE | DESCRIPTION | SIZE (in) | CASE PACK | PRICE/EACH |
|-----------|-------------|-----------------------|-----------|------------|
| 454103 __ | Small | 8.5 x 2.75 x 1.625 | 100 | \$3.67 |
| 454104 __ | Medium | 7.25 x 5.5 x 1.375 | 60 | \$5.03 |
| 454116 __ | Large | 10.75 x 7.125 x 1.625 | 40 | \$5.97 |



FOIL PRINT
Exterior and interior lid
40/60/100+ 35¢ each
1000+ 32¢ each
2500+ 26¢ each



Tuckit® Folding Gift Boxes

- One piece boxes fold and tuck together for a solid bottom
- 18 sizes available • 100% recycled content (min. 35% post consumer) - kraft excluded

Bottom tucks into place for a secure fit.



12P - Kraft PinStripe

00 - Gloss White

29 - Gloss Red

55 - Gloss Black

| CODE | SIZE (inches) | CASE PACK | ECONO WHITE PRICE/EACH | | KRAFT PRICE/EACH | | GLOSS COLOURS PRICE/EACH | |
|-------------|---------------|-----------|------------------------|--------|------------------|--------|--------------------------|--------|
| | | | 100+ | 1000+ | 100+ | 1000+ | 100+ | 1000+ |
| 334103 __ | 3 x 3 x 2 | 100 | \$0.54 | \$0.49 | \$0.47 | \$0.43 | N/A | N/A |
| 334180 __ | 3 x 3 x 3 | 100 | \$0.47 | \$0.42 | \$0.50 | \$0.45 | N/A | N/A |
| 334111 __ | 4 x 4 x 4 | 100 | \$0.62 | \$0.56 | \$0.61 | \$0.55 | \$1.10 | \$1.00 |
| 334115 __ | 6 x 4.5 x 4.5 | 100 | \$0.90 | \$0.82 | \$0.94 | \$0.86 | \$1.40 | \$1.27 |
| 334113 __ | 6 x 6 x 4 | 100 | \$1.19 | \$1.08 | \$1.19 | \$1.08 | \$1.92 | \$1.74 |
| 334114 __ | 6 x 6 x 6 | 100 | \$1.29 | \$1.17 | \$1.52 | \$1.38 | \$1.84 | \$1.67 |
| 334120 __ | 8 x 8 x 3.5 | 100 | \$2.03 | \$1.84 | \$2.07 | \$1.88 | \$2.92 | \$2.65 |
| 33412100 | 8 x 8 x 6 | 50 | \$3.02 | \$2.51 | N/A | N/A | N/A | N/A |
| 33412200 | 8 x 8 x 8.5 | 100 | \$3.48 | \$2.90 | N/A | N/A | N/A | N/A |
| 334119 __ | 9 x 4.5 x 4.5 | 100 | \$1.24 | \$1.13 | \$1.38 | \$1.26 | \$1.92 | \$1.74 |
| 334183 __ | 10 x 5 x 4 | 100 | \$1.36 | \$1.24 | \$1.17 | \$1.06 | N/A | N/A |
| * 334124 __ | 10 x 10 x 6 | 50 | \$3.59 | \$3.27 | \$3.88 | \$3.53 | \$4.81 | \$4.81 |
| * 334131 __ | 12 x 6 x 6 | 50 | \$2.19 | \$1.99 | \$1.97 | \$1.79 | \$2.51 | \$2.29 |
| * 334125 __ | 12 x 12 x 2.5 | 50 | \$2.52 | \$2.29 | \$3.55 | \$3.22 | \$2.16 | \$1.97 |
| * 334136 __ | 12 x 12 x 5.5 | 50 | \$4.33 | \$3.94 | \$4.83 | \$4.39 | \$3.38 | \$3.08 |
| 334186 __ | 14 x 6 x 6 | 50 | \$3.18 | \$2.90 | \$3.70 | \$3.37 | N/A | N/A |
| 33414500 | 14 x 14 x 5 | 25 | \$5.49 | \$4.99 | N/A | N/A | N/A | N/A |
| 33416700 | 16 x 16 x 7 | 25 | \$7.51 | \$6.83 | N/A | N/A | N/A | N/A |

* not available in Gloss Black

100% recycled content (min. 35% post consumer) - kraft excluded



FOIL PRINT
50/100+ 35¢ each
1000+ 32¢ each
2500+ 26¢ each

Please allow 3 - 5 weeks for printed items from approved art.



White Foldings

- Our most economical option ships flat and stores flat
- Please allow 2 - 3 weeks for printed items from approved art

Please allow 2 - 3 weeks for printed items from approved art.



FOIL PRINT
50/100+ 35¢ each
1000+ 32¢ each
2500+ 26¢ each



INK PRINT
50/100+ 34¢ each
1000+ 29¢ each
2500+ 24¢ each

| CODE | DESCRIPTION | SIZE (inches) | CASE | PRICE/EACH | |
|----------|---------------------------|-----------------|------|------------|--------|
| | | | | 100+ | 1000+ |
| 32058003 | G58 Baby Mugs | 3.5 x 3.5 x 2 | 100 | \$0.27 | \$0.23 |
| 32001003 | G1 Mugs | 4 x 4 x 4 | 100 | \$0.28 | \$0.24 |
| 32002003 | G2 Cups and Saucers | 6 x 6 x 4 | 100 | \$0.39 | \$0.35 |
| 32043003 | G43 Bowls, etc. | 10 x 8 x 4 | 100 | \$0.53 | \$0.50 |
| 32033003 | G33 Bowls, etc. | 10 x 10 x 6 | 100 | \$1.31 | \$1.15 |
| 32005003 | G5 Teapots, etc. | 8 x 8 x 5 | 100 | \$0.80 | \$0.72 |
| 32006003 | G6 Teapots, etc. | 8 x 8 x 8 | 100 | \$1.17 | \$1.06 |
| 32048003 | G48 Fork, Knife, Spoon | 13 x 4 x 2 | 100 | \$1.45 | \$1.31 |
| 32036003 | G36 Casseroles | 11 x 11 x 4.5 | 50 | \$1.31 | \$1.15 |
| 32013003 | G13 Plates | 5 x 5 x 2 | 100 | \$0.38 | \$0.32 |
| 32004003 | G4 Plates | 8 x 8 x 2 | 100 | \$0.68 | \$0.58 |
| 32008003 | G8 Plates | 11 x 11 x 2 | 100 | \$0.81 | \$0.72 |
| 32009003 | G9 Plates | 13.5 x 13.5 x 2 | 100 | \$1.10 | \$1.02 |
| 32040003 | G40 Plates | 15 x 15 x 2 | 50 | \$1.44 | \$1.30 |
| 32003003 | G3 All purpose | 7 x 4 x 3 | 100 | \$0.48 | \$0.43 |
| 32010003 | G10 All purpose | 9 x 4.5 x 4.5 | 100 | \$0.52 | \$0.46 |
| 32038003 | G38 All purpose | 12 x 4 x 4 | 100 | \$0.66 | \$0.60 |
| 32041003 | G41 All purpose | 10 x 7 x 7 | 100 | \$1.02 | \$0.96 |
| 32224003 | G24* 2-Piece Boxes - Base | 6 x 6 x 10 | 100 | \$0.73 | \$0.66 |
| 32124003 | G24* 2-Piece Boxes - Lid | | 100 | \$0.73 | \$0.66 |

* Must be ordered together. Pricing shown is for base and lid combined.



Apparel Boxes

Seven sizes* and four colours to choose from!

- Minimum order quantity is one case pack
- Please allow 2 - 3 weeks for printed in stock boxes from approved art

IN STOCK COLOURS



SPECIAL ORDER COLOUR

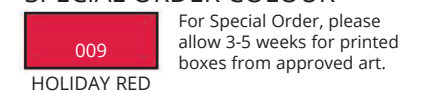

For Special Order, please allow 3-5 weeks for printed boxes from approved art.

| CODE | DESCRIPTION | CASE SIZE (inches) | PACK | WHITE PRICE /EACH | | KRAFT PINSTRIPE PRICE/EACH | | COLOURS PRICE/EACH | |
|-------------|----------------------------------|--------------------|------|-------------------|--------|----------------------------|--------|--------------------|--------|
| | | | | 100+ | 1000+ | 100+ | 1000+ | 100+ | 1000+ |
| A 32072 ___ | Glove/Sock* | 11.5 x 5.5 x 1.5 | 100 | \$1.47 | \$1.22 | \$1.63 | \$1.36 | — | — |
| B 32073 ___ | Lingerie/T-Shirt | 11.5 x 8.5 x 1.625 | 100 | \$1.65 | \$1.37 | \$1.70 | \$1.42 | \$2.98 | \$2.48 |
| C 32075 ___ | Shirt | 15 x 9.5 x 2 | 100 | \$1.81 | \$1.51 | \$1.92 | \$1.60 | \$4.15 | \$3.45 |
| D 32076 ___ | Sweater/Dress | 17 x 11 x 2.5 | 50 | \$3.05 | \$2.55 | \$3.22 | \$2.68 | \$5.77 | \$4.81 |
| E 32077 ___ | Jacket/Robe | 19 x 12 x 3 | 50 | \$4.07 | \$3.39 | \$3.78 | \$3.27 | \$6.65 | \$5.76 |
| F 32078 ___ | Coat/Gown | 24 x 14 x 4 | 25 | \$6.48 | \$5.61 | \$6.80 | \$5.89 | \$10.01 | \$8.67 |
| G 32071 ___ | Sweater (white only) (not shown) | 15 x 11 x 4.5 | 50 | \$4.91 | \$4.24 | — | — | — | — |



FOIL PRINT
25/50/100+ 35¢ each
1000+ 32¢ each
2500+ 26¢ each



INK PRINT
25/50/100+ 34¢ each
1000+ 29¢ each
2500+ 24¢ each

* Kraft pinstripe/White only

All print orders subject to set-up charges. Applicable artwork, and plate charges may apply. See page 122.

All print orders subject to set-up charges. Applicable artwork, and plate charges may apply. See page 122.

CREATE YOUR OWN LOOK



E-Commerce



CREATE YOUR OWN LOOK

Eco-Friendly, Recyclable
E-Commerce Packaging



Custom E-Commerce Gift Boxes

Go above and beyond to impress customers and exceed their expectations by delivering more than just a product, but also an experience.

- Please allow 12 - 14 weeks for printed items from approved art

SIZE (inches)

| |
|---------------------|
| 10 x 6 x 4 |
| 11.125 x 8.75 x 4 |
| 14.5 x 7.25 x 5 |
| 17 x 12 x 4.25 |
| 17.125 x 11.125 x 2 |

NO PLATE CHARGES!

Custom Poly Mailers

- 2.0 mil co-extruded LDPE film
- White exterior with black interior
- 2" adhesive lip
- Plate charges apply
- Please allow 12 - 14 weeks for printed items from approved art

SIZE (inches)

| |
|-----------------|
| 9 x 12 + 2 |
| 12 x 15 1/2 + 2 |
| 14 1/2 x 19 + 2 |
| 19 x 24 + 2 |

OTHER TYPES OF MAILERS AVAILABLE:

| Product Description | Minimum Qty |
|-----------------------|-------------|
| Recycled Poly Mailers | 25,000+ |
| Padded Paper Mailers | 40,000+ |
| Paper Apparel Mailers | 10,000+ |
| Rigid Paper Mailers | 10,000+ |
| Bubble Poly Mailers | 25,000+ |



50% Recycled Shell

Made in the US

Ask Your Representative For Details On Personalizing Your E-Commerce Mailers

10,000 minimum
1, 2 or 4 colour process. One or both sides



Create Your Own Look:

Choose your box style.
Send us your artwork.
For 100% full colour design, speak to your sales representative.

IN STOCK

Available for immediate shipment.

Deliver the 'in-store' experience to your customer's door.



Gift and Apparel Ecommerce

- Reversible kraft with oyster or black interior
- Study E Flute for safe delivery in 3 sizes
- Pack flat with 50 pieces/carton

| CODE | SIZE (inches) | CASE | OYSTER/KRAFT PRICE/EACH | | | BLACK/KRAFT PRICE/EACH | | |
|------------|-------------------------|------|-------------------------|--------|--------|------------------------|--------|--------|
| | | | 50+ | 500+ | 1000+ | 50+ | 500+ | 1000+ |
| 451009 ___ | 10.25 x 9.062 x 4.375 | 50 | \$2.34 | \$2.08 | \$1.87 | \$2.69 | \$2.39 | \$2.16 |
| 451511 ___ | 15.562 x 11.062 x 4.562 | 50 | \$3.33 | \$2.81 | \$2.55 | \$3.88 | \$3.28 | \$2.93 |
| 451612 ___ | 16.937 x 12.625 x 6.5 | 50 | \$4.31 | \$3.89 | \$3.45 | \$4.96 | \$4.47 | \$3.96 |

Add a Special Order Full Colour Seal. See page 120.

Add a customized In Stock Seal. See page 118.

Enquire about our Digital Print option!

Jewellery Boxes

For Geo, Velocity and Horizon packaging.

- Reversible kraft boxes with black or metallic bronze interior
- Black flock inserts available to fit Gold Galleria, Horizon, Geo or Velocity jewellery packaging*
- Minimum case pack 25



| CODE | DESCRIPTION | SIZE (inches) | PRICE/EACH | | |
|--------------------------------------|------------------------------|---------------------|------------|--------|--------|
| | | | 25+ | 250+ | 1000+ |
| 450505 ___ | Small Ecom Box | 5.75 x 5.75 x 2.5 | \$1.54 | \$1.46 | \$1.22 |
| 451010 ___ | Large Ecom Box | 10.25 x 10.25 x 2.5 | \$3.08 | \$2.83 | \$2.56 |
| Gold Galleria/Horizon Inserts | | | | | |
| 69221003H | Ring to fit small box | | \$0.57 | \$0.52 | \$0.38 |
| 69632003H | T-pad to fit small box | | \$0.57 | \$0.52 | \$0.38 |
| 69684003H | Utility to fit small box | | \$0.57 | \$0.52 | \$0.38 |
| 69693003H | Bracelet to fit large box | | \$0.93 | \$0.74 | \$0.66 |
| Geo Inserts | | | | | |
| 69221153G | Ring to fit small box | | \$0.57 | \$0.52 | \$0.38 |
| 69283153G | T-pad to fit small box | | \$0.57 | \$0.52 | \$0.38 |
| 69293153G | Bracelet to fit large box | | \$0.93 | \$0.74 | \$0.66 |
| 69273153G | Necklace to fit large box | | \$0.93 | \$0.74 | \$0.66 |
| Velocity Inserts | | | | | |
| 69321153V | Ring to fit small box | | \$0.57 | \$0.52 | \$0.38 |
| 69383153V | Utility pad to fit small box | | \$0.57 | \$0.52 | \$0.38 |
| 69393153V | Bracelet to fit large box | | \$0.93 | \$0.74 | \$0.66 |
| 69373153V | Necklace to fit large box | | \$0.93 | \$0.74 | \$0.66 |

* Inserts can be special ordered to fit any of our other jewellery packaging collections. Contact your sales representative for a quote.
Minimum order: 100 per size



FOIL PRINT
25+ 35c each
1000+ 32c each
2500+ 26c each

Please allow 2 - 3 weeks for printed items from approved art.

All print orders subject to set-up charges. Applicable artwork, and plate charges may apply. See page 122.

IN STOCK

Recyclable Ecommerce Mailer

- Natural brown kraft paper
- 150 gsm recycled paper - 40% PCW
- Strong and flexible with 3" gussets
- 1 sku - customizable to sizes



| CODE | SIZE (inches) | CASE PACK | PRICE/EACH | |
|----------|------------------|-----------|------------|--------|
| | | | 200+ | 1000+ |
| 52524512 | 20.5 x 3 x 17.75 | 200 | \$1.03 | \$0.91 |

| FOIL PRINT | | |
|------------|----------|--|
| 200+ | 35c each | |
| 1000+ | 32c each | |
| 2500+ | 26c each | |

ECO-FRIENDLY – “BE PROUD OF THE WAY YOU SHIP”



A Recycled Poly Mailers

| - IN STOCK - | | | | |
|--------------|-----------|------|------------|--------|
| CODE | SIZE (in) | CASE | PRICE/EACH | |
| | | | 1+ | 4+ |
| 52091286 | 9 x 12 | 1000 | \$0.57 | \$0.54 |
| 52101386 | 10 x 13 | 1000 | \$0.60 | \$0.57 |
| 52121586 | 12 x 15.5 | 500 | \$0.79 | \$0.75 |

| - SPECIAL ORDER - | | | | |
|-------------------|------------|------|------------|--------|
| CODE | SIZE (in) | CASE | PRICE/EACH | |
| | | | 1+ | 4+ |
| 52060986 | 6 x 9 | 1000 | \$0.41 | \$0.39 |
| 52071086 | 7.5 x 10.5 | 1000 | \$0.48 | \$0.45 |
| 52141986 | 14.5 x 19 | 250 | \$1.33 | \$1.26 |
| 52192486 | 19 x 24 | 125 | \$2.16 | \$2.04 |
| 52242486 | 24 x 24 | 125 | \$2.92 | \$2.77 |

B Padded Paper Mailers

| - IN STOCK - | | | | |
|--------------|-----------|------|------------|--------|
| CODE | SIZE (in) | CASE | PRICE/EACH | |
| | | | 1+ | 4+ |
| 52060976 | 6 x 9 | 250 | \$0.87 | \$0.83 |
| 52081176 | 8.5 x 11 | 100 | \$1.38 | \$1.31 |

| - SPECIAL ORDER - | | | | |
|-------------------|-----------|-------|------------|--------|
| CODE | SIZE (in) | CASE | PRICE/EACH | |
| | | | 1+ | 4+ |
| 52101576 | 10.5 x 15 | 2 100 | \$2.04 | \$1.93 |

C Paper Apparel Mailers

| - IN STOCK - | | | | |
|--------------|---------------|------|------------|--------|
| CODE | SIZE (in) | CASE | PRICE/EACH | |
| | | | 1+ | 4+ |
| 52101375 | 10 x 13 | 250 | \$1.46 | \$1.39 |
| 52121575 | 12 x 15.5 | 150 | \$1.96 | \$1.85 |
| 52101975 | 10.5 x 4 x 19 | 100 | \$2.32 | \$2.20 |

| - SPECIAL ORDER - | | | | |
|-------------------|-----------|------|------------|--------|
| CODE | SIZE (in) | CASE | PRICE/EACH | |
| | | | 1+ | 4+ |
| 52070975 | 7 x 9 | 250 | \$0.95 | \$0.90 |

D Rigid Paper Mailers

| - IN STOCK - | | | | |
|--------------|--------------|------|------------|--------|
| CODE | SIZE (in) | CASE | PRICE/EACH | |
| | | | 1+ | 4+ |
| 52061012 | 6 x 10 | 500 | \$0.68 | \$0.65 |
| 52061212 | 6 x 2.5 x 12 | 500 | \$0.98 | \$0.93 |
| 52091412 | 9.5 x 14.5 | 250 | \$1.19 | \$1.12 |

| - SPECIAL ORDER - | | | | |
|-------------------|-----------|------|------------|--------|
| CODE | SIZE (in) | CASE | PRICE/EACH | |
| | | | 1+ | 4+ |
| 52081212 | 8.5 x 12 | 250 | \$0.90 | \$0.85 |
| 52101612 | 10.5 x 16 | 250 | \$1.43 | \$1.35 |
| 52121912 | 12.5 x 19 | 250 | \$1.62 | \$1.53 |

For more product information on recyclability and material content, visit gunthermele.com



100% Recycled Shell
Made in the US



FOIL PRINT
100+ 35c each
1000+ 32c each
2500+ 26c each



PAD PRINT
100+ 35c each
1000+ 32c each
2500+ 26c each



INK PRINT
100+ 34c each
1000+ 29c each
2500+ 24c each



All print orders subject to set-up charges. Applicable artwork, and plate charges may apply. See page 122.

FINISHING TOUCHES

RIBBON, TISSUE, WRAP AND SEALS



All print orders subject to set-up charges. Applicable artwork, and plate charges may apply. See page 122.

IN STOCK

Inspirations Gift Wrap

Inspirations
Giftwrap

By Gunther Mele
Available for immediate shipment.



Inspirations
Giftwrap

By Gunther Mele
Available for immediate shipment.

IN STOCK

Inspirations Gift Wrap

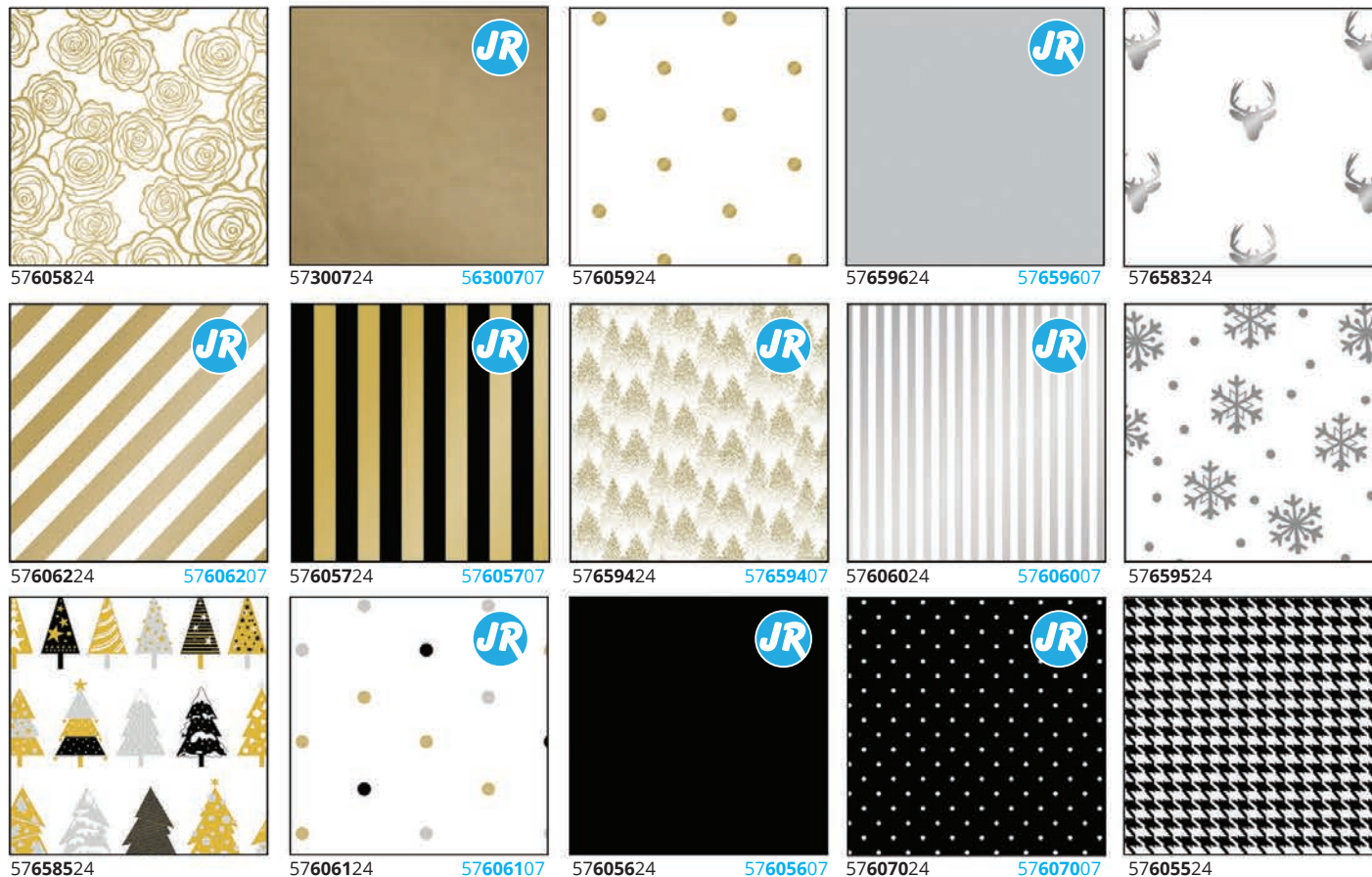

24" x 417' - 1/2 Ream Roll
\$103.88 each
Code # 57 ____ 24

8" x 150' - Jewellers Rolls **\$42.40** each
Code # 57 ____ 07

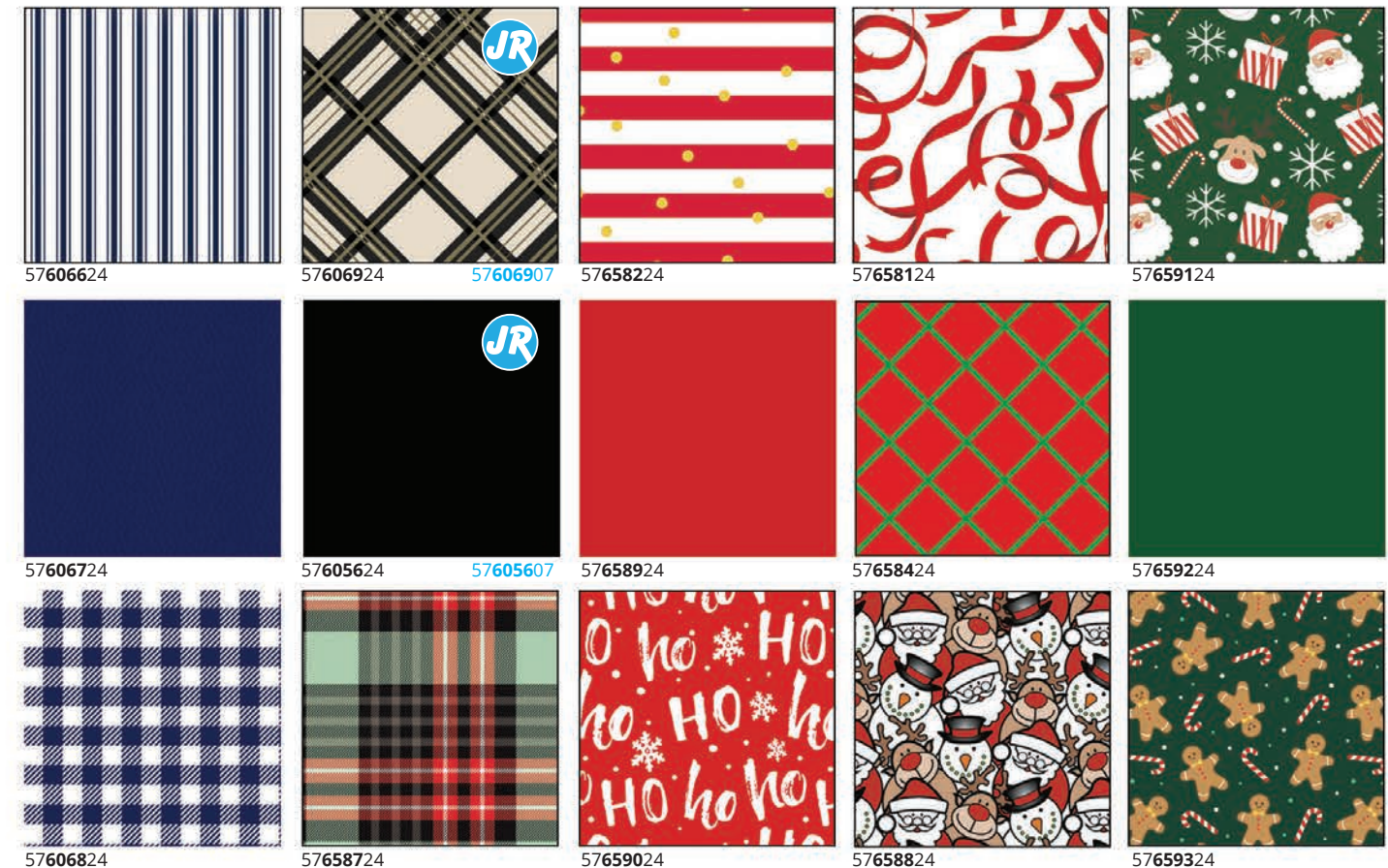

24" x 417' - 1/2 Ream Roll
\$103.88 each
Code # 57 ____ 24

8" x 150' - Jewellers Rolls **\$42.40** each
Code # 57 ____ 07

GIFT WRAP

GIFT WRAP

SPECIAL ORDER

Sullivan Designs Seasonal

Please allow 4 - 6 weeks for shipment.

GIFT WRAP



SPECIAL ORDER

Sullivan Designs Every Day

Please allow 4 - 6 weeks for shipment.

GIFT WRAP

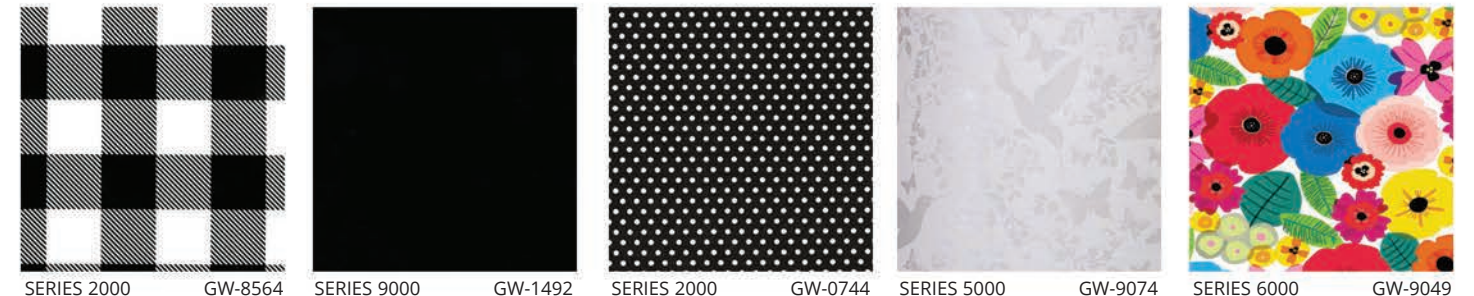

Additional custom order designs available to choose from. Contact your area sales representative for more info.

SULLIVAN designs available in 1/2 Ream Rolls and Full Ream Rolls

NOTE: All Sullivan gift wrap orders must include GW design code.

MINIMUM ORDER: 1 Roll per design (15" rolls must be ordered in multiples of 2 rolls per design)

SLITTING CHARGE: A slitting charge of \$25.00 applies to each individual roll. No more than two slits per roll; (2 slits = \$25.00)

| Pricing Level | 15H | 24H | 30H | 15F | 24F | 30F |
|---------------|-------------------------|-------------------------|-------------------------|-------------------------|-------------------------|-------------------------|
| | Half Ream 15" x 417' | Half Ream 24" x 417' | Half Ream 30" x 417' | Full Ream 15" x 833' | Full Ream 24" x 833' | Full Ream 30" x 833' |
| 2000 Series | \$170.89 | \$273.18 | \$314.72 | \$297.61 | \$484.80 | \$568.15 |
| 5000 Series | \$199.19 | \$321.88 | \$370.56 | \$352.83 | \$580.60 | \$677.83 |
| 6000 Series | \$234.52 | \$383.50 | \$441.23 | \$425.56 | \$691.18 | \$819.30 |
| 9000 Series | \$274.24 | \$451.80 | \$520.65 | \$502.85 | \$840.44 | \$977.87 |
| 9500 Series | \$302.75 | \$501.32 | \$577.68 | \$560.02 | \$939.62 | \$1092.21 |

View our entire
Selection online at
GUNTHERMELE.COM

Jewellers Rolls

Size: 7.375" x 150"

\$80.45/roll

Minimum order 1 roll.
JRX150 - Jeweller Roll suffix code.

Counter Rolls

Size: 24" x 100"

\$110.44/roll

Minimum order 1 roll.
-24X100 - Counter Roll suffix code.
Note: Sullivan does not allow counter roll slitting.

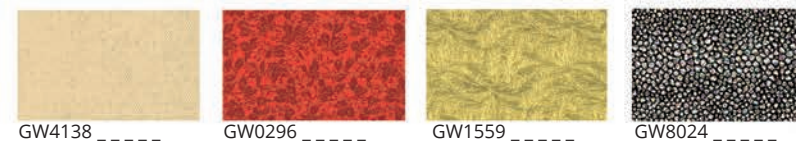

GW4138 _____ GW0296 _____ GW1559 _____ GW8024 _____



GW3009 _____ GW0396 _____ GW1912 _____ GW0738 _____



GW1933 _____



Gift wrap dispenser with serrated edge
can be added to your custom jewellers roll
order for \$7.42 each.
Code: 09715000

SPECIAL ORDER

Shamrock Designs Seasonal

Please allow 4 - 6 weeks for shipment.

GIFT WRAP



SPECIAL ORDER

Shamrock Designs Every Day

Please allow 4 - 6 weeks for shipment.

GIFT WRAP

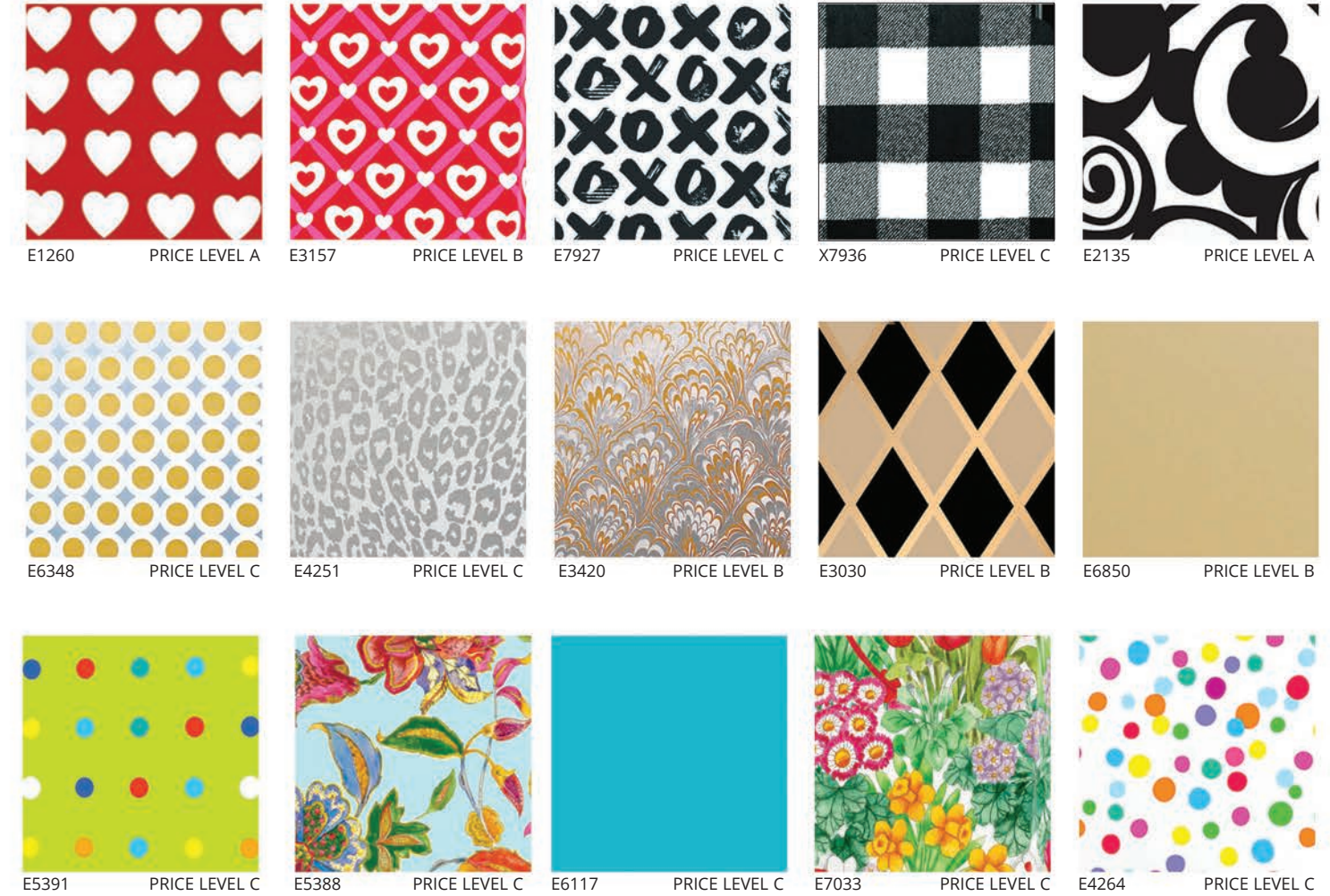

Additional custom order designs available to choose from. Contact your area sales representative for more info.

Shamrock designs available in Cutter Boxes, 1/2 Ream Rolls and Full Ream Rolls

View our entire Selection online at GUNTHERMELE.COM

NOTE: All Shamrock gift wrap orders must include design code.

MINIMUM ORDER: 1 Roll

Jewellers Rolls also available. Most are minimum 3 rolls per design.*

SLITTING CHARGE: A slitting charge of \$25.00 applies to each individual roll. (no more than two slits per roll - 2 slits = \$25.00)

Contact your sales representative for details.* Select designs available in 1 roll minimums.

| Pricing Level | 7J | 24C | 18H | 24H | 30H | 36H | 18F | 24F | 30F | 36F |
|---------------|----------------------------|-----------------------|----------------------|----------------------|----------------------|----------------------|----------------------|----------------------|----------------------|----------------------|
| | Jewellers Roll 7.375"x100' | Cutter Box 24" x 100' | Half Ream 18" x 417' | Half Ream 24" x 417' | Half Ream 30" x 417' | Half Ream 36" x 417' | Full Ream 18" x 833' | Full Ream 24" x 833' | Full Ream 30" x 833' | Full Ream 36" x 833' |
| A | \$31.75 | \$63.02 | \$199.11 | \$180.55 | \$287.57 | \$328.54 | \$324.10 | \$305.66 | \$458.55 | \$551.34 |
| B | \$38.98 | \$77.50 | \$246.96 | \$228.52 | \$341.73 | \$413.62 | \$423.66 | \$404.98 | \$607.47 | \$732.35 |
| C | \$46.33 | \$92.32 | \$283.95 | \$265.40 | \$398.10 | \$482.36 | \$493.56 | \$475.12 | \$712.74 | \$857.00 |
| D | \$49.95 | \$99.79 | \$283.95 | \$287.57 | — | — | \$541.41 | \$522.97 | — | — |

CREATE YOUR OWN LOOK

• Please allow 6 - 8 weeks for printed items from approved art.



Printed Tissue: Pick a PMS print colour and we will match it.

– See page 105 for Special Order Tissue Colours!

| CODE | DESCRIPTION | SIZE (in) | PACKAGED | PRICE/EACH | |
|------------|--------------|-----------|----------|------------|----------|
| | | | | 10 REAMS | 30 REAMS |
| 20869000G | White | 20 X 30 | 480 | \$119.46 | \$103.36 |
| 20869000M | Coloured | 20 x 30 | 480 | \$171.24 | \$148.17 |
| 20869000GK | Kraft | 20 x 30 | 480 | \$119.46 | \$103.36 |
| 20869001M | Metallic SS* | 20 x 30 | 200 | \$283.39 | \$268.74 |

* SS - single sided

Print included in price of tissue.

Minimum 10 reams. Note: Plates extra \$310.00 (per colour).
Ships in approximately 6 - 8 weeks.

For metallic ink print: add 10% to the price above.
For > 50% ink coverage, an additional \$10 per ream.
All custom orders subject to a +/-10% over/under run.

Custom Printed
White Tissue – 10 Reams
\$1194.60

IN STOCK

Available for immediate shipment.

Spotlight Tissue Colours

| CODE | DESCRIPTION | SIZE (in) | PKG | PRICE/EACH | | |
|-----------|-------------------------------|-------------|--------|---------------|----------|-----------|
| | | | | 1 - 4 REAMS | 5+ REAMS | 25+ REAMS |
| 20819290S | White Economy | 19 x 29 | 480 | \$20.78 | \$17.80 | \$14.84 |
| 208551__G | Spotlight on Value (colours) | 20 x 30 | 480 | \$39.74 | \$39.74 | \$39.74 |
| 208559__G | Spotlight on Value (metallic) | 20 x 30 | 200 | \$71.55 | \$70.22 | \$68.90 |
| 20850102 | #1 White Economy | 19 x 14.5 | 480 | \$10.00 | \$8.75 | \$7.19 |
| 20851800 | #1 White Bleached | 18 x 9 dia. | 1 roll | \$118.72/roll | | |
| 20852000 | #1 White Bleached | 20 x 9 dia. | 1 roll | \$146.92/roll | | |

12 in stock tissue colours to choose from.
Plus check out our assorted Pre-Pack!



Spring Assortment Pre-Pack
20855100G - 20 x 30" - \$21.25/Pack
Contains 100 of each:
Green, Lemon, Tangerine, Pink, Blue.

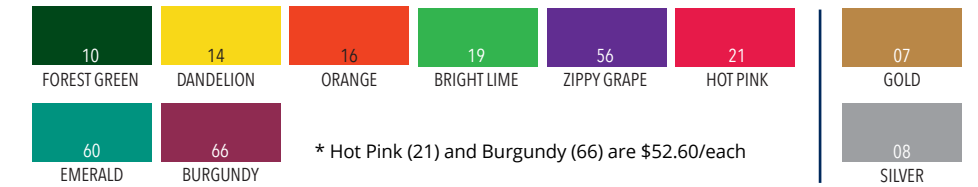

* Hot Pink (21) and Burgundy (66) are \$52.60/each

SPECIAL ORDER

Unprinted Tissue

Unprinted, minimum 1 ream (per colour).
Ships in approximately 4 - 6 weeks.

| CODE | DESCRIPTION | SIZE (in) | Packaged | PRICE/REAM | |
|---------|-----------------------|-----------|------------|------------|-----------|
| | | | | 1 REAM | 25+ REAMS |
| 20899__ | Special Order Colours | 20 x 30 | 480 sheets | \$51.16 | \$44.88 |

| | | | | | | | | | | |
|--------------------------|-------------------------|-------------------------|------------------------|-------------------------|--------------------------|-------------------------|------------------------|-------------------------|---------------------|-----------------------|
| NE-100 LIGHT PINK | NE-110 PINK | NE-120 CORAL ROSE | NE-124 AZALEA | NE-126 SCARLET | NE-130 RED | NE-131 DEEP SCARLET | NE-145 FUCHSIA | NE-148 HOT PINK | NE-150 CERISE | NE-155 ZIPPY GRAPE |
| NE-160 PURPLE | NE-164 SANDSTONE | NE-165 BURGUNDY | NE-170 DUBONNET | NE-190 PEACH | NE-195 TANGERINE | NE-200 ORANGE | NE-210 LIGHT YELLOW | NE-220 YELLOW | NE-222 DANDELION | NE-223 OATMEAL |
| NE-226 POPPY | NE-230 GOLDENROD | NE-235 PISTACHIO | NE-246 EMERALD | NE-247 JADE | NE-245 PALE MINT | NE-250 MID GREEN | NE-251 GROOVY GREEN | NE-255 BRIGHT LIME | NE-265 TEAL | NE-266 BALSAM |
| NE-269 OASIS GREEN | NE-270 DARK GREEN | NE-273 FESTIVE GREEN | NE-274 CEDAR GREEN | NE-275 FOREST GREEN | NE-277 TAPESTRY GREEN | NE-278 AZURE | NE-279 OXFORD BLUE | NE-281 BLUE BREEZE | NE-300 TURQUOISE | NE-305 CERULEAN |
| NE-306 BRILLIANT BLUE | NE-308 SAPPHIRE | NE-310 DARK BLUE | NE-325 LILAC | NE-330 LAVENDER | NE-335 PERIWINKLE | NE-338 LILAC PERFUME | NE-340 PLUM | NE-341 RASPBERRY FIZ | NE-345 CRANBERRY | NE-347 CRÈME |
| NE-350 FRENCH VANILLA | NE-354 SHADOW GREY | NE-356 GRANITE | NE-357 NOBLE GOLD | NE-359 ESPRESSO | NE-360 DESERT TAN | NE-361 BERMUDA SAND | NE-362 TERRA COTTA | NE-366 BURNT SIENNA | NE-370 CHOCOLATE | NE-371 RAW SIENNA |
| NE-375 ANTIQUÉ BLUE | NE-382 COLONIAL BLUE | NE-385 NAVY BLUE | NE-386 MORNING MIST | NE-389 MOUNTAIN MIST | NE-390 GRAY | NE-400 BLACK | NE-410 BIRCH | NE-415 DUNE BEIGE | NE-417 PARCHMENT | |

IN STOCK

Available for immediate shipment.

Curling Ribbon

See chart for available colours

| CODE | PRICE/ROLL |
|--|------------|
| COLOURS - 3/16" x 500 yards 148373 __ | \$4.53 |
| METALLIC - 3/16" x 250 yards 148378 __ | \$12.27 |



2.75" Star Bows

See chart for available colours

| CODE | CASE PACK | PRICE/EACH 200+ | 1000+ |
|---|-----------|-----------------|--------|
| COLOURS - 2.75" x 17 loop 142311 __ | 200 | \$0.19 | \$0.17 |
| METALLIC - 2.5" x 17 loop 14531107 Gold | 200 | \$0.19 | \$0.17 |
| 14531108 Silver | 200 | \$0.19 | \$0.17 |

Min: case pack



3.75" Star Bows

See chart for available colours

| CODE | CASE PACK | PRICE/EACH 100+ | 1000+ |
|--|-----------|-----------------|--------|
| COLOURS - 3.75" x 13 loop 143512 __ | 200 | \$0.20 | \$0.18 |
| METALLIC - 3.75" x 17 loop 14551207 Gold | 200 | \$0.29 | \$0.26 |
| 14551208 Silver | 200 | \$0.29 | \$0.26 |

Min: case pack

Splendor Ribbon

See chart for available colours

| CODE | PRICE/ROLL |
|---|------------|
| COLOURS - 3/4" x 250 yards 141050 __ | \$12.46 |
| METALLIC - 3/4" x 100 yards 14013007 Gold | \$16.60 |
| 14013008 Silver | \$15.60 |



99 - Everyday Assortment Star Bows
Available in 2.75" and 3.75"



98 - Christmas Assortment Star Bows
Available in 2.75" and 3.75"



Metallic Star Bows
Available in 2.75" and 3.75"

| Color # Name | Curling Ribbon | 2.75" Star Bows | 3.75" Star Bows | Splendor Ribbon |
|---------------------------|----------------|-----------------|-----------------|-----------------|
| 00 - White | | | | |
| 86 - Ivory | | | | |
| 29 - Vanilla | | | | |
| 61 - Pastel Yellow | | | | |
| 03 - Yellow | | | | |
| 13 - Daffodil | | | | |
| 14 - Sunshine Yellow | | | | |
| 07 - Gold | | | | |
| 08 - Silver | | | | |
| 27 - Holiday Gold | | | | |
| 22 - Melon | | | | |
| 73 - Coral | | | | |
| 16 - Tropical Orange | | | | |
| 17 - Orange | | | | |
| 12 - Chocolate | | | | |
| 75 - Baby Pink | | | | |
| 01 - Pink | | | | |
| 80 - Primrose | | | | |
| 57 - Azalea | | | | |
| 09 - Red | | | | |
| 58 - Lava Red | | | | |
| 66 - Burgundy | | | | |
| 41 - Beauty | | | | |
| 59 - Dubonnet Rose | | | | |
| 28 - Orchid | | | | |
| 05 - Lavender | | | | |
| 56 - Purple | | | | |
| 54 - Periwinkle | | | | |
| 50 - Plum | | | | |
| 11 - Royal | | | | |
| 81 - Navy | | | | |
| 77 - Baby Blue | | | | |
| 02 - Light Blue | | | | |
| 47 - Aqua | | | | |
| 32 - Caribbean Blue | | | | |
| 55 - Robin's Egg | | | | |
| 25 - Turquoise | | | | |
| 71 - Sea Green | | | | |
| 18 - Celery | | | | |
| 74 - Spruce | | | | |
| 60 - Hunter | | | | |
| 84 - Teal | | | | |
| 04 - Mint | | | | |
| 19 - Citrus | | | | |
| 96 - Leaf | | | | |
| 30 - Celadon | | | | |
| 10 - Emerald | | | | |
| 70 - Antique Silver | | | | |
| 15 - Black | | | | |
| 07 - Metallic Gold | | | | |
| 08 - Metallic Silver | | | | |
| 09 - Metallic Red | | | | |
| 10 - Metallic Green | | | | |
| 99 - Everyday Assortment | N/A | | | N/A |
| 98 - Christmas Assortment | N/A | | | N/A |

IN STOCK

Available for immediate shipment.

Perfect Bows™

Minimum: 50 per size, per colour.

| CODE | SIZE | PRICE/EACH | |
|-----------|------------------|------------|--------|
| | | 50+ | 1000+ |
| 140515 __ | 5.5" Perfect Bow | \$1.41 | \$1.27 |



Pull Bows

Minimum: 100 per size, per colour.

| CODE | SIZE | PRICE/EACH | | | |
|-----------|----------------|-----------------------|--------|-----------------------|--------|
| | | STANDARD COLOURS 100+ | 1000+ | METALLIC COLOURS 100+ | 1000+ |
| 132000 __ | Petite 2" Bows | \$0.25 | \$0.22 | \$0.40 | \$0.37 |
| 134000 __ | Std. 4" Bows | \$0.42 | \$0.38 | \$0.68 | \$0.63 |



Mini Metallic Star Bows

252 per tub

| CODE | DESCRIPTION | PRICE/TUB |
|----------|-------------|-----------|
| 14121099 | Assorted | \$39.60 |
| 14121017 | Gold | \$39.60 |
| 14121008 | Silver | \$39.60 |



Matte Wrapphia™

| CODE | SIZE | PRICE/ROLL |
|-----------|---------|------------|
| 148367 __ | 100 yds | \$10.22 |



Paper Roll/Ream Dispenser and Tape

| CODE | DESCRIPTION | PRICE |
|----------|---|--------------|
| 09850124 | Paper Roll/Ream Roll dispenser - 24" rack | \$80.04 each |

Ribbon Shredder

CODE: 09878600
PRICE: \$8.61 each



Curling Ribbon Roll Dispenser

CODE: 09850100
PRICE: \$136.35 each



Holds 12 Rolls

Cellophane (1.0mil)

| CODE | DESCRIPTION | SIZE | PRICE/ROLL |
|----------|------------------|------------|------------|
| 16400506 | Clear Cellophane | 40" x 100' | \$20.64 |
| 16300506 | Clear Cellophane | 40" x 300' | \$57.10 |

RIBBON

RIBBON

SPECIAL ORDER

RIBBON

Printed Satin Ribbon

See chart to the right for ribbon colours.

Single Face Satin

| WIDTH | CODE | PRICE/EA |
|---|----------|----------|
| 3/8" x 100 yd roll | 14150002 | \$47.56 |
| 5/8" x 100 yd roll | 14150003 | \$50.88 |
| 7/8" x 100 yd roll | 14150005 | \$59.21 |
| 1-1/2" x 100 yd roll (2 x 50 yd rolls) | 14150015 | \$95.11 |

500 yard minimum per width. Note: Plates extra \$77.00 (per colour).



Contact your sales representative.



5/8" Single Face Satin Ribbon with Foil Print

Please allow 3-4 weeks for printed items from approved art.

Foil Print Colours

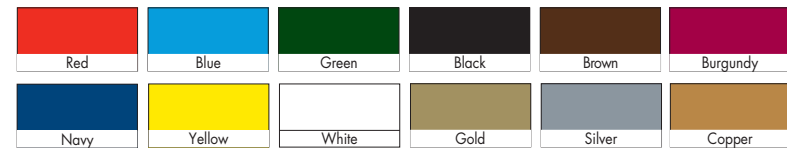

FOIL PRINT
Included in price of ribbon

Unprinted Satin and Grosgrain Ribbon

Lead time please allow 4-6 weeks for shipment. SPECIAL ORDER

See chart to the right for ribbon colours.

Single Face Satin

| WIDTH | CODE | PRICE/EA |
|---------------------|-----------|----------|
| 3/8" x 100 yd roll | 14031 ___ | \$22.38 |
| 5/8" x 100 yd roll | 14032 ___ | \$24.00 |
| 7/8" x 100 yd roll | 14033 ___ | \$39.66 |
| 1-1/2" x 50 yd roll | 14034 ___ | \$29.74 |

1 roll minimum.

Grosgrain

| WIDTH | CODE | PRICE/EA |
|---------------------|-----------|----------|
| 3/8" x 100 yd roll | 14160 ___ | \$22.56 |
| 5/8" x 100 yd roll | 14161 ___ | \$27.33 |
| 7/8" x 100 yd roll | 14162 ___ | \$40.36 |
| 1-1/2" x 50 yd roll | 14170 ___ | \$27.53 |

All print orders subject to set-up charges. Applicable artwork, and plate charges may apply. See page 122.

SPECIAL ORDER

While we strive for accuracy in our catalogue, actual product may be slightly different than pictured.

Please allow 3-4 weeks for printed items from approved art.

RIBBON

| 3/8" | | 5/8" | | 7/8" | | 1-1/2" | | COLOUR NUMBER AND NAME |
|-------------------|-----------|-------------------|-----------|-------------------|-----------|-------------------|-----------|------------------------|
| Single Face Satin | Grosgrain | Single Face Satin | Grosgrain | Single Face Satin | Grosgrain | Single Face Satin | Grosgrain | |
| | | | | | | | | 029 - White |
| | | | | | | | | 007 - Shell Grey |
| | | | | | | | | 012 - Silver |
| | | | | | | | | 015 - Grey |
| | | | | | | | | 022 - Pewter |
| | | | | | | | | 028 - Antique White |
| | | | | | | | | 813 - Oyster |
| | | | | | | | | 016 - Portobello |
| | | | | | | | | 030 - Black |
| | | | | | | | | 115 - Powder Pink |
| | | | | | | | | 117 - Light Pink |
| | | | | | | | | 150 - Pink |
| | | | | | | | | 156 - Hot Pink |
| | | | | | | | | 175 - Shocking Pink |
| | | | | | | | | 187 - Azalea |
| | | | | | | | | 241 - Living Coral |
| | | | | | | | | 250 - Red |
| | | | | | | | | 252 - Hot Red |
| | | | | | | | | 260 - Scarlet |
| | | | | | | | | 275 - Wine |
| | | | | | | | | 277 - Burgundy |
| | | | | | | | | 285 - Plum |
| | | | | | | | | 305 - Light Blue |
| | | | | | | | | 331 - Dusty Blue |
| | | | | | | | | 312 - Blue |
| | | | | | | | | 315 - Navajo Turquoise |
| | | | | | | | | 329 - Cobalt |
| | | | | | | | | 340 - Turquoise |
| | | | | | | | | 343 - Tornado Blue |
| | | | | | | | | 350 - Royal |
| | | | | | | | | 352 - Electric Blue |
| | | | | | | | | 353 - Century Blue |
| | | | | | | | | 365 - Light Navy |
| | | | | | | | | 370 - Navy |
| | | | | | | | | 412 - Purple Haze |
| | | | | | | | | 430 - Light Orchid |
| | | | | | | | | 450 - Orchid |
| | | | | | | | | 462 - Royal Orchid |
| | | | | | | | | 464 - Delphinium |
| | | | | | | | | 465 - Purple |
| | | | | | | | | 470 - Regal Purple |
| | | | | | | | | 473 - Amethyst |
| | | | | | | | | 528 - Lemon Grass |
| | | | | | | | | 530 - Mint |
| | | | | | | | | 533 - Jungle Green |
| | | | | | | | | 547 - New Chartreuse |
| | | | | | | | | 548 - Kiwi |
| | | | | | | | | 550 - Apple Green |
| | | | | | | | | 558 - Leaf |
| | | | | | | | | 567 - Spring Moss |
| | | | | | | | | 570 - Moss |
| | | | | | | | | 580 - Emerald |
| | | | | | | | | 586 - New Neon Green |
| | | | | | | | | 587 - Forest Green |
| | | | | | | | | 617 - Baby Maize |
| | | | | | | | | 640 - Lemon |
| | | | | | | | | 645 - Daffodil |
| | | | | | | | | 650 - Maize |
| | | | | | | | | 660 - Yellow Gold |
| | | | | | | | | 675 - Gold |
| | | | | | | | | 690 - Old Gold |
| | | | | | | | | 722 - Burnt Sienna |
| | | | | | | | | 743 - Ginger |
| | | | | | | | | 750 - Torrid Orange |
| | | | | | | | | 789 - Sherry |
| | | | | | | | | 790 - Currant |
| | | | | | | | | 810 - Ivory |
| | | | | | | | | 815 - Cream |
| | | | | | | | | 825 - Natural |
| | | | | | | | | 835 - Tan |
| | | | | | | | | 841 - Khaki |
| | | | | | | | | 850 - Brown |
| | | | | | | | | 866 - Coffee |

IN STOCK

In stock and ready to ship.

Simply Sheer Asiana Ribbon



Monofilament-Edge

| CODE | SIZE | PRICE/ROLL |
|-----------|--------------------|------------|
| 149435 __ | 7/8" x 100 yards | \$16.01 |
| 149436 __ | 1 1/2" x 100 yards | \$17.67 |

• minimum order: one roll.



Can be special ordered in additional colours!

CREATE YOUR OWN LOOK

Please allow 4 - 6 weeks
for printed items from
approved art.

Raised Ink Printing

See chart below for ribbon colours.

Pick your own colours for raised print - NO PLATE CHARGE

Available in: 5/8" x 100 yd roll, 7/8" x 100 yd roll, 1-1/2" x 50 yd roll
40 roll minimum for all printed ribbon.

SPECIAL ORDER

Please allow 4 - 6 weeks for shipment.

Contessa Ribbon



Wire-Edge
Single Face Satin

| CODE | SIZE | PRICE/ROLL |
|------------|-------------------|------------|
| 14163 ___ | 1 1/2" x 25 yards | \$18.05 |
| *14164 ___ | 2 1/4" x 25 yards | \$27.08 |

• minimum order: one roll.



* 2-1/4" is only available in 029-White, 260-Scarlet and 810-Ivory.

Encore Ribbon



Wire-Edge

| CODE | SIZE | PRICE/ROLL |
|-----------|-------------------|------------|
| 141650 __ | 5/8" x 25 yards | \$7.58 |
| 141660 __ | 1 1/2" x 25 yards | \$14.46 |
| 141670 __ | 2 1/2" x 25 yards | \$22.01 |

• minimum order: one roll.

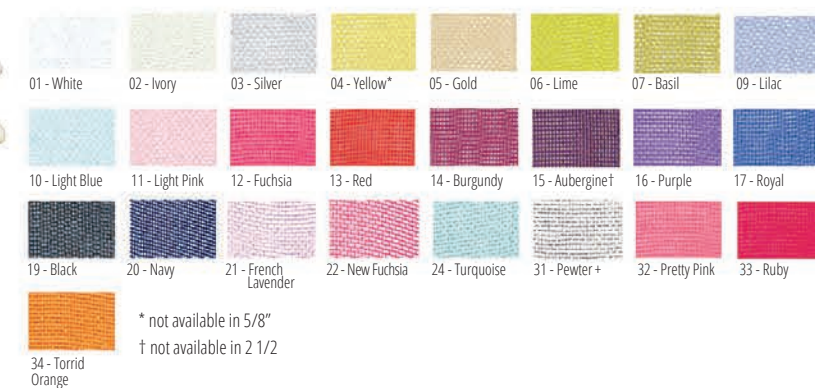

* not available in 5/8"
† not available in 2 1/2"

Garbo Ribbon



| CODE | SIZE | PRICE/ROLL |
|-----------|-------------------|------------|
| 14168 ___ | 5/8" x 100 yards | \$61.13 |
| 14169 ___ | 1 1/2" x 50 yards | \$48.38 |

• minimum order: one roll.



* not available in 5/8"
† not available in 1 1/2"



Sheer Ribbon Colours

All colours are available in all sizes. See page 115 for single face satin and grosgrain colour availability.



Single Face Satin Ribbon with Raised Print



Sheer Ribbon with Raised Print



Grosgrain Ribbon with Raised Print

IN STOCK

IN STOCK

SEALS

SEALS

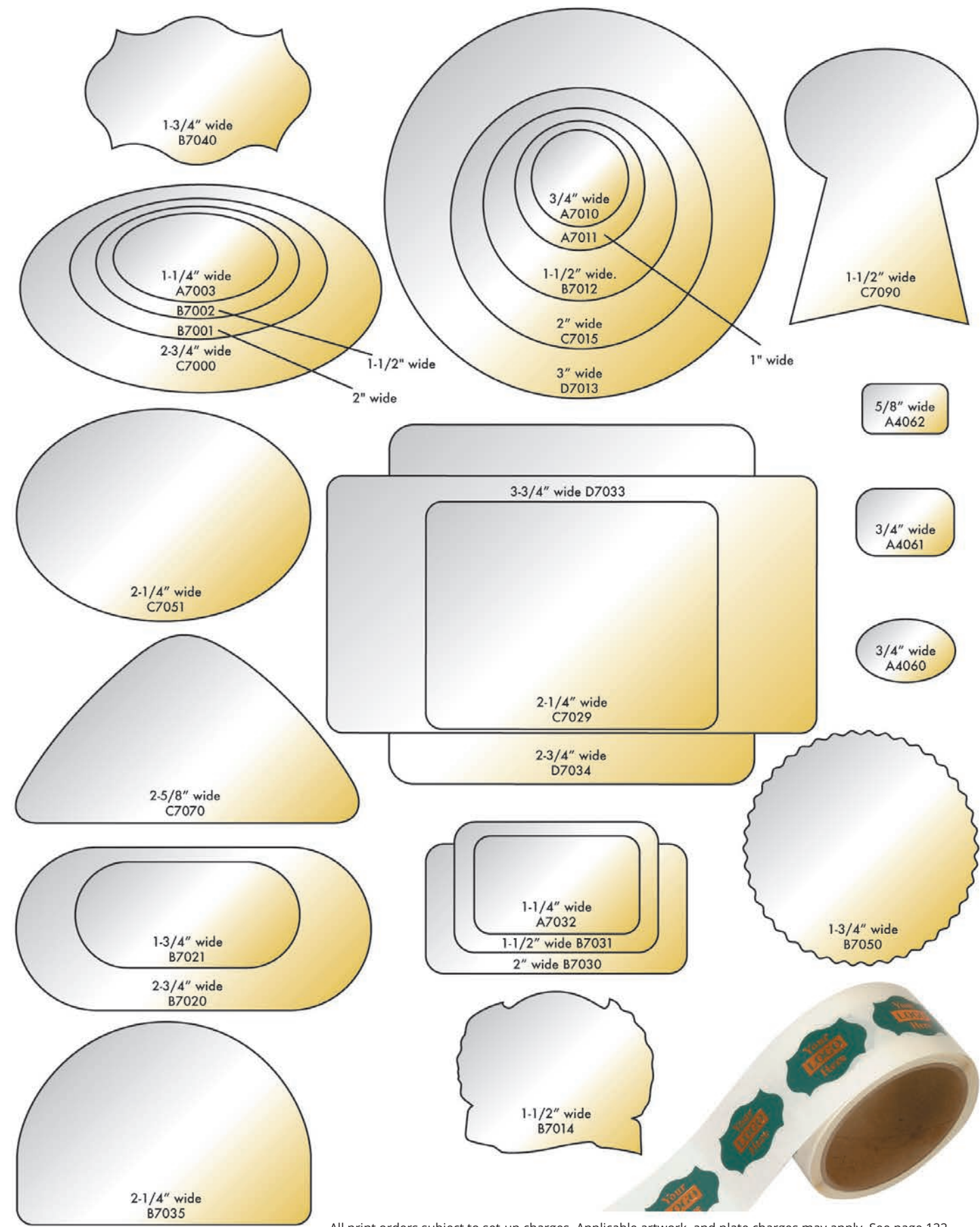

Customized Seals-Foil Printed

| CODE | SIZE | One colour foil print/each | | SPECIAL ORDER Two colour/each | | SPECIAL ORDER Acetate 1 colour/each | | SPECIAL ORDER Acetate 2 colour/each | |
|--|------|----------------------------|--------|-------------------------------|----------|-------------------------------------|----------|-------------------------------------|----------|
| | | 2000+ | 5000+ | 2000+ | 5000+ | 2000+ | 5000+ | 2000+ | 5000+ |
| 25 4 digit label code 2 digit label colour | A | \$0.12 | \$0.10 | \$0.1577 | \$0.1242 | \$0.1792 | \$0.1393 | \$0.2062 | \$0.1598 |
| | B | \$0.13 | \$0.12 | \$0.1685 | \$0.1307 | \$0.2149 | \$0.1685 | \$0.2473 | \$0.1976 |
| | C | \$0.15 | \$0.14 | \$0.1803 | \$0.1501 | \$0.2750 | \$0.1977 | \$0.2894 | \$0.2354 |
| | D* | \$0.17 | \$0.15 | \$0.1922 | \$0.1598 | \$0.3175 | \$0.2538 | \$0.3424 | \$0.2743 |

\$80 plate charge

NO PLATE CHARGES



FOIL PRINT
Included in the price.
Please allow 2-3 weeks for printing.

Label Colours Available:

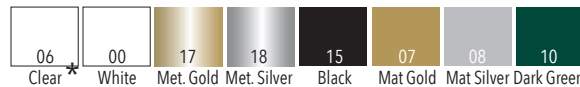

* D sized Seals and Clear print are SPECIAL ORDER.
See foil chart on inside back cover of catalogue for available print colours.

Pre-printed Labels



| CODE | SIZE | CASE | PRICE/EACH | |
|-----------|------------|------|------------|--------|
| | | | 1000+ | 5000+ |
| 25401007S | 5/8 x 3/8" | 1000 | \$0.13 | \$0.12 |
| 25401407S | 5/8 x 3/8" | 1000 | \$0.13 | \$0.12 |
| 25406208S | 5/8 x 3/8" | 1000 | \$0.13 | \$0.12 |
| 25401007V | 3/4" oval | 1000 | \$0.13 | \$0.12 |
| 25401407V | 3/4" oval | 1000 | \$0.13 | \$0.12 |
| 25406008V | 3/4" oval | 1000 | \$0.13 | \$0.12 |

1000/box minimum order - 1 box of 1000.

Available for immediate shipment.

Embossed Seals

For a no-print solution, order our in stock embossed seals.

| CODE | SIZE | PRICE/EA |
|-----------------|-----------|----------|
| Gold 08701207 | 1.5" dia. | \$0.09 |
| Silver 08701208 | 1.5" dia. | \$0.09 |

ACTUAL EMBOSSED PATTERN 1.5" DIA.



All print orders subject to set-up charges. Applicable artwork, and plate charges may apply. See page 122.

All print orders subject to set-up charges. Applicable artwork, and plate charges may apply. See page 122.

SPECIAL ORDER

SPECIAL ORDER

CUSTOM FULL COLOUR SEALS

CUSTOM FULL COLOUR SEALS

Custom Full Colour Seals

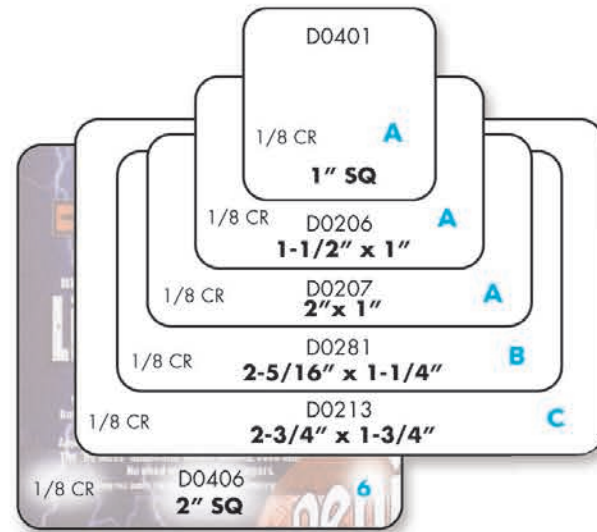
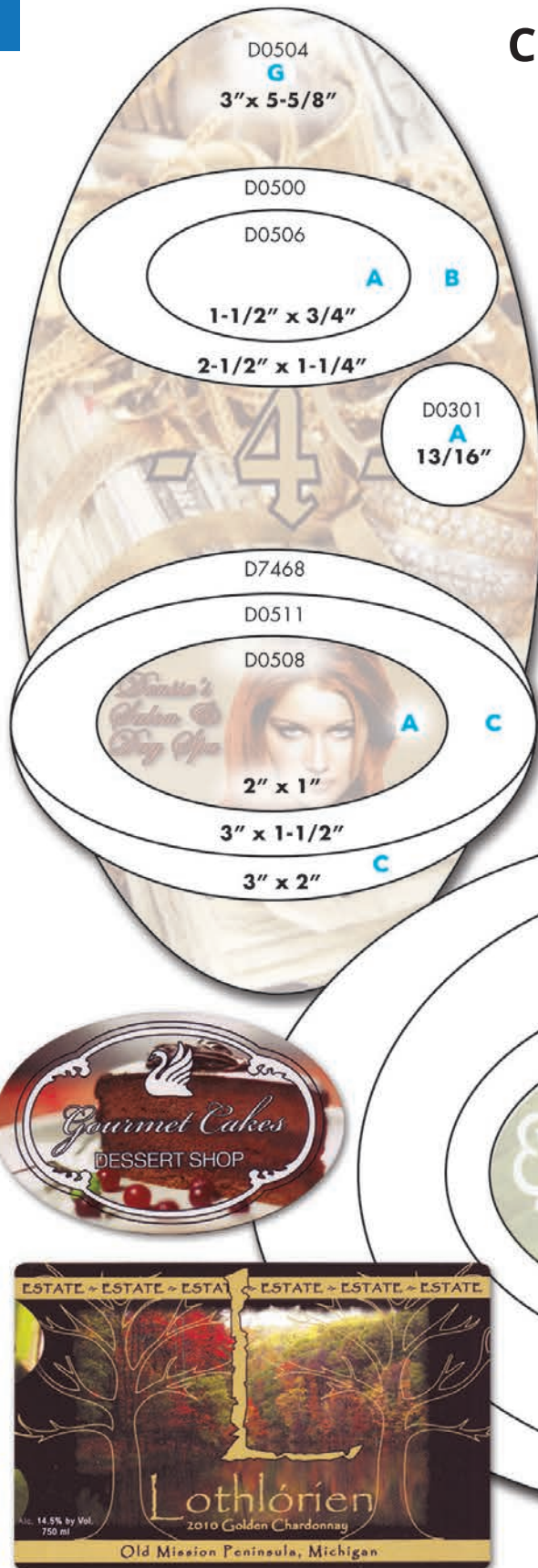

Please allow 4 - 6 weeks for printing from approved art.
NO PLATE CHARGE!

Full colour, edge to edge print.
Thirty sizes to choose from.
"Picture Perfect" Seals

Speak with
your Sales
Representative
to order.

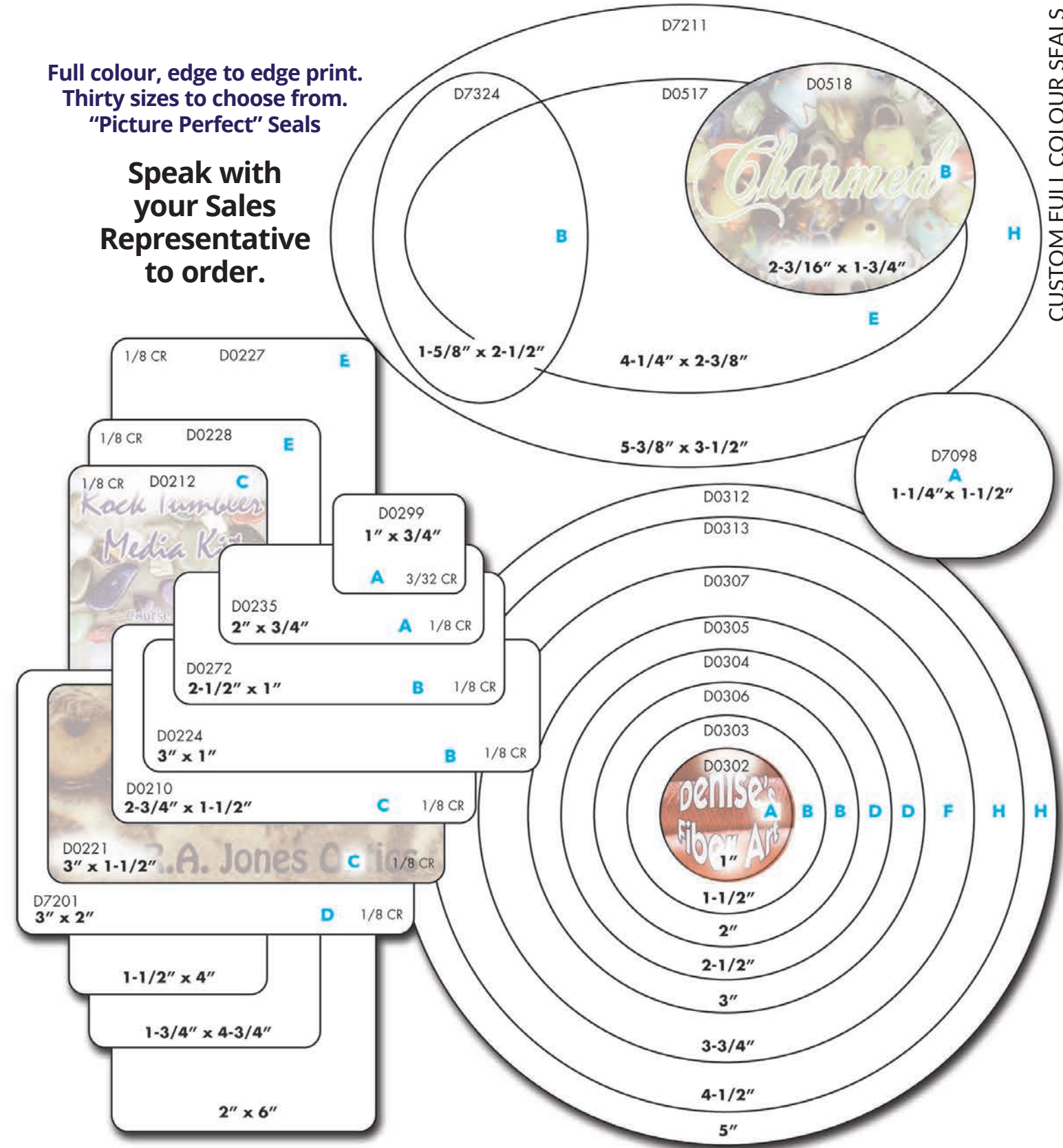





Please allow 4 - 6 weeks for printing from approved art. NO PLATE CHARGE!

PRINTING INFORMATION

Have your name and logo printed... it's easy!

1. Select your box or bag style, colour and size.

2. Choose the printing method you wish to use.

-  A. **FOIL PRINTING:** Foil is applied to the bag or box using a combination of heat and pressure on a magnesium print plate to create an elegant appearance. Choice of Metallic or Matte foils. Cost of Foil Printing Print plate per size and colour - \$80.00 (maximum 30 square inches)
-  B. **PAD PRINTING:** Ink is applied to smooth surfaces allowing us to print your logo in places never before possible. Cost of Pad Print plate per size and colour - \$104.50 (maximum 3.75 square inches)
-  C. **INK PRINTING:** Ink is applied to the box or bag using a rubber printing plate. This method is ideal for larger coverage prints and is economically priced. Cost of Ink Printing Plate per size per colour starting at \$137.50. (maximum 25 square inches)
-  D. **SILK SCREEN:** Die fast ink is applied to Fabric Style Bags through a screen. The process allows the ink to permeate into the fabric dimples for optimal coverage. Screen charge of \$65.00 applies with each order.
-  E. **FULL COLOUR DIGITAL PRINTING:** Utilizing the latest 4-colour process technology, we now offer full colour digital printed graphics on fabric and nylon bags using a heat press process. This full colour digital printing creates a transfer that allows for vibrant images on both lights and darks. Pricing is the same regardless of the amount of colours used in a design. Have your full colour image applied to your bags for just \$2.45 per bag (minimum 300 bags)

3. Choose the Print Colour

When Foil Printing, select from 41 foil colours in 4 different finishes: Metallic (High Sheen or Matte), flat, gloss or pearlized. For ink printing select from our 9 standard colours for in stock items, or ask about Pantone Matching for Special Order items such as Simply Bags and Fabric Style Bags.

4. Send us your artwork.

If you are a new print customer, send us your artwork by e-mail. Artwork must be vector with fonts outlined or high resolution (300 dpi) actual size jpg if vector can not be located.

If you don't have artwork or your artwork needs adjustments, we have a talented design team who can assist you. Contact one of our sales representatives or email us your ideas today. For pricing, see the artwork charges section.

Acceptable Artwork Formats

- Vector files (preferred): Adobe Illustrator with .ai, .eps, or .pdf file extension. If the logo was ever professionally made, at a marketing agency, print shop or sign maker, they will have the logo on file. Check with the original graphic designer. If vector cannot be provided,
- ALL raster formats will be subject to additional art charges as in most cases it will have to be converted to a vector to meet our printers requirements.
- Raster files: (ie. PDF, PSD,TIF, or JPEG) Actual size, high resolution (300dpi or more), is required for all full colour reproduction.
- Please include fonts (.ttf) or convert fonts to outlines when sending ANY Illustrator file, saved as AI, EPS or PDF.

The following formats are NOT acceptable

- Publisher (.pub) • CorelDraw (.cdr) • small GIF or BMP internet images • low resolution JPG
- Any Word or spreadsheet documents - '.docx', '.xls', '.wpd', '.od

If unsure about any format including "what is a vector" please send all inquiries to your inside Customer Service Rep

OTHER PRINTING COSTS

Artwork Charges: As mentioned above, we have a talented creative team that can work with you to design, create, manipulate or re-size your store logo or name. Artwork service is charged at a rate of \$75.00/hour, min. 1/2 hour.

Set-up Charges: Every print job requires a machine to be set-up. A charge will be applied to every order. Foil, Ink, Pad and Digital printing is charged at \$37.00. Silk Screen printing is \$75. Please note: multiple print sizes of the same logo require multiple set-ups.

Plate Charges: Plate charges apply one-time only. Each time you require a 'new' print design (i.e. Logo change, Print Size Adjustment etc.) a new plate must be created. Once the plate is made, we will hold it for you in our warehouse and it will be available for all future printing requirements. Plate charges range in cost from \$80.00 for a Foil Printing plate to \$137.50+ for an Ink Printing Plate. (maximum 25 square inches)

FOIL STAMPING COLOURS

Metallic Options

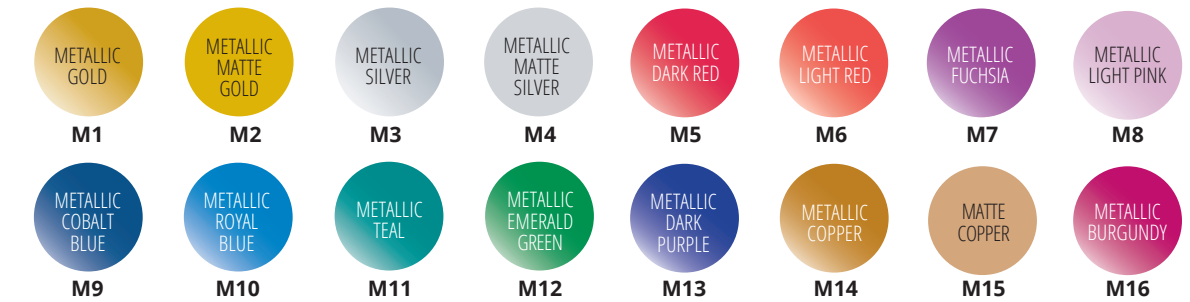

Metallic options feature a high sheen finish unless otherwise indicated as matte finish.

Flat Options



Pearlized Options

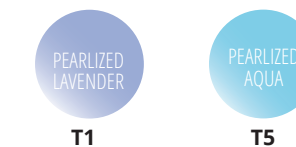

Gloss Options

Gloss Clear - allows the colour of the bag or box to show-through. Gives that tone on tone special highlighted look.



Satine Foil Colours



INK PRINTING COLOURS

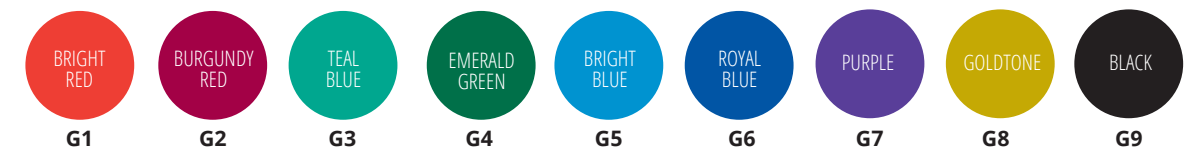

PAD PRINTING COLOURS

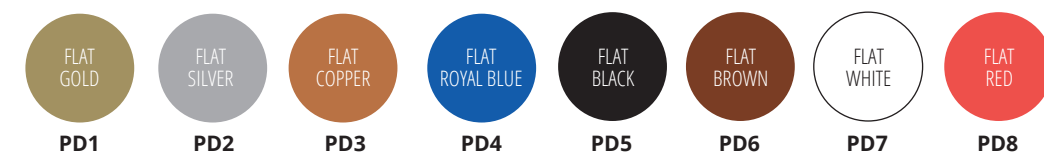

Colours shown are representations only and may not reflect true production colours.



GUNTHERMELE 1857
PACKAGE WITH PURPOSE

PLACE AN ORDER

Call Customer Service: 519.756.4330
Toll Free: 1.888.486.8437
Order on line: gunthermele.com
Direct Fax: 519.756.4335



EASY PAYMENT OPTIONS

- Online at: gunthermele.com and pay with your credit card
- Over the phone, by: Visa or Mastercard
- Via your bank's online bill payment option by selecting "Gunther Mele" as payee
- Contact head office to set up EFT

Sign up for paperless billing. See our website for more information.

Sales Representatives:

British Columbia

JOE BOGDANICH AND
BRENDA TOMASELLA
Cell: 604.561.5444
Email: jbcawest@gunthermele.com

Alberta

DORIS COOPER AND JOHN COOPER
Tel: 403.931.2261
johndoris@jdcooper.ca

Manitoba / Saskatchewan /NW Ontario

MAURA SHALE
Cell: 204-792-8222
Email: mshale@gunthermele.com

Central Northern Ontario

CHRISTY AIKIN
Cell: 705-794-4585
Email: caikin@gunthermele.com

Greater Toronto Area

MICHAEL STEWART
Cell: 416.882.9122
Email: mstewart@gunthermele.com

Toronto

JIM TERESCHUK
Cell: 416.882.3346
Fax: 519.256.1486
Email: jimtereschuk@sympatico.ca

Hamilton / Niagara / Burlington / Oakville

KELLY VANDENBROEK
Cell: 519.670.9574
Email: kvandenbroek@gunthermele.com

Southern Ontario

CINDY MAY
Cell: 416.823.8653
Email: cmay@bell.net
AGOSTINO PORCELLINI
Cell: 416.568.2221
Email: ago@bell.net

Ottawa / Eastern Ontario

JULIA HEW-GUEST
Cell: 289.927.1916
Email: orangebees@gunthermele.com
ANDREW GUEST
Cell: 416.625.6005
Email: orangebees@gunthermele.com

Montreal / Gatineau / Greater Montreal Area

MARIE TOUTONGI
Cell: 514.816.7683
Email: mtoutongi.pkg@videotron.ca

Quebec

MARIE TOUTONGI
Cell: 514.816.7683
Email: mtoutongi.pkg@videotron.ca

Maritimes / Newfoundland & Labrador

MARK AMYOT
Cell: 902.893.1209
Fax: 800.494.5447
Email: forefront@ns.sympatico.ca

TERMS AND CONDITIONS:

- Minimum order \$250.00.
- F.O.B point: Brantford, Ontario Canada.
- Net 30 days O.A.C.
- New account payment terms: Visa or MasterCard 50% deposit with order, balance due upon shipping.
- Defective merchandise will be accepted back for credit only if claimed within 15 days of receipt of shipment. Authorization number must be obtained by contacting our customer service department 1.888.486.8437.
- In-transit damages and shortages must be claimed with the freight carrier at time of delivery.
- All lead times are estimates only (from receipt of approved artwork and credit) and are not guaranteed.
- Plate charges where applicable are:
Foil Print Dies: \$80.00 per size (maximum 30 square inches)
Pad Dies: \$104.50 per size (maximum 3.75 square inches)
Ink Plates \$137.50 (maximum 25 square inches)
- **While we strive for accuracy in our catalogue, actual product may be slightly different than pictured.**
- Prices subject to change without notice.

GUNTHER MELE LTD., 30 Craig Street, Brantford, ON N3R 7J1 Tel: 519.756.4330 Fax: 519.756.4335 Email: packaging@gunthermele.com

GUNTHERMELE.com

03-14-2023