

JEWELLERY PACKAGING GUIDE – WITH GML PRICING
2023 • VOLUME 165





OUR VISION

“Helping our customers tell their unique brand story while providing a customer experience like no other.”

– Darrell King, President

Welcome to our new packaging guide – our 165th version since our founding in 1857. We have some exciting developments in the following pages. Most of the changes we have ushered in this year are centered around a more sustainable approach to our business with an emphasis on the materials we use and the reusability of our products. We have begun to view all of our products through this new lens of eco-minded sustainability. We call this our “**Mission Green**”.

Mission Green drives us to use materials that are either from recycled or sustainable sources. It also focuses us on a vastly overlooked practice in sustainability: reusability.



RECYCLED

There are two important terms that classify the source of recycled content. These are: post-consumer waste and post-industrial waste. Post-consumer waste (PCW). Wherever possible, we are using paper and now plastics that are derived, at least partially if not fully, from municipal recycling programs and this term post-consumer implies that it has been recovered after consumer use. Post-industrial waste (PIW). Another key source of recycled material. In this instance, scrap material is diverted from the landfill and recycled into new material to be used in production. Product Examples include: our brand new, Canadian made paper twist shoppers made from paper that is derived from 96% post-consumer waste. Our new “resuede” is a luxurious recycled material that feels like plush suede but is produced using recycled materials to create a luxury look and feel. We feature our resuede material in our Drawer Series box (page 39) and our Eco Series of hinged boxes (page 27)

SUSTAINABLE

FSC – Forestry Stewardship Council. In short, this governing body oversees wood and pulp (paper) products derived from responsibly managed forests. This global governing body is an intricate certification process that verifies paper and its sources. In the instances where paper needs to come from new pulp source, we are choosing to use papers that carry the widely recognized FSC designation.

REUSABLE

Jewellery packaging has an inherent keepsake quality. Most people will collect jewellery boxes for storage and sentimental value. We have also been studying consumer behavior and there is demand for an after use of jewellery packaging. Our active lifestyles and thirst for travel dictates the need to store and protect jewelry when it is not being worn. With that, we have introduced our new Nano™ collection of luxurious and practical travel pouches that not only present the jewellery exquisitely but also doubles as ongoing storage and protection for our society who is always on the go.

In nearly every category we have exciting new products that meet our Mission Green criteria. These are just the first steps of our journey toward more sustainable and eco-conscious packaging solutions and we hope you’ll join us on this important journey.

TRENDING

ECO CHIC



Signature Velvet Series

Plush black velvet hinged boxes accented with suede pads and bengaline trim detail

See page 17



EcoBox Hinged

50% recycled material plastic shell
resuede interior

See page 27



Drawer Box

100% recyclable paper board with
resuede pads and pulls

See page 39



Deco Box

Recycled paperboard

See page 41



CYOL 6 Easy Pieces Hinged Packaging

with coordinating eurototes

See page 28



All Paper Shopper

100% recyclable / 40% post
consumer waste

See page 79



RPET REUSABLES

Mission Green - sustainable 80% woven
recycled RPET laminated tote

See page 91



Paper Twist

Mission Green - 100% recyclable

See page 85

CYOL

Made to Order Jewellery Display



IN STOCK

Jewellery Display



Platforms and Risers

Ring Showcase

Pendant & Earring Stands

Neck Forms & Bracelet Stands

Trays, Counter Pads,
Chain Ramps

Open Stock and Prepacks
Available

**Save 25% when you buy
\$500 or more!**

Tell your brand story
Create your unique identity

Elevate the
shopping experience

Drive more sales

**Complimentary
Display Design**

Financing Programs Available

*Complete set of renderings available with payment of deposit.
Deposits will be deducted from invoice at time of billing.



PROPOSAL

Ring Presentation



Ring Stash

The solution to bulky engagement ring boxes.

- Discreet compact size
- Flexible ring clip firmly holds the ring in place
- Magnetic closure
- Light weight and durable
- Black sleeve packer
- Printing options available
- U.S. Patent #9375066

68021015L
2.32" x 2.44" x .55
\$22.94/ea. 12/case

Minimum order 12.
Estimated lead time: 2 - 3 weeks for printed items from approved art.

You've sold the perfect ring.
They've planned the perfect moment.
Help them keep it a secret.

 **FOIL / PAD PRINT**
F: inside liner / PP: top lid only
12+ 35c each
144+ 32c each
504+ 26c each

PROPOSAL

Ring Presentation



Proposal Ring Hinged Box

- Single ring box with matching ribbon pull accent and ring clip
- Brushed ivory linea interior
- White sleeve packer
- Minimum case pack 12

36220 _____
2.36" x 2.36" x .94"
\$4.01 each (12+)
\$3.50 each (144+)

Estimated lead time: 2 - 3 weeks for printed items from approved art.

 **FOIL / PAD PRINT**
F: inside top liner
PP: inside top liner and top lid
12+ 35c each
144+ 32c each
504+ 26c each

873B - Bronze



Sweetheart Box

See page 31



Nano Clutch

See page 38



CREATE YOUR OWN LOOK

JEWELLERY PACKAGING



WOOD SERIES

The possibilities are endless when you choose wooden materials. Endless and timeless, in terms of size, shape, finish and colour. High-end style, this collection features our Monterey series shape with a high gloss white finish, black "reveal" edge and black linea interior. Add a matching custom tote bag to complete the look.

IN STOCK

Hinged Boxes

JEWELLERY PACKAGING



**COORDINATING
EUROTOTES**
See pages 77

Available Colours



Outer Box
150MC - Black Gloss



Outer Box
320M - Mahogany



**150MCB -
OPTIONAL
BLACK INTERIOR
RING BOX ONLY**

Monterey II

Wood series with modern lines and a gloss finish.

- Soft white leatherette interior
- Packaged in a 2-piece white traditional outer box

CODE	DESCRIPTION	SIZE (inches)	PRICE/EACH	
			12+	144+
36821	Ring (R1)	2.375 x 2.375 x 2	\$11.79	\$9.63
36822	Earring (E1)	2.375 x 2.375 x 2	\$11.79	\$9.63
36843	Utility T-pad (ET14)	4 x 4 x 2	\$17.80	\$15.81
36850	Watch (PL1)	4.375 x 4.375 x 2.75	\$22.86	\$19.22
36893	Bracelet (BL1)	9.5 x 2.375 x 1.5	\$26.55	\$22.19
36813	Necklace (N2)	7.5 x 7.5 x 2	\$38.22	\$29.54

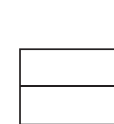

R1
SLOTTED RING PAD

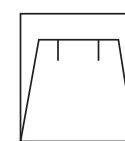

E1
DIE CUT EARRING/PENDANT PAD

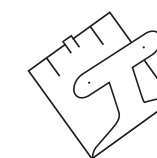

ET14
T FLAP PENDANT/EARRING PAD

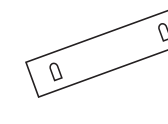

BL1
BRACELET PAD (metal clip)
GLUED PAD

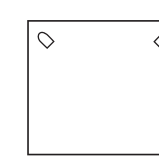

N2
NECKLACE PAD GLUED

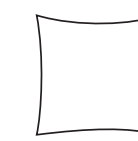

PL1
WATCH PILLOW



FOIL / PAD PRINT

F: inside liner and packer lid / PP: all 3 locations
12+ 35c each
144+ 32c each
504+ 26c each

Minimum 12 per style.
Please allow 2 - 3 weeks for printed items from approved art.

All print orders subject to set-up charges. Applicable artwork, and plate charges may apply. See page 122.

CREATE YOUR OWN LOOK

JEWELLERY PACKAGING



WHISPER SERIES

Our modern luxury box is shown here in a stylish textured gold paper called: Shuttle. Matching interior and pads create a seamless look.

IN STOCK

Hinged Boxes

JEWELLERY PACKAGING



COORDINATING EUROTOTE
See page 78

Available Colours



Outer Box
559W - Carbon Black



Outer Box
009W - Moon Glow



Outer Box
289W - Palladium

Whisper

Elegant curves and round corners.

- Monochromatic metallic pinsketch linea fabric
- Packaged in a coordinating 2-piece outer box

CODE	DESCRIPTION	SIZE (inches)	PRICE/EACH	
			12+	144+
36821	Ring (R1)	2.375 x 2.375 x 2.125	\$8.43	\$7.36
36822	Earring (E1)	2.375 x 2.375 x 2.125	\$8.43	\$7.36
36823	Large Ring (R1)	3.25 x 3.25 x 2.25	\$11.34	\$9.81
36883	Utility T-pad (ET14)	3.25 x 3.25 x 2.25	\$11.34	\$9.81
36850	Watch (PL1)	4 x 4 x 2.75	\$15.32	\$13.34
36893	Bracelet (BL1)	9.25 x 2.5 x 1.75	\$15.12	\$13.20
36873	Necklace (N2)	6.5 x 8 x 1.75	\$23.63	\$19.41

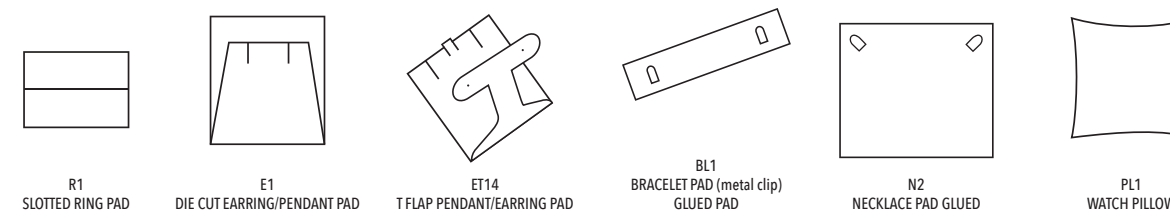

FOIL / PAD PRINT
F: inside liner and packer lid / PP: all 3 locations
12+ 35¢ each
144+ 32¢ each
504+ 26¢ each

Minimum 12 per style.
Please allow 2 - 3 weeks for printed items from approved art.

All print orders subject to set-up charges. Applicable artwork, and plate charges may apply. See page 122.

CREATE YOUR OWN LOOK

JEWELLERY PACKAGING



VELVET SERIES

Plush velvet hinged boxes accented with suede pads and bengaline trim detail.

IN STOCK

Hinged Boxes

JEWELLERY PACKAGING



**COORDINATING
EUROTOTE**
See page 78



Outer Box

Signature Series

This modernized classic is a must have.

- Plush black velvet hinged boxes accented with suede pads and bengaline trim detail
- Packaged in a coordinating 2-piece outer box

CODE	DESCRIPTION	SIZE (inches)	PRICE/EACH	
			12+	144+
36521151	Ring (R1)	1.96 x 1.96 x 1.96	\$9.25	\$8.15
36522151	Pendant/Earring (E1)	2.36 x 2.36 x 2.28	\$11.53	\$9.40
36583151	Utility (PL1 or T3)	3.93 x 3.93 x 2.36	\$12.62	\$11.11
69550151	Pillow (PL1)	fits utility box	\$3.15	\$2.78
69583151	Triple Flip Pad (T3)	fits utility box	\$3.15	\$2.78
36573151	Necklace (N3)	7 x 7 x 1.77	\$20.39	\$17.95

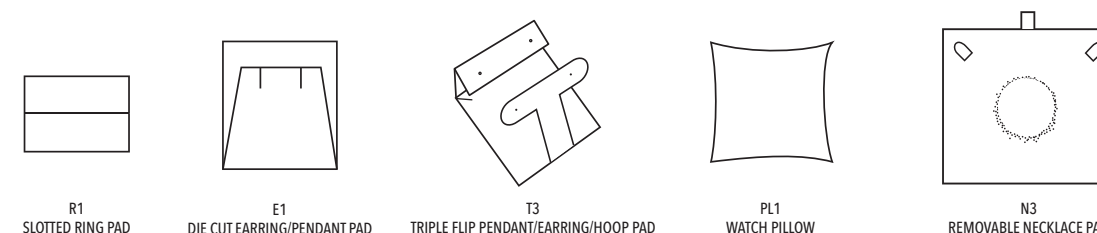

R1 SLOTTED RING PAD E1 DIE CUT EARRING/PENDANT PAD T3 TRIPLE FLIP PENDANT/EARRING/HOOP PAD PL1 WATCH PILLOW N3 REMOVABLE NECKLACE PAD



FOIL / PAD PRINT
F / PP: inside liner and packer lid
12+ 35¢ each
144+ 32¢ each
504+ 26¢ each

Minimum 12 per style.
Please allow 2 - 3 weeks for printed items from approved art.

All print orders subject to set-up charges. Applicable artwork, and plate charges may apply. See page 122.

CREATE YOUR OWN LOOK

JEWELLERY PACKAGING



ECLIPSE SERIES

This eclipse collection features an elegant champagne custom embossed covering with an ivory shimmer interior and gold printed logo on the top liner. The custom rope handle tote completes this beautiful collection.

IN STOCK

Hinged Boxes

JEWELLERY PACKAGING



**COORDINATING
EUROTOTE**
See page 76

Available Colours



Outer Box

813 - Linea Blue Celestial



Outer Box

663 - Linea Aubergine



Outer Box

423 - Brown



50% Recycled Shell

Eclipse

Classic square corners with a distinctive crescent style front.

- Linea Aubergine and Linea Blue Celestial coverings with Ivory Shimmer satin top liners and pads. Packaged in coordinating full-depth 2-piece outer box
- Rich Brown leatherette covering with Champagne satin top liners and sueded pads. Packaged in white full-depth 2-piece outer box

CODE	DESCRIPTION	SIZE (inches)	AUBERGINE AND BLUE PRICE/EACH		BROWN PRICE/EACH	
			12+	144+	12+	144+
36821 ___	Ring (R1)	2.5 x 2.5 x 1.75	\$8.67	\$7.56	\$7.23	\$5.75
36822 ___	Earring/Pendant (E1)	2.5 x 2.5 x 1.75	\$8.67	\$7.56	\$7.23	\$5.75
36883 ___	Utility T-pad (ET14)	3.75 x 4 x 1.75	\$13.02	\$11.55	\$9.53	\$8.15
36893 ___	Bracelet (BL1)	9.25 x 2.5 x 1.75	\$16.41	\$14.42	\$12.15	\$9.94
36873 ___	Necklace (N2)	6.5 x 8 x 1.75	\$26.83	\$22.11	\$23.62	\$19.84
36850 ___	Watch (PL1)	3.75 x 4.25 x 3	\$17.56	\$15.08	\$12.91	\$10.61

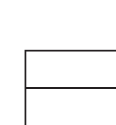

R1
SLOTTED RING PAD

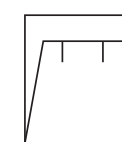

E1
DIE CUT EARRING/PENDANT PAD

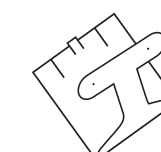

ET14
T FLAP PENDANT/EARRING PAD

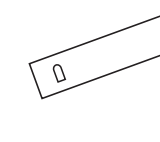

BL1
BRACELET PAD (metal clip)
GLUED PAD

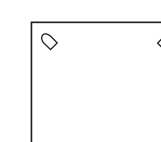

N2
NECKLACE PAD GLUED

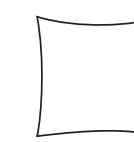

PL1
WATCH PILLOW



FOIL / PAD PRINT

F: inside liner and packer lid / PP: all 3 locations
12+ 35¢ each
144+ 32¢ each
504+ 26¢ each

Minimum 12 per style.
Please allow 2 - 3 weeks for printed items from approved art.

All print orders subject to set-up charges. Applicable artwork, and plate charges may apply. See page 122.

IN STOCK

Hinged Boxes

JEWELLERY PACKAGING



COORDINATING EUROTOTE
See pages 77



Available Colours



Outer Box

114 - Blue

Outer Box

674 - Green

Estate

Contemporary style with a touch of tradition.

- White velvet pads and satin top liners
- Packaged in a coordinating 2-piece outer box

CODE	DESCRIPTION	SIZE (inches)	PRICE/EACH	
			12+	144+
36021	Ring (R1)	2 x 2.25 x 1.875	\$6.74	\$5.34
36022	Earring (E1)	2 x 2.125 x 1.625	\$6.53	\$5.20
36084	Utility T-pad (ET14)	3.5 x 3.5 x 1.5	\$8.45	\$6.88
36093	Bracelet (BL1)	8.5 x 2.125 x 1	\$14.52	\$11.64
36073	Necklace (N2)	7.125 x 4.375 x 1.25	\$20.63	\$16.53



R1
SLOTTED RING PAD

E1
DIE CUT EARRING/PENDANT PAD

ET14
T FLAP PENDANT/EARRING PAD

BL1
BRACELET PAD (metal clip)
GLUED PAD

N2
NECKLACE PAD GLUED



FOIL / PAD PRINT

F: inside liner and packer lid / PP: all 3 locations
12+ 35¢ each
144+ 32¢ each
504+ 26¢ each

Minimum 12 per style.
Please allow 2 - 3 weeks for printed items from approved art.



IN STOCK

Hinged Boxes

JEWELLERY PACKAGING



COORDINATING EUROTOTE
See page 81



OPTIONAL WHITE INTERIOR AVAILABLE
153 - White on Black

OPTIONAL BLACK INTERIOR AVAILABLE
153B - Black on Black



Outer Box

Roma

Distinctive round corner styling with sculpted sides.

- Lizard style embossed covering with leatherette interior
- Packaged in a 2-piece coordinating outer box with ¼ depth lids

CODE	DESCRIPTION	SIZE (inches)	PRICE/EACH	
			12+	144+
36421	Ring (R1)	2.25 x 2.25 x 1.75	\$6.34	\$5.14
36422	Earring (E1)	2.25 x 2.25 x 1.75	\$6.34	\$5.14
36484	Utility T-pad (ET14)	3.75 x 3.75 x 2	\$8.38	\$7.15
36493	Bracelet (BL1)	9.375 x 2.25 x 1.5	\$13.40	\$11.49
36477	Necklace (N3)	7.5 x 7.5 x 2.125	\$23.07	\$19.42



R1
SLOTTED RING PAD

E1
DIE CUT EARRING/PENDANT PAD

ET14
T FLAP PENDANT/EARRING PAD

BL1
BRACELET PAD (metal clip)
GLUED PAD

N3
REMOVABLE NECKLACE PAD



FOIL / PAD PRINT

F: inside liner and packer lid / PP: all 3 locations
12+ 35¢ each
144+ 32¢ each
504+ 26¢ each

Minimum 12 per style.
Please allow 2 - 3 weeks for printed items from approved art.



All print orders subject to set-up charges. Applicable artwork, and plate charges may apply. See page 122.

All print orders subject to set-up charges. Applicable artwork, and plate charges may apply. See page 122.

CREATE YOUR OWN LOOK

JEWELLERY PACKAGING



GEO SERIES

A series completely unique with added top stitching to the covering and upgrading the fabric to a luxurious grey leatherette. This Geo collection features a debossed logo on the top of the lid. Matching dark interior pads create a seamless look to showcase fine pieces. Packaged in two-tone 3/4 depth outer box with a silver embossed print. This collection is completed with coordinating custom rope handle totes.



E-Commerce Jewellery Boxes

Deliver the 'in-store' experience to your customer's door
See page 101 for more information



COORDINATING EUROTOTE

See page 76

415B - Black Packer with Ivory Pouch
456P - Purple Packer with Ivory Pouch
427T - Bronze Packer with Ivory Pouch

Available Colours



873B - Bronze

Outer Box



563P - Purple

Outer Box



153B - Black

Outer Box



083 - Luxe Silver*

Outer Box

Geo

Modern texture in a choice of 4 colour options.

- Ivory brushed leatherette pads and satin top liners
- Packaged in a coordinating 3/4 depth 2-piece outer box

CODE	DESCRIPTION	SIZE (inches)	PRICE/EACH	
			12+	144+
36221	Ring/Earring (R1/E8)	2.375 x 2.375 x 2.375	\$5.76	\$4.72
36283	T-pad Pendant (ET14)	3.5 x 4.5 x 1.5	\$6.85	\$5.92
36293	Bracelet (BL1)	9 x 2.375 x 1.5	\$9.00	\$7.65
36273	Necklace (N2)	7 x 7 x 1.5	\$14.37	\$12.69
36220	Proposal Box* (R2)	2.36 x 2.36 x .94	\$4.01	\$3.50
36224	Lighted Ring/Earring* (R1)	2.36 x 2.36 x 2.36	\$14.47	\$12.69
09030	Pouch with Box*	3 x 4	\$2.77	\$2.35
69221100G	Earring Pad to fit Ring/Earring box (E8)		\$0.98	

* not available in Luxe Silver

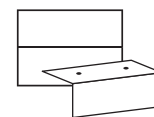

R1 / E8
2-PIECE EARRING /
SLOTTED RING PAD

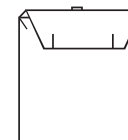

E8
LEVER BACK EARRING PAD

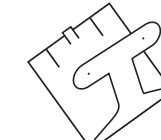

ET14
T FLAP PENDANT/EARRING PAD

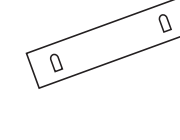

BL1
BRACELET PAD (metal clip)
GLUED PAD

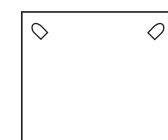

N2
NECKLACE PAD GLUED

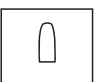

R2
RING CLIP - PROPOSAL PAD



See page 50.



FOIL / PAD PRINT

F: inside liner and packer lid / PP: all 3 locations

12+ 35¢ each
144+ 32¢ each
504+ 26¢ each

Minimum 12 per style.

Please allow 2 - 3 weeks for printed items from approved art.

All print orders subject to set-up charges. Applicable artwork, and plate charges may apply. See page 122.



50% Recycled Shell
and FSC Paper Used

SPECIAL ORDER

Geo Series Boxes and Bags

JEWELLERY PACKAGING



Available in 16 colours
in a selection of 4 luxurious
textured papers.



Shown in Celestial Blue

Shown in Moss

Shown in Brick

Contact your representative for assistance
selecting your texture and colour.

SPECIAL ORDER

Geo Series Boxes and Bags

JEWELLERY PACKAGING

16 Colour Options Available



4 Texture Paper Options Available



Geo Hinged Packaging

- Ivory brushed leatherette pads and satin top liners
- Packaged in a coordinating ¾ depth 2-piece outer box

DESCRIPTION	SIZE (inches)	PRICE/EACH
Ring/Earring	2.375 x 2.375 x 2.375	\$6.84
T-pad Pendant	3.5 x 4.5 x 1.5	\$7.94
Bracelet	9 x 2.375 x 1.5	\$9.03
Necklace	7 x 7 x 1.5	\$13.69
Proposal Box	2.36 x 2.36 x .94	\$5.12

FOIL PRINT - INCLUDED IN PRICE
Inside Top Liner
Packer Lid

Boxes: Minimum 1500 assorted! (min 100 per box)
Bags: Minimum 1000 each size with purchase of 1500 boxes.
Estimated lead time: 12 - 14 weeks for printed items from approved art.

Geo Eurototes

- 110 gsm uncoated paper with 8mm rope handles
- Foil printed two sides

SIZE (inches)	PRICE/EACH
6 x 3.5 x 6 x 3.5	\$1.97
9 x 3.5 x 7 x 3.5	\$2.24
10.5 x 5 x 8.5 x 5	\$2.94

FOIL PRINT
PRINTING INCLUDED IN PRICE

Bags Only: Minimum 3000 each size.
Estimated lead time: 12 - 14 weeks for printed items from approved art.

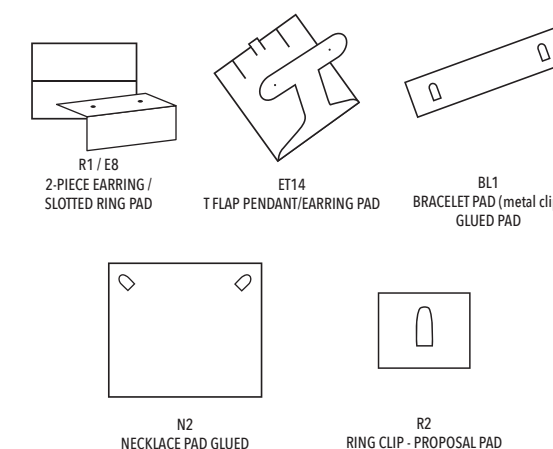

Our Top Selling Collection Just Got Even Better!

Printing included for
any of the items in this program.

Choice of Matte or Metallic Foil Print:
Gold, Silver, Copper or Black.

All print orders subject to set-up charges. Applicable artwork, and plate charges may apply. See page 122.

IN STOCK

Hinged Boxes

IN STOCK

Hinged Boxes

JEWELLERY PACKAGING

JEWELLERY PACKAGING



COORDINATING EUROTOTE
See page 77

COORDINATING ALL PAPER EUROTOTE
See page 79

Palladium Inlay

Stylish contemporary series.

- Palladium grey brushed exterior
- Cream pads and top liner with matching exterior edge
- Packaged in a coordinating 2-piece outer box

CODE	DESCRIPTION	SIZE (inches)	PRICE/EACH	
			12+	144+
36221283P	Ring (R1)	2.25 x 2 x 1.75	\$6.13	\$5.04
36222283P	Earring (E1)	2.25 x 2 x 1.75	\$6.13	\$5.04
36283283P	Utility T-pad (ET14)	3.18 x 4.17 x 1.41	\$8.65	\$7.35
36293283P	Bracelet (BL1)	8.6 x 2.16 x 1	\$9.94	\$8.33
36273283P	Necklace (N2)	6.25 x 4.4 x 1.41	\$11.88	\$10.01



FOIL / PAD PRINT
F: inside liner and packer lid / PP: all 3 locations
12+ 35¢ each
144+ 32¢ each
504+ 26¢ each

Minimum 12 per style.
Please allow 2 - 3 weeks for printed items from approved art.



EcoBox

Modern look inside and out.

- Gunther Mele Mission Green product
- Made with recycled paper exterior
- Made with 50% recycled material plastic shell
- Resuede interior material (49% recycled)

CODE	DESCRIPTION	SIZE (inches)	PRICE/EACH	
			12+	144+
36121000	Ring/Earring (R1)	2 x 2 x 1.5	\$4.69	\$3.98
36163000	T-Pad Pendant/Earring (ET14)	3.75 x 3.75 x 1.33	\$7.54	\$6.41
36193000	Bracelet (BL1)	8.5 x 2 x .91	\$6.64	\$5.64
36173000	Necklace (N3)	7 x 5 x 1.10	\$12.04	\$10.25

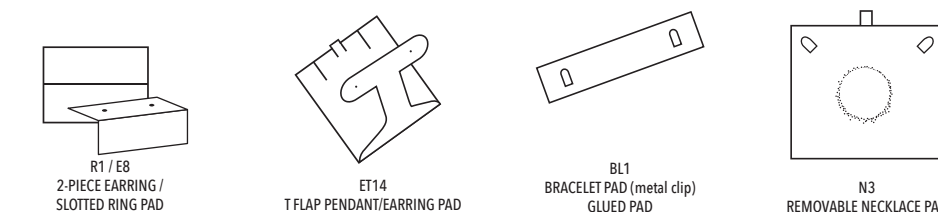

FOIL / PAD PRINT
F: inside liner / PP: top lid
12+ 35¢ each
144+ 32¢ each
504+ 26¢ each

Minimum 12 per style.
Please allow 2 - 3 weeks for printed items from approved art.



50% Recycled Shell

All print orders subject to set-up charges. Applicable artwork, and plate charges may apply. See page 122.

All print orders subject to set-up charges. Applicable artwork, and plate charges may apply. See page 122.

CREATE YOUR OWN LOOK

IN STOCK Hinged Boxes

JEWELLERY PACKAGING

JEWELLERY PACKAGING



COORDINATING EUROTOTE
See below and on page 76

Ring box shown with optional earring pad in place

Available Colours



307 - Gold

308 - Silver

Vantage II

Elegant gold and silver in a linen embossed pattern.

- White satin top liners and leatherette bottom pads
- Packaged in a coordinating 3/4 depth lid 2-piece outer box



CODE	DESCRIPTION	SIZE (inches)	PRICE/EACH	
			12+	144+
36221	Ring/Earring (R1/E8)	2 x 2 x 1.625	\$4.77	\$4.05
36232	T-Pad Pendant (ET14)	2.64 x 2.72 x 2.165	\$5.72	\$4.86
36284	Utility T-pad (ET14)	3.5 x 3.5 x 2	\$6.95	\$5.90
36293	Bracelet (BL1)	8.625 x 2.125 x 1.25	\$9.47	\$8.05
36273	Necklace (N2)	6.25 x 4.5 x 1.5	\$11.90	\$10.11

Minimum 12 per style. Please allow 2 - 3 weeks for printed items from approved art.

FOIL / PAD PRINT
F: inside liner and packer lid / PP: all 3 locations
12+ 35¢ each
144+ 32¢ each
504+ 26¢ each

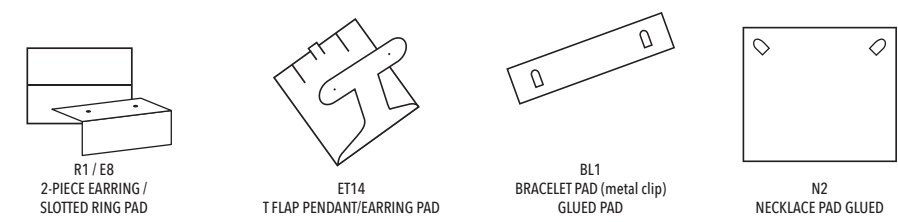

VANTAGE SERIES

6 pieces - 2 boxes + 4 inserts + 9 presentations. A streamlined and customized assortment.

Coordinating Eurototes

- 150 gsm uncoated paper with 8mm paper cord handles
- Minimum 100 per colour

CODE	SIZE (inches)	PRICE/EACH		
		100+	500+	1000+
A 230606	6 x 3.5 x 6 x 3.5	\$1.22	\$1.12	\$0.96
B 231008	10.5 x 5 x 8.5 x 5	\$1.55	\$1.39	\$1.19



07V - Gold

08V - Silver

Estimated lead time: 2 - 3 weeks for printed items from approved art.

FOIL PRINT
100+ 35¢ each
1000+ 32¢ each
2500+ 26¢ each

All print orders subject to set-up charges. Applicable artwork, and plate charges may apply. See page 122.

IN STOCK

Hinged Boxes



COORDINATING EUROTOTE
See page 77



Glitter

Sparkle and shine with this great glittering series.

- White faux-suede pads and satin top liners
- Packaged in a black sleeve

CODE	DESCRIPTION	SIZE (inches)	PRICE/EACH	
			12+	144+
36221183	Ring (R1)	1.75 x 2 x 1.5	\$2.64	\$2.23
36222183	Earring (E1)	1.75 x 2 x 1.5	\$2.64	\$2.23
36284183	Utility T-pad (ET14)	3.5 x 3.5 x 1.25	\$4.45	\$3.69
36293183	Bracelet (BL1)	8.75 x 2.125 x 1	\$5.73	\$4.98
36273183	Necklace (N2)	6.25 x 4.25 x 1.25	\$7.30	\$6.32



FOIL / PAD PRINT
F: inside liner / PP: inside top liner and box lid
12+ 35c each
144+ 32c each
504+ 26c each

Minimum 12 per style.
Please allow 2 - 3 weeks for printed items from approved art.



IN STOCK

Hinged Box



Available Colours



Sweetheart

Show the love with this sweet new velvet vintage inspired ring box.

- Velvet with satin top liner to put a small logo or icon
- Available in soft blush and three jewel tone colours
- Packaged in a 2-piece white outer box

CODE	DESCRIPTION	SIZE (inches)	PRICE/EACH	
			12+	144+
36121 _ _ _	Ring (R1)	1.5 x 1.5 x 1.5	\$6.50	\$3.95

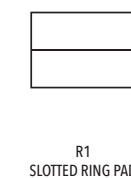

FOIL / PAD PRINT
F: inside liner and packer lid / PP: inside top liner and packer lid
12+ 35c each
144+ 32c each
504+ 26c each

Minimum 12 per style.
Please allow 2 - 3 weeks for printed items from approved art.



IN STOCK

Hinged Boxes

JEWELLERY PACKAGING



COORDINATING EUROTOTE
See page 77



Jewellers Velvet

Lasting traditions.

- Satin top liners
- Packaged in a white 2-piece outer box

CODE	DESCRIPTION	SIZE (inches)	PRICE/EACH	
			12+	144+
36121 ___	Ring (R1)	2 x 2.125 x 1.5	\$3.51	\$2.73
36141 ___	Large Ring (R2)	2.5 x 2 x 1.5	\$4.11	\$3.19
36122 ___	Earring (E2)	2 x 2.125 x 1.5	\$3.51	\$2.73
36132 ___	Utility T-pad (ET14)	2.5 x 2.5 x 1.25	\$4.24	\$3.32
36163 ___	Pendant (E1)	2.25 x 3 x 1.125	\$4.73	\$3.56
36183 ___	Utility (EP4)	3.5 x 3.375 x 1.5	\$6.51	\$5.12
36193 ___	Bracelet (BL1)	8 x 2 x 1.25	\$7.22	\$5.60
36173 ___	Necklace (N2)	7 x 4.25 x 1.5	\$11.03	\$8.73

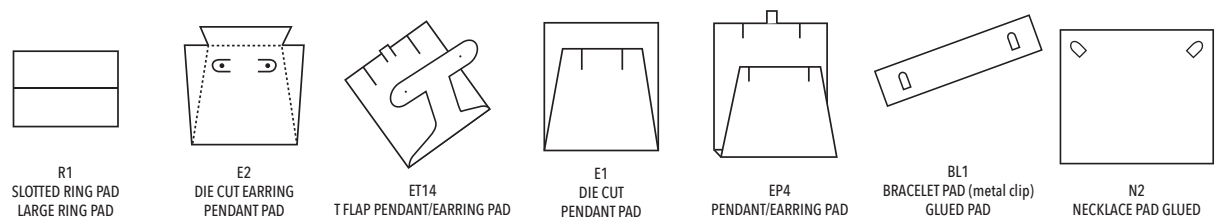

FOIL / PAD PRINT

F: inside liner and packer lid / PP: inside top liner and packer lid
12+ 35¢ each
144+ 32¢ each
504+ 26¢ each

Minimum 12 per style.
Please allow 2 - 3 weeks for printed items from approved art.

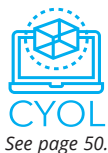

IN STOCK

Hinged Boxes

JEWELLERY PACKAGING



COORDINATING EUROTOTE
See page 77



Econoline

Lasting traditions in blue.

- Blue velour exterior
- Matching interior with white satin
- Arrives in protective white sleeve
- Optional white gloss packer

CODE	DESCRIPTION	SIZE (inches)	PRICE /EACH		2-PIECE CONTAINER PRICE /EACH	
			12+	144+	31	003
36121119	Ring (R1)	1.875 x 2.125 x 1.375	\$2.61	\$2.04	121	\$0.84
36141119	Large Ring (R1)	2.375 x 2 x 1.5	\$2.94	\$2.33	141	\$0.89
36122119	Earring (E2)	1.875 x 2.125 x 1.375	\$2.61	\$2.04	121	\$0.84
36163119	Pendant (E1)	2.25 x 3 x 1.125	\$3.27	\$2.57	163	\$0.93
36132119	T-pad Pendant (ET14)	2.5 x 2.5 x 1.25	\$3.46	\$2.72	132	\$0.92
36193119	Bracelet (BL1)	8 x 2.125 x 1	\$6.23	\$4.87	193	\$1.17
36173119	Necklace (N2)	7 x 4.25 x 1.375	\$8.58	\$6.69	173	\$1.68
36183119	Utility (EP4)	3.875 x 3.25 x 1.375	\$5.99	\$4.68	183	\$1.27
69221000B	Bead Pad for earring box		\$0.68	\$0.56	—	—



Bead Pad

- pad fits stud earring box
- ribbon threads through bead
- ribbon wraps to back and is held by clip

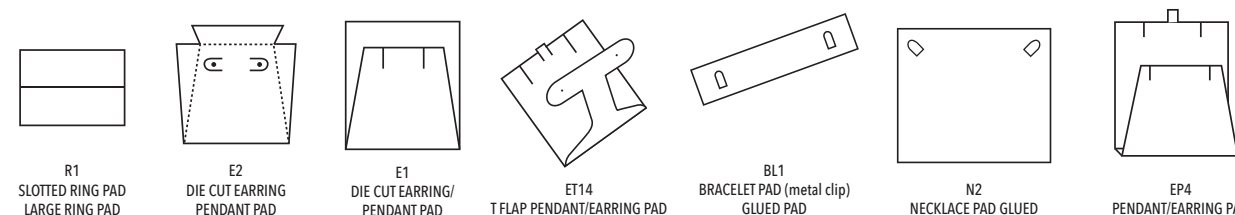

FOIL / PAD PRINT

F: inside liner and packer lid / PP: inside top liner and packer lid
12+ 35¢ each
144+ 32¢ each
504+ 26¢ each

Minimum 12 per style.
Please allow 2 - 3 weeks for printed items from approved art.



All print orders subject to set-up charges. Applicable artwork, and plate charges may apply. See page 122.

All print orders subject to set-up charges. Applicable artwork, and plate charges may apply. See page 122.

IN STOCK

Hinged Boxes

IN STOCK

Hinged Boxes



COORDINATING EUROTOTE
See page 77



COORDINATING EUROTOTE
See page 77

Elan

Timeless classic in all white.

- Soft, white leatherette covering
- Coordinating leatherette pads and white satin top liners
- Packaged in a white traditional 2-piece outer box



Outer Box

CODE	DESCRIPTION	SIZE (inches)	PRICE/EACH	
			12+	144+
36021002	Ring (R1)	2 x 2.25 x 1.625	\$5.07	\$3.60
36041002	Large Ring (R1)	3 x 2 x 1.5	\$7.45	\$5.07
36022002	Earring (E1)	2 x 2.25 x 1.5	\$5.07	\$3.60
36084002	Utility T-pad (ET14)	3.5 x 3.5 x 1.375	\$7.73	\$5.44
36093002	Bracelet (BL1)	8.625 x 2.25 x 1	\$11.79	\$8.00
36073002	Necklace (N2)	7.125 x 4.375 x 1.25	\$14.63	\$9.85



R1 SLOTTED RING PAD LARGE RING PAD
E1 DIE CUT EARRING/PENDANT PAD
ET14 T FLAP PENDANT/EARRING PAD
BL1 BRACELET PAD (metal clip) GLUED PAD
N2 NECKLACE PAD GLUED

FOIL / PAD PRINT
F: inside liner and packer lid / PP: all 3 locations
12+ 35¢ each
144+ 32¢ each
504+ 26¢ each

Minimum 12 per style.
Please allow 2 - 3 weeks for printed items from approved art.



See page 50.

Econolux

Style meets value.

- Soft, white leatherette covering
- White suedine pads and satin top liners
- Packaged in a white tuck outer box (2-piece traditional outer box available)

ADDITIONAL CHARGE FOR OPTIONAL 2-PIECE OUTER BOX



Outer Sleeve

CODE	DESCRIPTION	SIZE (inches)	PRICE / EACH		2-PIECE CONTAINER PRICE / EACH	
			12+	144+	31 ___ 003	003
36121002	Ring (R1)	1.875 x 2.125 x 1.375	\$2.93	\$2.05	121	\$0.84
36141002	Large Ring (R1)	2.375 x 2 x 1.5	\$3.31	\$2.31	141	\$0.89
36122002	Earring (E2)	1.875 x 2.125 x 1.375	\$2.93	\$2.05	121	\$0.84
36163002	Pendant (E1)	2.25 x 3 x 1.125	\$3.53	\$2.72	163	\$0.93
36132002	T-pad Pendant (ET14)	2.5 x 2.5 x 1.25	\$3.30	\$2.69	132	\$0.92
36193002	Bracelet (BL1)	8 x 2.125 x 1	\$6.58	\$5.15	193	\$1.17
36173002	Necklace (N2)	7 x 4.25 x 1.375	\$9.06	\$6.80	173	\$1.68
36183002	Utility (EP4)	3.875 x 3.25 x 1.375	\$6.36	\$4.44	183	\$1.27
69221000B	Bead Pad for earring box		\$0.68	\$0.56	—	—



Bead Pad

- pad fits stud earring box
- ribbon threads through bead
- ribbon wraps to back and is held by clip

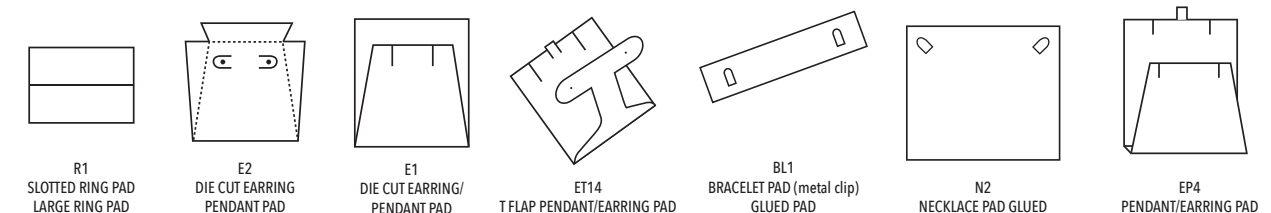

R1 SLOTTED RING PAD LARGE RING PAD
E2 DIE CUT EARRING PENDANT PAD
E1 DIE CUT EARRING/PENDANT PAD
ET14 T FLAP PENDANT/EARRING PAD
BL1 BRACELET PAD (metal clip) GLUED PAD
N2 NECKLACE PAD GLUED
EP4 PENDANT/EARRING PAD

FOIL / PAD PRINT
F: inside liner and packer lid / PP: all 3 locations
12+ 35¢ each
144+ 32¢ each
504+ 26¢ each

Minimum 12 per style.
Please allow 2 - 3 weeks for printed items from approved art.



See page 50.

IN STOCK

Hinged Boxes

Deliver the 'in-store' experience to your customer's door.
See page 101 for more information

COORDINATING EUROTOTE
See page 77



Gold Galleria

A new gold standard.

- White velour pads and satin top liners
- Packaged in a white traditional 2-piece outer box

CODE	DESCRIPTION	SIZE (inches)	PRICE/EACH
36621073	Ring (R1)	2.125 x 2 x 2	\$2.15
36622073	Earring (E1)	2.125 x 2 x 2	N/A
36641073	Large Ring (R1)	3 x 2 x 2	N/A
36684073	Utility T-pad (ET14)	3.5 x 3.5 x 1.5	\$3.05
36693073	Bracelet (BL1)	8.25 x 2.125 x 1.25	\$4.70
36673073	Necklace (N2)	6.25 x 5 x 1.5	N/A
36650073	Bangle (R1)	1.25 x 3.75 x 3.125	N/A
69621000B	Bead Pad for earring box		\$0.68

E-Commerce Jewellery Boxes



E-Commerce Jewellery Boxes



Deliver the 'in-store' experience to your customer's door.
See page 101 for more information

COORDINATING EUROTOTE
See page 77



153B - Black Interior

Horizon

The gold standard in a classic white, burgundy and black.

- White velour pads and satin top liners
- Packaged in a white traditional 2-piece outer box

IN STOCK

Hinged Boxes

Available Colours



003 - White
Outer Box

663 - Burgundy
Outer Box

153 - Black
Outer Box



Outer Box



Bead Pad

- pad fits stud earring box
- ribbon threads through bead
- ribbon wraps to back and is held by clip



Bead Pad

- pad fits stud earring box
- ribbon threads through bead
- ribbon wraps to back and is held by clip

CODE	DESCRIPTION	SIZE (inches)	12+	144+
36621 ___	Ring (R1)	2.125 x 2 x 2	\$3.74	\$2.91
36622 ___	Earring (E1)	2.125 x 2 x 2	\$3.74	\$2.91
36641 ___	Large Ring (R1)	3 x 2 x 2	\$4.27	\$3.47
36684 ___	Utility T-pad (ET14)	3.5 x 3.5 x 1.5	\$5.38	\$4.31
36632 ___	T-Pad Pendant (ET14)	2.75 x 2.75 x 1.375	\$5.33	\$4.17
36693 ___	Bracelet (BL1)	8.25 x 2.125 x 1.25	\$7.03	\$5.72
36673 ___	Necklace (N2)	6.25 x 5 x 1.5	\$11.03	\$8.66
36650 ___	Bangle (R1)	1 x 3.75 x 3.125	\$4.59	\$3.95
69621000B	Bead Pad for earring box		\$0.68	\$0.68
BLACK PADS AVAILABLE (3 SIZES)				
36621153B	Single Ring Pad (black)	2.125 X 2	box w/pad	\$3.74 \$2.91
69622153B	Stud Earring Pad (black)	2.125 x 2	pad only	\$0.34 \$0.34
69633153B	Pend/Earring Pad (black)	2.75 x 2.75	pad only	\$1.09 \$1.09



FOIL / PAD PRINT

F: inside liner and packer lid / PP: all 3 locations
12+ 35¢ each
144+ 32¢ each
504+ 26¢ each

Minimum 12 per style.
Please allow 2 - 3 weeks for printed items from approved art.



See page 50.



FOIL / PAD PRINT

F: inside liner and packer lid / PP: all 3 locations
12+ 35¢ each
144+ 32¢ each
504+ 26¢ each

Minimum 12 per style.
Please allow 2 - 3 weeks for printed items from approved art.



See page 50.

IN STOCK

Jewellery Packaging



Available Colours



Nano Clutch

Perfect for gifting and on the go, this collection is going places!

- Linea envelope, and pad
- Packaged in a 2-piece matching outer box

CODE	DESCRIPTION	SIZE (inches)	PRICE/EACH	
			12+	144+
09121	Ring (R1)	2.55 X 2.55	\$2.49	\$2.30
09163	Pendant (P3)	4 X 4	\$3.04	\$2.80
09193	Bracelet (BL1R)	9.625 X 3.125	\$4.19	\$3.85
09173	Necklace (N1)	6.625 X 6.625	\$5.72	\$5.27

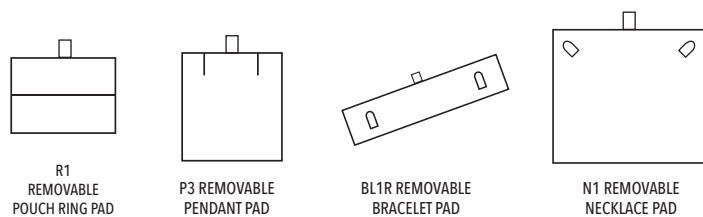

FOIL / PAD PRINT
 F: outside flap and packer / PP: outside flap and packer
 12+ 35¢ each
 144+ 32¢ each
 504+ 26¢ each

Minimum 12 per style.
 Please allow 2 - 3 weeks for printed items from approved art.



IN STOCK

Specialty



The Drawer Box

Eco-friendly, on trend series.



- Removable resuede recycled pads
- Fixed ring pad with foam
- Made with 100% recyclable Paper Board
- Coordinates with the Nano Pouch for a stunning reveal (earring & pendant)

Minimum one case pack.
 Please allow 2 - 3 weeks for printed items from approved art.



CODE	DESCRIPTION	SIZE (inches)	CASE PACK	PRICE/EACH	
				50+	500+
31050603	Ring (R1)	2.24 x 2.36 x 1.98	50	\$2.54	\$2.03
31070703	Earring Utility	2.75 x 2.83 x 1.57	50	\$2.92	\$2.34
31101003	Pendant Utility	3.93 x 4 x 1.57	50	\$3.82	\$3.06

PAD PRINT
 PP: box top
 50+ 35¢ each
 500+ 32¢ each
 2500+ 26¢ each

Vision Box

Unique transparent 3D window box with coordinating display stand.

- Transparent puncture resistant elastic film
- Conforms to hold any jewellery piece
- Coordinating display base (extra)

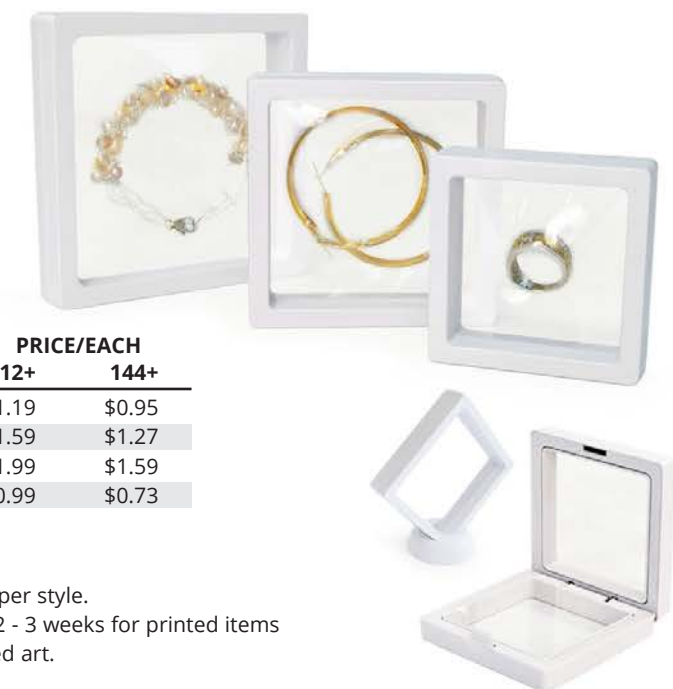

CODE	DESCRIPTION	SIZE (inches)	PRICE/EACH	
			12+	144+
36301103	Small	2.68 x 2.68 x .75	\$1.19	\$0.95
36302103	Medium	3.5 x 3.5 x .75	\$1.59	\$1.27
36303103	Large	4.25 x 4.25 x .75	\$1.99	\$1.59
69300103	Base (pkg of 12)	2.25 x 2.25 x .62	\$0.99	\$0.73

PAD PRINT
 PP: side of lid - text only - limited space
 12+ 35¢ each
 144+ 32¢ each
 504+ 26¢ each

Minimum 12 per style.
 Please allow 2 - 3 weeks for printed items from approved art.

All print orders subject to set-up charges. Applicable artwork, and plate charges may apply. See page 122.

All print orders subject to set-up charges. Applicable artwork, and plate charges may apply. See page 122.

CREATE YOUR OWN LOOK

JEWELLERY PACKAGING



PAPERBOARD SERIES

Stylized lines and the geometric pattern gives this collection an art deco feel.

IN STOCK

Paperboard Hinged

JEWELLERY PACKAGING



**COORDINATING
EUROTOTE**
See page 79



Outer Sleeve



Pads are removable and reversible. Choose white flock or black flock.

Deco

Iconic black and white.

- Paperboard construction, covered in smooth laminate paper
- Flocked reversible black and white foam pads
- Packaged in individual white sleeves

CODE	DESCRIPTION	SIZE (inches)	CASE PACK	PRICE/EACH	
				50+	500+
31621153D	Ring (R1H)	2 x 2 x 1	50	\$1.60	\$1.35
31622153D	Earring (P3)	2 x 2 x 1	50	\$1.60	\$1.35
31632153D	Large Earring (P3)	2.5 x 2.5 x 1.75	50	\$2.08	\$1.76
31684153D	Utility (P2)	3.75 x 3.75 x 1.5	50	\$3.29	\$2.80
31693153D	Bracelet (BL1)	9 x 2 x 1.125	50	\$3.45	\$2.93
31673153D	Necklace (N2)	6.5 x 8 x 2	50	\$7.43	\$6.31



Recycled Paperboard

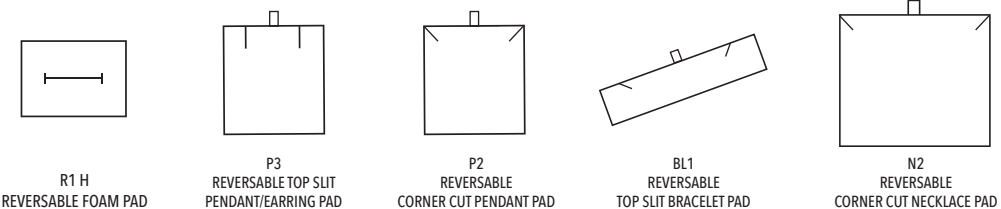

See page 50.

FOIL / PAD PRINT
F: inside and top lid / PP: inside and top lid
50+ 35c each
500+ 32c each
2500+ 26c each

Minimum one case pack.
Please allow 2 - 3 weeks for printed items from approved art.

All print orders subject to set-up charges. Applicable artwork, and plate charges may apply. See page 122.

IN STOCK

2-Piece Boxes

COORDINATING EUROTOTE
See page 76



E-Commerce Jewellery Boxes

Deliver the 'in-store' experience to your customer's door



See page 101 for more information

Available Colours



273 - Bronze



153 - Black

Velocity

Organza ribbon and classic boxes make for perfect partners.

- Texture paper wrapped 2-piece boxes with white flocked foam pads
- Coordinating organza ribbon
- Match with Bronze Geo series and Geo Eurototes

CODE	DESCRIPTION	SIZE (inches)	CASE PACK	PRICE/EACH	
				25+	1000+
31221 ___	Ring (R1)	2.5 x 2.25 x 2	50	\$2.28	\$1.87
31283 ___	Utility (E1)	3 x 3 x 2	50	\$3.15	\$2.61
31293 ___	Bracelet (BL2)	9 x 2.25 x 1.5	25	\$4.33	\$3.56
31273 ___	Necklace (N1)	6.25 x 8 x 2	25	\$5.67	\$4.93

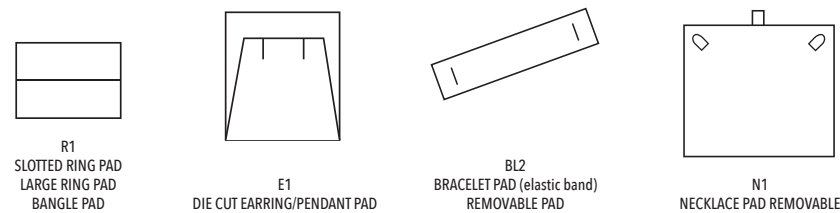

FOIL / PAD PRINT
F: inside and top lid / PP: inside and top lid
25/50+ 35c each
1000+ 32c each
2500+ 26c each

Minimum one case pack.
Please allow 2 - 3 weeks for printed items from approved art.



IN STOCK

2-Piece Boxes

NEW! COORDINATING ALL PAPER EUROTOTE
See page 79



Romance

Perfect partners in ivory and gold.

- Texture paper wrapped 2-piece boxes with white flocked foam pads
- Coordinating organza ribbon
- Match with Cream All Paper Eurototes

CODE	DESCRIPTION	SIZE (inches)	CASE PACK	PRICE/EACH	
				50+	1000+
31221863	Ring (R1)	2.5 x 2.25 x 2	100	\$2.06	\$1.87
31222863	Earring (E1)	2 x 1.5 x 1.187	100	\$1.97	\$1.68
31263863	Utility (P3)	3 x 3 x 2.125	100	\$2.35	\$2.02
31293863	Bracelet (BL1)	9 x 2.375 x 1.5	50	\$3.53	\$2.98
31273863	Necklace (N2)	6.375 x 8 x 2	50	N/A	

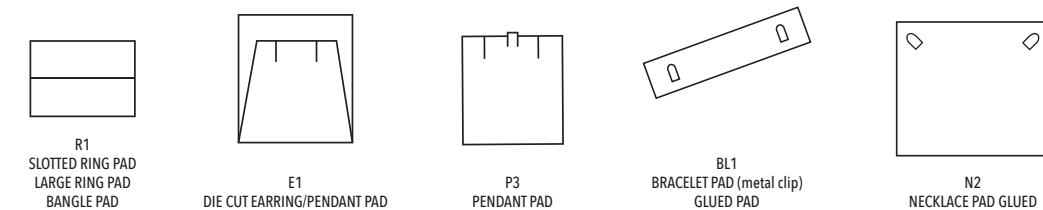

FOIL / PAD PRINT
F: inside and top lid / PP: inside and top lid
50/100+ 35c each
1000+ 32c each
2500+ 26c each

Minimum one case pack.
Please allow 2 - 3 weeks for printed items from approved art.



All print orders subject to set-up charges. Applicable artwork, and plate charges may apply. See page 122.

All print orders subject to set-up charges. Applicable artwork, and plate charges may apply. See page 122.

IN STOCK

2-Piece Boxes



COORDINATING EUROTOTE
See pages 77

Shadow

Shimmery grey exterior, featuring a wave reveal.

- Texture paper wrapped 2-piece boxes with white flocked foam pads
- Match with Rope Handle Eurototes
- No packer/no sleeve

CODE	DESCRIPTION	SIZE (inches)	CASE PACK	PRICE/EACH	
				50+	1000+
31511308	Charm (C1)	2 x 2 x 1	100	\$1.48	\$1.23
31521308	Ring/Earring (R1H)	2 x 2 x 1.75	100	\$1.81	\$1.44
31563308	Pendant/Earring (P2)	3.5 x 3.5 x 1.25	50	N/A	N/A
31593308	Bracelet (BL2)	9 x 2 x 1	50	N/A	N/A
31573308	Necklace (N1)	6 x 6 x 1.5	50	\$5.50	\$4.29

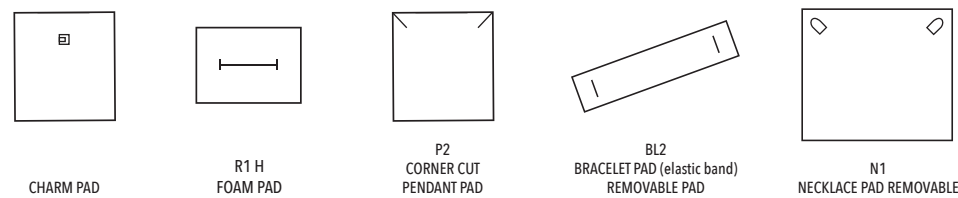

FOIL / PAD PRINT
F: inside and top lid / PP: inside and top lid
50/100+ 35¢ each
1000+ 32¢ each
2500+ 26¢ each

Minimum one case pack.
Please allow 2 - 3 weeks for printed items from approved art.



IN STOCK

Paperboard Hinged



COORDINATING EUROTOTE
See pages 77

Royale

Hinged, white paperboard boxes covered in finely ribbed paper with gold accent lines.

- Texture paper wrapped hinged boxes with white flocked foam pads
- Match with Rope Handle Eurototes
- Packaged in individual white sleeves

CODE	DESCRIPTION	SIZE (inches)	CASE PACK	PRICE/EACH	
				50+	1000+
31545003	Ring/Earring (R1H)	2.5 x 2 x 1.5	100	\$1.43	\$1.30
31533003	Pendant/Earring (P2)	2.75 x 2.75 x 1	100	\$1.70	\$1.50
31560003	Utility (P3)	3.5 x 3.5 x 1	50	\$2.08	\$1.82
31580003	Bracelet (BL2)	8.125 x 2.125 x 1	50	\$2.68	\$2.41
31575003	Necklace (N1)	6.5 x 4.5 x 1	50	\$4.13	\$3.58

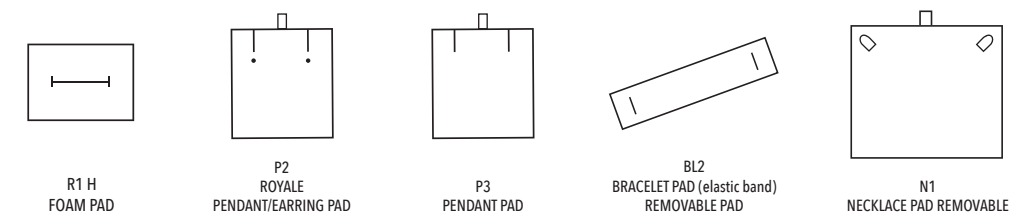

FOIL / PAD PRINT
F: inside and top lid / PP: inside and top lid
50/100+ 35¢ each
1000+ 32¢ each
2500+ 26¢ each

Minimum one case pack.
Please allow 2 - 3 weeks for printed items from approved art.



SPECIAL ORDER

Nest Boxes



100% Recycled Board

Berkeley

Simple yet striking keyline design collection.

- Gloss paper
- Fully customizable
- White flocked platform inserts

Available Colours



849 - Red

192 - Solid White



231 - Black

138 - White



505 - Kraft

CODE	SIZE (inches)	CASE PACK	PRICE/EACH	
			100+	1000+
32201	3 x 3 x 1.25	100	\$1.84	\$1.75
32202	3.5 x 3.5 x 2	100	\$2.79	\$2.64
32203	5 x 5 x 1.5	100	\$3.49	\$3.31
32204	9 x 4.5 x 2*	100	\$4.38	\$4.15

* 849 - Red and 505 - Kraft are not available in this size.

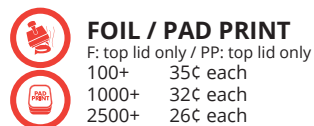

FOIL / PAD PRINT
 F: top lid only / PP: top lid only
 100+ 35¢ each
 1000+ 32¢ each
 2500+ 26¢ each

Minimum one case pack.
 Estimated lead time - Please allow 3 weeks for unprinted items and 4 weeks for printed items from approved art.

SPECIAL ORDER

Nest Boxes



100% Recycled Board



CODE	PRICE /EACH	
	50+	1000+
31011	\$0.93	\$0.84
31021	\$0.99	\$0.90
31032	\$1.17	\$1.06
31033	\$1.39	\$1.26
31036	\$1.56	\$1.42
31034	\$1.70	\$1.14
31053	\$1.62	\$1.47
31065	\$2.27	\$2.06
31082	\$1.53	\$1.39
31085	\$2.89	\$2.63

Cotton Filled Nest Boxes

Mix & Match!

Available Colours



CODE	SIZE (inches)	CASE PACK	061	000K	007	008	009	029	354	353	045	015S	015P	055	093
31011	1.75 x 1.125 x .625	100	✓	✓	✓	✓	-	-	-	-	-	✓	✓	-	-
31021	2.5 x 1.5 x .875	100	✓	✓	✓	✓	✓	✓	✓	✓	✓	✓	✓	✓	✓
31032	3 x 2.125 X 1	100	✓	✓	✓	✓	✓	✓	✓	✓	✓	✓	✓	✓	✓
31033	3.5 x 3.5 x 1	100	✓	✓	✓	✓	✓	✓	✓	✓	✓	✓	✓	✓	✓
31036	3.5 x 3.5 x 1.5	100	-	✓	✓	✓	-	-	-	-	-	-	✓	✓	-
31034	3.5 x 3.5 x 2	100	-	✓	✓	✓	-	-	-	-	-	✓	✓	✓	-
31053	5.25 x 3.75 x .875	100	✓	✓	✓	✓	✓	✓	✓	✓	✓	✓	✓	✓	✓
31065	6 x 5 x 1	50	-	✓	✓	✓	✓	✓	✓	-	✓	✓	✓	✓	✓
31082	8 x 2 x .875	100	-	✓	✓	✓	✓	-	✓	-	-	✓	✓	✓	✓
31085	8 x 5.5 x 1.25	50	✓	✓	✓	-	-	-	-	-	-	-	✓	-	-



CODE	SIZE (inches)	CASE PACK	098	099	060	056	028	025	026	076	075	081	067	019
31011	1.75 x 1.125 x .625	100	-	-	✓	-	-	-	-	✓	✓	-	-	-
31021	2.5 x 1.5 x .875	100	✓	✓	✓	✓	✓	✓	✓	✓	✓	✓	✓	✓
31032	3 x 2.125 X 1	100	✓	✓	✓	✓	✓	✓	✓	✓	✓	✓	✓	✓
31033	3.5 x 3.5 x 1	100	✓	✓	✓	✓	✓	✓	✓	✓	✓	✓	✓	✓
31036	3.5 x 3.5 x 1.5	100	-	-	-	✓	-	-	-	✓	✓	-	-	-
31034	3.5 x 3.5 x 2	100	-	-	-	✓	-	✓	-	✓	✓	-	-	-
31053	5.25 x 3.75 x .875	100	✓	✓	✓	✓	✓	✓	✓	✓	✓	✓	✓	✓
31065	6 x 5 x 1	50	✓	✓	✓	✓	-	✓	✓	✓	✓	✓	-	-
31082	8 x 2 x .875	100	-	✓	✓	✓	-	-	-	✓	✓	-	-	-
31085	8 x 5.5 x 1.25	50	-	-	✓	-	-	-	-	✓	✓	-	-	-



FOIL / PAD PRINT
 F: top lid only / PP: top lid only
 50/100+ 35¢ each
 1000+ 32¢ each
 2500+ 26¢ each

Minimum one case pack.
 Estimated lead time - Please allow 3 weeks for unprinted items and 4 weeks for printed items from approved art.

IN STOCK

Nest Boxes



These boxes match our **Damask Paper Shoppers** - page 85 and **Damask Pouches** - page 54

Damask

Style and substance in a simple packaging combination.

- Black and white 2-piece box
- 100% recycled board box
- Cotton fill pad wrapped with damask patterned tissue
- See our matching bag and pouch to complete your collection

CODE	DESCRIPTION	SIZE (inches)	CASE PACK	100+	1000+
31570153D	Earring	3 x 2.125 x 1	100	\$0.75	\$0.65
31555153D	Brooch	3.5 x 3.5 x 1	100	\$0.89	\$0.76
31564153D	Bracelet	8 x 2 x .875	100	\$1.04	\$0.90
31558153D	Necklace	6 x 5 x 1	100	\$1.51	\$1.28

Minimum order is one case pack.

White Swirl Pattern



White Economy

Sometimes a simple box is all you need!

- Made with 100% recycled board covered with white swirl paper
- Cotton filled to hold jewellery in place

CODE	DESCRIPTION	SIZE (inches)	CASE PACK	50+	1000+
31502103	Charm	2.5 x 1.5 x .875	100	\$0.64	\$0.57
31570103	Earring	3 x 2.125 x 1	100	\$0.72	\$0.60
31555103	Brooch	3.5 x 3.5 x 1	100	\$0.82	\$0.73
31564103	Bracelet	8 x 2 x .875	100	\$0.92	\$0.82
31558103	Necklace	6 x 5 x 1	50	\$1.18	\$1.06
31576103	Large Necklace	8 x 5.5 x 1.25	50	\$1.82	\$1.58
31259103	Stand-Up Bangle	3.5 x 2 x 2 x 2	100	\$2.36	\$2.12

Minimum order is one case pack.



100% Recycled Board



FOIL / PAD PRINT
F: top lid only / PP: top lid only
100+ 35¢ each
1000+ 32¢ each
2500+ 26¢ each

Estimated lead time: 2 - 3 weeks for printed items from approved art.



100% Recycled Board



FOIL / PAD PRINT
F: top lid only / PP: top lid only
50/100+ 35¢ each
1000+ 32¢ each
2500+ 26¢ each

Estimated lead time: 2 - 3 weeks for printed items from approved art.

IN STOCK

Jewellery Folders

15PB - Black

00PW - White



Passport Jewellery Folders

Designed with stylish envelope closure, snaps tight to keep jewels secure.

- Linea exteriors, satin interior
- Packaged in a 2-Piece white outer box
- Two colours soft white and black
- Case pack of 12

CODE	DESCRIPTION	SIZE (inches)	12+	144+
367950	Bracelet	8.25 x 1.75 x 0.625	\$5.62	\$4.78
367900	Necklace/Pearl	6 x 8 x 0.625	\$9.36	\$8.00



FOIL / PAD PRINT

Bracelet: F and PP: inside bottom flap and packer lid
Necklace: PP: top flap / F and PP: inside flap and packer lid
12+ 35¢ each
144+ 32¢ each
504+ 26¢ each

Estimated lead time: 2 - 3 weeks for printed items from approved art.

159W - Black
NO OUTSIDE PRINT

879B - Bronze



009P - Pearl

Global Jewellery Folders

Wide gusset folder for larger pieces.

- Bronze and pearl linea
- Black faux suede
- Satin interior and magnetic closure
- Packaged in a 2-Piece matching outer box
- Case pack of 12

CODE	SIZE (in.)	PRICE / EACH
36790	5.5 x 7.5 x 1.375	\$11.89 \$9.98



FOIL / PAD PRINT

PP: top flap / F and PP: inside flap and packer lid
12+ 35¢ each
144+ 32¢ each
504+ 26¢ each

Estimated lead time: 2 - 3 weeks for printed items from approved art.

Hoop Earring Folder

Black ultrasuede folder with top stitch finish and black interior. Holds hoop earrings up to 2.75" in diameter.

- Packaged in a white 2-Piece outer box
- Case pack of 12

CODE	SIZE (in.)	PRICE / EACH
36791015	4.5 x 4.5	\$4.38 \$3.77



FOIL / PAD PRINT

F: packer lid / PP: packer lid
12+ 35¢ each
144+ 32¢ each
504+ 26¢ each

Estimated lead time: 2 - 3 weeks for printed items from approved art.

All print orders subject to set-up charges. Applicable artwork, and plate charges may apply. See page 122.

All print orders subject to set-up charges. Applicable artwork, and plate charges may apply. See page 122.

CREATE YOUR OWN LOOK

TELL YOUR BRAND STORY CREATE YOUR UNIQUE IDENTITY



Create Your Own Look in 7 Easy Steps

Speak to your sales representative for a consultation.

Looking for 100% custom design? Design your very own jewellery packaging.

STEP 1:

Choose your box style. We have access to endless design and looks. You dream it, we can create it. Choose from wood, plastic, MDF and paperboard shells. Select hinged or 2-piece. MOQ: Plastic or Metal 2,500 Wood 1,000 Paperboard 5,000

STEP 2:

Choose your covering and colour. Leatherette, velvet, paper. Design your texture—hundreds to choose from, or create your own. Brushed leatherette, embossed papers, smooth, textured, Select from our colour books, or use Pantone to specify your exact colours.

STEP 3:

Specify the interior. Select pad colour and material for inside lid. Leatherette, brushed leatherette, flocked, velvet, velour. Decide on the top interior material—leatherette, brushed leatherette, satin, flocked, velvet. Select colour—white, black, ivory are most common. Option—create a reveal with contrasting colour.

STEP 4:

Design your packer. 2-piece box or sleeve. Often you can use the same material or create a coordinating colour. Option -- add die cuts at bottom for ribbon, and/or reveal for contrasting colour.



STEP 5:

Design logo placement. Areas to consider: Inside box lid (Top Satin) Packer Lid (can be centered, or placed at lower corner if using ribbon) Top Lid



STEP 6:

Select your pad designs. (See page 51)

STEP 7:

Email your artwork. Artwork ultimately needs to be in Vector file format. Your graphic designers should be able to assist you. Gunther Mele is also available to provide artwork assistance and full service design, cost is \$75/hour, min half hour charge.

CYOL has 16-20 weeks lead time. (Time frames based on signed approved artwork, quote and deposit). Printing and pre-production samples included at no extra charge.

Please note:

Logos with intricate lines and details (such as diamonds), often will not translate in small print areas, such as top satins. Designs with text and simple outlines work best for inside of ring boxes, etc. Reps and our designers will advise you when artwork should be modified to produce best results.

To ensure accuracy and best quality, signatures are required on all artwork documents and quote documents where noted. Production will not commence until all artwork, quotes and deposits are finalized and signed off. Your rep is available to work with you to ensure all documentation is completed to prevent delays. Please ensure your email access is update date.

Complete your look!

Bags, Tissue, Pouches, Ribbon, Displays, Necklace folders, and more!

Select from our in stock or create your own. Gunther Mele is your one stop for all your needs.

Our sales representative can help you design all your packaging and displays to tell your unique brand story.

CREATE YOUR OWN LOOK

RING PADS

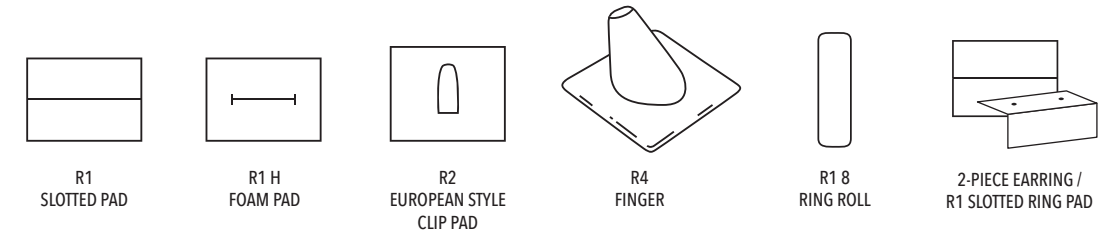

EARRING PADS

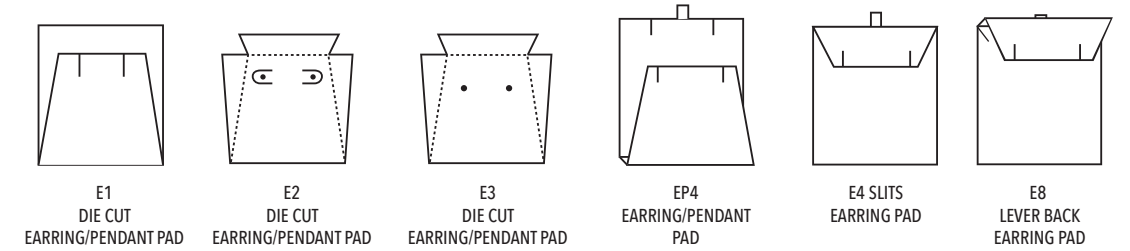

EARRING/PENDANT PADS

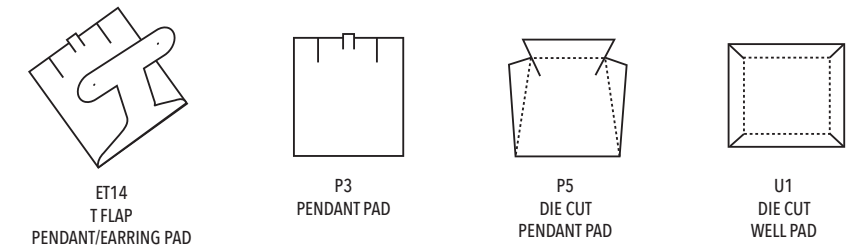

BRACELET AND WATCH PADS

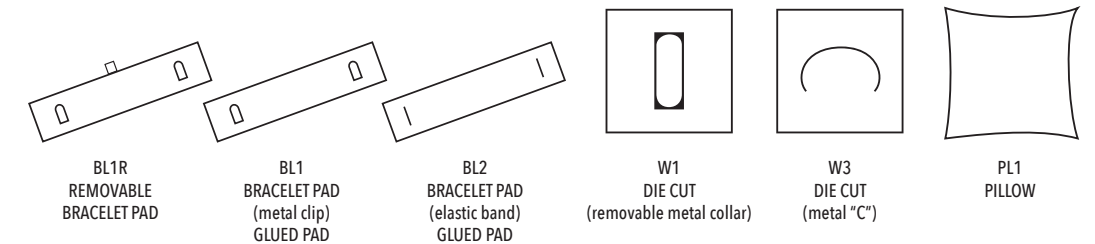

NECKLACE PADS

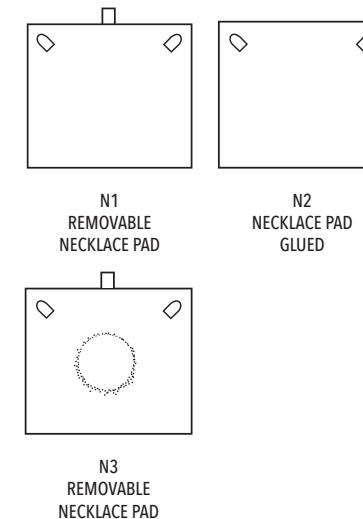

TRIPLE FLIP PADS

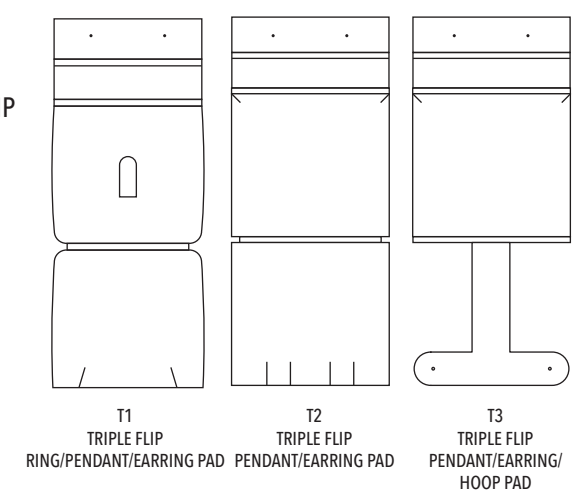

IN STOCK

Pouches

Microfiber Pouches

• Minimum case pack 100

CODE	COLOUR	SIZE (inches)	PRICE /EACH	
			100+	500+
09040315	Black	4 x 3	\$1.26	\$1.11
09050415	Black	5-1/2 x 4	\$1.89	\$1.60
09040311	Blue	4 x 3	\$1.26	\$1.11
09050411	Blue	5-1/2 x 4	\$1.89	\$1.60



IN STOCK

Pouches

Geo Series

• Minimum case pack 12.

Estimated lead time: 2 - 3 weeks for printed items from approved art.



CODE	TYPE	SIZE (in.)	PRICE /EACH	
			12+	144+
A 09030415B	Geo Pouch with Black Box	3 x 4	\$2.77	\$2.35
B 09030456P	Geo Pouch with Purple Box	3 x 4	\$2.77	\$2.35
C 09030427T	Geo Pouch with Bronze Box	3 x 4	\$2.77	\$2.35

FOIL / PAD PRINT
 F and PP: pouch and packer lid
 12+ 35¢ each
 144+ 32¢ each
 504+ 26¢ each

Damask Pouches



Zippered section

Envelope Pouches with snap closure



Available in black. Packaged in a 2-piece, pearlized, dark grey outer box.

Microfiber Bell Pouches +

• Minimum case pack of 12



White Leatherette Pouches



Gold Metallic Pouches



• Minimum case pack of 100

Velveteen Pouches



- Black - 615
- Royal Blue - 611
- Brown - 612
- Green - 667
- Burgundy - 666

**See chart for 2-piece SPECIAL ORDER outer box for the Velveteen pouches.

Wedding Pouches +

White satin pouch with a white 2-piece outer box.

• Minimum case pack 12



SPECIAL ORDER

Natural Jute and Natural Cotton Pouches

• Minimum 100 per size.

Estimated lead time: 6 weeks for printed items from approved art.



Natural Cotton - FOIL PRINT ONLY

CODE	SIZE (in.)	PRICE /EACH	
		100+	1000+
09030400NC	3 x 4	\$0.60	\$0.50
09050600NC	5 x 6	\$0.86	\$0.70
09061000NC	6 x 10	\$1.29	\$1.05
09081200NC	8 x 12	\$1.73	\$1.42

FOIL PRINT
 100+ 32¢ each
 1000+ 29¢ each
 2500+ 24¢ each

Natural Jute - NO PRINT

CODE	SIZE (in.)	PRICE /EACH	
		100+	1000+
09050500NJ	3 x 5 1/2	\$1.12	\$0.92
09050600NJ	5 x 6	\$1.33	\$1.09
09061000NJ	6 x 10	\$1.77	\$1.45

Economical packaging for inexpensive items or repairs.

Estimated lead time: 2 - 3 weeks for printed items from approved art.

FOIL / PAD PRINT
 100+ 35¢ each
 1000+ 32¢ each
 2500+ 26¢ each

+ Bell Pouches and Wedding Pouch minimums:

FOIL / PAD PRINT
 12+ 35¢ each
 144+ 32¢ each
 504+ 26¢ each

Organza Colours (Not exactly as shown.)

Black - 030	Silver - 012	White - 029
Hunter - 589	Navy - 370	Smoke Blue - 337
Lt. Blue - 305	Burgundy - 276	Ultra Violet - 467
Purple - 465	Lavender - 430	Copper - 073
Orange - 750	Olive - 563	Mint - 530
Red - 250	Pink - 115	Gold - 690
Baby Maize - 617	Ivory - 810	Mauve - 161
Pastel Green - 513	Fruit Punch - 155	Yellow - 645
Turquoise - 340	Royal - 350	Fuchsia - 187

A is only available in Silver, White, Pink, Lavender, Gold and Ivory.

F not available in Fruit Punch, Orange, Royal, Turquoise and Yellow.

G is only available in Silver, White, Pink, Red, Burgundy, Lt. Blue, Royal, Lavender, Mint, Olive, Gold and Ivory.

Organza

CODE	SIZE (inches)	PRICE /EACH	
		100+	1000+
A 09905 ___	2 x 2.5	\$0.43	\$0.36
B 09910 ___	3 x 4	\$0.46	\$0.37
C 09915 ___	4 x 5.5	\$0.60	\$0.48
D 09920 ___	5 x 6.5	\$0.69	\$0.56
E 09925 ___	5.5 x 9	\$1.02	\$0.83
F 09930 ___	6 x 14	\$1.19	\$0.97
G 09950 ___	22 x 25 (not shown)	\$3.94	\$3.15

Minimum 100 per size/colour.

Estimated lead time: 6 weeks for printed items from approved art. Foil printed to be determined.

FOIL PRINT - TBD
 100+ 35¢ each
 1000+ 32¢ each
 2500+ 26¢ each



CODE	TYPE	SIZE (in.)	CASE PACK	PRICE/EACH	
				100+	1000+
A 09040515D	Large Damask Pouch	5.5 x 4	100	\$2.87	\$2.35
B 09030315D	Small Damask Pouch	3 x 3	100	\$1.84	\$1.66
C 09304715	Large Envelope Pouch	3 x 4	100	\$2.80	\$2.64
D 09203715	Small Envelope Pouch	2.375 x 2.75	100	\$2.16	\$1.98
E 09525115B	Large Microfiber Bell Pouch	4.375 x 5.3751	12	\$1.46	\$1.25
F 09324115B	Small Microfiber Bell Pouch	3.25 x 4.5	12	\$1.17	\$1.01
G 09314700	Large White Leatherette Pouch	3 x 4	100	\$1.00	\$0.88
H 09203700	Small White Leatherette Pouch	2.75 x 3.25	100	\$0.71	\$0.64
I 09314807	Gold Metallic Pouch	3 x 4	100	\$0.77	\$0.61
J 09405 ___	*Velveteen Pouches	4 x 5.5	100	\$0.97	\$0.65
K 09314 ___	*Velveteen Pouches	3 x 4	100	\$0.80	\$0.54
31314003	White 2-piece outer box**	3.25 x 4.25	100	\$1.34	\$1.22
31065000K	White 2-piece outer box	6 x 5 x 1	50	\$2.27	\$2.06
L 37501006	White Wedding Pouches	1.875 x 2.5	12	\$1.08	\$0.87

* See photo for colour code

All print orders subject to set-up charges. Applicable artwork, and plate charges may apply. See page 122.

All print orders subject to set-up charges. Applicable artwork, and plate charges may apply. See page 122.

IN STOCK

Jewellery Care

Available for immediate shipment.

New



We care about your jewellery as much as you do!

We care about your jewellery, that's why we use better ingredients, better packaging, and you get better performance to keep you sparkling brighter all day long. Use Lavish everyday to safely and conveniently make your jewellery sparkle and shine more than it ever has.



Lavish Jewellery Bath

Jewellery bath includes 1 pod of our jewellery cleaner concentrate. An effective jewellery cleaner that can be used on all jewellery from Pearls and Opals to Diamonds without the risk of damage.

8 fl. oz. (236 ml)
04530000 \$5.93 ea
 50 per case pack



Lavish Polishing Cloth

Gold, Silver, Platinum oh my!

Bring back the shine of all your metals with the Lavish signature polishing cloth. Our polishing cloth is infused with a gentle and effective polishing compound that will bring back the luster and shine to your jewellery. Great for use on gold, silver, platinum, and other precious metals.

Note: To avoid the possibility of small scratches, care should be taken to avoid contact with stones other than diamonds. 8 fl. oz. (236 ml)

6" x 8" - Slate Grey with Vellum Envelope
04540000 \$5.21 ea
 50 per case pack



Handling Gloves

White microfiber. One size fits all
 The natural oils in our skin can often leave displeasing marks on jewellery. Our microfiber, lint-free gloves are ideal for handling and protecting your most precious inventory.

05000296 \$2.95 /pair
 Minimum order - 6 pairs



Lavish Foam

Our Lavish Jewellery Cleaning Foam is our #1 customer favorite product. The foam is a special blend of bio-based surfactants that coalesce in a foam to efficiently break down the daily buildup of grime and allow it to be easy rinsed away leaving nothing but sparkle and shine. The foam is dispensed through a non-aerosol pump foamer, so there are no nasty propellants to damage our ozone layer.

1.69 fl. oz. (50 ml) **04510050** \$6.97 ea
 2.5 fl. oz. (75 ml) **04510075** \$9.13 ea
 48 per case pack per size



Lavish Click Clean Pen

The Lavish Click Clean Pen is the ultra portable, ultra quick way to put the bling back in your ring. The non-toxic formulation is safe for all your jewellery and is ready to go whenever, wherever you are. The one-handed click action gives you control so you can dispense just the right amount of cleaning solution onto your jewellery. The soft brush tip makes it easy to get into hard to reach areas of your jewellery and underneath stones.

.108 fl. oz. (3.2 ml)
04520000 \$7.40 ea
 50 per case pack

SPECIAL ORDER

Estimated lead time: 3-4 weeks for printed items from approved art.

Jewellery Care

New

Customize with your store brand!

Quality professional jewellery care, such as LAVISH, starts as an add-on sale or complimentary gift with purchase and keeps customers coming back for more. Every time customers clean their jewellery with customized LAVISH jewellery care, they will think of your store.



Full Colour Digital Printed Labels

Create your own full colour look or our artist can create a design for your approval. Estimated lead time: 3 - 4 weeks for custom printed items from approved art.



Lavish Jewellery Bath

8 fl. oz. (236 ml)
04530000C \$5.93 ea
 Minimum order 150 jars



Lavish Polishing Cloth

6" x 8" - Slate Grey with Vellum Envelope
04540000C \$5.21 ea

Screen print colours: Black, Silver, Gold or White
 Minimum order 200 cloths



Lavish Foam

1.69 fl. oz. (50 ml) **04510050C** \$6.97 ea
 2.5 fl. oz. (75 ml) **04510075C** \$9.13 ea
 Minimum order 96 bottles per size



Lavish Click Clean Pen

.108 fl. oz. (3.2 ml)
04520000C \$7.40 ea
 Minimum order 100 pens

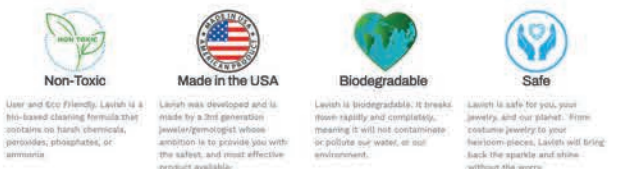

Diamond & Gem Cloths

Microfiber Cloth removes small dust, oily film, fingerprints and other residue from fine jewellery. Chemical Free. Lint Free. AVAILABLE IN LIGHT BLUE ONLY. Estimated lead time: 4 - 6 weeks for custom printed cloths from approved art.

8 x 8" Blue Cloth **04780800C** \$4.89 ea
 Minimum order is 144 cloths.

IN STOCK

Jewellery Care

Estimated lead time: 2 - 3 weeks for printed items from approved art.

Repair Envelopes

 **NO PLATE CHARGES!**

CODE	DESCRIPTION	SIZE (in)	1000	3000	5000	10000
A 09850000	2-Part NCR	4.25 x 9	\$0.41	\$0.37	\$0.32	\$0.26
B 09845200	Plain-no perf., text or numbers	3.5 x 6.125	\$0.15	\$0.14	\$0.12	\$0.10
C 09845300	Double Perforated	3.5 x 6.125	\$0.22	\$0.19	\$0.16	\$0.14
D 09845400	Single Perforated	3.5 x 6.125	\$0.23	\$0.20	\$0.17	\$0.15
E 09850000E	2-part NCR - NO PRINT	4.25 x 9	\$0.18	\$0.15	\$0.13	\$0.11

• Prices include one colour printing. A second colour is \$ 0.029/each.
Minimum 1000 per style. Printing colours: Black, Red, Green and Blue



Please allow 2 - 3 weeks for printing.
\$37 set-up charge applies.

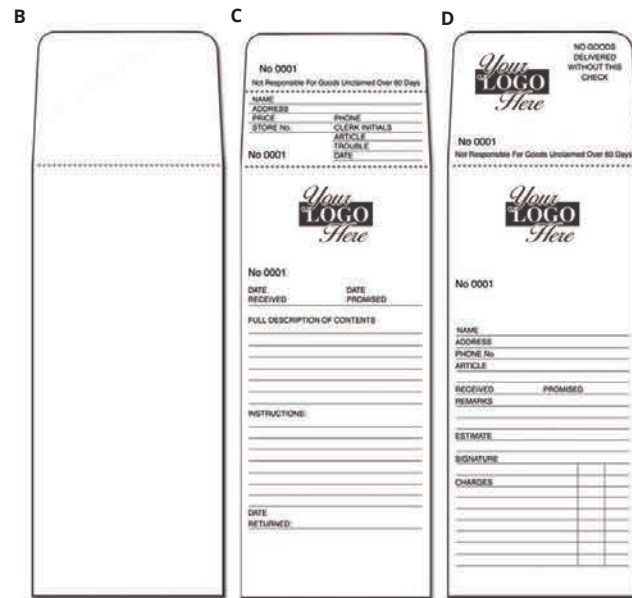

Tags and Miscellaneous Accessories



CODE	DESCRIPTION	PACK MIN.	PRICE
E 08270207	Plastic Ring Tags - Gold	Box/1000	\$123.83
F 08270208	Plastic Ring Tags - Silver	Box/1000	\$123.83
G 08090707	Plastic With String Tags - Gold	Box/1000	\$123.83
H 08090708	Plastic With String Tags - Silver	Box/1000	\$123.83
I 08810800	Super Mylar Ring Tags - Wide	Box/1000	\$48.78
J 08810700	Super Mylar Ring tags - Narrow	Box/1000	\$32.52
08833000	Fine Pen Marker (not shown)	1	\$13.76

Available for immediate shipping for above items.

All print orders subject to set-up charges. Applicable artwork, and plate charges may apply. See page 122.

JEWELLERY DISPLAY



CREATE YOUR OWN LOOK

Step 1: Choose your platforms profile.
These can be made in any size.

Step 2: Choose your elements.
Options: magnetics or hide a tag.

CREATE YOUR OWN LOOK

JEWELLERY DISPLAY

REVEAL
Shown in
Novasuede



WHISPER
Shown in
Novasuede

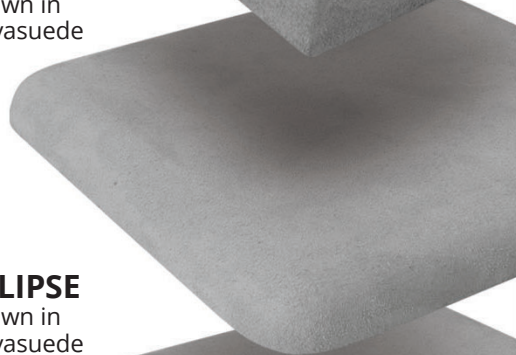

ECLIPSE
Shown in
Novasuede

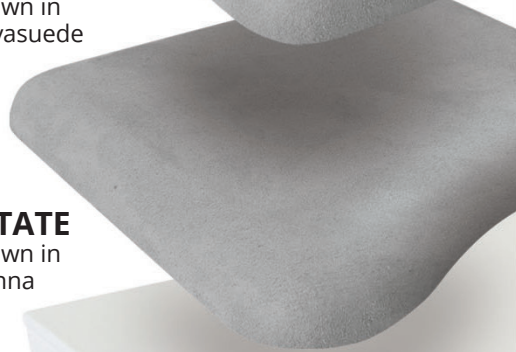

ESTATE
Shown in
Vienna



VANTAGE
Shown in
Vienna

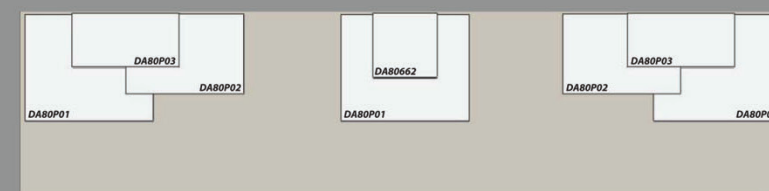
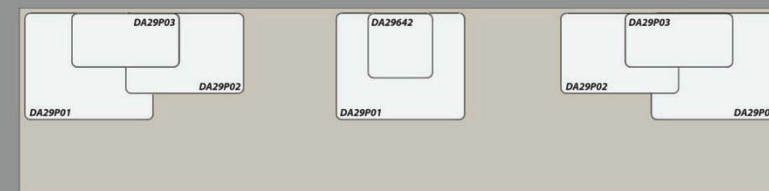
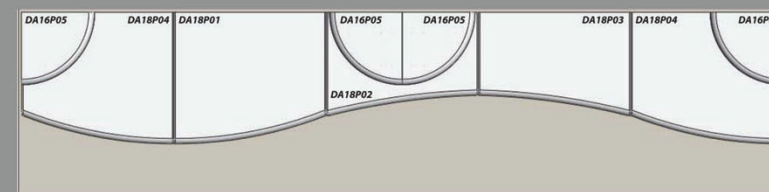
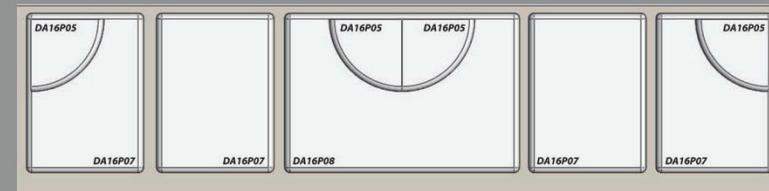
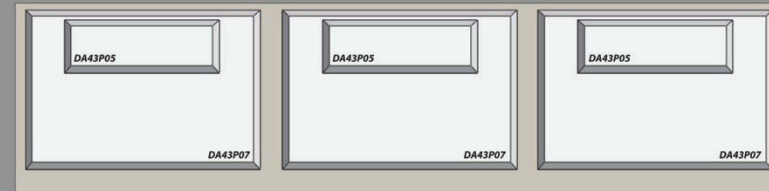

ELEMENT AND SHOWCASE PLATFORM STYLES

Call our experts for assistance.

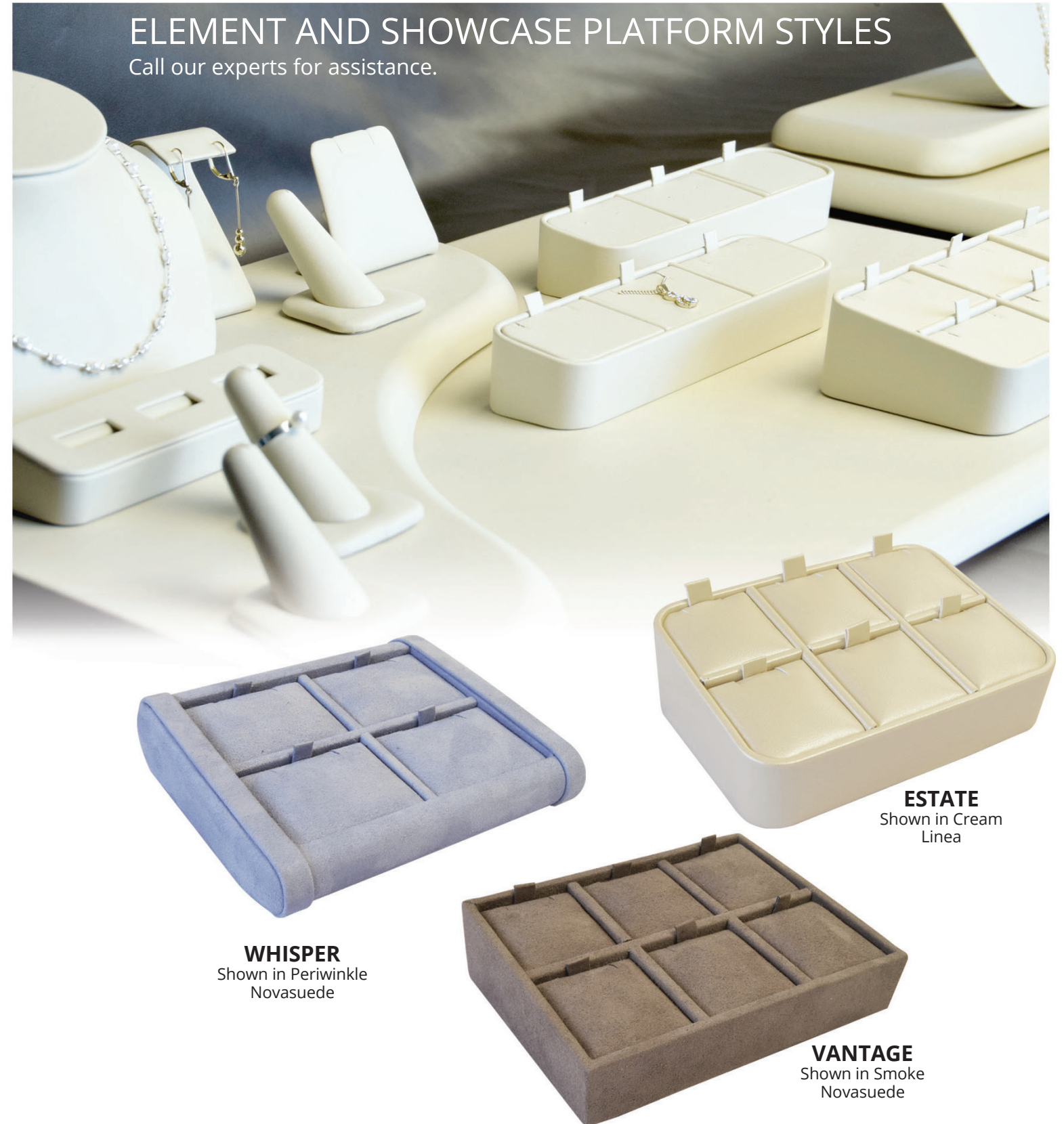

WHISPER
Shown in Periwinkle
Novasuede

ESTATE
Shown in Cream
Linea

VANTAGE
Shown in Smoke
Novasuede

JEWELLERY DISPLAY

CREATE YOUR OWN LOOK

FABRICS & COLOUR CHOICES

CALL OUR EXPERTS FOR ASSISTANCE.

Fabric for Floorboards - Minimum order of 2 yards x 54" wide Cut Yardage Pricing

54"	Vienna	FIF1007936	\$61.00/yard
54"	Linea	FIF1037700	\$71.00/yard
49"	Charisma	FIF1037722	\$81.00/yard
54"	Elite	FIF1037723	\$81.00/yard
54"	Nova	FIF1037724	\$132.00/yard

Cutting Charge:
\$70.00 for any order
under 10 yards.

Lead times 2 - 3 weeks.

CREATE YOUR OWN LOOK

Step 3: Choose your fabric colour and style. Options: metal or wood details.



Elements shown
in Black Vienna
Leatherette

Vienna Leatherette - Group A

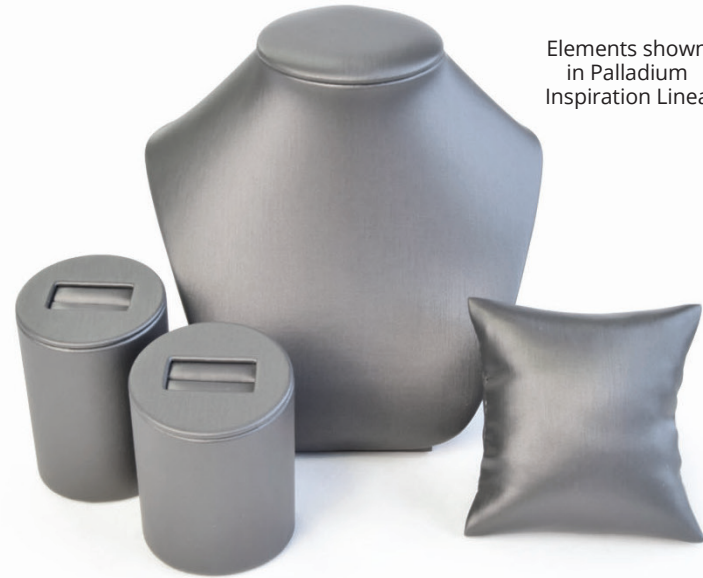

Elements shown
in Palladium
Inspiration Linea

Inspirations Linea - Group B

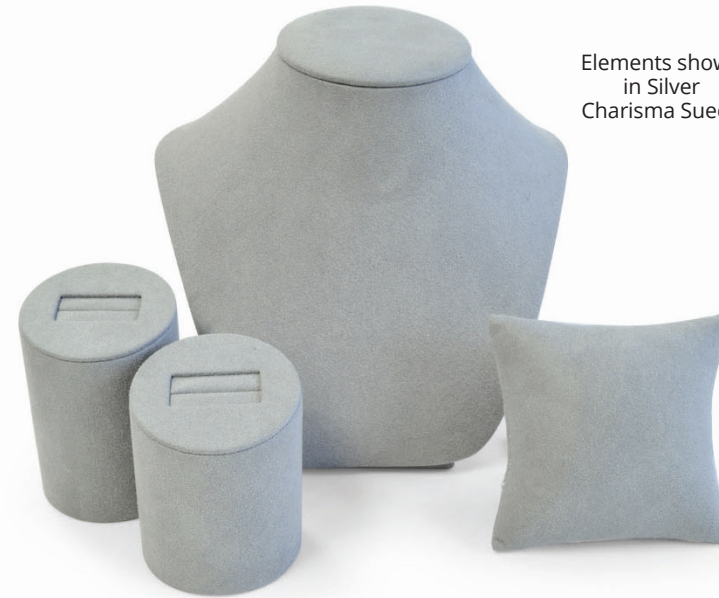

Elements shown
in Silver
Charisma Suede

Charisma Suede - Group B



Elements shown
in Gainsborough
Novasuede

Novasuede - Group C



Chalk Frost Pistachio



Moon Glow Paradiso Pecan Shell



Jade Blue Topaz Mink



Smoke Stone Grey Powder Grey



Mocha Metallic Bronze Copper



Classic Bronze Caponata Sepia



Taupe Silver Butternut



Taupe Beige Buttercup



Black Aubergine Port



Phantom Palladium Carbon



Palomino Fawn Buff



Periwinkle Sky Blue Blue Max

IN STOCK

All our in stock displays are covered in Vienna Chalk fabric.

Ring Showcase Displays

Available for immediate shipment.

Save 25% when you buy \$500 or more!

All our in stock displays are covered in Vienna Chalk fabric.

Available for immediate shipment.

IN STOCK

Pendant/Earring and Mix Showcase Displays

Save 25% when you buy \$500 or more!

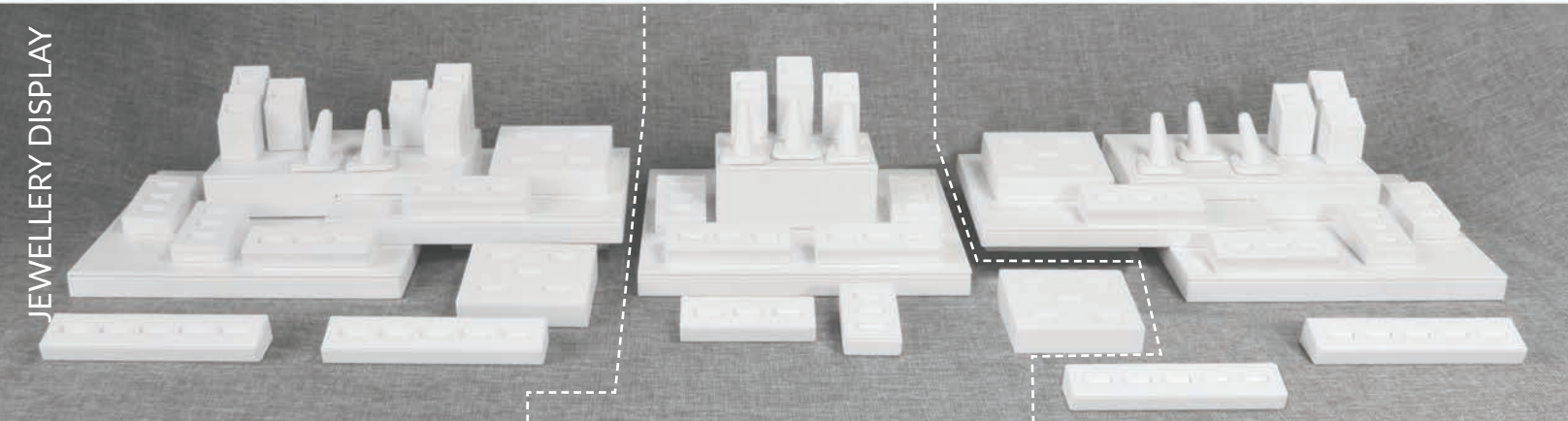

Section 1

16 sku capacity - 40 Rings

\$277.08*

*Platforms not included

Section 2

12 sku capacity - 29 Rings

\$240.14*

*Platforms not included

Section 3

14 sku capacity - 33 Rings

\$218.52*

*Platforms not included

Complete 6 foot - 102 ring element display - \$735.74 **Buy \$500+ \$551.80**

Add all platforms as shown - \$440.37 **Buy \$500+ \$330.28**

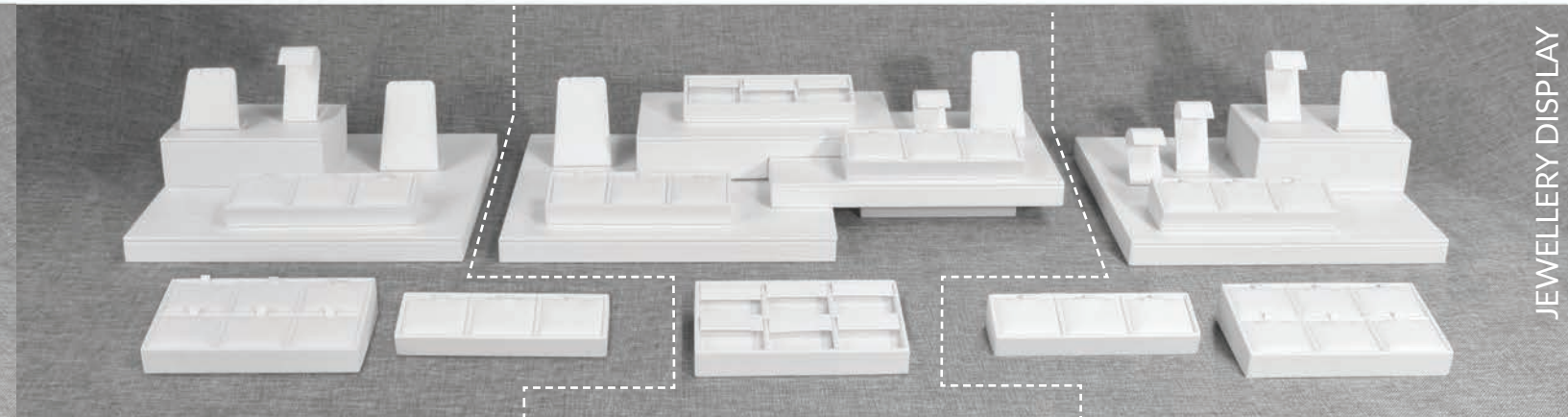

Section 1

15 sku capacity - 5 Pendants, 10 Earrings

\$136.68*

*Platforms not included

Section 2

18 sku capacity - 5 Pendants, 13 Earrings

\$121.45*

*Platforms not included

Section 3

16 sku capacity - 13 Pendants, 3 Earrings

\$121.95*

*Platforms not included

Complete 5 foot - 49 pendant/earring element display - \$380.08 **Buy \$500+ \$285.06**

Add all platforms as shown - \$363.15 **Buy \$500+ \$272.36**

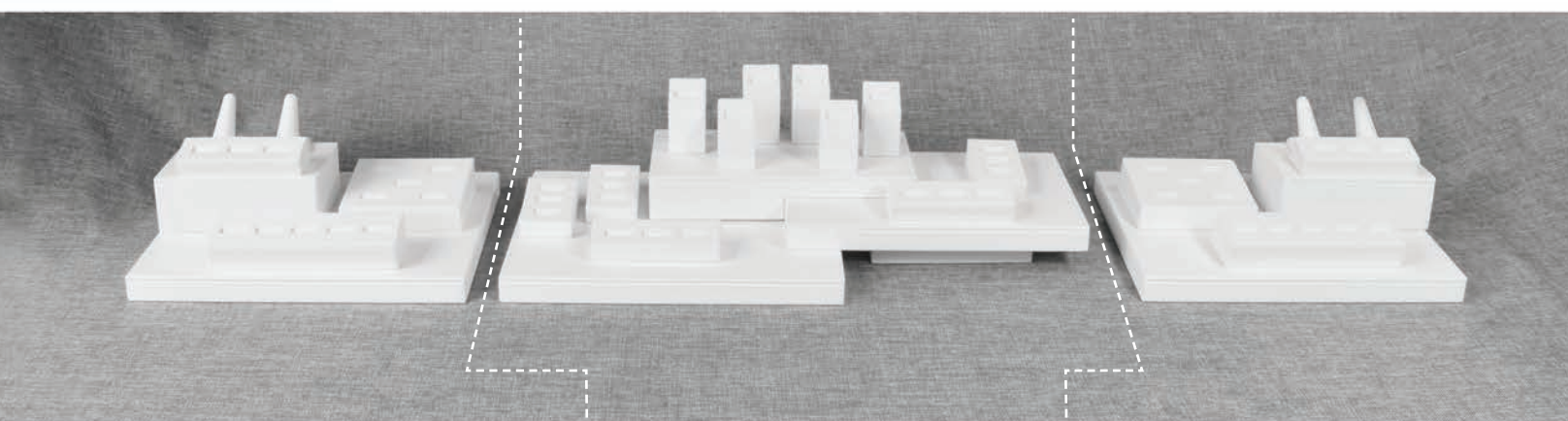

Section 1

5 sku capacity - 15 Rings

\$92.69*

*Platforms not included

Section 2

11 sku capacity - 21 Rings

\$150.12*

*Platforms not included

Section 3

5 sku capacity - 15 Rings

\$92.68*

*Platforms not included

Complete 5 foot - 51 ring element display - \$335.49 **Buy \$500+ \$251.62**

Add all platforms as shown - \$369.45 **Buy \$500+ \$277.09**

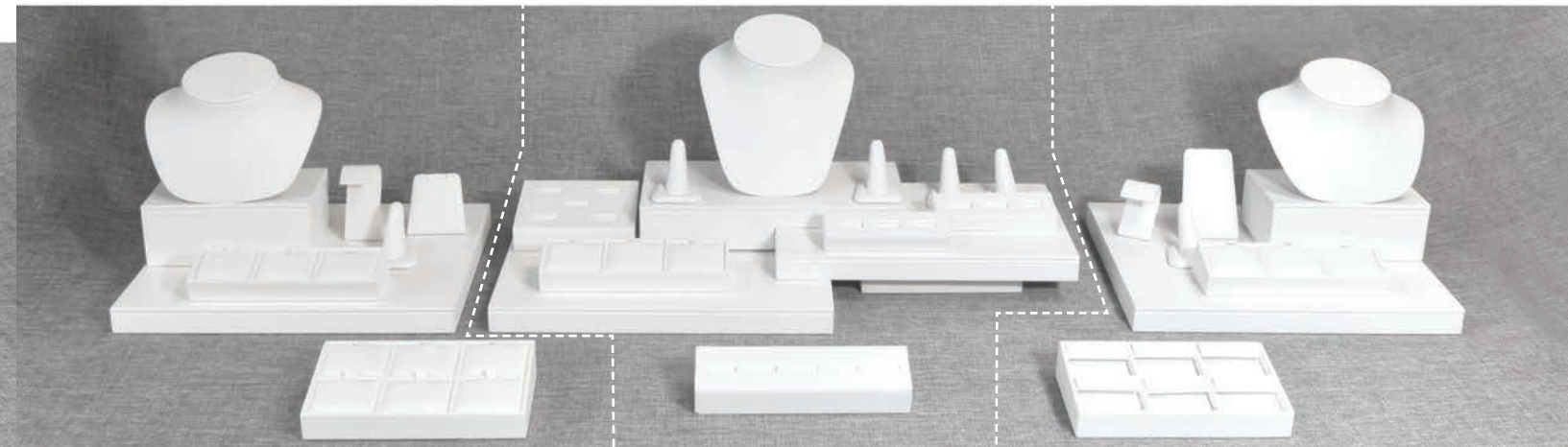

Section 1

13 sku capacity - 1 Ring, 8 Pendants, 4 Earrings

\$138.55*

*Platforms not included

Section 2

24 sku capacity - 20 Rings, 4 Pendants

\$209.66*

*Platforms not included

Section 3

13 sku capacity - 1 Ring, 2 Pendants, 10 Earrings

\$143.64*

*Platforms not included

Complete 5 foot - 50 mix element display - \$458.79 **Buy \$500+ \$344.08**

Add all platforms as shown - \$360.29 **Buy \$500+ \$270.22**





IN STOCK

All our in stock displays are covered in Vienna Chalk fabric.

Platforms and Risers

Available for immediate shipment.

Save 25% when you buy \$500 or more!

Item	Part No. / Description	Price/ea.	Item	Part No. / Description	Price/ea.
	DA80P01-SC Platform 12 x 10 x .875"	\$61.00		DA80P03-SC Platform 10 x 5 x 1.75"	\$52.94
	BUY \$500+	\$45.75		BUY \$500+	\$39.71
	DA80P02-SC Platform 11 x 7.5 x 1.875"	\$60.69		DA80332-SC Riser 3 x 3 x 2"	\$15.24
	BUY \$500+	\$45.52		BUY \$500+	\$11.43
	DA80662-SC Riser 6 x 6 x 2"	\$36.41			
	BUY \$500+	\$27.31			

* Display case floorboards are not included in the price. Material for covering your own floorboards is available and is priced by the yard. See page 65.

Platform layout suggestions



4 foot case - 26" wide, 10" deep



5 foot case - 44" wide, 10" deep



6 foot case - 52" wide, 10" deep • 19" left, 12" center and 19" right

Total price does not include applicable taxes. In stock displays and platforms are only available in VANTAGE style in Vienna fabric option.









IN STOCK

Neck Forms

All our in stock displays are covered in Vienna Chalk fabric.



Save 25% when you buy \$500 or more!

Item	Part No. / Description	Price/ea.	Item	Part No. / Description	Price/ea.
	DANF1021-SC Neck form 7.125 x 2.25 x 8.625"	\$46.73		DANF1010-SC Neck form 7.75 x 8.5 x 11"	\$81.82
	BUY \$500+	\$35.05		BUY \$500+	\$61.37
	DANF1026-SC Neck form 6 1/2 x 4 1/2 x 4"	\$34.93		DANF1029-SC Neck form 7 x 6 1/2 x 7 1/4"	\$59.45
	BUY \$500+	\$26.20		BUY \$500+	\$44.59
	DANF1028-SC Neck form 6 1/2 x 4 1/2 x 6"	\$47.15		DANF2003-SC Neck form 3 x 2 1/2 x 3 1/2"	\$22.86
	BUY \$500+	\$35.36		BUY \$500+	\$17.15
	DANF1027-SC Neck form 7 x 6 1/2 x 4 3/4"	\$62.45		DANF1034-SC Neck form 6 3/4 x 6 x 7 5/8"	\$63.22
	BUY \$500+	\$46.84		BUY \$500+	\$47.42

IN STOCK

All our in stock displays are covered in Vienna Chalk fabric.

Ring Stands and Trays

Available for immediate shipment.

Save 25% when you buy \$500 or more!

Item	Part No. / Description	Price/ea.	Item	Part No. / Description	Price/ea.
	DA80058UR-SC Ring stand 1 5/8 x 1 1/2 x 2 1/8"	\$12.59 BUY \$500+ \$9.44	 <i>Includes:</i> 1-DA80060UR 2-DA80059UR 2-DA80058UR	DA80070S-SC Ring stand set	\$56.07 BUY \$500+ \$42.05
	DA80059UR-SC Ring stand 1 5/8 x 1 1/2 x 2 1/2"	\$12.74 BUY \$500+ \$9.56		DA8004RV-SC 4 ring vertical bar 1 3/4 x 4 x 1"	\$21.33 BUY \$500+ \$16.00
	DA80060UR-SC Ring stand 1 5/8 x 1 1/2 x 2 3/4"	\$12.87 BUY \$500+ \$9.65		DA8005RH-SC 5 ring horizontal bar 7 1/4 x 1 5/8 x 1"	\$25.91 BUY \$500+ \$19.43
	DA28A01UR-SC Universal ring tray 2 3/8 x 2 1/4 x 1 1/2"	\$11.57 BUY \$500+ \$8.68		DA28C05UR-SC 5 universal ring tray 6 3/4 x 2 1/4 x 1 1/2"	\$22.86 BUY \$500+ \$17.15
	DA8002RV-SC 2 ring vertical bar 1 3/4 x 2 1/8 x 1"	\$15.24 BUY \$500+ \$11.43		DA28D05UR-SC 5 universal ring tray 4 5/8 x 4 x 1 1/2"	\$30.48 BUY \$500+ \$22.86
	DA8002RH-SC 2 ring horizontal bar 3 1/4 x 1 5/8 x 1"	\$15.24 BUY \$500+ \$11.43		DA28E05RD-SC 5 ring duo tray 6 3/4 x 4 x 1 1/2"	\$36.08 BUY \$500+ \$27.06
	DA8003RV-SC 3 ring vertical bar 1 3/4 x 3 x 1"	\$17.78 BUY \$500+ \$13.33		DA28E07UR-SC 7 ring tray 6 3/4 x 4 x 1 1/2"	\$35.57 BUY \$500+ \$26.68
	DA8003RH-SC 3 ring horizontal bar 4 1/2 x 1 5/8 x 1"	\$19.08 BUY \$500+ \$14.31			

All our in stock displays are covered in Vienna Chalk fabric.

IN STOCK

Ring Stands, Pendant Stands and Trays

Available for immediate shipment.

Save 25% when you buy \$500 or more!

Item	Part No. / Description	Price/ea.	Item	Part No. / Description	Price/ea.
	DA28D07UR-SC 7 universal ring tray 4 5/8 x 4 x 1 1/2"	\$32.52 BUY \$500+ \$24.39		DAF400T-SC Ring feature stand 2 5/8 x 2 1/4 x 2.625"	\$25.40 BUY \$500+ \$19.05
	DA28E08UR-SC 8 ring tray 6 3/4 x 4 x 1 1/2"	\$34.55 BUY \$500+ \$25.91		DAF400S-SC Ring feature stand 2 5/8 x 2 1/4 x 2.25"	\$24.90 BUY \$500+ \$18.68
	DA28D08UR-SC 8 universal ring tray 4 5/8 x 4 x 1 1/2"	\$32.23 BUY \$500+ \$24.17		DARF110-SC Ring finger 2 7/8 x 2 5/8 x 1 7/8"	\$10.13 BUY \$500+ \$7.60
	DA28E11UR-SC 11 ring tray 6 3/4 x 4 x 1 1/2"	\$34.55 BUY \$500+ \$25.91		DARD130-SC Ring disc min. order qty. of 12 1 1/4" Diameter	\$0.96 BUY \$500+ \$0.72
Item	Part No. / Description	Price/ea.	Item	Part No. / Description	Price/ea.
	DA350P-SC Pendant stand 2 3/8 x 1 1/2 x 3 1/2"	\$12.71 BUY \$500+ \$9.53		DA225P-SC Pendant stand 2 3/8 x 2 1/4 x 2"	\$10.16 BUY \$500+ \$7.62
	DA345P-SC Pendant stand 3 x 2 x 4"	\$23.72 BUY \$500+ \$17.79		DA234P-SC Pendant stand 2 1/2 x 2 x 3"	\$15.24 BUY \$500+ \$11.43
	DA28A01PD-SC Pendant tray 2 3/8 x 2 1/4 x 1 1/2"	\$13.22 BUY \$500+ \$9.92		DA28C03PD-SC 3 pendant tray 6 3/4 x 2 1/4 x 1 1/2"	\$30.48 BUY \$500+ \$22.86
	DA28D04PD-SC 4 pendant tray 4 5/8 x 4 x 1 1/2"	\$40.14 BUY \$500+ \$30.11		DA28D06PD-SC 6 pendant tray 4 5/8 x 4 x 1 1/2"	\$43.19 BUY \$500+ \$32.39
	DA28E06PD-SC 6 pendant tray 6 3/4 x 4 x 1 1/2"	\$43.19 BUY \$500+ \$32.39		DA28E08PD-SC 8 pendant tray 6 3/4 x 4 x 1 1/2"	\$48.26 BUY \$500+ \$36.20

IN STOCK

Earring Stands and Trays

Save 25% when you buy \$500 or more!

Available for immediate shipment.

All our in stock displays are covered in Vienna Chalk fabric.

Item	Part No. / Description	Price/ea.	Item	Part No. / Description	Price/ea.
	DACES14-SC Earring tree stand 2 x 2 x 3"	\$14.02 BUY \$500+ \$10.52		DACES13-SC Earring stand 1 1/4 x 1 7/8 x 2 3/4"	\$12.71 BUY \$500+ \$9.53
	DACES36-SC Earring stand 2 3/4 x 1 3/4 x 3 1/2"	\$14.02 BUY \$500+ \$10.52		DASLD6-SC Earring sled 2 x 8 1/4 x 2"	\$15.24 BUY \$500+ \$11.43
	DA28A01FE-SC Flap earring tray 2 3/8 x 2 1/4 x 1 1/2"	\$15.24 BUY \$500+ \$11.43		DA28A01PE-SC Pierced earring tray 2 3/8 x 2 1/4 x 1 1/2"	\$13.10 BUY \$500+ \$9.82
	DA28C03FE-SC 3 flap earring tray 6 3/4 x 2 1/4 x 1 1/2"	\$25.40 BUY \$500+ \$19.05		DA28C03PE-SC 3 pierced tray 6 3/4 x 2 1/4 x 1 1/2"	\$27.44 BUY \$500+ \$20.58
	DA28D04FE-SC 4 flap earring tray 4 5/8 x 4 x 1 1/2"	\$40.14 BUY \$500+ \$30.11		DA28D04PE-SC 4 pierced earring tray 4 5/8 x 4 x 1 1/2"	\$35.29 BUY \$500+ \$26.47
	DA28D06FE-SC 6 flap earring tray 4 5/8 x 4 x 1 1/2"	\$45.73 BUY \$500+ \$34.30		DA28D06PE-SC 6 pierced earring tray 4 5/8 x 4 x 1 1/2"	\$50.53 BUY \$500+ \$37.90
	DA28E06FE-SC 6 flap earring tray 6 3/4 x 4 x 1 1/2"	\$45.73 BUY \$500+ \$34.30		DA28E06PE-SC 6 pierced earring tray 6 3/4 x 4 x 1 1/2"	\$43.19 BUY \$500+ \$32.39
	DA28E08FE-SC 8 flap earring tray 6 3/4 x 4 x 1 1/2"	\$53.82 BUY \$500+ \$40.37		DA28E08PE-SC 8 pierced earring tray 6 3/4 x 4 x 1 1/2"	\$48.27 BUY \$500+ \$36.20

IN STOCK

All our in stock displays are covered in Vienna Chalk fabric.

Earring, Bangle and Bracelet Stands, Chain Ramps, Counter Pads and Signage

Available for immediate shipment.

Save 25% when you buy \$500 or more!

Item	Part No. / Description	Price/ea.	Item	Part No. / Description	Price/ea.
	05000755 Earring stand 7 x 4 1/2 x 1 3/4"	\$43.20 BUY \$500+ \$32.40		DABS185-SC Bracelet sled 1 1/4 x 9 1/4 x 1 3/4"	\$13.00 BUY \$500+ \$9.75
	DASBS12-SC Bangle "T" bar 7 1/8 x 2 3/4 x 5 1/4" (dia. 1.625")	\$32.50 BUY \$500+ \$24.38		DABS485-SC Bracelet sled 4 x 9 5/8 x 1 7/8"	\$21.68 BUY \$500+ \$16.26
	DAJP350V-SC Bracelet pillow w/stand 3 1/4 x 3 1/4 x 3 1/4"	\$12.68 BUY \$500+ \$9.29		DADB425-SC Bracelet dome 4 1/8 x 5 1/8 x 2 1/2"	\$34.28 BUY \$500+ \$25.71
	DACHR16-SC Chain ramp / Rem. pad 10 1/4 x 16" chain pad 10 3/4 x 16 1/2 x 3 1/2"	\$122.34 BUY \$500+ \$91.76		DA1081R-SC Pres. tray w/ring 10 1/2 x 8 5/8 x 1"	\$64.92 BUY \$500+ \$48.69
	New 05000845-SC 16 Chain Tray Stackable 8 5/8 x 13 3/4 x 1 1/2"	\$155.36 BUY \$500+ \$116.52		DAPCF5510-SC Counter pad plain 5 1/4 x 10 1/4 x 3/4" closed 10 3/4 x 10 1/4 x 3/8" open	\$42.48 BUY \$500+ \$31.86
	DACW884-SC Chain display wedge 8 x 8 x 3 3/4"	\$65.54 BUY \$500+ \$49.16		DASB211 Sign stand 2 3/4 x 2 3/16 x 1 1/4"	\$16.75 BUY \$500+ \$12.56

IN STOCK

All our in stock displays are covered in Vienna Chalk fabric.

Specialty Items

Available for immediate shipment.

Save 25% when you buy \$500 or more!

Item	Part No. / Description	Price/ea.	Item	Part No. / Description	Price/ea.
	05000300-SC Loose Diamond Arch 11.5" x 4" x 1.5"	\$75.95 BUY \$500+ \$56.92		05000301 Diamond Cup 1.125" diameter x .75"	\$14.11 BUY \$500+ \$10.58
	05000299-SC Pearl Half Moon 8" x 8" x 3.25"	\$97.62 BUY \$500+ \$73.22		05000298-SC Wave Chain Ramp 10.125" x 9" x 2.625"	\$112.91 BUY \$500+ \$84.68
	Sign size: 3.9375" x 2.375" 05000300 Acrylic Sign 1.1875" x 4" x 2.75"	\$16.44 BUY \$500+ \$12.33		05000302 Bevelled Edge Mirror 8.5" x 8.25" x 5.5"	\$56.07 BUY \$500+ \$42.05
	05000581-SC Pendant/earring tray with PVC signage 4.75" x 9.5" x 2"	\$54.80 BUY \$500+ \$41.10		36301103 Small Vision Box 2.68 x 2.68 x .75"	\$1.19
				36302103 Medium Vision Box 3.5 x 3.5 x .75"	\$1.59
				36303103 Large Vision Box 4.25 x 4.25 x .75"	\$1.99
				69300103 Base for Vision Box 2.24 x 2.24 x .62" Bag of 12	\$0.99

JEWELLERY STORAGE by MELE & Co



IN STOCK

Visit Melejewelrybox.com for order information.

Jewellery Storage by MELE AND Co



THE STOWAWAY LINE

- Vegan leather with coordinating zipper pull
- Cream anti-tarnish microsuede interior lining and metal zipper closure
- Custom leather option upon request
- Branded cleaning cloth and reusable dust bag included



The Essentials Colour Line

Code	Description	Size (inches)	Pack
A 00629__	Bento	7 x 6.25 x 3.125	2
B 00518__	Duo	6.875 x 3 x 5.25	2
C 00513__	Duo Mini	5 x 3.75 x 2	4
D 00626__	Stow and Go	5 x 5 x 2.25	2
E 00618__	Stow and Go Mini	3.5 (D) x 1.625	4

	Black - 62	Buff - 44	Ecru - 10
Bento	✓	✓	—
Duo	✓	✓	—
Duo Mini	✓	✓	✓
Stow and Go	✓	✓	✓
Stow and Go Mini	✓	✓	✓

Visit melejewelrybox.com for these plus other fashion forward, timeless classics and youthful collections!



Everly Kate Kelby Geneva Olympia Grant

BAGS

EUROTOTES, PAPER, POLY & REUSABLE



IN STOCK

Rope Handle Eurototes

BAGS



08V - Silver

Linen Paper Detail

Vantage II Eurototes Available Colours



08V - Silver
Matches Vantage Silver
Hinged Packaging
See page 29.

07V - Gold
Matches Vantage Gold
Hinged Packaging
See page 29.

Vantage II Eurototes

- 150 gsm uncoated art paper
- 5 mm pp cord knotted handles
- Folded top turn and cardboard reinforced bottom
- Minimum order is 100 per colour per size

CODE	SIZE (inches)	PRICE/EACH		
		100+	500+	1000+
A 230606 ___	6 x 3.5 x 6 x 3.5	\$1.22	\$1.12	\$0.96
B 231008 ___	10.5 x 5 x 8.5 x 5	\$1.55	\$1.39	\$1.19

Estimated lead time: 2 - 3 weeks for printed items from approved art.



FOIL PRINT
100+ 35¢ each
1000+ 32¢ each
2500+ 26¢ each

Eclipse and Geo Eurototes Available Colours



56G - Purple
Matches Geo Purple
Hinged Packaging
See page 23.

27G - Bronze
Matches Geo Bronze
Hinged Packaging
See page 23.



27G - Bronze

Shimmer Paper Detail

Eclipse and Geo Eurototes

- 150 gsm uncoated art paper
- 5 mm pp cord knotted handles
- Folded top turn and cardboard reinforced bottom
- Minimum order is 100 per colour per size

66E - Aubergine
Matches Eclipse Aubergine
Hinged Packaging
See page 19.

81E - Blue
Matches Eclipse Blue
Hinged Packaging
See page 19.

IN STOCK

Rope Handle Eurototes

BAGS



Laminated Eurotote with Rope Handle

- Matte lamination
- 157 gsm art paper
- 5 mm pp cord knotted polypropelene handle
- Folded top turn and cardboard reinforced bottom
- Minimum order is 100 per colour per size

CODE	TYPE	SIZE (inches)	PRICE/EACH		
			100+	500+	1000+
A 239606 __	Novelty	6 x 3.5 x 6 x 3.5	\$1.11	\$0.99	\$0.87
B 239709 __	Small gift	9 x 3.5 x 7 x 3.5	\$1.27	\$1.08	\$0.97
C 239810 __	Gift	8 x 4 x 10 x 4	\$1.39	\$1.19	\$1.08
D 230908 __ T	Trapezoid	9/7 x 4 x 8.5 x 4	\$1.64	\$1.33	\$1.28
E 238116 __	Fashion	16 x 6 x 12 x 6	\$2.57	\$2.26	\$1.96
F 231011 __	Watch	10 x 5 x 11 x 5	\$1.79	\$1.47	\$1.32

Estimated lead time: 2 - 3 weeks for printed items from approved art.



DIGITAL PRINT
100+ \$2.45 each
1000+ \$2.25 each
300 bags minimum



FOIL PRINT
100+ 35¢ each
1000+ 32¢ each
2500+ 26¢ each



	15-Black	00-White	07-Gold	08-Silver	42-Brown	11-Blue	10-Green
Novelty	✓	✓	✓	✓	✓	✓	✓
Small Gift	✓	✓	✓	✓	✓	✓	✓
Gift	✓	✓	✓	✓	✓	✓	✓
Trapezoid	✓	✓	✓	—	✓	—	—
Fashion	✓	✓	✓	✓	✓	—	—
Watch	✓	✓	✓	—	—	—	—

All print orders subject to set-up charges. Applicable artwork, and plate charges may apply. See page 122.

All print orders subject to set-up charges. Applicable artwork, and plate charges may apply. See page 122.

IN STOCK

Luxury Grosgrain Handle Eurototes

IN STOCK

All Paper Eurototes

BAGS

BAGS



Luxury Grosgrain Handle Eurototes

- Gloss and matte lamination
- 157 gsm art paper
- 7/8" matching grosgrain, knotted handles
- Fold over top turn and cardboard reinforced bottom
- Minimum order is 100 per colour per size

CODE	SIZE (inches)	CASE PACK	PRICE/EACH		
			100+	500+	1000+
A 230606	6 x 3 x 6 x 3	100	\$1.12	\$1.01	\$0.87
B 230810	8 x 4 x 10 x 4	100	\$1.18	\$1.06	\$0.91
C 231209	12.5 x 4.5 x 9 x 4.5	100	\$1.42	\$1.28	\$1.10
D 231612	16 x 6 x 12 x 6	100	\$1.93	\$1.74	\$1.49
E 232014	20 x 6 x 14 x 6	100	\$2.16	\$1.94	\$1.67

* champagne and pewter not available in this size.

Available Colours



15BM Black Matte 15BG Black Gloss 02C Champagne 08P Pewter 00W White

Estimated lead time: 2 - 3 weeks for printed items from approved art.

DIGITAL PRINT
100+ \$2.45 each
1000+ \$2.25 each
300 bags minimum

FOIL PRINT
100+ 35¢ each
1000+ 32¢ each
2500+ 26¢ each

All Paper Eurotote with Paper Rope Handle

- 100% recyclable
- 40% post-consumer waste
- 190 gsm uncoated paper
- 8 mm paper cord knotted handles
- Folded top turn and cardboard reinforced bottom
- Minimum order is 100 per colour per size

CODE	SIZE (inches)	CASE PACK	PRICE/EACH		
			100+	500+	1000+
A 230606	6 x 3.5 x 6 x 3.5	100	\$0.94	\$0.83	\$0.71
B 230810	8 x 4 x 10 x 4	100	\$1.03	\$0.91	\$0.77
C 231013	10 x 5 x 13 x 5	100	\$1.17	\$1.03	\$0.87
D 231612	16 x 6 x 12 x 6	100	\$1.77	\$1.56	\$1.33



Available Colours



75AK Kraft 00AW White 15AB Black 28AC Cream

Estimated lead time: 2 - 3 weeks for printed items from approved art.

FOIL PRINT
100+ 35¢ each
1000+ 32¢ each
2500+ 26¢ each

All print orders subject to set-up charges. Applicable artwork, and plate charges may apply. See page 122.

All print orders subject to set-up charges. Applicable artwork, and plate charges may apply. See page 122.

CREATE YOUR OWN LOOK

Full Colour Paper Eurototes

Make a creative impression...
the combinations are endless!



Prices include up to 2 ink print colours:

TYPE	SIZE (inches)
Novelty	6 x 3.5 x 6 x 3.5
Small Gift	9 x 3.5 x 7 x 3.5
Gift	8 x 4 x 10 x 4
Trapezoid	9/7 x 4 x 8.5 x 4
Wine	3.375 x 3.5 x 13 x 3.5
Fashion	16 x 6 x 12 x 6
Saville	16 x 6 x 19 x 6

Prices include 4 colour process print:

TYPE	SIZE (inches)
Novelty	6 x 3.5 x 6 x 3.5
Small Gift	9 x 3.5 x 7 x 3.5
Gift	8 x 4 x 10 x 4
Trapezoid	9/7 x 4 x 8.5 x 4
Wine	3.375 x 3.5 x 13 x 3.5
Fashion	16 x 6 x 12 x 6
Saville	16 x 6 x 19 x 6

- Combination foil print and ink printing available.
- No charge for printing plates (proof charge applies)
- Substitute a satin ribbon handle for the standard rope
- Add metal grommets to your bag



Unique printing options available.
Double Stamping shown here.

Estimated lead time: 14 - 16 weeks for delivery from approved art.



Create Your Own Look:

Choose your bag style.
Send us your artwork.
For 100% full colour design, speak to your sales representative.

SPECIAL ORDER 5th Avenue Eurototes



Thick Woven Handle Detail



5th Avenue Eurototes

- Embossed laminated finish with printed gloss coordinating colour interior
- 210 gsm
- Thick woven handles, top slit style
- W fold & removable bottom board
- Minimum order is 100 per colour per size

CODE	SIZE (inches)	CASE PACK	PRICE/EACH	
			100+	1000+
A 245820 __	8 x 3.5 x 6 x 3.5	100	\$3.21	\$3.04
B 245821 __	12.5 x 4.5 x 9 x 4.5	100	\$5.08	\$4.82
C 245822 ___	17 x 6 x 12.75 x 6	100	\$6.94	\$6.57

Estimated lead time: 3 - 5 weeks for printed items from approved art.

DIGITAL PRINT
100+ \$2.45 each
1000+ \$2.25 each
300 bags minimum

FOIL PRINT
100+ 35¢ each
1000+ 32¢ each
2500+ 26¢ each

Available Colours



15 Black/Gloss Black 08 Silver/Gloss Silver 00 White/Gloss Silver

All print orders subject to set-up charges. Applicable artwork, and plate charges may apply. See page 122.

SPECIAL ORDER

SPECIAL ORDER

Paper Shoppers

New



Totally Trim Paper Shoppers

- Twist paper handle with bottom gusset
- 100% recyclable and biodegradable
- Minimum order per colour per size



CODE	DESCRIPTION	SIZE (inches)	CASE PACK	PRICE/EACH	
				300+	1000+
245111 __	Small (90 gsm)	11.8 x 9.8 x 3.9	300	\$0.68	\$0.62
245114 __	Medium (100 gsm)	14.2 x 10.6 x 3.9	250	\$0.78	\$0.70
245118 __	Large (100 gsm)	18.1 x 12.4 x 5.9	300	\$0.95	\$0.86
245119 __	Extra Large (100 gsm)	19.7 x 16.3 x 5.9	250	\$1.10	\$0.99



DIGITAL PRINT
100+ \$2.45 each
1000+ \$2.25 each
300 bags minimum



INK PRINT
100+ 34¢ each
1000+ 29¢ each
2500+ 24¢ each



FOIL PRINT
100+ 35¢ each
1000+ 32¢ each
2500+ 26¢ each

Estimated lead time: 2 - 3 weeks for printed items from approved art.



Tints and Pinstripe on Kraft

- Twist paper handle
- 120 gsm paper



Pinstripe Detail

Tints on Kraft



Pinstripe on Kraft



CODE	DESCRIPTION	SIZE (inches)	CASE PACK	PRICE/EACH
230508 ____	Prime	5 x 3 x 8 x 3	250	\$0.92
230809 ____	Petite	8 x 4.5 x 10	250	\$0.95
231611 ____	Fashion	16 x 6 x 12 x 6	250	\$1.50



DIGITAL PRINT
250+ \$2.45 each
1000+ \$2.25 each
300 bags minimum



INK PRINT
250+ 34¢ each
1000+ 29¢ each
2500+ 24¢ each

Estimated lead time:
Aprox. 6 weeks for No Print Bags.
Aprox 8 - 10 weeks for Printed items from approved art.

All print orders subject to set-up charges. Applicable artwork, and plate charges may apply. See page 122.

BAGS

BAGS



12" Wide Gussets!



Manhattan Eurototes

- Uncoated paper with varnish finish*
- 180 gsm wood-free paper
- 5/8" poly/cotton twill knotted handle
- Folded top turn and cardboard reinforced bottom
- 200 gsm kraft paper 75% recycled** (colour chart reference)

CODE	TYPE	CASE	PRICE/EACH		
			100+	500+	1000+
A 245845 __	Mini	100	\$1.25	\$1.18	\$1.12
B 245841 __	Petite	100	\$1.56	\$1.48	\$1.40
C 245843 __	Vanity	100	\$1.98	\$1.87	\$1.78
D 245844 __	Fashion	100	\$2.71	\$2.57	\$2.44
E 245860 __	X-Large	50	\$4.18	\$3.96	\$3.76
F 245898 __	Bottle Bag	100	\$1.71	\$1.62	\$1.54

WIDE GUSSET EUROTOTES			PRICE/EACH		
CODE	TYPE	CASE	100+	500+	1000+
24585615	Medium - Black	100	\$5.57	\$5.28	\$5.02
24585715	Large - Black	100	\$6.24	\$5.91	\$5.61
24585600	Medium - White	100	\$5.57	\$5.28	\$5.02
24585700	Large - White	100	\$6.24	\$5.91	\$5.61
24585675	Medium - Kraft	100	\$5.57	\$5.28	\$5.02
24585775	Large - Kraft	100	\$6.24	\$5.91	\$5.61



Size	15* Black	00* White	75** Kraft	08* Grey	09* Red	41* Fuchsia	11** Navy
Mini 5 x 4 x 6 x 4 in	✓	✓	✓	✓	✓	✓	✓
Petite 8 x 4 x 10 x 4 in	✓	✓	✓	✓	✓	✓	✓
Vanity 10 x 5 x 13 x 5 in	✓	✓	✓	✓	✓	✓	✓
Fashion 16 x 6 x 12 x 6 in	✓	✓	✓	✓	✓	✓	✓
X-Large 20 x 6 x 14 x 6 in	✓	✓	✓	—	—	—	—
Bottle 4.5 x 4.5 x 15 x 4.5 in	✓	✓	✓	—	✓	—	—
Wide Gusset Medium 12.5 x 12 x 12 x 12 in.	✓	✓	✓	—	—	—	—
Wide Gusset Large 16 x 12 x 11 x 12 in.	✓	✓	✓	—	—	—	—

Estimated lead time: 3 - 5 weeks for printed items from approved art.



DIGITAL PRINT
100+ \$2.45 each
1000+ \$2.25 each
300 bags minimum



FOIL PRINT
100+ 35¢ each
1000+ 32¢ each
2500+ 26¢ each

All print orders subject to set-up charges. Applicable artwork, and plate charges may apply. See page 122.

CREATE YOUR OWN LOOK

Full Colour Simply Paper Shoppers

Make a creative impression...
the combinations are endless!



Simply Paper Shoppers

Kraft with paper twist handles, print 1 colour on 2 sides <25%

TYPE	SIZE (inches)	CASE PACK
Prime	5.25 x 3.5 x 8.25	250
Petite	8 x 4 x 10	250
Vanity	10 x 5 x 13	250
Celebrity	13 x 6 x 15.5	250
Fashion	16 x 6 x 12	250
Saville	16 x 6 x 19	200
Universal	18 x 6 x 19	200
Wine	5.25 x 3.5 x 13	250

Any 2 Sizes
Minimum 3000
Special Pricing

White with paper twist handles, print 1 colour on 2 sides <25%

TYPE	SIZE (inches)	CASE PACK
Prime	5.25 x 3.5 x 8.25	250
Petite	8 x 4 x 10	250
Vanity	10 x 5 x 13	250
Celebrity	13 x 6 x 15.5	250
Fashion	16 x 6 x 12	250
Saville	16 x 6 x 19	200
Universal	18 x 6 x 19	200
Wine	5.25 x 3.5 x 13	250

Any 2 Sizes
Minimum 3000
Special Pricing



Create Your Own Look:
Choose your bag style.
Send us your artwork.
For 100% full colour
design, speak to your
sales representative.



96% Recycled Material

• Minimum 5,000 per size or any
2 sizes, minimum 3000 per size

• Add a second colour

• Go 100% ink coverage

• Add a rope handle

Estimated lead time: 12 - 14
weeks for printed items from
approved art.



Paper Twist Handle Shopping Bags

- 100% recyclable
- Kraft: 90% post-consumer waste/ White: 100% virgin paper
- 110 gsm paper (80 gsm for kraft and black)
- Minimum order is 250/200 per colour per size

CODE	TYPE	SIZE (inches)	CASE	12 - Kraft PRICE/EACH		00 - White PRICE/EACH		Tints PRICE/EACH		Metallics PRICE/EACH	
				250+	1000+	250+	1000+	250+	1000+	250+	1000+
230508_*	Prime	5 x 3.5 x 8 x 3.5	250	\$0.42	\$0.36	\$0.52	\$0.41	\$0.65	\$0.55	\$0.68	\$0.58
230809_	Petite	8 x 4.5 x 10.75 x 4.5	250	\$0.47	\$0.42	\$0.52	\$0.45	\$0.68	\$0.61	\$0.72	\$0.65
230914_	Vanity	10 x 5 x 13 x 5	250	\$0.52	\$0.50	\$0.57	\$0.52	—	—	—	—
231315_	Celebrity	13 x 6 x 15 x 6	250	\$0.59	\$0.55	\$0.68	\$0.63	—	—	—	—
231611_	Fashion	16 x 6 x 12 x 6	250	\$0.58	\$0.55	\$0.63	\$0.57	\$0.83	\$0.73	\$1.14	\$1.04
231619_	Saville	16 x 6 x 19 x 6	**	\$0.75	\$0.64	\$0.86	\$0.75	\$1.12	\$1.03	\$1.78	\$1.65
231819_	Universal	18 x 7 x 18.75 x 7	200	\$0.77	\$0.68	\$0.83	\$0.75	—	—	—	—
230513_	Wine Shopper	5.25 x 3.5 x 13	250	\$0.78	\$0.73	\$0.93	\$0.87	—	—	—	—

Available Colours

	12- Kraft	00- White	35- Black	41- Navy	07- Gold	08- Silver
Prime	✓	✓	✓	✓	✓	✓
Petite	✓	✓	✓	✓	✓	✓
Vanity	✓	✓	—	—	—	—
Celebrity	✓	✓	—	—	—	—
Fashion	✓	✓	✓	✓	✓	✓
Saville	✓	✓	✓	✓	✓	✓
Universal	✓	✓	✓	✓	✓	✓
Wine	✓	✓	—	—	—	—

* White and Kraft is 230508_ _P

* Black, Navy, Gold and Silver 230508_ _PR

** White and Kraft are sold in case packs of 200 and the Black, Navy, Gold and Silver are sold in case packs of 250

**Sturdy, durable.
Our best value bags.**



DIGITAL PRINT
100+ \$2.45 each
1000+ \$2.25 each
300 bags minimum



FOIL PRINT
100+ 35¢ each
1000+ 32¢ each
2500+ 26¢ each



INK PRINT
100+ 34¢ each
1000+ 29¢ each
2500+ 24¢ each

Please allow 2 - 3 weeks
for printed items from
approved art.



Damask Paper Shoppers

- 110 gsm paper
- Minimum order is 100 per size

CODE	TYPE	SIZE (inches)	CASE PACK	PRICE/EACH	
				100+	1000+
23080915D	Petite	8 x 4 x 10 x 4	100	\$0.67	\$0.59
23101315D	Vanity	10 x 5 x 13 x 5	100	\$0.72	\$0.62
23161215D	Fashion	16 x 6 x 12 x 6	100	\$0.84	\$0.72



DIGITAL PRINT
100+ \$2.45 each
1000+ \$2.25 each
300 bags minimum



FOIL PRINT
100+ 35¢ each
1000+ 32¢ each
2500+ 26¢ each



INK PRINT
100+ 34¢ each
1000+ 29¢ each
2500+ 24¢ each

Please allow 2 - 3 weeks for printed
items from approved art.

All print orders subject to set-up charges. Applicable artwork, and plate charges may apply. See page 122.

IN STOCK

Paper Shoppers

The Mission Green Sustainable Solution for single-use plastic merchandise shoppers.



Kraft Paper Bag with Die Cut Handles

- 70% post-consumer recycled material
- 90 gsm kraft paper
- 125 gsm kraft paper
- Durable reinforced handles
- Minimum order is 250 per colour per size

CODE	SIZE (inches)	CASE PACK	PRICE/EACH	
			250+	1000+
White:				
23101300WF	10 x 3.14 x 13 x 3.14	250	\$0.31	\$0.28
23141800WF	14 x 3.14 x 18 x 3.14	250	\$0.41	\$0.37
Kraft:				
23141812KF	14 x 3.14 x 18 x 3.14	250	\$0.35	\$0.31

Merchandise Die Cut Bags

- Reinforced fold-over handle plus side gusset
- 80 gsm paper

CODE	SIZE (inches)	CASE PACK	PRICE/EACH
23081275	8 x 2 x 12	500	\$0.38
23101575	10 x 2 x 15	500	\$0.42
23141875	14 x 4 x 18	250	\$0.60



Merchandise Bags

- 110 gsm paper

CODE	SIZE (in)	CASE	75 - Kraft	00 - White
			PRICE/EACH	PRICE/EACH
230609__	6 x 9	2000	\$0.07	\$0.09
230710__	7 x 10	500	\$0.08	\$0.08
230912__	9 x 12	500	\$0.09	\$0.13
231114__	11 x 14	500	\$0.12	\$0.18
231316__	13 x 16	500	\$0.18	\$0.23



DIGITAL PRINT
100+ \$2.45 each
1000+ \$2.25 each
300 bags minimum

FOIL PRINT
100+ 35¢ each
1000+ 32¢ each
2500+ 26¢ each

INK PRINT
100+ 34¢ each
1000+ 29¢ each
2500+ 24¢ each

Please allow 2 - 3 weeks for printed items from approved art.

IN STOCK

Food Service Paper



Tamper Proof Strips Across Both Sets of Handles



Food Service Kraft Paper Shoppers

- Sturdy and durable
- 110 gsm
- Made from 100% recycled kraft paper

CODE	DESCRIPTION	SIZE (inches)	CASE PACK	PRICE/EACH	
				250+	1000+
A 23121775F	SOS Shopper	12 x 7 x 17 x 7	250	\$0.26	\$0.24
B 23141512F	Paper Twist with Tamper Tape	14 x 10 x 15.5 x 10	200	\$0.82	\$0.71

DIGITAL PRINT
100+ \$2.45 each
1000+ \$2.25 each
300 bags minimum

INK PRINT
100+ 34¢ each
1000+ 29¢ each
2500+ 24¢ each

FOIL PRINT
100+ 35¢ each
1000+ 32¢ each
2500+ 26¢ each

Please allow 2 - 3 weeks for printed items from approved art.

All print orders subject to set-up charges. Applicable artwork, and plate charges may apply. See page 122.

All print orders subject to set-up charges. Applicable artwork, and plate charges may apply. See page 122.

CREATE YOUR OWN LOOK

Full Colour Simply Poly Shopping Bags

Make a creative impression...
the combinations are endless!



Poly Shopping Bags

Customize simply and affordably.

CODE	TYPE	STANDARD PRINT SIZE
550907	Small Gift	5" wide
550414	Wine	2.5" wide
550810	Petite	5" wide
551612	Fashion	9" wide
551816	Majestic	10" wide

- Print two sides in 1 ink colour (maximum 25% ink coverage)
- Constructed of 3.0 mil high density poly
- Coordinating poly loop handles included in price
- Poly Shoppers minimum quantity 3,000 per size

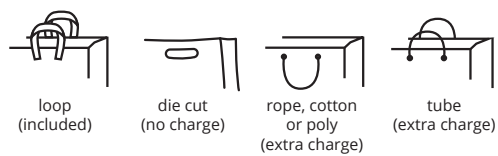

No Plate Charges*

*Does not include process plates.

Poly Merchandise Bags

CODE	SIZE (in)	STANDARD PRINT SIZE
550912	9 x 12	6" wide
551114	11 x 14	7" wide
551216	12 x 16 + 3	8" wide
551416	14 x 16 + 3	10" wide
551720	17 x 20 + 4	12" wide
551816	18 x 16 + 4	13" wide
552020	20 x 20 + 4	14" wide
552024	20 x 24 + 4	14" wide

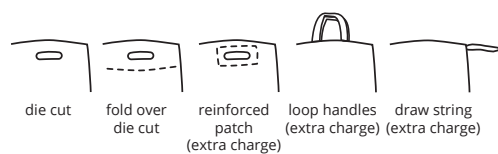

- Constructed of 1.5 mil gauge poly.
- Minimum quantity 5,000 (small sizes)/ 3,000 (large sizes).
- Print two sides in 1 ink colour (maximum 25% ink coverage).



Create Your Own Look:
Choose your bag style.
Send us your artwork.
For 100% full colour design, speak to your sales representative.

Estimated lead time: 14 - 16 weeks for printed items from approved art.

IN STOCK Poly Shoppers



Frosted Translucent Bags

Estimated lead time: 2 - 3 weeks for printed items from approved art.

- 2.0 mil clear HDPE merchandise, and 3.0 mil clear HDPE shoppers
- Minimum order one case pack
- Please allow 2 - 3 weeks for printed items from approved art

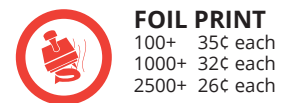

FOIL PRINT
100+ 35¢ each
1000+ 32¢ each
2500+ 26¢ each

CODE	TYPE	GAUGE	SIZE (in)	CASE PACK	PRICE/EACH
A 55091200E	Merchandise	2.0	9 x 12	1000	\$0.10
B 55141800E	Merchandise	2.0	14 x 18 + 3	1000	\$0.24
C 55081000E	Petite Shopper	3.0	8 x 4 x 10 x 4	250	\$0.44
D 55161200E	Fashion Shopper	3.0	16 x 6 x 12 x 6	250	\$0.63
E 55181600E	Majestic Shopper	3.0	18 x 6 x 16 x 6	250	\$0.69



Foil Printed Merchandise Bags

- Constructed of 1.75 mil low density poly
- Foil Printing is available on one side only and is included in the price of the printed bags
- Minimum one case pack, printed and unprinted
- Die charge extra
- For no-print option please add N to code number

Estimated lead time: 2 - 3 weeks for printed items from approved art.

CODE	HANDLE TYPE	SIZE (inches)	CASE PACK	PRICE/EACH		
				1000 Foil Print	3000 Foil Print	1000 NO PRINT
A 220609 __ *	Notion	6 x 9	1000	\$0.24	\$0.16	\$0.11
B 220811 __ *	Die Cut	8.25 x 11	1000	\$0.30	\$0.23	\$0.17
C 221114 __ *	Die Cut	11 x 14	1000	\$0.32	\$0.26	\$0.18
D 221418 __	Die Cut	14.5 x 18	1000	\$0.40	\$0.35	\$0.21
E 221721 __	Patch	16.5 x 20 + 4	500	\$0.50	\$0.43	\$0.25

* Gold available in 3 sizes only

All print orders subject to set-up charges. Applicable artwork, and plate charges may apply. See page 122.

CREATE YOUR OWN LOOK

Reusable Fabric Style Shoppers

Make a creative impression...
the combinations are endless!



Full Colour Laminated Bags

- Plates extra per design/side.
Additions for extra charge
- Add matte lamination /bag
 - Add a carded bottom /bag
 - Zipper top /bag
 - Gusset print /bag

Shopping Bags (inches)

- 9 x 4 x 11 x 4
- 11 1/4 x 4 1/4 x 12 x 4 1/4
- 14 x 4 x 16 x 4
- 16 x 6 x 12 x 6
- 16 x 5 x 15 x 5

80 GSM NON-WOVEN
SILK SCREEN PRINT ONE COLOUR 2 SIDES
1"X24" HANDLES - "X" STITCH

100 GSM NON-WOVEN WITH LAMINATION
PRINT 4 COLOUR PROCESS
1"X24" PP WEBBING HANDLES - "X" STITCH

120 GSM PP WOVEN WITH LAMINATION
PRINT 4 COLOUR PROCESS
1"X24" PP WEBBING HANDLES - "X" STITCH



Non-woven Polypropylene

Soft, yet durable. Use this for light to medium weight loads.



Woven Polypropylene

Our strongest material. This rigid weave will handle heavy items.

Many more sizes available
- just ask!



Create Your Own Look:
Choose your bag style.
Send us your artwork.
For 100% full colour design, speak to your sales representative.

- Minimum quantity 2,000 per size

Estimated lead time: 14 - 16 weeks for printed items from approved art.

IN STOCK

Reusable RPET Laminated Tote



Mission Green Sustainable solution made with 80% recycled RPET + Lamination

- 100 gsm with matte lamination
- Corner sewn style with RPET handle
- Small bag made with 7 recycled plastic bottles
- Large bag made with 11 recycled plastic bottles
- Eco-friendly, durable, recycled

RPET is known as Recycled Polyethylene Terephthalate. It's a strong, durable material constructed from 80% recycled plastic bottles.



80% Recycled PET

CODE	SIZE (inches)	CASE PACK	PRICE/EACH	
			100+	1000+
21081035R	8 x 4 x 10 x 4	100	\$1.68	\$1.32
21141635R	14 x 6 x 16 x 6	100	\$2.43	\$1.82



DIGITAL PRINT
100+ \$2.45 each
1000+ \$2.25 each
300 bags minimum



FOIL PRINT
100+ 35¢ each
1000+ 32¢ each
2500+ 26¢ each

Please allow 2 - 3 weeks for printed items from approved art.

All print orders subject to set-up charges. Applicable artwork, and plate charges may apply. See page 122.

SPECIAL ORDER

Reusable Fabric Shoppers

IN STOCK

Reusable Shoppers

BAGS

BAGS



New

Upcycle Laminated Totes

- RPET plus matte lamination
- W-fold bottom
- Eco-friendly, durable, recycled
- Small bag made of 2 water bottles - 140 gsm
- Medium bag made of 5 water bottles - 155 gsm
- Large bag made of 7 water bottles - 155 gsm

CODE	DESCRIPTION	SIZE (inches)	CASE PACK	PRICE/EACH	
				150+	1000+
245905 __	Small*	8 x 10 x 5.25	225	\$1.31	\$1.24
245906 __	Medium**	12 x 14 x 7	150	\$1.97	\$1.87
245907 __	Large**	18 x 14 x 7.5	75	\$2.48	\$2.35

* 08 - Grey (available while quantities last)
 ** 08 - Grey (out of stock)



Top Turn Graphics Illustrate Recycled Bottle Content

Available Colours



15 - Black 08 - Grey 00 - White

Please allow 3 - 5 weeks for printed items from approved art.



FOIL PRINT
 75+ 35c each
 1000+ 32c each
 2500+ 26c each

Metallic Foil, Gloss Clear, Gloss Black and Satine Foil only.



Toronto Totes

CODE	DESCRIPTION	SIZE (inches)	CASE PACK	PRICE/EACH	
				100+	1000+
215909 __	Small Tote	9 x 5 x 12 x 5	100	\$1.81	\$1.67
215916 __	Large Tote	16 x 6 x 14 x 6	100	\$2.66	\$2.09



FOIL PRINT*
 100+ 35c each
 1000+ 32c each
 2500+ 26c each



DIGITAL PRINT
 100+ \$2.45 each
 1000+ \$2.25 each
 300 bags minimum



15 - Black with White
 00 - White with Black

* Only Gold, Silver, White and Black foil is available for printing..

Please allow 3 - 5 weeks for printed items from approved art.



A  

B  



C  



D  



E 



F 

CODE	DESCRIPTION	SIZE (inches)	CASE PACK	PRICE/EACH	
				100+	1000+
A 21141615B	Black Tote with 4" gusset	14 x 4 x 16 x 4	100	\$2.14	\$1.52
B 21111315BW	Six Bottle Wine Tote	11.5 x 7.25 x 13 x 7.25	100	\$3.01	\$2.91
C 21141655B	Black Tote with 8" gusset	14 x 8 x 16 x 8	100	\$2.32	\$1.68
D 21141609R	Red Tote with 8" gusset	14 x 8 x 16 x 8	100	\$2.34	\$1.72
E 21141675C	Large Kraft Composite Tote	14 x 6 x 16 x 6	100	\$2.58	-
F 21081075C	Small Kraft Composite Tote	8 x 4 x 10 x 4	100	\$1.72	-



DIGITAL PRINT
 100+ \$2.45 each
 1000+ \$2.25 each
 300 bags minimum



FOIL PRINT
 100+ 35c each
 1000+ 32c each
 2500+ 26c each



SCREEN PRINT
 100+ \$1.25 each
 500+ \$1.08 each
 1000+ 90c each

Estimated lead time:
 2 - 3 weeks for printed items from approved art.

IN STOCK

Non-Woven Garment Covers

Great for resale or promotions!

CODE	SIZE (inches)	CASE PACK	PRICE/EACH UNPRINTED
A 21244015	24 x 42	100	\$3.62
B 21245415	24 x 54	100	\$5.18
C 21247215	24 x 72 + 4	100	\$8.53

Silk screen set-up charge: \$75.00

Please allow 2-3 weeks for printed items from approved art.



SCREEN PRINT

100+ \$1.25 each
500+ \$1.08 each
1000+ 90¢ each



A

Suit Bag 24" x 42"

B

Coat Bags 24" x 54"

C

Gown Bags
24" x 72" + 4"
gusset all around

LOOP FOR FOLDING OVER

In Stock
One roll, white with no print
\$373.75 any size
21214000S, 21215400S, 21217300S



CREATE YOUR OWN LOOK

Non-Woven Garment Covers

Custom Colours Available

SIZE	DESCRIPTION
24 x 42	Suit Bag
24 x 54	Coat Bag
24 x 72 + 4	Gown - Black

Please allow 14 - 16 weeks from approved art for delivery.
Minimum 1000 per size.

Pricing includes printing on one side with one colour.

BOXES

GIFT AND APPAREL



SPECIAL ORDER

IN STOCK

Malibu Magnetic Closure Gift Box

Dual purpose - great for gifting and use after.
Perfect for e-commerce business subscriptions.

- Smooth paper covering
- Magnetic closures
- Three colours and three sizes
- Inserts available via special order. Ask your representative



00 - White

11 - Pewter

15 - Black

Please allow 3-5 weeks for printed items from approved art.



FOIL PRINT

Exterior and interior lid
40/60/100+ 35¢ each
1000+ 32¢ each
2500+ 26¢ each



CODE	DESCRIPTION	SIZE (in)	CASE PACK	PRICE/EACH	
				100+	1000+
454103 __	Small	8.5 x 2.75 x 1.625	100	\$3.67	
454104 __	Medium	7.25 x 5.5 x 1.375	60	\$5.03	
454116 __	Large	10.75 x 7.125 x 1.625	40	\$5.97	

Tuckit® Folding Gift Boxes

- One piece boxes fold and tuck together for a solid bottom
- 18 sizes available • 100% recycled content (min. 35% post consumer) - kraft excluded

Bottom tucks into place for a secure fit.



12P - Kraft PinStripe

00 - Gloss White

29 - Gloss Red

55 - Gloss Black



FOIL PRINT

50/100+ 35¢ each
1000+ 32¢ each
2500+ 26¢ each

Please allow 3 - 5 weeks for printed items from approved art.

* not available in Gloss Black

100% recycled content (min. 35% post consumer) - kraft excluded

All print orders subject to set-up charges. Applicable artwork, and plate charges may apply. See page 122.



White Foldings

- Our most economical option ships flat and stores flat
- Please allow 2 - 3 weeks for printed items from approved art

Please allow 2 - 3 weeks for printed items from approved art.



FOIL PRINT

50/100+ 35¢ each
1000+ 32¢ each
2500+ 26¢ each



INK PRINT

50/100+ 34¢ each
1000+ 29¢ each
2500+ 24¢ each

CODE	DESCRIPTION	SIZE (inches)	CASE	PRICE/EACH		
				100+	1000+	
32058003	G58	Baby Mugs	3.5 x 3.5 x 2	100	\$0.27	\$0.23
32001003	G1	Mugs	4 x 4 x 4	100	\$0.28	\$0.24
32002003	G2	Cups and Saucers	6 x 6 x 4	100	\$0.39	\$0.35
32043003	G43	Bowls, etc.	10 x 8 x 4	100	\$0.53	\$0.50
32033003	G33	Bowls, etc.	10 x 10 x 6	100	\$1.31	\$1.15
32005003	G5	Teapots, etc.	8 x 8 x 5	100	\$0.80	\$0.72
32006003	G6	Teapots, etc.	8 x 8 x 8	100	\$1.17	\$1.06
32048003	G48	Fork, Knife, Spoon	13 x 4 x 2	100	\$1.45	\$1.31
32036003	G36	Casserroles	11 x 11 x 4.5	50	\$1.31	\$1.15
32013003	G13	Plates	5 x 5 x 2	100	\$0.38	\$0.32
32004003	G4	Plates	8 x 8 x 2	100	\$0.68	\$0.58
32008003	G8	Plates	11 x 11 x 2	100	\$0.81	\$0.72
32009003	G9	Plates	13.5 x 13.5 x 2	100	\$1.10	\$1.02
32040003	G40	Plates	15 x 15 x 2	100	\$1.44	\$1.30
32003003	G3	All purpose	7 x 4 x 3	100	\$0.48	\$0.43
32010003	G10	All purpose	9 x 4.5 x 4.5	100	\$0.52	\$0.46
32038003	G38	All purpose	12 x 4 x 4	100	\$0.66	\$0.60
32041003	G41	All purpose	10 x 7 x 7	100	\$1.02	\$0.96
32224003	G24*	2-Piece Boxes - Base	6 x 6 x 10	100	\$0.73	\$0.66
32124003	G24*	2-Piece Boxes - Lid		100	\$0.73	\$0.66

* Must be ordered together. Pricing shown is for base and lid combined.

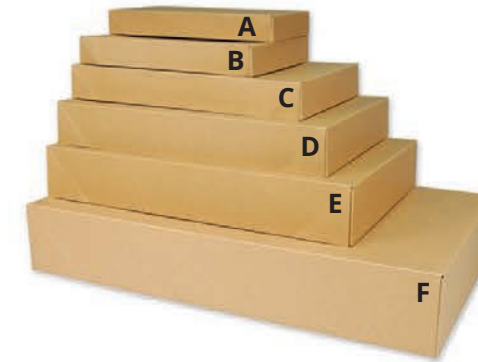

Apparel Boxes

Seven sizes* and four colours to choose from!

- Minimum order quantity is one case pack
- Please allow 2 - 3 weeks for printed in stock boxes from approved art

IN STOCK COLOURS



SPECIAL ORDER COLOUR

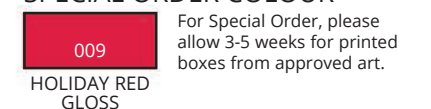

For Special Order, please allow 3-5 weeks for printed boxes from approved art.

CODE	DESCRIPTION	CASE SIZE (inches)	PACK	WHITE PRICE /EACH		KRAFT PINSTRIPE PRICE/EACH		COLOURS PRICE/EACH	
				100+	1000+	100+	1000+	100+	1000+
A 32072 ___	Glove/Sock*	11.5 x 5.5 x 1.5	100	\$1.47	\$1.22	\$1.63	\$1.36	—	—
B 32073 ___	Lingerie/T-Shirt	11.5 x 8.5 x 1.625	100	\$1.65	\$1.37	\$1.70	\$1.42	\$2.98	\$2.48
C 32075 ___	Shirt	15 x 9.5 x 2	100	\$1.81	\$1.51	\$1.92	\$1.60	\$4.15	\$3.45
D 32076 ___	Sweater/Dress	17 x 11 x 2.5	50	\$3.05	\$2.55	\$3.22	\$2.68	\$5.77	\$4.81
E 32077 ___	Jacket/Robe	19 x 12 x 3	50	\$4.07	\$3.39	\$3.78	\$3.27	\$6.65	\$5.76
F 32078 ___	Coat/Gown	24 x 14 x 4	25	\$6.48	\$5.61	\$6.80	\$5.89	\$10.01	\$8.67
G 32071 ___	Sweater (white only) (not shown)	15 x 11 x 4.5	50	\$4.91	\$4.24	—	—	—	—

* Kraft pinstripe/White only



FOIL PRINT

25/50/100+ 35¢ each
1000+ 32¢ each
2500+ 26¢ each



INK PRINT

25/50/100+ 34¢ each
1000+ 29¢ each
2500+ 24¢ each

All print orders subject to set-up charges. Applicable artwork, and plate charges may apply. See page 122.

CREATE YOUR OWN LOOK

E-Commerce



CREATE YOUR OWN LOOK

Eco-Friendly, Recyclable
E-Commerce Packaging



Custom E-Commerce Gift Boxes

Go above and beyond to impress customers and exceed their expectations by delivering more than just a product, but also an experience.

- Please allow 12 - 14 weeks for printed items from approved art

SIZE (inches)

10 x 6 x 4
11.125 x 8.75 x 4
14.5 x 7.25 x 5
17 x 12 x 4.25
17.125 x 11.125 x 2

NO PLATE CHARGES!

Custom Poly Mailers

- 2.0 mil co-extruded LDPE film
- White exterior with black interior
- 2" adhesive lip
- Plate charges apply
- Please allow 12 - 14 weeks for printed items from approved art

SIZE (inches)

9 x 12 + 2
12 x 15 1/2 + 2
14 1/2 x 19 + 2
19 x 24 + 2

OTHER TYPES OF MAILERS AVAILABLE:

Product Description	Minimum Qty
Recycled Poly Mailers	25,000+
Padded Paper Mailers	40,000+
Paper Apparel Mailers	10,000+
Rigid Paper Mailers	10,000+
Bubble Poly Mailers	25,000+



50% Recycled Shell
Made in the US

Ask Your Representative For Details On Personalizing Your E-Commerce Mailers

10,000 minimum
1, 2 or 4 colour process. One or both sides



Create Your Own Look:

Choose your box style.
Send us your artwork.
For 100% full colour design, speak to your sales representative.

IN STOCK

Available for immediate shipment.

Deliver the 'in-store' experience to your customer's door.



Gift and Apparel Ecommerce

- Reversible kraft with oyster or black interior
- Study E Flute for safe delivery in 3 sizes
- Pack flat with 50 pieces/carton

CODE	SIZE (inches)	CASE	OYSTER/KRAFT PRICE/EACH			BLACK/KRAFT PRICE/EACH		
			50+	500+	1000+	50+	500+	1000+
451009 ___	10.25 x 9.062 x 4.375	50	\$2.34	\$2.08	\$1.87	\$2.69	\$2.39	\$2.16
451511 ___	15.562 x 11.062 x 4.562	50	\$3.33	\$2.81	\$2.55	\$3.88	\$3.28	\$2.93
451612 ___	16.937 x 12.625 x 6.5	50	\$4.31	\$3.89	\$3.45	\$4.96	\$4.47	\$3.96

Add a Special Order Full Colour Seal. See page 120.

Add a customized In Stock Seal. See page 118.

Enquire about our Digital Print option!

Jewellery Boxes

For Geo, Velocity and Horizon packaging.

- Reversible kraft boxes with black or metallic bronze interior
- Black flock inserts available to fit Gold Galleria, Horizon, Geo or Velocity jewellery packaging*
- Minimum case pack 25



* Inserts can be special ordered to fit any of our other jewellery packaging collections. Contact your sales representative for a quote.
Minimum order: 100 per size



FOIL PRINT
25+ 35¢ each
1000+ 32¢ each
2500+ 26¢ each

Please allow 2 - 3 weeks for printed items from approved art.

CODE	DESCRIPTION	SIZE (inches)	PRICE/EACH		
			25+	250+	1000+
450505 ___	Small Ecom Box	5.75 x 5.75 x 2.5	\$1.54	\$1.46	\$1.22
451010 ___	Large Ecom Box	10.25 x 10.25 x 2.5	\$3.08	\$2.83	\$2.56
Gold Galleria/Horizon Inserts					
69221003H	Ring to fit small box		\$0.57	\$0.52	\$0.38
69632003H	T-pad to fit small box		\$0.57	\$0.52	\$0.38
69684003H	Utility to fit small box		\$0.57	\$0.52	\$0.38
69693003H	Bracelet to fit large box		\$0.93	\$0.74	\$0.66
Geo Inserts					
69221153G	Ring to fit small box		\$0.57	\$0.52	\$0.38
69283153G	T-pad to fit small box		\$0.57	\$0.52	\$0.38
69293153G	Bracelet to fit large box		\$0.93	\$0.74	\$0.66
69273153G	Necklace to fit large box		\$0.93	\$0.74	\$0.66
Velocity Inserts					
69321153V	Ring to fit small box		\$0.57	\$0.52	\$0.38
69383153V	Utility pad to fit small box		\$0.57	\$0.52	\$0.38
69393153V	Bracelet to fit large box		\$0.93	\$0.74	\$0.66
69373153V	Necklace to fit large box		\$0.93	\$0.74	\$0.66

All print orders subject to set-up charges. Applicable artwork, and plate charges may apply. See page 122.

IN STOCK

Recyclable Ecommerce Mailer

- Natural brown kraft paper
- 150 gsm recycled paper - 40% PCW
- Strong and flexible with 3" gussets
- 1 sku - customizable to sizes



CODE	SIZE (inches)	CASE PACK	PRICE/EACH	
			200+	1000+
52524512	20.5 x 3 x 17.75	200	\$1.03	\$0.91

FOIL PRINT

200+	35¢ each
1000+	32¢ each
2500+	26¢ each

ECO-FRIENDLY – “BE PROUD OF THE WAY YOU SHIP”



A Recycled Poly Mailers

- IN STOCK -

CODE	SIZE (in)	CASE	PRICE/EACH	
			1+	4+
52091286	9 x 12	1000	\$0.57	\$0.54
52101386	10 x 13	1000	\$0.60	\$0.57
52121586	12 x 15.5	500	\$0.79	\$0.75

- SPECIAL ORDER -

CODE	SIZE (in)	CASE	PRICE/EACH	
			1+	4+
52060986	6 x 9	1000	\$0.41	\$0.39
52071086	7.5 x 10.5	1000	\$0.48	\$0.45
52141986	14.5 x 19	250	\$1.33	\$1.26
52192486	19 x 24	125	\$2.16	\$2.04
52242486	24 x 24	125	\$2.92	\$2.77

B Padded Paper Mailers

- IN STOCK -

CODE	SIZE (in)	CASE	PRICE/EACH	
			1+	4+
52060976	6 x 9	250	\$0.87	\$0.83
52081176	8.5 x 11	100	\$1.38	\$1.31

- SPECIAL ORDER -

CODE	SIZE (in)	CASE	PRICE/EACH	
			1+	4+
52101576	10.5 x 15	2 100	\$2.04	\$1.93

C Paper Apparel Mailers

- IN STOCK -

CODE	SIZE (in)	CASE	PRICE/EACH	
			1+	4+
52101375	10 x 13	250	\$1.46	\$1.39
52121575	12 x 15.5	150	\$1.96	\$1.85
52101975	10.5 x 4 x 19	100	\$2.32	\$2.20

- SPECIAL ORDER -

CODE	SIZE (in)	CASE	PRICE/EACH	
			1+	4+
52070975	7 x 9	250	\$0.95	\$0.90

D Rigid Paper Mailers

- IN STOCK -

CODE	SIZE (in)	CASE	PRICE/EACH	
			1+	4+
52061012	6 x 10	500	\$0.68	\$0.65
52061212	6 x 2.5 x 12	500	\$0.98	\$0.93
52091412	9.5 x 14.5	250	\$1.19	\$1.12

- SPECIAL ORDER -

CODE	SIZE (in)	CASE	PRICE/EACH	
			1+	4+
52081212	8.5 x 12	250	\$0.90	\$0.85
52101612	10.5 x 16	250	\$1.43	\$1.35
52121912	12.5 x 19	250	\$1.62	\$1.53

For more product information on recyclability and material content, visit gunthermele.com



FOIL PRINT

100+	35¢ each
1000+	32¢ each
2500+	26¢ each

PAD PRINT

100+	35¢ each
1000+	32¢ each
2500+	26¢ each

INK PRINT

100+	34¢ each
1000+	29¢ each
2500+	24¢ each



FINISHING TOUCHES

RIBBON, TISSUE, WRAP AND SEALS



All print orders subject to set-up charges. Applicable artwork, and plate charges may apply. See page 122.

All print orders subject to set-up charges. Applicable artwork, and plate charges may apply. See page 122.

IN STOCK

Inspirations Gift Wrap

Inspirations
Giftwrap

By Gunther Mele

Available for immediate shipment.



Inspirations
Giftwrap

By Gunther Mele

Available for immediate shipment.



IN STOCK

Inspirations Gift Wrap



GIFT WRAP

GIFT WRAP

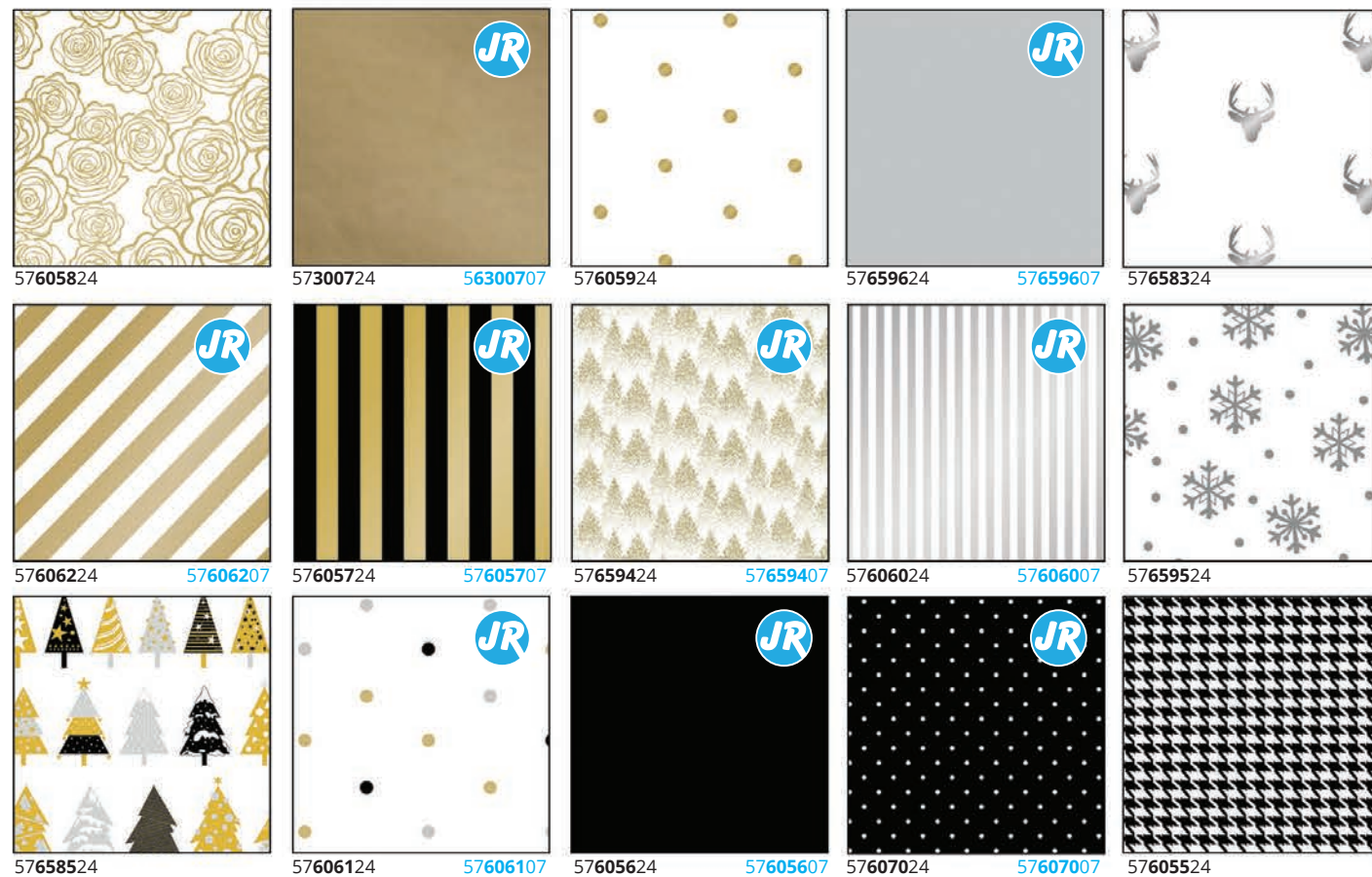

24" x 417' - 1/2 Ream Roll
\$103.88 Code # 57 ____ 24
each

8" x 150' - Jewellers Rolls **\$42.40** Code # 57 ____ 07
each

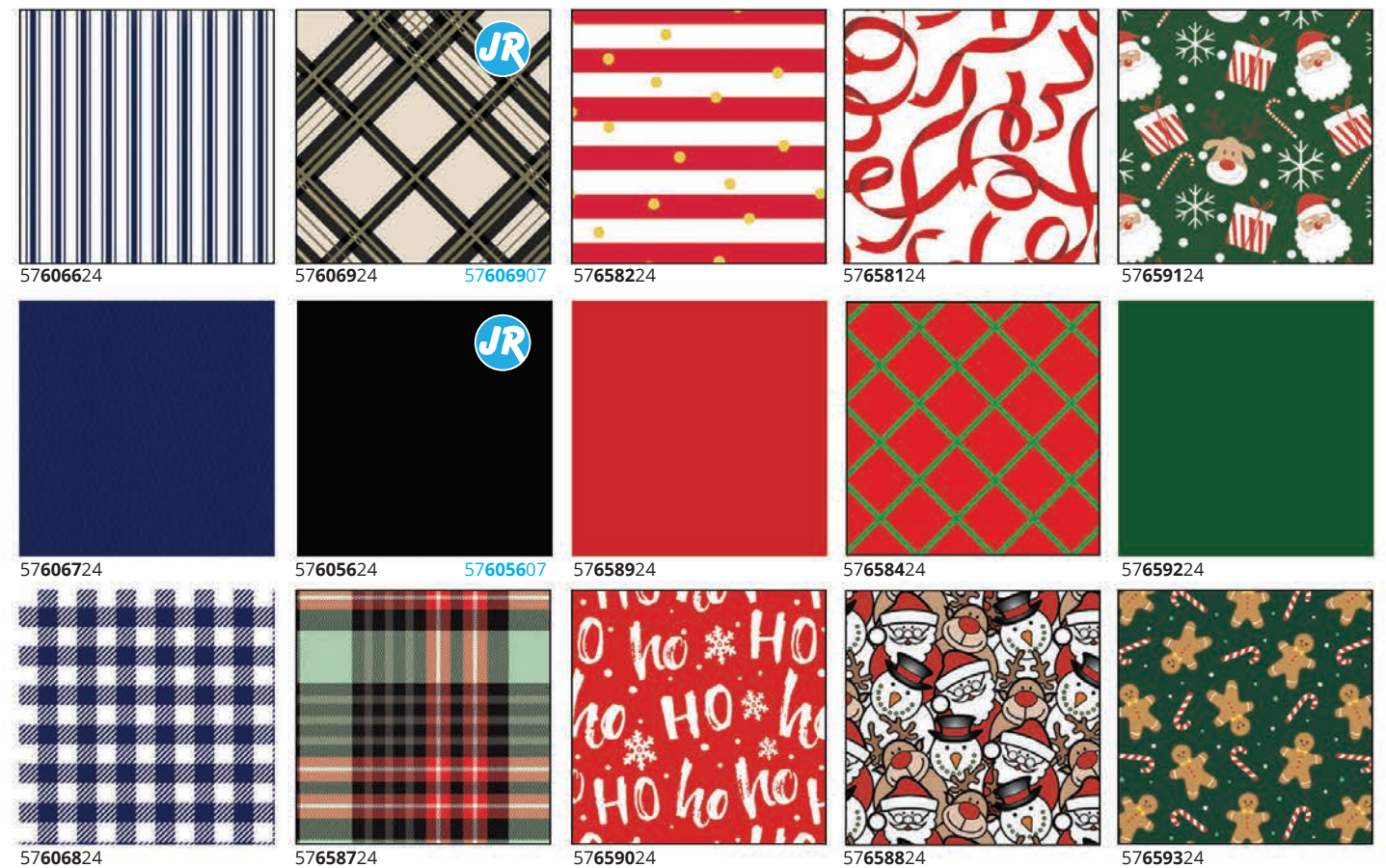

24" x 417' - 1/2 Ream Roll
\$103.88 Code # 57 ____ 24
each

8" x 150' - Jewellers Rolls **\$42.40** Code # 57 ____ 07
each

SPECIAL ORDER

Sullivan Designs Seasonal

Please allow 4 - 6 weeks for shipment.

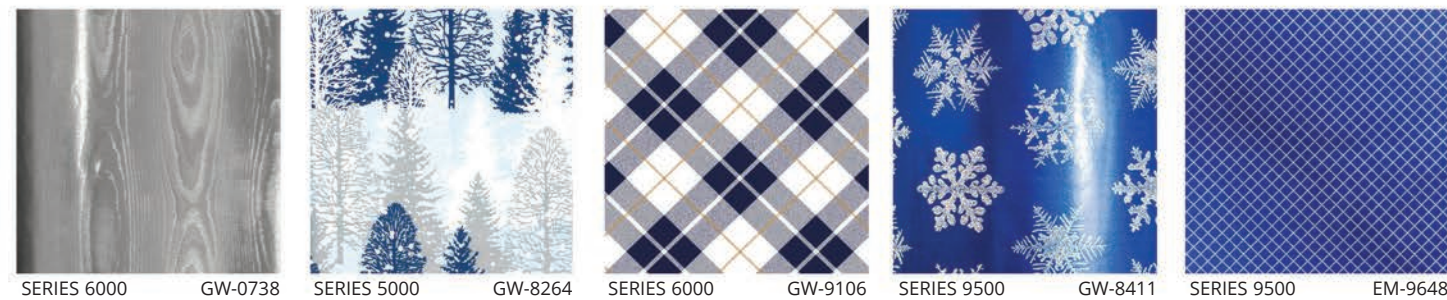

SPECIAL ORDER

Sullivan Designs Every Day

Please allow 4 - 6 weeks for shipment.



Additional custom order designs available to choose from. Contact your area sales representative for more info.

SULLIVAN designs available in 1/2 Ream Rolls and Full Ream Rolls

NOTE: All Sullivan gift wrap orders must include GW design code.

MINIMUM ORDER: 1 Roll per design (15" rolls must be ordered in multiples of 2 rolls per design)

SLITTING CHARGE: A slitting charge of \$25.00 applies to each individual roll. No more than two slits per roll; (2 slits = \$25.00)

Pricing Level	15H	24H	30H	15F	24F	30F
	Half Ream 15" x 417"	Half Ream 24" x 417"	Half Ream 30" x 417"	Full Ream 15" x 833"	Full Ream 24" x 833"	Full Ream 30" x 833"
2000 Series	\$170.89	\$273.18	\$314.72	\$297.61	\$484.80	\$568.15
5000 Series	\$199.19	\$321.88	\$370.56	\$352.83	\$580.60	\$677.83
6000 Series	\$234.52	\$383.50	\$441.23	\$425.56	\$691.18	\$819.30
9000 Series	\$274.24	\$451.80	\$520.65	\$502.85	\$840.44	\$977.87
9500 Series	\$302.75	\$501.32	\$577.68	\$560.02	\$939.62	\$1092.21

View our entire Selection online at GUNTHERMELE.COM

Jewellers Rolls

Size: 7.375" x 150"

\$80.45/roll

Minimum order 1 roll.
JR150 - Jeweller Roll suffix code.

Counter Rolls

Size: 24" x 100"

\$110.44/roll

Minimum order 1 roll.
-24X100 - Counter Roll suffix code.
Note: Sullivan does not allow counter roll slitting.

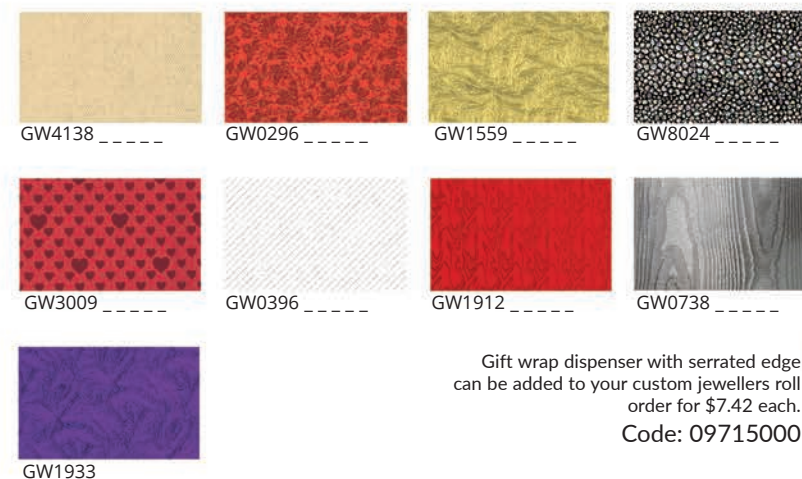

Gift wrap dispenser with serrated edge can be added to your custom jewellers roll order for \$7.42 each.
Code: 09715000



SPECIAL ORDER

Shamrock Designs Seasonal

Please allow 4 - 6 weeks for shipment.



SPECIAL ORDER

Shamrock Designs Every Day

Please allow 4 - 6 weeks for shipment.

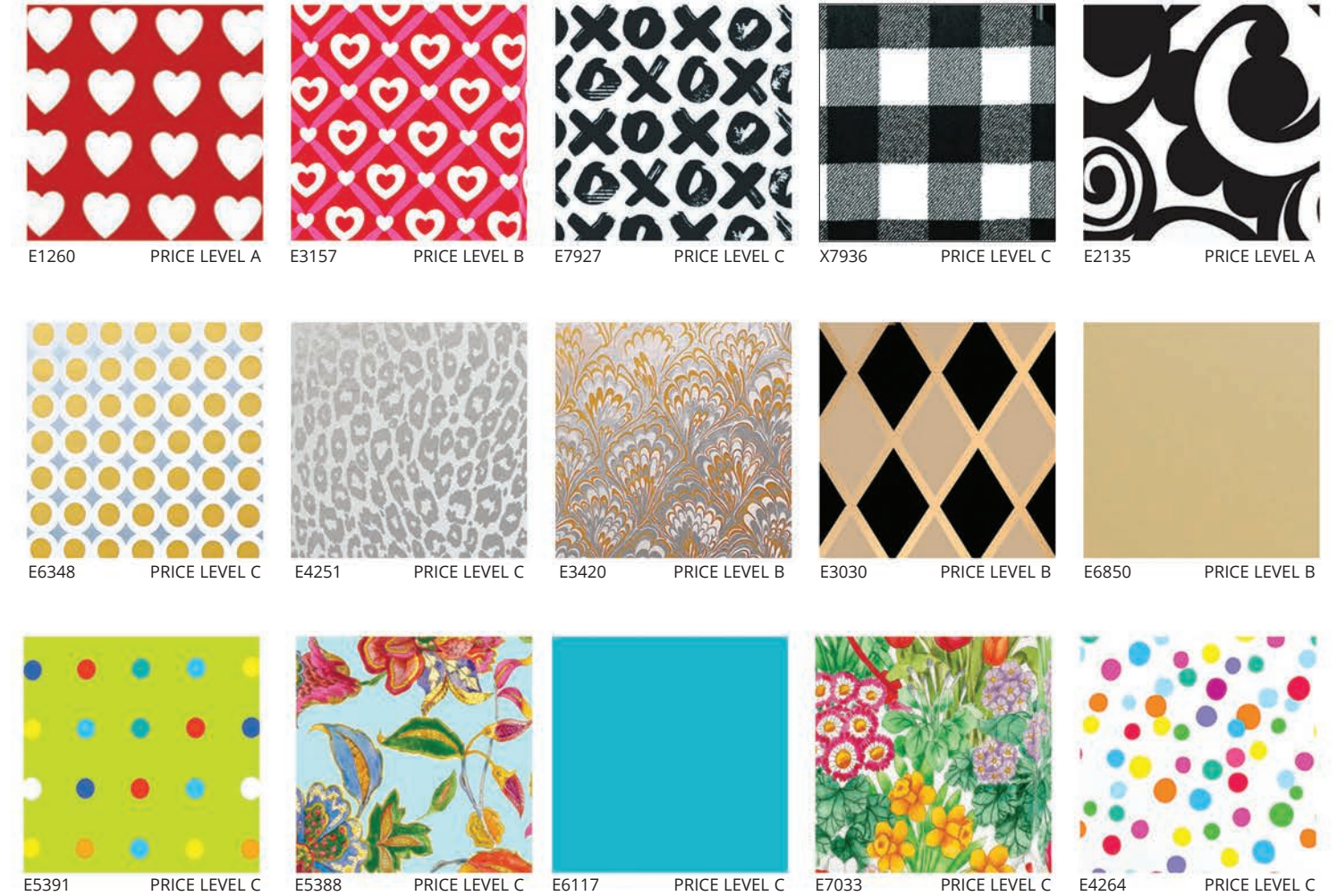

Additional custom order designs available to choose from. Contact your area sales representative for more info.

Shamrock designs available in Cutter Boxes, 1/2 Ream Rolls and Full Ream Rolls

View our entire
Selection online at
GUNTHERMELE.COM

NOTE: All Shamrock gift wrap orders must include design code.

MINIMUM ORDER: 1 Roll

Jewellers Rolls also available. Most are minimum 3 rolls per design.*

SLITTING CHARGE: A slitting charge of \$25.00 applies to each individual roll. (no more than two slits per roll - 2 slits = \$25.00)

Contact your sales representative for details.* Select designs available in 1 roll minimums.

Pricing Level	7J	24C	18H	24H	30H	36H	18F	24F	30F	36F
	Jewellers Roll 7.375"x100'	Cutter Box 24" x 100'	Half Ream 18" x 417'	Half Ream 24" x 417'	Half Ream 30" x 417'	Half Ream 36" x 417'	Full Ream 18" x 833'	Full Ream 24" x 833'	Full Ream 30" x 833'	Full Ream 36" x 833'
A	\$31.75	\$63.02	\$199.11	\$180.55	\$287.57	\$328.54	\$324.10	\$305.66	\$458.55	\$551.34
B	\$38.98	\$77.50	\$246.96	\$228.52	\$341.73	\$413.62	\$423.66	\$404.98	\$607.47	\$732.35
C	\$46.33	\$92.32	\$283.95	\$265.40	\$398.10	\$482.36	\$493.56	\$475.12	\$712.74	\$857.00
D	\$49.95	\$99.79	\$283.95	\$287.57	—	—	\$541.41	\$522.97	—	—

CREATE YOUR OWN LOOK

• Please allow 6 - 8 weeks for printed items from approved art.



Printed Tissue: Pick a PMS print colour and we will match it.

– See page 105 for Special Order Tissue Colours!

CODE	DESCRIPTION	SIZE (in)	PACKAGED	PRICE/EACH	
				10 REAMS	30 REAMS
20869000G	White	20 X 30	480	\$119.46	\$103.36
20869000M	Coloured	20 x 30	480	\$171.24	\$148.17
20869000GK	Kraft	20 x 30	480	\$119.46	\$103.36
20869001M	Metallic SS*	20 x 30	200	\$283.39	\$268.74

* SS - single sided

Print included in price of tissue.

Minimum 10 reams. Note: Plates extra \$310.00 (per colour).
Ships in approximately 6 - 8 weeks.

For metallic ink print: add 10% to the price above.
For > 50% ink coverage, an additional \$10 per ream.
All custom orders subject to a +/-10% over/under run.

Custom Printed
White Tissue – 10 Reams
\$1194.60

IN STOCK

Available for immediate shipment.

Spotlight Tissue Colours

CODE	DESCRIPTION	SIZE (in)	PKG	PRICE/EACH		
				1 - 4	5+	25+
20819290S	White Economy	19 x 29	480	\$20.78	\$17.80	\$14.84
208551_G	Spotlight on Value (colours)	20 x 30	480	\$39.74	\$39.74	\$39.74
208559_G	Spotlight on Value (metallic)	20 x 30	200	\$71.55	\$70.22	\$68.90
20850102	#1 White Economy	19 x 14.5	480	\$10.00	\$8.75	\$7.19
20851800	#1 White Bleached	18 x 9 dia.	1 roll	\$118.72/roll		
20852000	#1 White Bleached	20 x 9 dia.	1 roll	\$146.92/roll		

12 in stock tissue colours to choose from. Plus check out our assorted Pre-Pack!



Spring Assortment Pre-Pack

20855100G - 20 x 30" - \$21.25/Pack
Contains 100 of each:
Green, Lemon, Tangerine, Pink, Blue.

10 FOREST GREEN	14 DANDELION	16 ORANGE	19 BRIGHT LIME	56 ZIPPY GRAPE	21 HOT PINK	07 GOLD
60 EMERALD	66 BURGUNDY	* Hot Pink (21) and Burgundy (66) are \$52.60/each				08 SILVER

SPECIAL ORDER

Unprinted Tissue

Unprinted, minimum 1 ream (per colour).
Ships in approximately 4 - 6 weeks.

CODE	DESCRIPTION	SIZE (in)	Packaged	PRICE/REAM	
				1 REAM	25+ REAMS
20899_--	Special Order Colours	20 x 30	480 sheets	\$51.16	\$44.88

NE-100 LIGHT PINK	NE-110 PINK	NE-120 CORAL ROSE	NE-124 AZALEA	NE-126 SCARLET	NE-130 RED	NE-131 DEEP SCARLET	NE-145 FUCHSIA	NE-148 HOT PINK	NE-150 CERISE	NE-155 ZIPPY GRAPE
NE-160 PURPLE	NE-164 SANDSTONE	NE-165 BURGUNDY	NE-170 DUBONNET	NE-190 PEACH	NE-195 TANGERINE	NE-200 ORANGE	NE-210 LIGHT YELLOW	NE-220 YELLOW	NE-222 DANDELION	NE-223 OATMEAL
NE-226 POPPY	NE-230 GOLDENROD	NE-235 PISTACHIO	NE-246 EMERALD	NE-247 JADE	NE-245 PALE MINT	NE-250 MID GREEN	NE-251 GROOVY GREEN	NE-255 BRIGHT LIME	NE-265 TEAL	NE-266 BALSAM
NE-269 OASIS GREEN	NE-270 DARK GREEN	NE-273 FESTIVE GREEN	NE-274 CEDAR GREEN	NE-275 FOREST GREEN	NE-277 TAPESTRY GREEN	NE-278 AZURE	NE-279 OXFORD BLUE	NE-281 BLUE BREEZE	NE-300 TURQUOISE	NE-305 CERULEAN
NE-306 BRILLIANT BLUE	NE-308 SAPPHIRE	NE-310 DARK BLUE	NE-325 LILAC	NE-330 LAVENDER	NE-335 PERIWINKLE	NE-338 LILAC PERFUME	NE-340 PLUM	NE-341 RASPBERRY FIZ	NE-345 CRANBERRY	NE-347 CRÈME
NE-350 FRENCH VANILLA	NE-354 SHADOW GREY	NE-356 GRANITE	NE-357 NOBLE GOLD	NE-359 ESPRESSO	NE-360 DESERT TAN	NE-361 BERMUDA SAND	NE-362 TERRA COTTA	NE-366 BURNT SIENNA	NE-370 CHOCOLATE	NE-371 RAW SIENNA
NE-375 ANTIQUÉ BLUE	NE-382 COLONIAL BLUE	NE-385 NAVY BLUE	NE-386 MORNING MIST	NE-389 MOUNTAIN MIST	NE-390 GRAY	NE-400 BLACK	NE-410 BIRCH	NE-415 DUNE BEIGE	NE-417 PARCHMENT	

IN STOCK

Available for immediate shipment.

Curling Ribbon

See chart for available colours

CODE	PRICE/ROLL
COLOURS - 3/16" x 500 yards 148373 __	\$4.53
METALLIC - 3/16" x 250 yards 148378 __	\$12.27



2.75" Star Bows

See chart for available colours

CODE	CASE PACK	PRICE/EACH	
		200+	1000+
COLOURS - 2.75" x 17 loop 142311 __	200	\$0.19	\$0.17
METALLIC - 2.5" x 17 loop 14531107 Gold	200	\$0.19	\$0.17
14531108 Silver	200	\$0.19	\$0.17

Min: case pack



3.75" Star Bows

See chart for available colours

CODE	CASE PACK	PRICE/EACH	
		100+	1000+
COLOURS - 3.75" x 13 loop 143512 __	200	\$0.20	\$0.18
METALLIC - 3.75" x 17 loop 14551207 Gold	200	\$0.29	\$0.26
14551208 Silver	200	\$0.29	\$0.26

Min: case pack

Splendor Ribbon

See chart for available colours

CODE	PRICE/ROLL
COLOURS - 3/4" x 250 yards 141050 __	\$12.46
METALLIC - 3/4" x 100 yards 14013007 Gold	\$16.60
14013008 Silver	\$15.60



99 - Everyday Assortment Star Bows Available in 2.75" and 3.75"



98 - Christmas Assortment Star Bows Available in 2.75" and 3.75"



Metallic Star Bows Available in 2.75" and 3.75"

Color # Name	Curling Ribbon	2.75" Star Bows	3.75" Star Bows	Splendor Ribbon
00 - White				
86 - Ivory				
29 - Vanilla				
61 - Pastel Yellow				
03 - Yellow				
13 - Daffodil				
14 - Sunshine Yellow				
07 - Gold				
08 - Silver				
27 - Holiday Gold				
22 - Melon				
73 - Coral				
16 - Tropical Orange				
17 - Orange				
12 - Chocolate				
75 - Baby Pink				
01 - Pink				
80 - Primrose				
57 - Azalea				
09 - Red				
58 - Lava Red				
66 - Burgundy				
41 - Beauty				
59 - Dubonnet Rose				
28 - Orchid				
05 - Lavender				
56 - Purple				
54 - Periwinkle				
50 - Plum				
11 - Royal				
81 - Navy				
77 - Baby Blue				
02 - Light Blue				
47 - Aqua				
32 - Caribbean Blue				
55 - Robin's Egg				
25 - Turquoise				
71 - Sea Green				
18 - Celery				
74 - Spruce				
60 - Hunter				
84 - Teal				
04 - Mint				
19 - Citrus				
96 - Leaf				
30 - Celadon				
10 - Emerald				
70 - Antique Silver				
15 - Black				
07 - Metallic Gold				
08 - Metallic Silver				
09 - Metallic Red				
10 - Metallic Green				
99 - Everyday Assortment	N/A			N/A
98 - Christmas Assortment	N/A			N/A

IN STOCK

Available for immediate shipment.

Perfect Bows™

Minimum: 50 per size, per colour.

CODE	SIZE	PRICE/EACH	
		50+	1000+
140515 __	5.5" Perfect Bow	\$1.41	\$1.27



Pull Bows

Minimum: 100 per size, per colour.

CODE	SIZE	STANDARD COLOURS		METALLIC COLOURS	
		100+	1000+	100+	1000+
132000 __	Petite 2" Bows	\$0.25	\$0.22	\$0.40	\$0.37
134000 __	Std. 4" Bows	\$0.42	\$0.38	\$0.68	\$0.63



Mini Metallic Star Bows

252 per tub

CODE	DESCRIPTION	PRICE/TUB
14121099	Assorted	\$39.60
14121017	Gold	\$39.60
14121008	Silver	\$39.60



Matte Wraphia™

CODE	SIZE	PRICE/ROLL
148367 __	100 yds	\$10.22

Paper Roll/Ream Dispenser and Tape

CODE	DESCRIPTION	PRICE
09850124	Paper Roll/Ream Roll dispenser - 24" rack	\$80.04 each



Cellophane (1.0mil)

CODE	DESCRIPTION	SIZE	PRICE/ROLL
16400506	Clear Cellophane	40" x 100'	\$20.64
16300506	Clear Cellophane	40" x 300'	\$57.10

Ribbon Shredder

CODE: 09878600
PRICE: \$8.61 each



Curling Ribbon Roll Dispenser

CODE: 09850100
PRICE: \$136.35 each



Holds 12 Rolls

SPECIAL ORDER

SPECIAL ORDER

RIBBON

RIBBON

Printed Satin Ribbon

See chart to the right for ribbon colours.

Single Face Satin

WIDTH	CODE	PRICE/EA
3/8" x 100 yd roll	14150002	\$47.56
5/8" x 100 yd roll	14150003	\$50.88
7/8" x 100 yd roll	14150005	\$59.21
1-1/2" x 100 yd roll (2 x 50 yd rolls)	14150015	\$95.11

500 yard minimum per width. Note: Plates extra \$77.00 (per colour).



Contact your sales representative.



5/8" Single Face Satin Ribbon with Foil Print

Please allow 3-4 weeks for printed items from approved art.

Foil Print Colours

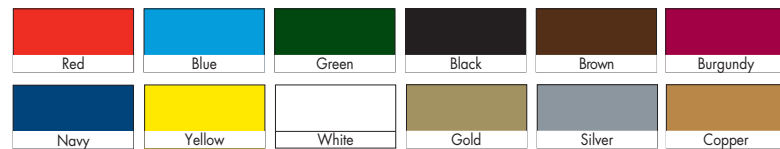

FOIL PRINT
Included in price of ribbon

Unprinted Satin and Grosgrain Ribbon

Lead time please allow 4-6 weeks for shipment. SPECIAL ORDER

See chart to the right for ribbon colours.

Single Face Satin

WIDTH	CODE	PRICE/EA
3/8" x 100 yd roll	14031 ___	\$22.38
5/8" x 100 yd roll	14032 ___	\$24.00
7/8" x 100 yd roll	14033 ___	\$39.66
1-1/2" x 50 yd roll	14034 ___	\$29.74

1 roll minimum.

Grosgrain

WIDTH	CODE	PRICE/EA
3/8" x 100 yd roll	14160 ___	\$22.56
5/8" x 100 yd roll	14161 ___	\$27.33
7/8" x 100 yd roll	14162 ___	\$40.36
1-1/2" x 50 yd roll	14170 ___	\$27.53

While we strive for accuracy in our catalogue, actual product may be slightly different than pictured.

Please allow 3-4 weeks for printed items from approved art.

COLOUR NUMBER AND NAME	3/8"		5/8"		7/8"		1-1/2"		COLOUR NUMBER AND NAME
	Single Face Satin	Grosgrain	Single Face Satin	Grosgrain	Single Face Satin	Grosgrain	Single Face Satin	Grosgrain	
029 - White									462 - Royal Orchid
007 - Shell Grey									464 - Delphinium
012 - Silver									465 - Purple
015 - Grey									470 - Regal Purple
022 - Pewter									473 - Amethyst
028 - Antique White									528 - Lemon Grass
813 - Oyster									530 - Mint
016 - Portobello									533 - Jungle Green
030 - Black									547 - New Chartreuse
115 - Powder Pink									548 - Kiwi
117 - Light Pink									550 - Apple Green
150 - Pink									558 - Leaf
156 - Hot Pink									567 - Spring Moss
175 - Shocking Pink									570 - Moss
187 - Azalea									580 - Emerald
241 - Living Coral									586 - New Neon Green
250 - Red									587 - Forest Green
252 - Hot Red									617 - Baby Maize
260 - Scarlet									640 - Lemon
275 - Wine									645 - Daffodil
277 - Burgundy									650 - Maize
285 - Plum									660 - Yellow Gold
305 - Light Blue									675 - Gold
331 - Dusty Blue									690 - Old Gold
312 - Blue									722 - Burnt Sienna
315 - Navajo Turquoise									743 - Ginger
329 - Cobalt									750 - Torrid Orange
340 - Turquoise									789 - Sherry
343 - Tornado Blue									790 - Currant
350 - Royal									810 - Ivory
352 - Electric Blue									815 - Cream
353 - Century Blue									825 - Natural
365 - Light Navy									835 - Tan
370 - Navy									841 - Khaki
412 - Purple Haze									850 - Brown
430 - Light Orchid									866 - Coffee
450 - Orchid									

All print orders subject to set-up charges. Applicable artwork, and plate charges may apply. See page 122.

IN STOCK

In stock and ready to ship.

Simply Sheer Asiana Ribbon

Monofilament-Edge



CODE	SIZE	PRICE/ROLL
149435 __	7/8" x 100 yards	\$16.01
149436 __	1 1/2" x 100 yards	\$17.67

• minimum order: one roll.



Can be special ordered in additional colours!

SPECIAL ORDER

Please allow 4 - 6 weeks for shipment.

Contessa Ribbon

Wire-Edge
Single Face Satin



CODE	SIZE	PRICE/ROLL
14163 ___	1 1/2" x 25 yards	\$18.05
*14164 ___	2 1/4" x 25 yards	\$27.08

• minimum order: one roll.



* 2-1/4" is only available in 029-White, 260-Scarlet and 810-Ivory.

Encore Ribbon

Wire-Edge



CODE	SIZE	PRICE/ROLL
141650 __	5/8" x 25 yards	\$7.58
141660 __	1 1/2" x 25 yards	\$14.46
141670 __	2 1/2" x 25 yards	\$22.01

• minimum order: one roll.

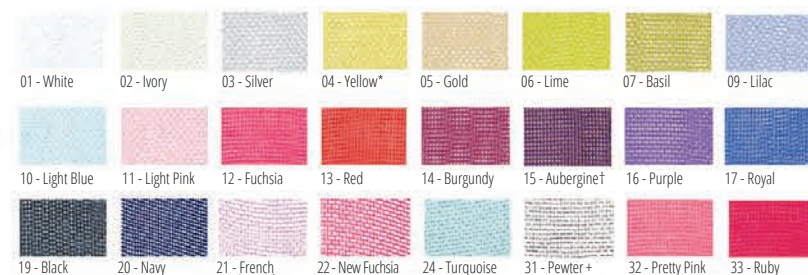

* not available in 5/8"
† not available in 2 1/2"

Garbo Ribbon



CODE	SIZE	PRICE/ROLL
14168 ___	5/8" x 100 yards	\$61.13
14169 ___	1 1/2" x 50 yards	\$48.38

• minimum order: one roll.



* not available in 5/8"
† not available in 1 1/2"



Please allow 4 - 6 weeks
for printed items from
approved art.

CREATE YOUR OWN LOOK

Raised Ink Printing

See chart below for ribbon colours.

Pick your own colours for raised print - NO PLATE CHARGE

Available in: 5/8" x 100 yd roll, 7/8" x 100 yd roll, 1-1/2" x 50 yd roll
40 roll minimum for all printed ribbon.

Sheer Ribbon Colours

All colours are available in all sizes. See page 115 for single face satin and grosgrain colour availability.



Single Face Satin Ribbon with Raised Print



Sheer Ribbon with Raised Print



Grosgrain Ribbon with Raised Print



Customized Seals-Foil Printed

CODE	One colour foil print/each SIZE	SPECIAL ORDER Two colour/each		SPECIAL ORDER Acetate 1 colour/each		SPECIAL ORDER Acetate 2 colour/each			
		2000+	5000+	2000+	5000+	2000+	5000+		
25 4 digit label code 2 digit label colour	A	\$0.12	\$0.10	\$0.1577	\$0.1242	\$0.1792	\$0.1393	\$0.2062	\$0.1598
	B	\$0.13	\$0.12	\$0.1685	\$0.1307	\$0.2149	\$0.1685	\$0.2473	\$0.1976
	C	\$0.15	\$0.14	\$0.1803	\$0.1501	\$0.2750	\$0.1977	\$0.2894	\$0.2354
	D*	\$0.17	\$0.15	\$0.1922	\$0.1598	\$0.3175	\$0.2538	\$0.3424	\$0.2743

\$80 plate charge

NO PLATE CHARGES

Label Colours Available:



* D sized Seals and Clear print are SPECIAL ORDER.
See foil chart on inside back cover of catalogue for available print colours.



FOIL PRINT
Included in the price.
Please allow 2-3 weeks for printing.

Pre-printed Labels



CODE	SIZE	CASE	PRICE/EACH	
			1000+	5000+
25401007S	5/8 x 3/8"	1000	\$0.13	\$0.12
25401407S	5/8 x 3/8"	1000	\$0.13	\$0.12
25406208S	5/8 x 3/8"	1000	\$0.13	\$0.12
25401007V	3/4" oval	1000	\$0.13	\$0.12
25401407V	3/4" oval	1000	\$0.13	\$0.12
25406008V	3/4" oval	1000	\$0.13	\$0.12

1000/box minimum order - 1 box of 1000.

Available for immediate shipment.

For a no-print solution, order our in stock embossed seals.

Embossed Seals

CODE	SIZE	PRICE/EA
Gold 08701207	1.5" dia.	\$0.09
Silver 08701208	1.5" dia.	\$0.09

ACTUAL EMBOSSED PATTERN 1.5" DIA.

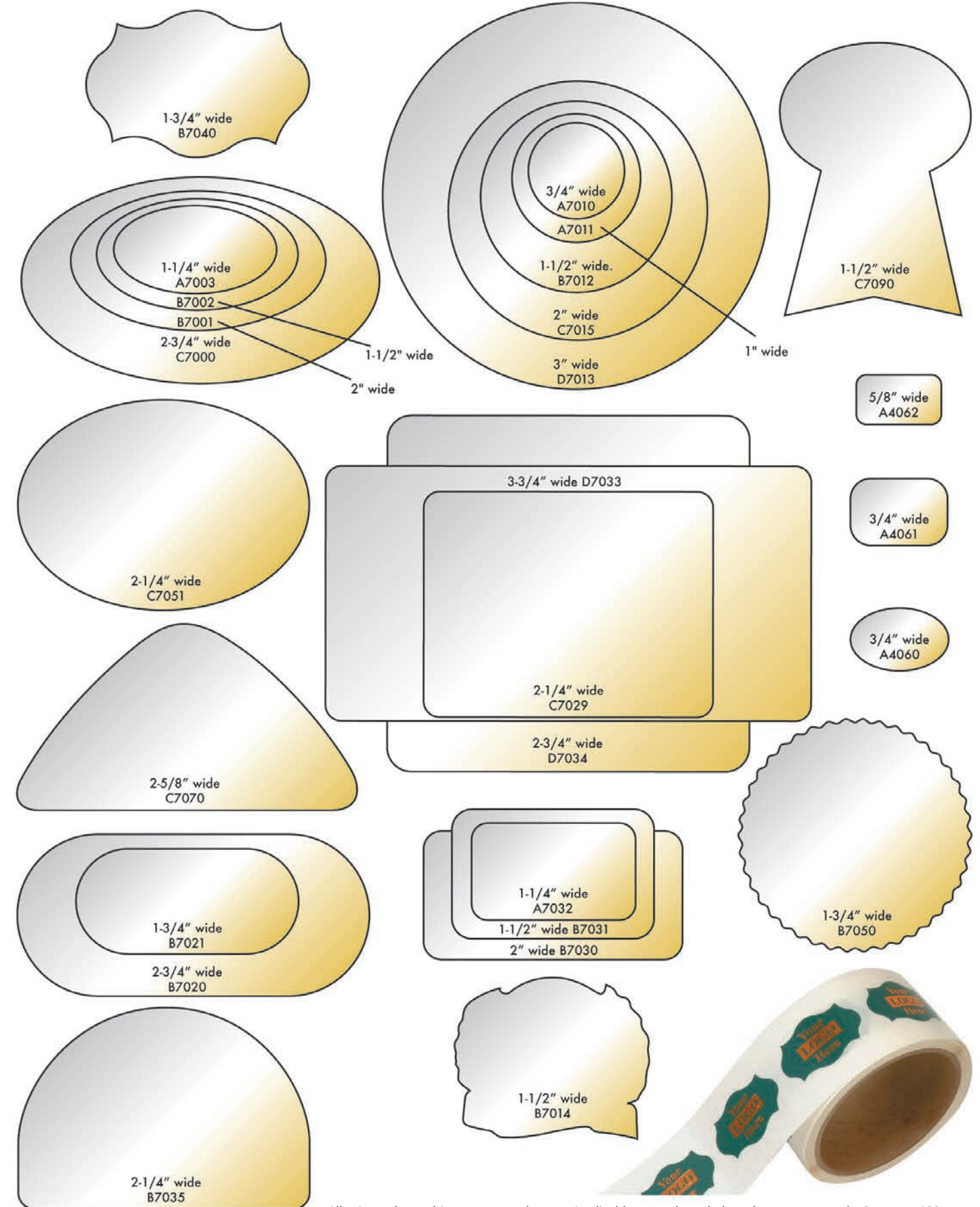

All print orders subject to set-up charges. Applicable artwork, and plate charges may apply. See page 122.

All print orders subject to set-up charges. Applicable artwork, and plate charges may apply. See page 122.

SPECIAL ORDER

SPECIAL ORDER

Please allow 4 - 6 weeks for printing from approved art. NO PLATE CHARGE!

Custom Full Colour Seals

Full colour, edge to edge print.
Thirty sizes to choose from.
"Picture Perfect" Seals

Speak with
your Sales
Representative
to order.

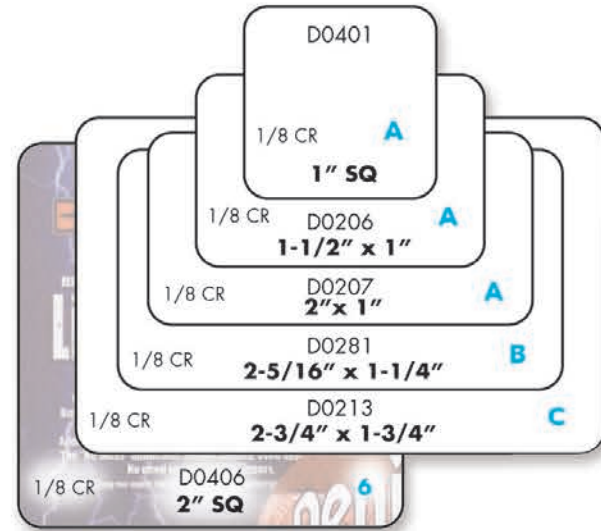

Please allow 4 - 6 weeks for printing from approved art.
NO PLATE CHARGE!

CUSTOM FULL COLOUR SEALS

CUSTOM FULL COLOUR SEALS

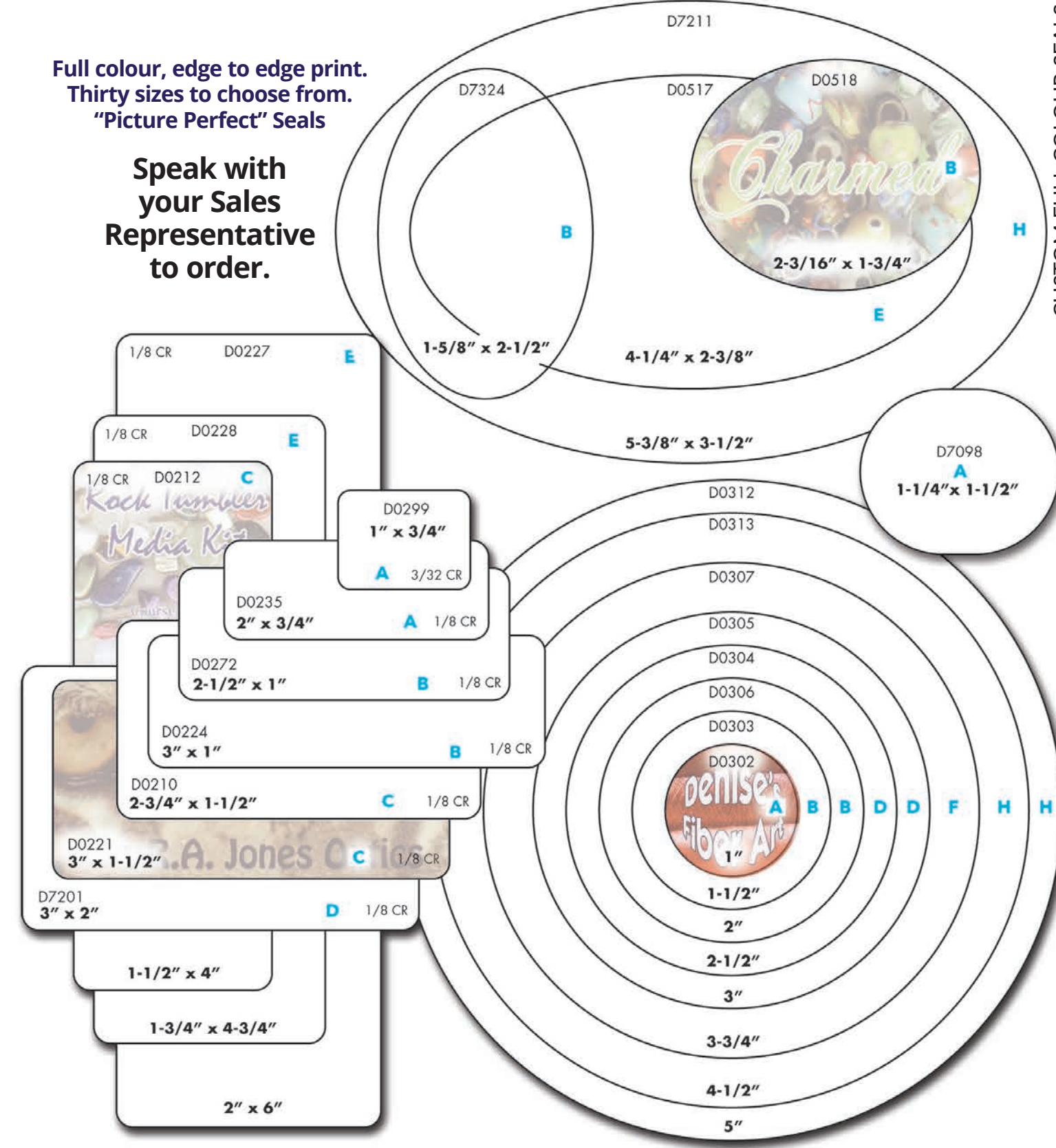
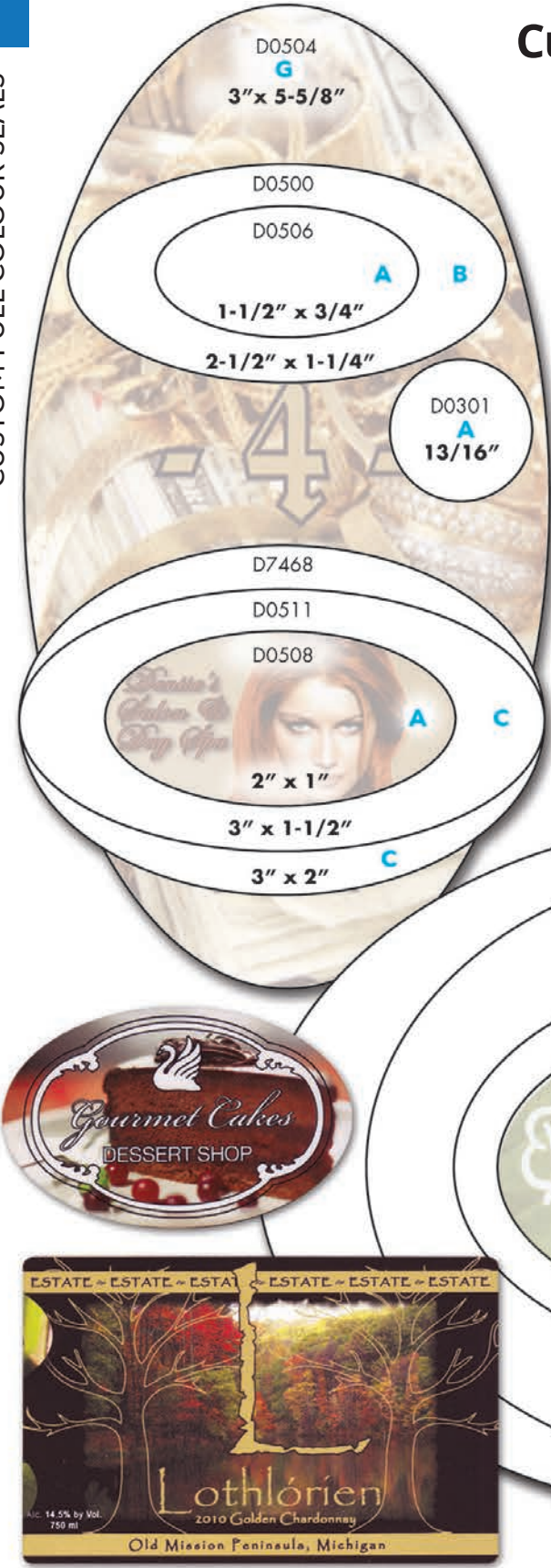





PRINTING INFORMATION

Have your name and logo printed... it's easy!

1. Select your box or bag style, colour and size.

2. Choose the printing method you wish to use.

-  A. **FOIL PRINTING:** Foil is applied to the bag or box using a combination of heat and pressure on a magnesium print plate to create an elegant appearance. Choice of Metallic or Matte foils. Cost of Foil Printing Print plate per size and colour - \$80.00 (maximum 30 square inches)
-  B. **PAD PRINTING:** Ink is applied to smooth surfaces allowing us to print your logo in places never before possible. Cost of Pad Print plate per size and colour - \$104.50 (maximum 3.75 square inches)
-  C. **INK PRINTING:** Ink is applied to the box or bag using a rubber printing plate. This method is ideal for larger coverage prints and is economically priced. Cost of Ink Printing Plate per size per colour starting at \$137.50. (maximum 25 square inches)
-  D. **SILK SCREEN:** Die fast ink is applied to Fabric Style Bags through a screen. The process allows the ink to permeate into the fabric dimples for optimal coverage. Screen charge of \$65.00 applies with each order.
-  E. **FULL COLOUR DIGITAL PRINTING:** Utilizing the latest 4-colour process technology, we now offer full colour digital printed graphics on fabric and nylon bags using a heat press process. This full colour digital printing creates a transfer that allows for vibrant images on both lights and darks. Pricing is the same regardless of the amount of colours used in a design. Have your full colour image applied to your bags for just \$2.45 per bag (minimum 300 bags)

3. Choose the Print Colour

When Foil Printing, select from 41 foil colours in 4 different finishes: Metallic (High Sheen or Matte), flat, gloss or pearlized. For ink printing select from our 9 standard colours for in stock items, or ask about Pantone Matching for Special Order items such as Simply Bags and Fabric Style Bags.

4. Send us your artwork.

If you are a new print customer, send us your artwork by e-mail. Artwork must be vector with fonts outlined or high resolution (300 dpi) actual size jpg if vector can not be located.

If you don't have artwork or your artwork needs adjustments, we have a talented design team who can assist you. Contact one of our sales representatives or email us your ideas today. For pricing, see the artwork charges section.

Acceptable Artwork Formats

- Vector files (preferred): Adobe Illustrator with .ai, .eps, or .pdf file extension. If the logo was ever professionally made, at a marketing agency, print shop or sign maker, they will have the logo on file. Check with the original graphic designer. If vector cannot be provided, ALL raster formats will be subject to additional art charges as in most cases it will have to be converted to a vector to meet our printers requirements.
- Raster files: (ie. PDF, PSD, TIF, or JPEG) Actual size, high resolution (300dpi or more), is required for all full colour reproduction.
- Please include fonts (.ttf) or convert fonts to outlines when sending ANY Illustrator file, saved as AI, EPS or PDF.

The following formats are NOT acceptable

- Publisher (.pub) • CorelDraw (.cdr) • small GIF or BMP internet images • low resolution JPG
- Any Word or spreadsheet documents - '.docx', '.xls', '.wpd', '.od'

If unsure about any format including "what is a vector" please send all inquiries to your inside Customer Service Rep

OTHER PRINTING COSTS

Artwork Charges: As mentioned above, we have a talented creative team that can work with you to design, create, manipulate or re-size your store logo or name. Artwork service is charged at a rate of \$75.00/hour, min. 1/2 hour.

Set-up Charges: Every print job requires a machine to be set-up. A charge will be applied to every order. Foil, Ink, Pad and Digital printing is charged at \$37.00. Silk Screen printing is \$75. Please note: multiple print sizes of the same logo require multiple set-ups.

Plate Charges: Plate charges apply one-time only. Each time you require a 'new' print design (i.e. Logo change, Print Size Adjustment etc.) a new plate must be created. Once the plate is made, we will hold it for you in our warehouse and it will be available for all future printing requirements. Plate charges range in cost from \$80.00 for a Foil Printing plate to \$137.50+ for an Ink Printing Plate. (maximum 25 square inches)

FOIL STAMPING COLOURS

Metallic Options

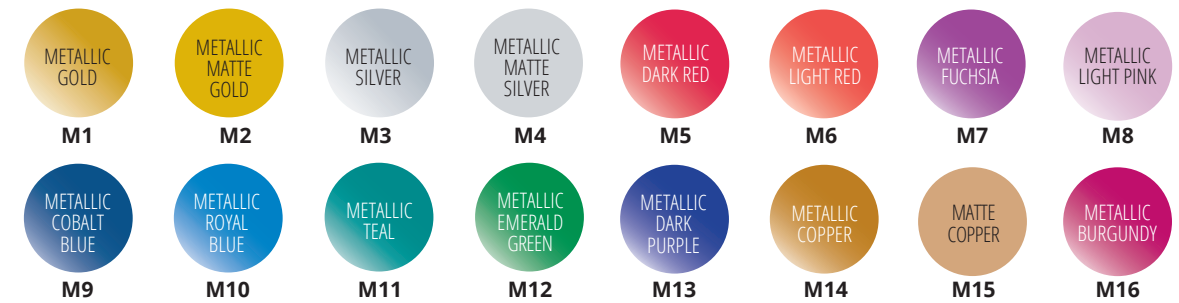

Metallic options feature a high sheen finish unless otherwise indicated as matte finish.

Flat Options



Pearlized Options

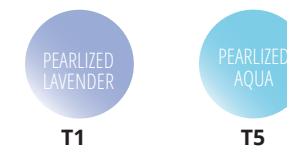

Gloss Options



Satine Foil Colours



INK PRINTING COLOURS

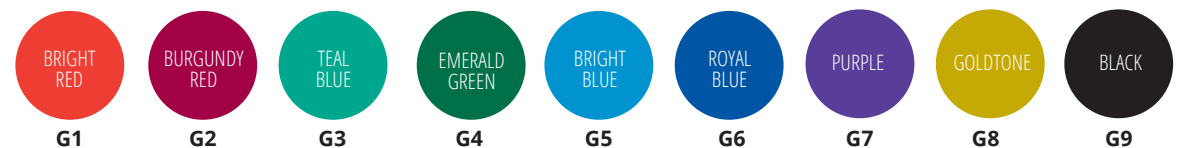

PAD PRINTING COLOURS

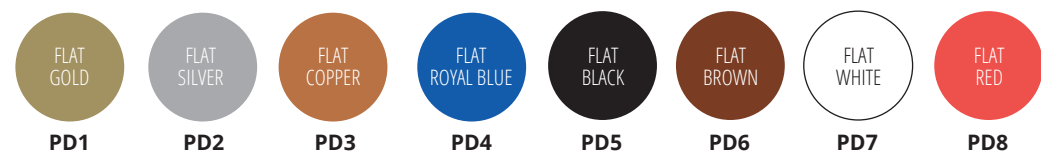

Colours shown are representations only and may not reflect true production colours.



GUNTHERMELE 1857
PACKAGE WITH PURPOSE

PLACE AN ORDER

Call Customer Service: 519.756.4330
Toll Free: 1.888.486.8437
Order on line: gunthermele.com
Direct Fax: 519.756.4335



EASY PAYMENT OPTIONS

- Online at: gunthermele.com and pay with your credit card
- Over the phone, by: Visa or Mastercard
- Via your bank's online bill payment option by selecting "Gunther Mele" as payee
- Contact head office to set up EFT

Sign up for paperless billing. See our website for more information.

Sales Representatives:

British Columbia

JOE BOGDANICH AND
BRENDA TOMASELLA
Cell: 604.561.5444
Email: jbcnwest@gunthermele.com

Alberta

DORIS COOPER AND JOHN COOPER
Tel: 403.931.2261
johndoris@jdcooper.ca

Manitoba / Saskatchewan /NW Ontario

MAURA SHALE
Cell: 204-792-8222
Email: mshale@gunthermele.com

Central Northern Ontario

CHRISTY AIKIN
Cell: 705-794-4585
Email: caikin@gunthermele.com

Toronto

JIM TERESCHUK
Cell: 416.882.3346
Fax: 519.256.1486
Email: jimtereschuk@sympatico.ca

Hamilton / Niagara / Burlington / Oakville

KELLY VANDENBROEK
Cell: 519.670.9574
Email: kvandenbroek@gunthermele.com

Southern Ontario

CINDY MAY
Cell: 416.823.8653
Email: cmay@bell.net
AGOSTINO PORCELLINI
Cell: 416.568.2221
Email: ago@bell.net

Ottawa / Eastern Ontario

Tel: 1.888.486.8437
Fax: 519.756.4335
Email: customerservice@gunthermele.com

Montreal / Gatineau / Greater Montreal Area

MARIE TOUTONGI
Cell: 514.816.7683
Email: mtoutongi.pkg@videotron.ca

Maritimes / Newfoundland & Labrador

MARK AMYOT
Cell: 902.893.1209
Fax: 800.494.5447
Email: forefront@ns.sympatico.ca

TERMS AND CONDITIONS:

- Minimum order \$250.00.
- F.O.B point: Brantford, Ontario Canada.
- Net 30 days O.A.C.
- New account payment terms: Visa or MasterCard 50% deposit with order, balance due upon shipping.
- Defective merchandise will be accepted back for credit only if claimed within 15 days of receipt of shipment. Authorization number must be obtained by contacting our customer service department 1.888.486.8437.

- In-transit damages and shortages must be claimed with the freight carrier at time of delivery.
- All lead times are estimates only (from receipt of approved artwork and credit) and are not guaranteed.
- Plate charges where applicable are:
Foil Print Dies: \$80.00 per size (maximum 30 square inches)
Pad Dies: \$104.50 per size (maximum 3.75 square inches)
Ink Plates \$137.50 (maximum 25 square inches)
- **While we strive for accuracy in our catalogue, actual product may be slightly different than pictured.**
- Prices subject to change without notice.

GUNTHER MELE LTD., 30 Craig Street, Brantford, ON N3R 7J1 Tel: 519.756.4330 Fax: 519.756.4335 Email: packaging@gunthermele.com

GUNTHERMELE.com

06-26-2023