

**JEWELRY PACKAGING GUIDE** – WITH GMP PRICING  
2023 • VOLUME 165





## OUR VISION

“Helping our customers tell their unique brand story while providing a customer experience like no other.”

– Darrell King, President

**Welcome** to our new packaging guide – our 165th version since our founding in 1857. We have some exciting developments in the following pages. Most of the changes we have ushered in this year are centered around a more sustainable approach to our business with an emphasis on the materials we use and the reusability of our products. We have begun to view all of our products through this new lens of eco-minded sustainability. We call this our “**Mission Green**”.

Mission Green drives us to use materials that are either from recycled or sustainable sources. It also focuses us on a vastly overlooked practice in sustainability: reusability.



### RECYCLED

There are two important terms that classify the source of recycled content. These are: post-consumer waste and post-industrial waste. Post-consumer waste (PCW). Wherever possible, we are using paper and now plastics that are derived, at least partially if not fully, from municipal recycling programs and this term post-consumer implies that it has been recovered after consumer use. Post-industrial waste (PIW). Another key source of recycled material. In this instance, scrap material is diverted from the landfill and recycled into new material to be used in production. Product Examples include: our brand new, Canadian made paper twist shoppers made from paper that is derived from 96% post-consumer waste. Our new “resuede” is a luxurious recycled material that feels like plush suede but is produced using recycled materials to create a luxury look and feel. We feature our resuede material in our Drawer Series box (page 39) and our Eco Series of hinged boxes (page 27)

### SUSTAINABLE

FSC – Forestry Stewardship Council. In short, this governing body oversees wood and pulp (paper) products derived from responsibly managed forests. This global governing body is an intricate certification process that verifies paper and its sources. In the instances where paper needs to come from new pulp source, we are choosing to use papers that carry the widely recognized FSC designation.

### REUSABLE

Jewelry packaging has an inherent keepsake quality. Most people will collect jewelry boxes for storage and sentimental value. We have also been studying consumer behavior and there is demand for an after use of jewelry packaging. Our active lifestyles and thirst for travel dictates the need to store and protect jewelry when it is not being worn. With that, we have introduced our new Nano™ collection of luxurious and practical travel pouches that not only present the jewelry exquisitely but also doubles as ongoing storage and protection for our society who is always on the go.

In nearly every category we have exciting new products that meet our Mission Green criteria. These are just the first steps of our journey toward more sustainable and eco-conscious packaging solutions and we hope you’ll join us on this important journey.

# TRENDING

# ECO CHIC



## Signature Velvet Series

Plush black velvet hinged boxes accented with suede pads and bengaline trim detail

See page 17



## EcoBox Hinged

50% recycled material plastic shell  
resuede interior

See page 27



## Drawer Box

100% recyclable paper board with  
resuede pads and pulls

See page 39



## Deco Box

Recycled paperboard

See page 41



## CYOL 6 Easy Pieces Hinged Packaging

with coordinating eurototes

See page 28



## All Paper Shopper

100% recyclable / 40% post  
consumer waste

See page 79



## RPET REUSABLES

Mission Green - sustainable 80% woven  
recycled RPET laminated tote

See page 91



## Paper Twist

Mission Green - 100% recyclable

See page 85

# CYOL

Made to Order Jewelry Display



# IN STOCK

Jewelry Display



Platforms and Risers

Ring Showcase

Pendant & Earring Stands

Neck Forms & Bracelet Stands

Trays, Counter Pads,  
Chain Ramps

Open Stock and Prepacks  
Available

**Save 25% when you buy  
\$500 or more!**

Tell your brand story  
Create your unique identity

Elevate the  
shopping experience

Drive more sales

**Complimentary  
Display Design**

Financing Programs Available

\*Complete set of renderings available with payment of deposit.  
Deposits will be deducted from invoice at time of billing.



# PROPOSAL

Ring Presentation



## Ring Stash

The solution to bulky engagement ring boxes.

- Discreet compact size
- Flexible ring clip firmly holds the ring in place
- Magnetic closure
- Light weight and durable
- Black sleeve packer
- Printing options available
- U.S. Patent #9375066

68021015L  
2.32" x 2.44" x .55  
**\$22.36/ea.** 12/case

Minimum order 12.  
Estimated lead time: 2 - 3 weeks for printed items from approved art.

You've sold the perfect ring.  
They've planned the perfect moment.  
Help them keep it a secret.

 **FOIL / PAD PRINT**  
F: inside liner / PP: top lid only  
12+ 35¢ each  
144+ 32¢ each  
504+ 26¢ each

# PROPOSAL

Ring Presentation



## Proposal Ring Hinged Box

- Single ring box with matching ribbon pull accent and ring clip
- Brushed ivory linea interior
- White sleeve packer
- Minimum case pack 12

36220 \_\_\_\_\_  
2.36" x 2.36" x .94"  
**\$3.65 each** (12+)  
**\$3.17 each** (144+)

Estimated lead time: 2 - 3 weeks for printed items from approved art.

 **FOIL / PAD PRINT**  
F: inside top liner  
PP: inside top liner and top lid  
12+ 35¢ each  
144+ 32¢ each  
504+ 26¢ each

873B - Bronze



## Sweetheart Box

See page 31



## Nano Clutch

See page 38



# TABLE OF CONTENTS

## Jewelry Packaging

Proposal Ring Specialty Boxes .....	8 - 9	Nest Boxes .....	46 - 48
Hinged Packaging .....	12 - 39	Jewelry Folders .....	38 and 49
<b>New</b> Signature Series .....	17	Create Your Own Look Details .....	50 - 51
<b>ECO</b> EcoBox .....	27	Gift Card and Certificate Boxes .....	52 - 53
Vantage .....	29	Pouches .....	54 - 55
<b>ECO</b> Drawer Box .....	39	<b>New</b> Jewelry Cloths and Cleaners .....	56 - 57
Paperboard Jewelry Packaging .....	40 - 45	Repair Envelopes and Tags .....	58

## Jewelry Display

Create Your Own Look Element and Showcase Platform Styles .....	60 - 61	<b>New</b> In Stock Jewellery Displays .....	64 - 72
Create Your Own Look Fabrics and Color Options .....	62 - 63		

## Jewelry Storage by Mele & Co.

Stowaway Line and Highlights .....	74
------------------------------------	----

## Bags

Vantage, Eclipse and Geo Eurototes .....	76	<b>New</b> <b>ECO</b> Food Service Kraft Bags .....	87
Rope Handle Paper Totes .....	77	Custom Printed Poly Shopping Bags .....	88
Grosgrain Handle Eurototes .....	78	Frosted Poly .....	89
<b>ECO</b> All Paper Eurototes .....	79	Poly Merchandise Bags .....	89
CYOL Rope Handle .....	80	Custom Full Color Reusable .....	90
5th Avenue Eurototes .....	81	<b>ECO</b> RPET Reusable Bags - Recycled Bottles ..	91
Manhattan Eurototes .....	82	<b>New</b> Upcycle and Toronto Laminated Totes ...	92
<b>New</b> <b>ECO</b> Special Order Paper Shoppers .....	83	In Stock Reusable Fabric Shoppers .....	93
<b>ECO</b> CYOL Simply Paper Shoppers .....	84	Garment Covers .....	94
<b>ECO</b> In Stock Paper Twist Handle & Damask ..	85		
<b>ECO</b> In Stock Die Cut Handle & Merchandise ..	86		

## Gift Boxes and E-Commerce

Malibu Magnetic Gift Box .....	96	CYOL E-Com Boxes and Mailers .....	100
Tuckit® Boxes .....	96	<b>New</b> In Stock E-Com Boxes for Gift & Apparel ..	101
White Folding Gift Boxes .....	97	In Stock E-Com Boxes for Jewelry .....	101
Apparel Boxes .....	97	In Stock and S/O E-Com Mailers .....	102

## Finishing Touches

<b>New</b> Inspirations Gift Wrap .....	104 - 105	Printed and Unprinted Ribbon ....	114 - 117
Jewelers Rolls .....	109	In Stock Seals - Foil Print .....	118 - 119
Special Order Gift wrap .....	106 - 109	Custom Seals - Full Color .....	120 - 121
Tissue Paper .....	110 - 111	Print Information & Print Colors ..	122 - 123
Bows, Cellophane & Dispensers ...	112 - 113		

# JEWELRY PACKAGING



# CREATE YOUR OWN LOOK

JEWELRY PACKAGING



## WOOD SERIES

The possibilities are endless when you choose wooden materials. Endless and timeless, in terms of size, shape, finish and color. High-end style, this collection features our Monterey series shape with a high gloss white finish, black "reveal" edge and black linea interior. Add a matching custom tote bag to complete the look.

# IN STOCK

## Hinged Boxes

JEWELRY PACKAGING



**COORDINATING  
EUROTOTES**  
See pages 77

Available Colors



Outer Box  
**150MC - Black Gloss**



Outer Box  
**320M - Mahogany**



**150MCB -  
OPTIONAL  
BLACK INTERIOR  
RING BOX ONLY**

## Monterey II

Wood series with modern lines and a gloss finish.

- Soft white leatherette interior
- Packaged in a 2-piece white traditional outer box

CODE	DESCRIPTION	SIZE (inches)	PRICE/EACH	
			12+	144+
36821	Ring (R1)	2.375 x 2.375 x 2	\$8.84	\$7.66
36822	Earring (E1)	2.375 x 2.375 x 2	\$8.84	\$7.66
36843	Utility T-pad (ET14)	4 x 4 x 2	\$16.13	\$13.64
36850	Watch (PL1)	4.375 x 4.375 x 2.75	\$18.13	\$16.25
36893	Bracelet (BL1)	9.5 x 2.375 x 1.5	\$17.71	\$15.89
36813	Necklace (N2)	7.5 x 7.5 x 2	\$30.03	\$26.95

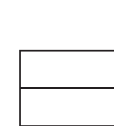

R1  
SLOTTED RING PAD

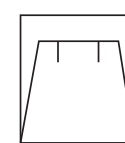

E1  
DIE CUT EARRING/PENDANT PAD

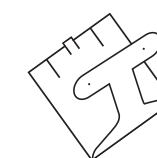

ET14  
T FLAP PENDANT/EARRING PAD

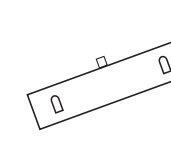

BL1R  
BRACELET PAD (metal clips)  
REMOVABLE

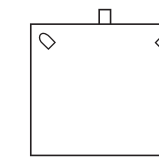

N1  
NECKLACE PAD REMOVABLE

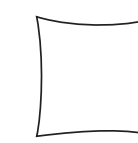

PL1  
WATCH PILLOW



**FOIL / PAD PRINT**  
F: inside liner and packer lid / PP: all 3 locations  
12+ 35¢ each  
144+ 32¢ each  
504+ 26¢ each

Minimum 12 per style.  
Please allow 2 - 3 weeks for printed items from approved art.

All print orders subject to set-up charges. Applicable artwork, and plate charges may apply. See page 122.

# CREATE YOUR OWN LOOK

JEWELRY PACKAGING



## WHISPER SERIES

Our modern luxury box is shown here in a stylish textured gold paper called: Shuttle. Matching interior and pads create a seamless look.

# IN STOCK

## Hinged Boxes



**COORDINATING  
EUROTOTE**  
See page 78

Available Colors



Outer Box

**559W - Carbon Black**



Outer Box

**009W - Moon Glow**



Outer Box

**289W - Palladium**

## Whisper

Elegant curves and round corners.

- Monochromatic metallic pinsketch linea fabric
- Packaged in a coordinating 2-piece outer box

CODE	DESCRIPTION	SIZE (inches)	PRICE/EACH	
			12+	144+
36821	Ring (R1)	2.375 x 2.375 x 2.125	\$7.85	\$6.80
36822	Earring (E1)	2.375 x 2.375 x 2.125	\$7.85	\$6.80
36823	Large Ring (R1)	3.25 x 3.25 x 2.25	\$11.44	\$9.95
36883	Utility T-pad (ET14)	3.25 x 3.25 x 2.25	\$10.58	\$9.15
36850	Watch (PL1)	4 x 4 x 2.75	\$14.30	\$12.44
36893	Bracelet (BL1)	9.25 x 2.5 x 1.75	\$14.10	\$12.26
36873	Necklace (N2)	6.5 x 8 x 1.75	\$22.05	\$18.11

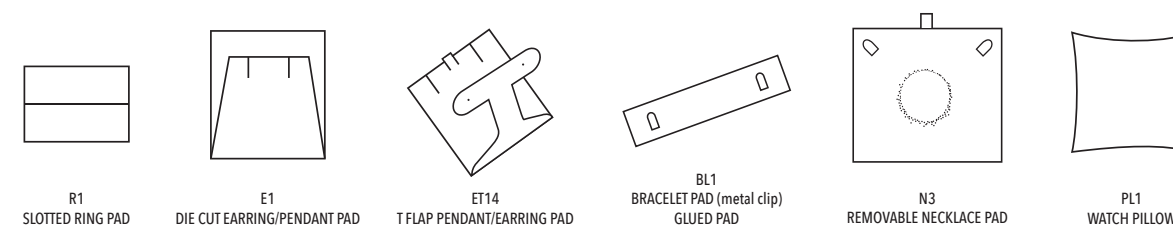

### FOIL / PAD PRINT

F: inside liner and packer lid / PP: all 3 locations  
 12+ 35¢ each  
 144+ 32¢ each  
 504+ 26¢ each

Minimum 12 per style.  
 Please allow 2 - 3 weeks for printed items from approved art.

All print orders subject to set-up charges. Applicable artwork, and plate charges may apply. See page 122.

# CREATE YOUR OWN LOOK

JEWELRY PACKAGING

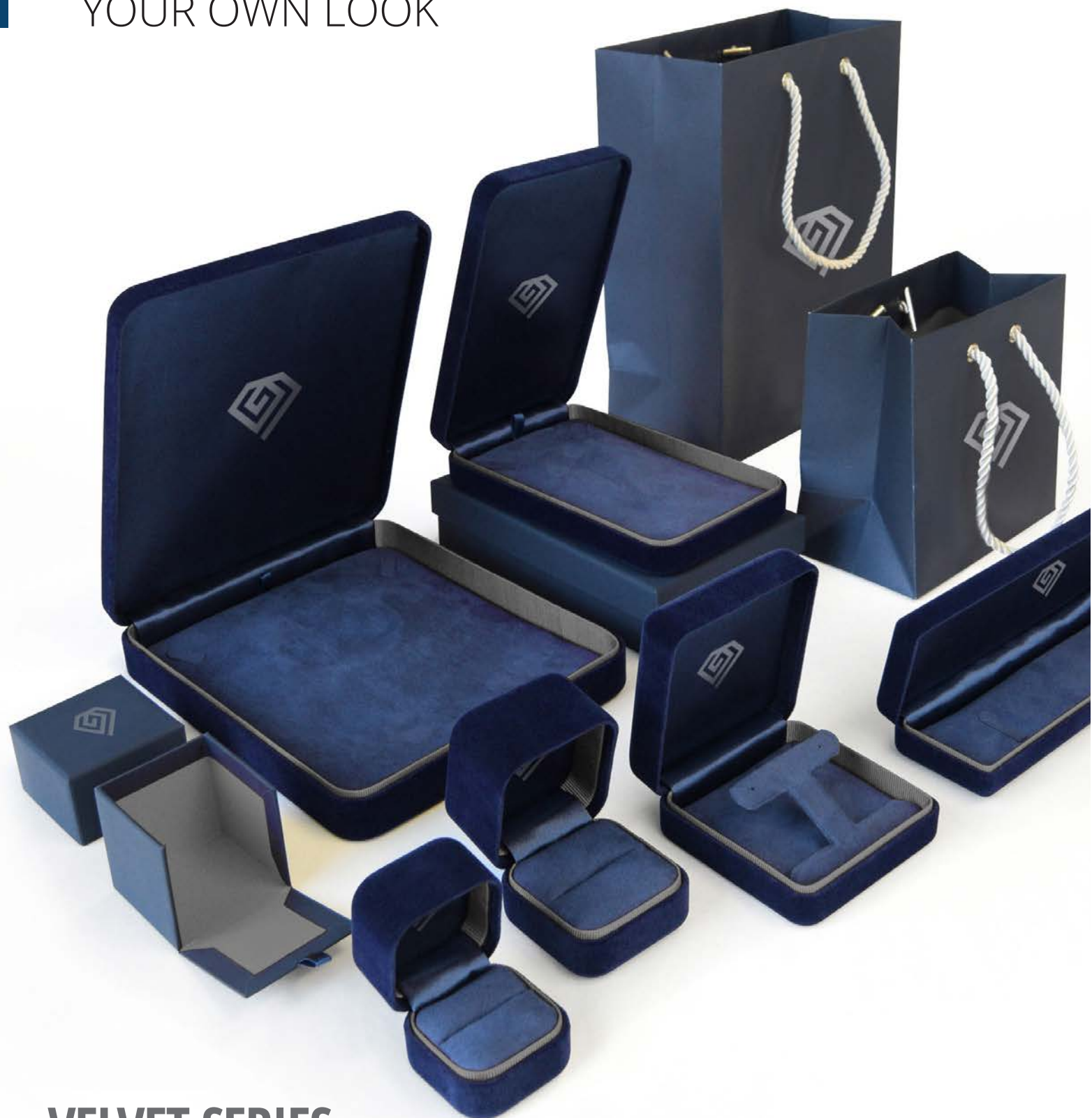

## VELVET SERIES

Plush velvet hinged boxes accented with suede pads and bengaline trim detail.

# IN STOCK

## Hinged Boxes

JEWELRY PACKAGING



COORDINATING  
EUROTOTE  
See page 78



Outer Box

## Signature Series

This modernized classic is a must have.

- Plush black velvet hinged boxes accented with suede pads and bengaline trim detail
- Packaged in a coordinating 2-piece outer box

CODE	DESCRIPTION	SIZE (inches)	PRICE/EACH	
			12+	144+
36521151	Ring (R1)	1.96 x 1.96 x 1.96	\$8.40	\$7.39
36522151	Pendant/Earring (E1)	2.36 x 2.36 x 2.28	\$10.47	\$9.22
36583151	Utility (PL1 or T3)	3.93 x 3.93 x 2.36	\$11.46	\$10.09
69550151	Pillow (PL1)	fits utility box	\$2.59	\$2.28
69583151	Triple Flip Pad (T3)	fits utility box	\$2.59	\$2.28
36573151	Necklace (N3)	7 x 7 x 1.77	\$18.52	\$16.30

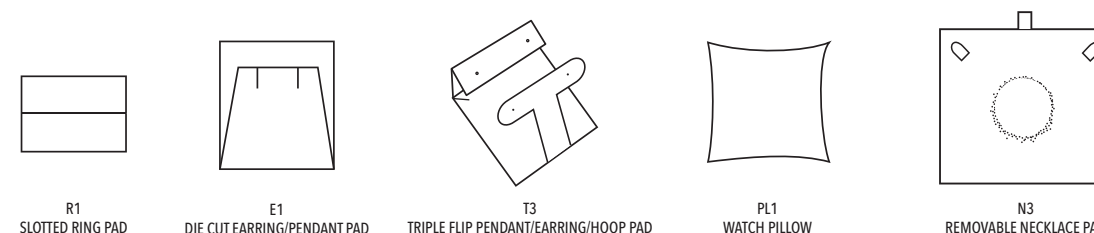

R1 SLOTTED RING PAD    E1 DIE CUT EARRING/PENDANT PAD    T3 TRIPLE FLIP PENDANT/EARRING/HOOP PAD    PL1 WATCH PILLOW    N3 REMOVABLE NECKLACE PAD



**FOIL / PAD PRINT**  
F / PP: inside liner and packer lid  
12+ 35¢ each  
144+ 32¢ each  
504+ 26¢ each

Minimum 12 per style.  
Please allow 2 - 3 weeks for printed items from approved art.

All print orders subject to set-up charges. Applicable artwork, and plate charges may apply. See page 122.

# CREATE YOUR OWN LOOK

JEWELRY PACKAGING



## ECLIPSE SERIES

This eclipse collection features an elegant champagne custom embossed covering with an ivory shimmer interior and gold printed logo on the top liner. The custom rope handle tote completes this beautiful collection.

# IN STOCK

## Hinged Boxes

JEWELRY PACKAGING



**COORDINATING  
EUROTOTE**  
See page 76

Available Colors



Outer Box  
813 - Linea Blue Celestial



Outer Box  
663 - Linea Aubergine



Outer Box  
423 - Brown



50% Recycled Shell

## Eclipse

Classic square corners with a distinctive crescent style front.

- Linea Aubergine and Linea Blue Celestial coverings with Ivory Shimmer satin top liners and pads. Packaged in coordinating full-depth 2-piece outer box
- Rich Brown leatherette covering with Champagne satin top liners and sueded pads. Packaged in white full-depth 2-piece outer box

CODE	DESCRIPTION	SIZE (inches)	AUBERGINE AND BLUE PRICE/EACH		BROWN PRICE/EACH	
			12+	144+	12+	144+
36821 ___	Ring (R1)	2.5 x 2.5 x 1.75	\$7.14	\$6.43	\$5.09	\$4.61
36822 ___	Earring/Pendant (E1)	2.5 x 2.5 x 1.75	\$7.14	\$6.43	\$5.09	\$4.61
36883 ___	Utility T-pad (ET14)	3.75 x 4 x 1.75	\$12.32	\$11.11	\$8.93	\$8.02
36893 ___	Bracelet (BL1)	9.25 x 2.5 x 1.75	\$15.92	\$14.33	\$9.83	\$8.864
36873 ___	Necklace (N2)	6.5 x 8 x 1.75	\$25.78	\$23.22	\$20.07	\$18.13
36850 ___	Watch (PL1)	3.75 x 4.25 x 3	\$17.18	\$15.44	\$11.44	\$10.31

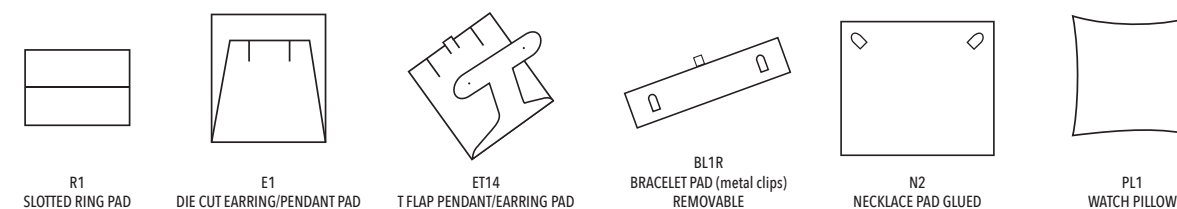

**FOIL / PAD PRINT**  
F: inside liner and packer lid / PP: all 3 locations  
12+ 35¢ each  
144+ 32¢ each  
504+ 26¢ each

Minimum 12 per style.  
Please allow 2 - 3 weeks for printed items from approved art.

All print orders subject to set-up charges. Applicable artwork, and plate charges may apply. See page 122.

# IN STOCK

## Hinged Boxes

JEWELRY PACKAGING



COORDINATING  
EUROTOTE  
See pages 77



Available Colors



114 - Blue

674 - Green

### Estate

Contemporary style with a touch of tradition.

- White velvet pads and satin top liners
- Packaged in a coordinating 2-piece outer box

CODE	DESCRIPTION	SIZE (inches)	PRICE/EACH	
			12+	144+
36021	Ring (R1)	2 x 2.25 x 1.875	\$4.96	\$4.67
36022	Earring (E1)	2 x 2.125 x 1.625	\$4.67	\$4.96
36084	Utility T-pad (ET14)	3.5 x 3.5 x 1.5	\$5.89	\$5.35
36093	Bracelet (BL1)	8.5 x 2.125 x 1	\$9.51	\$8.864
36073	Necklace (N2)	7.125 x 4.375 x 1.25	\$11.42	\$10.47



#### FOIL / PAD PRINT

F: inside liner and packer lid / PP: all 3 locations  
 12+ 35¢ each  
 144+ 32¢ each  
 504+ 26¢ each

Minimum 12 per style.  
 Please allow 2 - 3 weeks for printed items from approved art.



# IN STOCK

## Hinged Boxes

JEWELRY PACKAGING



COORDINATING  
EUROTOTE  
See page 81



Available Colors



114 - Blue

674 - Green

OPTIONAL  
WHITE INTERIOR  
AVAILABLE  
153 - White on Black

OPTIONAL  
BLACK INTERIOR  
AVAILABLE  
153B - Black on Black



Outer Box

### Roma

Distinctive round corner styling with sculpted sides.

- Lizard style embossed covering with leatherette interior
- Packaged in a 2-piece coordinating outer box with ¼ depth lids

CODE	DESCRIPTION	SIZE (inches)	PRICE/EACH	
			12+	144+
36421	Ring (R1)	2.25 x 2.25 x 1.75	\$5.22	\$4.71
36422	Earring (E1)	2.25 x 2.25 x 1.75	\$5.22	\$4.71
36484	Utility T-pad (ET14)	3.75 x 3.75 x 2	\$7.88	\$6.75
36493	Bracelet (BL1)	9.375 x 2.25 x 1.5	\$10.83	\$9.74
36477	Necklace (N3)	7.5 x 7.5 x 2.125	\$18.73	\$16.86

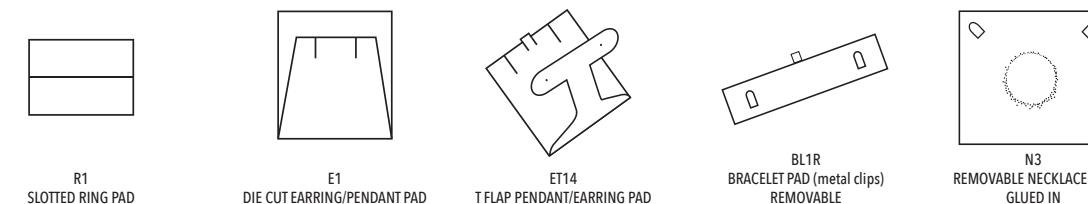

#### FOIL / PAD PRINT

F: inside liner and packer lid / PP: all 3 locations  
 12+ 35¢ each  
 144+ 32¢ each  
 504+ 26¢ each

Minimum 12 per style.  
 Please allow 2 - 3 weeks for printed items from approved art.



50% Recycled Shell

All print orders subject to set-up charges. Applicable artwork, and plate charges may apply. See page 122.

All print orders subject to set-up charges. Applicable artwork, and plate charges may apply. See page 122.

# CREATE YOUR OWN LOOK

JEWELRY PACKAGING



## GEO SERIES

A series completely unique with added top stitching to the covering and upgrading the fabric to a luxurious grey leatherette. This Geo collection features a debossed logo on the top of the lid. Matching dark interior pads create a seamless look to showcase fine pieces. Packaged in two-tone 3/4 depth outer box with a silver embossed print. This collection is completed with coordinating custom rope handle totes.



### E-Commerce Jewelry Boxes

Deliver the 'in-store' experience to your customer's door  
See page 101 for more information

# IN STOCK

## Hinged Boxes

Available Colors



873B - Bronze



563P - Purple



153B - Black



083 - Luxe Silver\*



50% Recycled Shell and FSC Paper Used



COORDINATING EURO TOTE  
See page 76

415B - Black Packer with Ivory Pouch  
456P - Purple Packer with Ivory Pouch  
427T - Bronze Packer with Ivory Pouch

## Geo

Modern texture in a choice of 4 color options.

- Ivory brushed leatherette pads and satin top liners
- Packaged in a coordinating 3/4 depth 2-piece outer box

CODE	DESCRIPTION	SIZE (inches)	PRICE/EACH	
			12+	144+
36221	Ring/Earring (R1/E8)	2.375 x 2.375 x 2.375	\$4.41	\$3.95
36283	T-pad Pendant (ET14)	3.5 x 4.5 x 1.5	\$5.83	\$5.02
36293	Bracelet (BL1)	9 x 2.375 x 1.5	\$7.71	\$6.93
36273	Necklace (N2)	7 x 7 x 1.5	\$13.11	\$11.81
36220	Proposal Box* (R2)	2.36 x 2.36 x .94	\$3.65	\$3.17
36224	Lighted Ring/Earring* (R1)	2.36 x 2.36 x 2.36	\$12.12	\$11.21
09030	Pouch with Box*	3 x 4	\$2.19	\$1.84
69221100G	Earring Pad to fit Ring/Earring box (E8)		\$0.84	

\* not available in Luxe Silver

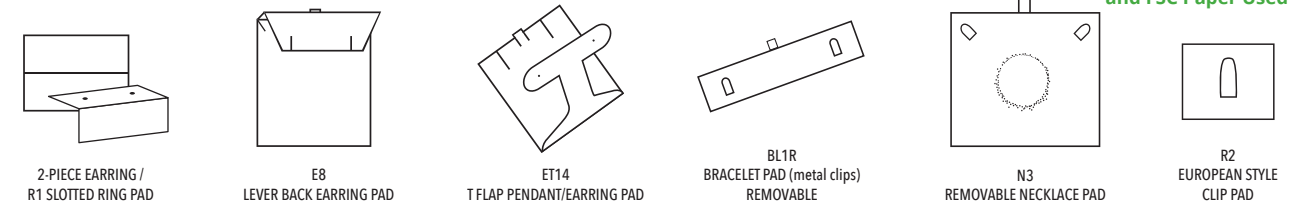

**FOIL / PAD PRINT**  
F: inside liner and packer lid / PP: all 3 locations  
12+ 35¢ each  
144+ 32¢ each  
504+ 26¢ each

Minimum 12 per style.  
Please allow 2 - 3 weeks for printed items from approved art.

All print orders subject to set-up charges. Applicable artwork, and plate charges may apply. See page 122.

# SPECIAL ORDER

## Geo Series Boxes and Bags

JEWELRY PACKAGING



Available in 16 colors  
in a selection of 4 luxurious  
textured papers.



Shown in Celestial Blue

Shown in Moss

Shown in Brick

Contact your representative for assistance  
selecting your texture and color.

# SPECIAL ORDER

## Geo Series Boxes and Bags

JEWELRY PACKAGING

### 16 Color Options Available



### 4 Texture Paper Options Available



### Geo Hinged Packaging

- Ivory brushed leatherette pads and satin top liners
- Packaged in a coordinating ¾ depth 2-piece outer box

DESCRIPTION	SIZE (inches)	PRICE/EACH
Ring/Earring	2.375 x 2.375 x 2.375	\$6.62
T-pad Pendant	3.5 x 4.5 x 1.5	\$7.72
Bracelet	9 x 2.375 x 1.5	\$9.04
Necklace	7 x 7 x 1.5	\$13.63
Proposal Box	2.36 x 2.36 x .94	\$4.88

**FOIL PRINT** - INCLUDED IN PRICE  
Inside Top Liner  
Packer Lid

Boxes: Minimum 1500 assorted! (min 100 per box)  
Bags: Minimum 1000 each size with purchase of 1500 boxes.  
Estimated lead time: 12 - 14 weeks for printed items from approved art.

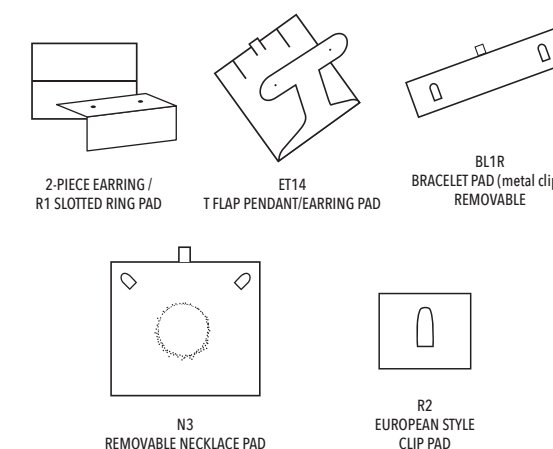

### Geo Eurototes

- 110 gsm uncoated paper with 8mm rope handles
- Foil printed two sides

SIZE (inches)	PRICE/EACH
6 x 3.5 x 6 x 3.5	\$1.70
9 x 3.5 x 7 x 3.5	\$1.94
10.5 x 5 x 8.5 x 5	\$2.59

**FOIL PRINT**  
PRINTING INCLUDED IN PRICE

Bags Only: Minimum 3000 each size.  
Estimated lead time: 12 - 14 weeks for printed items from approved art.

## Our Top Selling Collection Just Got Even Better!

Printing included for  
any of the items in this program.

Choice of Matte or Metallic Foil Print:  
Gold, Silver, Copper or Black.

All print orders subject to set-up charges. Applicable artwork, and plate charges may apply. See page 122.

# IN STOCK

## Hinged Boxes

# IN STOCK

## Hinged Boxes

JEWELRY PACKAGING

JEWELRY PACKAGING



**COORDINATING EUROTOTE**  
See page 77

**COORDINATING ALL PAPER EUROTOTE**  
See page 79

### Palladium Inlay

Stylish contemporary series.

- Palladium grey brushed exterior
- Cream pads and top liner with matching exterior edge
- Packaged in a coordinating 2-piece outer box

CODE	DESCRIPTION	SIZE (inches)	PRICE/EACH	
			12+	144+
36221283P	Ring (R1)	2.25 x 2 x 1.75	\$6.03	\$4.95
36222283P	Earring (E1)	2.25 x 2 x 1.75	\$6.03	\$4.95
36283283P	Utility T-pad (ET14)	3.18 x 4.17 x 1.41	\$8.50	\$7.22
36293283P	Bracelet (BL1)	8.6 x 2.16 x 1	\$9.77	\$8.18
36273283P	Necklace (N2)	6.25 x 4.4 x 1.41	\$11.67	\$9.83



**FOIL / PAD PRINT**  
F: inside liner and packer lid / PP: all 3 locations  
12+ 35¢ each  
144+ 32¢ each  
504+ 26¢ each

Minimum 12 per style.  
Please allow 2 - 3 weeks for printed items from approved art.



### EcoBox

Modern look inside and out.

- Gunther Mele Mission Green product
- Made with recycled paper exterior
- Made with 50% recycled material plastic shell
- Resuede interior material (49% recycled)

CODE	DESCRIPTION	SIZE (inches)	PRICE/EACH	
			12+	144+
36121000	Ring/Earring (R1)	2 x 2 x 1.5	\$4.16	\$3.54
36163000	T-Pad Pendant/Earring (ET14)	3.75 x 3.75 x 1.33	\$6.69	\$5.69
36193000	Bracelet (BL1)	8.5 x 2 x .91	\$5.89	\$5.01
36173000	Necklace (N3)	7 x 5 x 1.10	\$10.69	\$9.09

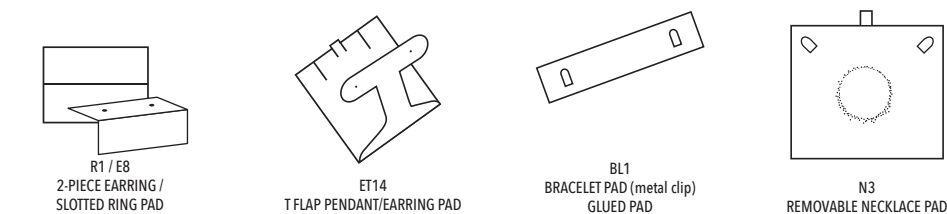

**FOIL / PAD PRINT**  
F: inside liner / PP: top lid  
12+ 35¢ each  
144+ 32¢ each  
504+ 26¢ each

Minimum 12 per style.  
Please allow 2 - 3 weeks for printed items from approved art.



All print orders subject to set-up charges. Applicable artwork, and plate charges may apply. See page 122.

All print orders subject to set-up charges. Applicable artwork, and plate charges may apply. See page 122.

# CREATE YOUR OWN LOOK

# IN STOCK Hinged Boxes

JEWELRY PACKAGING

JEWELRY PACKAGING



**COORDINATING EUROTOTE**  
See below and on page 76

Ring box shown with optional earring pad in place

Available Colors

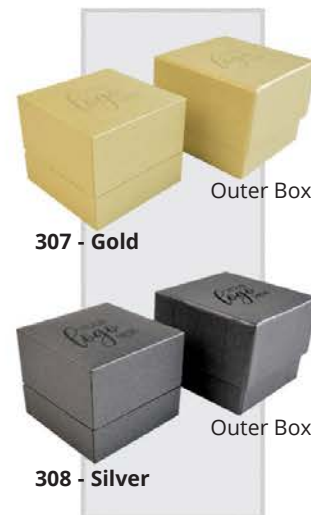

Outer Box

307 - Gold

Outer Box

308 - Silver

## Vantage II

Elegant gold and silver in a linen embossed pattern.

- White satin top liners and leatherette bottom pads
- Packaged in a coordinating 3/4 depth lid 2-piece outer box



CODE	DESCRIPTION	SIZE (inches)	PRICE/EACH	
			12+	144+
36221 ___	Ring/Earring (R1/E8)	2 x 2 x 1.625	\$4.31	\$3.65
36232 ___	T-Pad Pendant (ET14)	2.64 x 2.72 x 2.165	\$5.17	\$4.41
36284 ___	Utility T-pad (ET14)	3.5 x 3.5 x 2	\$6.28	\$5.34
36293 ___	Bracelet (BL1)	8.625 x 2.125 x 1.25	\$8.56	\$7.11
36273 ___	Necklace (N2)	6.25 x 4.5 x 1.5	\$10.75	\$9.03

Minimum 12 per style. Please allow 2 - 3 weeks for printed items from approved art.

**FOIL / PAD PRINT**  
F: inside liner and packer lid / PP: all 3 locations  
12+ 35¢ each  
144+ 32¢ each  
504+ 26¢ each

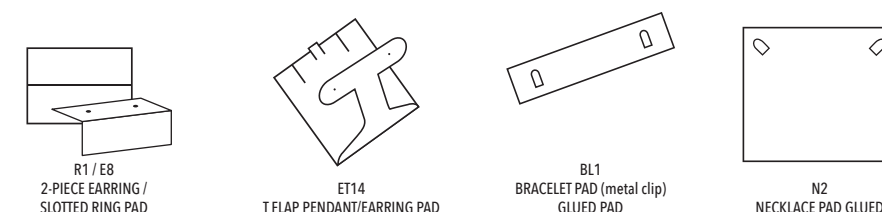

## VANTAGE SERIES

6 pieces - 2 boxes + 4 inserts + 9 presentations. A streamlined and customized assortment.

## Coordinating Eurototes

- 150 gsm uncoated paper with 8mm paper cord handles
- Minimum 100 per color

CODE	SIZE (inches)	PRICE/EACH		
		100+	500+	1000+
A 230606 ___	6 x 3.5 x 6 x 3.5	\$1.00	\$0.92	\$0.79
B 231008 ___	10.5 x 5 x 8.5 x 5	\$1.27	\$1.14	\$0.98



Estimated lead time: 2 - 3 weeks for printed items from approved art.

**FOIL PRINT**  
100+ 35¢ each  
1000+ 32¢ each  
2500+ 26¢ each

All print orders subject to set-up charges. Applicable artwork, and plate charges may apply. See page 122.

# IN STOCK

## Hinged Boxes

JEWELRY PACKAGING



**COORDINATING EUROTOTE**  
See page 77



### Glitter

Sparkle and shine with this great glittering series.

- White faux-suede pads and satin top liners
- Packaged in a black sleeve

CODE	DESCRIPTION	SIZE (inches)	PRICE/EACH	
			12+	144+
36221183	Ring (R1)	1.75 x 2 x 1.5	\$2.30	\$1.92
36222183	Earring (E1)	1.75 x 2 x 1.5	\$2.30	\$1.92
36284183	Utility T-pad (ET14)	3.5 x 3.5 x 1.25	\$3.85	\$3.40
36293183	Bracelet (BL1)	8.75 x 2.125 x 1	\$4.97	\$4.31
36273183	Necklace (N2)	6.25 x 4.25 x 1.25	\$6.32	\$5.47



**FOIL / PAD PRINT**  
F: inside liner / PP: inside top liner and box lid  
12+ 35¢ each  
144+ 32¢ each  
504+ 26¢ each

Minimum 12 per style.  
Please allow 2 - 3 weeks for printed items from approved art.



# IN STOCK

## Hinged Box

JEWELRY PACKAGING



Available Colors



### Sweetheart

Show the love with this sweet new velvet vintage inspired ring box.

- Velvet with satin top liner to put a small logo or icon
- Available in soft blush and three jewel tone colors
- Packaged in a 2-piece white outer box

CODE	DESCRIPTION	SIZE (inches)	PRICE/EACH	
			12+	144+
36121 _ _ _	Ring (R1)	1.5 x 1.5 x 1.5	\$5.75	\$3.70

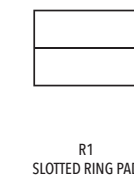

**FOIL / PAD PRINT**  
F: inside liner and packer lid / PP: inside top liner and packer lid  
12+ 35¢ each  
144+ 32¢ each  
504+ 26¢ each

Minimum 12 per style.  
Please allow 2 - 3 weeks for printed items from approved art.



# IN STOCK

## Hinged Boxes

JEWELRY PACKAGING



**COORDINATING EUROTOTE**  
See page 77



### Jewelers Velvet

Lasting traditions.

- Satin top liners
- Packaged in a white 2-piece outer box

CODE	DESCRIPTION	SIZE (inches)	PRICE/EACH	
			12+	144+
36121 ___	Ring (R1)	2 x 2.125 x 1.5	\$2.55	\$2.33
36141 ___	Large Ring (R2)	2.5 x 2 x 1.5	\$3.26	\$2.93
36122 ___	Earring (E2)	2 x 2.125 x 1.5	\$2.55	\$2.33
36132 ___	Utility T-pad (ET14)	2.5 x 2.5 x 1.25	\$3.26	\$2.93
36163 ___	Pendant (E1)	2.25 x 3 x 1.125	\$3.26	\$2.93
36183 ___	Utility (EP4)	3.5 x 3.375 x 1.5	\$5.17	\$4.64
36193 ___	Bracelet (BL1)	8 x 2 x 1.25	\$5.33	\$4.81
36173 ___	Necklace (N2)	7 x 4.25 x 1.5	\$8.93	\$8.06

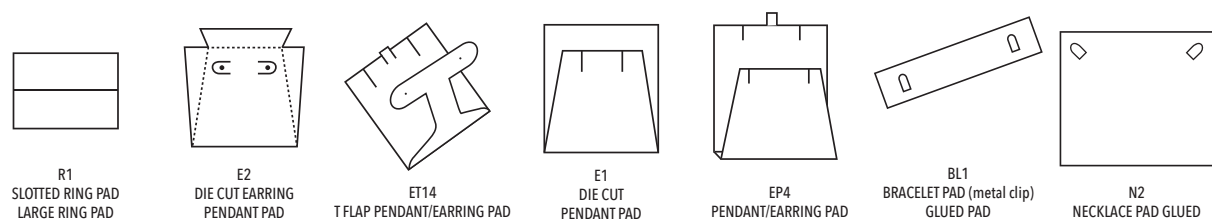

**FOIL / PAD PRINT**

F: inside liner and packer lid / PP: inside top liner and packer lid  
 12+ 35¢ each  
 144+ 32¢ each  
 504+ 26¢ each

Minimum 12 per style.  
 Please allow 2 - 3 weeks for printed items from approved art.



# IN STOCK

## Hinged Boxes

JEWELRY PACKAGING



**COORDINATING EUROTOTE**  
See page 77

### Econoline

Lasting traditions in blue.

- Blue velour exterior
- Matching interior with white satin
- Arrives in protective white sleeve
- Optional white gloss packer

**ADDITIONAL CHARGE FOR OPTIONAL 2-PIECE OUTER BOX**



CODE	DESCRIPTION	SIZE (inches)	PRICE /EACH		2-PIECE CONTAINER PRICE /EACH	
			12+	144+	31	003
36121119	Ring (R1)	1.875 x 2.125 x 1.375	\$1.92	\$1.71	121	\$0.74
36141119	Large Ring (R1)	2.375 x 2 x 1.5	\$2.09	\$1.88	141	\$0.78
36122119	Earring (E2)	1.875 x 2.125 x 1.375	\$1.92	\$1.71	121	\$0.74
36163119	Pendant (E1)	2.25 x 3 x 1.125	\$2.62	\$2.34	163	\$0.81
36132119	T-pad Pendant (ET14)	2.5 x 2.5 x 1.25	\$2.62	\$2.34	132	\$0.81
36193119	Bracelet (BL1)	8 x 2.125 x 1	\$4.02	\$3.61	193	\$1.02
36173119	Necklace (N2)	7 x 4.25 x 1.375	\$6.83	\$6.17	173	\$1.48
36183119	Utility (EP4)	3.875 x 3.25 x 1.375	\$4.02	\$3.61	183	\$1.11
69221000B	Bead Pad for earring box		\$0.68	\$0.56	—	—



**Bead Pad**

- pad fits stud earring box
- ribbon threads through bead
- ribbon wraps to back and is held by clip

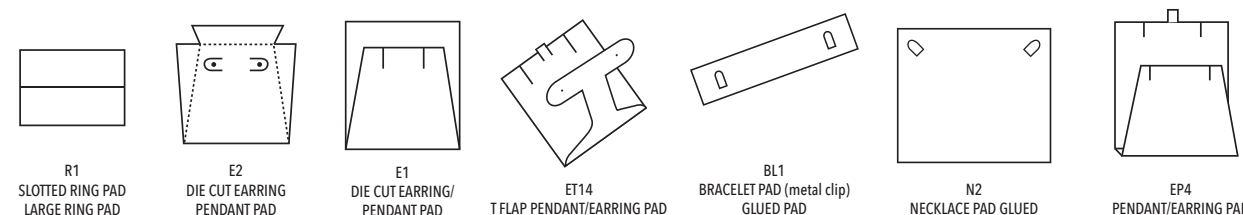

**FOIL / PAD PRINT**

F: inside liner and packer lid / PP: inside top liner and packer lid  
 12+ 35¢ each  
 144+ 32¢ each  
 504+ 26¢ each

Minimum 12 per style.  
 Please allow 2 - 3 weeks for printed items from approved art.



All print orders subject to set-up charges. Applicable artwork, and plate charges may apply. See page 122.

All print orders subject to set-up charges. Applicable artwork, and plate charges may apply. See page 122.

# IN STOCK

## Hinged Boxes

# IN STOCK

## Hinged Boxes



**COORDINATING EUROTOTE**  
See page 77



Outer Box

### Elan

Timeless classic in all white.

- Soft, white leatherette covering
- Coordinating leatherette pads and white satin top liners
- Packaged in a white traditional 2-piece outer box

CODE	DESCRIPTION	SIZE (inches)	PRICE/EACH	
			12+	144+
36021002	Ring (R1)	2 x 2.25 x 1.625	\$3.66	\$3.30
36041002	Large Ring (R1)	3 x 2 x 1.5	\$4.39	\$3.94
36022002	Earring (E1)	2 x 2.25 x 1.5	\$3.66	\$3.30
36084002	Utility T-pad (ET14)	3.5 x 3.5 x 1.375	\$6.51	\$5.75
36093002	Bracelet (BL1)	8.625 x 2.25 x 1	\$6.53	\$5.88
36073002	Necklace (N2)	7.125 x 4.375 x 1.25	\$9.15	\$8.24



**FOIL / PAD PRINT**

F: inside liner and packer lid / PP: all 3 locations  
 12+ 35¢ each  
 144+ 32¢ each  
 504+ 26¢ each

Minimum 12 per style.  
 Please allow 2 - 3 weeks for printed items from approved art.



See page 50.



**COORDINATING EUROTOTE**  
See page 77

### Econolux

Style meets value.

- Soft, white leatherette covering
- White suedine pads and satin top liners
- Packaged in a white tuck outer box (2-piece traditional outer box available)

CODE	DESCRIPTION	SIZE (inches)	PRICE /EACH		2-PIECE CONTAINER PRICE /EACH	
			12+	144+	31	003
36121002	Ring (R1)	1.875 x 2.125 x 1.375	\$2.03	\$1.82	121	\$0.74
36141002	Large Ring (R1)	2.375 x 2 x 1.5	\$2.21	\$1.99	141	\$0.78
36122002	Earring (E2)	1.875 x 2.125 x 1.375	\$2.03	\$1.82	121	\$0.74
36163002	Pendant (E1)	2.25 x 3 x 1.125	\$2.76	\$2.49	163	\$0.81
36132002	T-pad Pendant (ET14)	2.5 x 2.5 x 1.25	\$2.76	\$2.49	132	\$0.81
36193002	Bracelet (BL1)	8 x 2.125 x 1	\$4.25	\$3.82	193	\$1.02
36173002	Necklace (N2)	7 x 4.25 x 1.375	\$7.22	\$6.50	173	\$1.48
36183002	Utility (EP4)	3.875 x 3.25 x 1.375	\$4.25	\$3.82	183	\$1.11
69221000B	Bead Pad for earring box		\$0.68	\$0.56	—	—

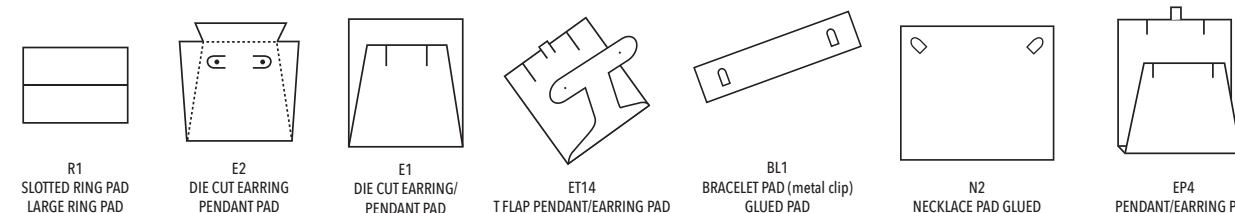

**FOIL / PAD PRINT**

F: inside liner and packer lid / PP: all 3 locations  
 12+ 35¢ each  
 144+ 32¢ each  
 504+ 26¢ each

Minimum 12 per style.  
 Please allow 2 - 3 weeks for printed items from approved art.



See page 50.

**ADDITIONAL CHARGE FOR OPTIONAL 2-PIECE OUTER BOX**



Outer Sleeve



**Bead Pad**

- pad fits stud earring box
- ribbon threads through bead
- ribbon wraps to back and is held by clip

# IN STOCK

## Hinged Boxes

Deliver the 'in-store' experience to your customer's door.  
See page 101 for more information

**COORDINATING EUROTOTE**  
See page 77



### Gold Galleria

A new gold standard.

- White velour pads and satin top liners
- Packaged in a white traditional 2-piece outer box

CODE	DESCRIPTION	SIZE (inches)	PRICE/EACH
36621073	Ring (R1)	2.125 x 2 x 2	\$1.85
36622073	Earring (E1)	2.125 x 2 x 2	N/A
36641073	Large Ring (R1)	3 x 2 x 2	\$1.97
36684073	Utility T-pad (ET14)	3.5 x 3.5 x 1.5	\$2.51
36693073	Bracelet (BL1)	8.25 x 2.125 x 1.25	\$3.64
36673073	Necklace (N2)	6.25 x 5 x 1.5	\$5.91
36650073	Bangle (R1)	1.25 x 3.75 x 3.125	\$2.85
69621000B	Bead Pad for earring box		\$0.68



### E-Commerce Jewelry Boxes

Deliver the 'in-store' experience to your customer's door.  
See page 101 for more information

**COORDINATING EUROTOTE**  
See page 77



### Horizon

The gold standard in a classic white, burgundy and black.

- White velour pads and satin top liners
- Packaged in a white traditional 2-piece outer box

CODE	DESCRIPTION	SIZE (inches)	12+	144+
36621 ___	Ring (R1)	2.125 x 2 x 2	\$2.75	\$2.47
36622 ___	Earring (E1)	2.125 x 2 x 2	\$2.75	\$2.47
36641 ___	Large Ring (R1)	3 x 2 x 2	\$3.25	\$2.92
36684 ___	Utility T-pad (ET14)	3.5 x 3.5 x 1.5	\$4.38	\$3.57
36632 ___	T-Pad Pendant (ET14)	2.75 x 2.75 x 1.375	\$3.76	\$3.38
36693 ___	Bracelet (BL1)	8.25 x 2.125 x 1.25	\$6.00	\$5.40
36673 ___	Necklace (N2)	6.25 x 5 x 1.5	\$9.74	\$8.76
36650 ___	Bangle (R1)	1 x 3.75 x 3.125	\$4.69	\$4.24
69621000B	Bead Pad for earring box		\$0.68	\$0.56
<b>BLACK PADS AVAILABLE (3 SIZES)</b>				
36621153B	Single Ring Pad (black)	2.125 X 2 box w/pad	\$2.75	\$2.47
69622153B	Stud Earring Pad (black)	2.125 x 2 pad only	\$0.27	\$0.27
69633153B	Pend/Earring Pad (black)	2.75 x 2.75 pad only	\$0.78	\$0.78

Available Colors



- Bead Pad**
- pad fits stud earring box
  - ribbon threads through bead
  - ribbon wraps to back and is held by clip



- Bead Pad**
- pad fits stud earring box
  - ribbon threads through bead
  - ribbon wraps to back and is held by clip



**FOIL / PAD PRINT**  
F: inside liner and packer lid / PP: all 3 locations  
12+ 35¢ each  
144+ 32¢ each  
504+ 26¢ each

Minimum 12 per style.  
Please allow 2 - 3 weeks for printed items from approved art.



**FOIL / PAD PRINT**  
F: inside liner and packer lid / PP: all 3 locations  
12+ 35¢ each  
144+ 32¢ each  
504+ 26¢ each

Minimum 12 per style.  
Please allow 2 - 3 weeks for printed items from approved art.



# IN STOCK

## Jewelry Packaging



Available Colors



### Nano Clutch

Perfect for gifting and on the go, this collection is going places!

- Linea envelope, and pad
- Packaged in a 2-piece matching outer box

CODE	DESCRIPTION	SIZE (inches)	PRICE/EACH	
			12+	144+
09121	Ring (R1)	2.55 X 2.55	\$2.44	\$2.24
09163	Pendant (P3)	4 X 4	\$2.96	\$2.73
09193	Bracelet (BL1R)	9.625 X 3.125	\$4.09	\$3.76
09173	Necklace (N1)	6.625 X 6.625	\$5.60	\$5.15

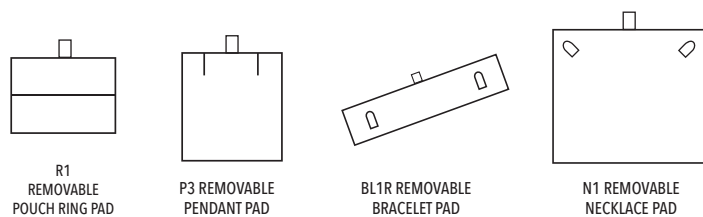

**FOIL / PAD PRINT**  
 F: outside flap and packer / PP: outside flap and packer  
 12+ 35¢ each  
 144+ 32¢ each  
 504+ 26¢ each

Minimum 12 per style.  
 Please allow 2 - 3 weeks for printed items from approved art.



# IN STOCK

## Specialty



### The Drawer Box

Eco-friendly, on trend series.



- Removable resuede recycled pads
- Fixed ring pad with foam
- Made with 100% recyclable Paper Board
- Coordinates with the Nano Pouch for a stunning reveal (earring & pendant)

Minimum one case pack.  
 Please allow 2 - 3 weeks for printed items from approved art.

CODE	DESCRIPTION	SIZE (inches)	CASE PACK	PRICE/EACH	
				50+	500+
31050603	Ring (R1)	2.24 x 2.36 x 1.98	50	\$2.20	\$1.76
31070703	Earring Utility	2.75 x 2.83 x 1.57	50	\$2.53	\$2.03
31101003	Pendant Utility	3.93 x 4 x 1.57	50	\$3.30	\$2.64

**PAD PRINT**  
 PP: box top  
 50+ 35¢ each  
 500+ 32¢ each  
 2500+ 26¢ each



### Vision Box

Unique transparent 3D window box with coordinating display stand.

- Transparent puncture resistant elastic film
- Conforms to hold any jewelry piece
- Coordinating display base (extra)



CODE	DESCRIPTION	SIZE (inches)	PRICE/EACH	
			12+	144+
36301103	Small	2.68 x 2.68 x .75	\$1.00	\$0.80
36302103	Medium	3.5 x 3.5 x .75	\$1.33	\$1.06
36303103	Large	4.25 x 4.25 x .75	\$1.66	\$1.33
69300103	Base (pkg of 12)	2.25 x 2.25 x .62	\$0.83	\$0.66

**PAD PRINT**  
 PP: side of lid - text only - limited space  
 12+ 35¢ each  
 144+ 32¢ each  
 504+ 26¢ each

Minimum 12 per style.  
 Please allow 2 - 3 weeks for printed items from approved art.

All print orders subject to set-up charges. Applicable artwork, and plate charges may apply. See page 122.

All print orders subject to set-up charges. Applicable artwork, and plate charges may apply. See page 122.

# CREATE YOUR OWN LOOK

JEWELRY PACKAGING



## PAPERBOARD SERIES

Stylized lines and the geometric pattern gives this collection an art deco feel.

# IN STOCK

## Paperboard Hinged

JEWELRY PACKAGING



**COORDINATING  
EUROTOTE**  
See page 79



Outer Sleeve



Pads are removable and reversible. Choose white flock or black flock.

## Deco

Iconic black and white.

- Paperboard construction, covered in smooth laminate paper
- Flocked reversible black and white foam pads
- Packaged in individual white sleeves

CODE	DESCRIPTION	SIZE (inches)	CASE PACK	PRICE/EACH	
				50+	500+
31621153D	Ring (R1H)	2 x 2 x 1	50	\$1.39	\$1.27
31622153D	Earring (P3)	2 x 2 x 1	50	\$1.39	\$1.27
31632153D	Large Earring (P3)	2.5 x 2.5 x 1.75	50	\$1.79	\$1.65
31684153D	Utility (P2)	3.75 x 3.75 x 1.5	50	\$2.87	\$2.64
31693153D	Bracelet (BL1)	9 x 2 x 1.125	50	\$2.98	\$2.74
31673153D	Necklace (N2)	6.5 x 8 x 2	50	\$7.16	\$6.59



Recycled Paperboard

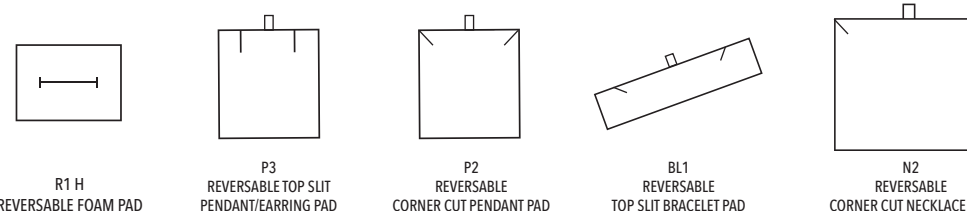

**FOIL / PAD PRINT**  
F: inside and top lid / PP: inside and top lid  
50+ 35¢ each  
500+ 32¢ each  
2500+ 26¢ each

Minimum one case pack.  
Please allow 2 - 3 weeks for printed items from approved art.

All print orders subject to set-up charges. Applicable artwork, and plate charges may apply. See page 122.

# IN STOCK

## 2-Piece Boxes

**COORDINATING EUROTOTE**  
See page 76



### E-Commerce Jewelry Boxes

Deliver the 'in-store' experience to your customer's door



See page 101 for more information

Available Colors



273 - Bronze



153 - Black

## Velocity

Organza ribbon and classic boxes make for perfect partners.

- Texture paper wrapped 2-piece boxes with white flocked foam pads
- Coordinating organza ribbon
- Match with Bronze Geo series and Geo Eurototes

CODE	DESCRIPTION	SIZE (inches)	CASE PACK	PRICE/EACH	
				25+	1000+
31221 ___	Ring (R1)	2.5 x 2.25 x 2	50	\$2.05	\$1.76
31283 ___	Utility (E1)	3 x 3 x 2	50	\$2.85	\$2.45
31293 ___	Bracelet (BL2)	9 x 2.25 x 1.5	25	\$3.91	\$3.35
31273 ___	Necklace (N1)	6.25 x 8 x 2	25	\$5.14	\$4.64

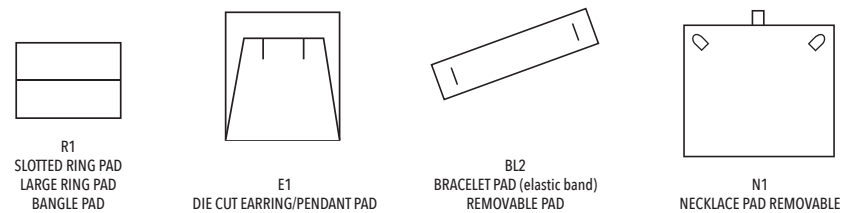

**FOIL / PAD PRINT**  
F: inside and top lid / PP: inside and top lid  
25/50+ 35c each  
1000+ 32c each  
2500+ 26c each

Minimum one case pack.  
Please allow 2 - 3 weeks for printed items from approved art.



# IN STOCK

## 2-Piece Boxes

**NEW! COORDINATING ALL PAPER EUROTOTE**  
See page 79



## Romance

Perfect partners in ivory and gold.

- Texture paper wrapped 2-piece boxes with white flocked foam pads
- Coordinating organza ribbon
- Match with Cream All Paper Eurototes

CODE	DESCRIPTION	SIZE (inches)	CASE PACK	PRICE/EACH	
				50+	1000+
31221863	Ring (R1)	2.5 x 2.25 x 2	100	\$1.87	\$1.77
31222863	Earring (E1)	2 x 1.5 x 1.187	100	\$1.78	\$1.60
31263863	Utility (P3)	3 x 3 x 2.125	100	\$2.11	\$1.93
31293863	Bracelet (BL1)	9 x 2.375 x 1.5	50	\$3.18	\$2.81
31273863	Necklace (N2)	6.375 x 8 x 2	50	N/A	

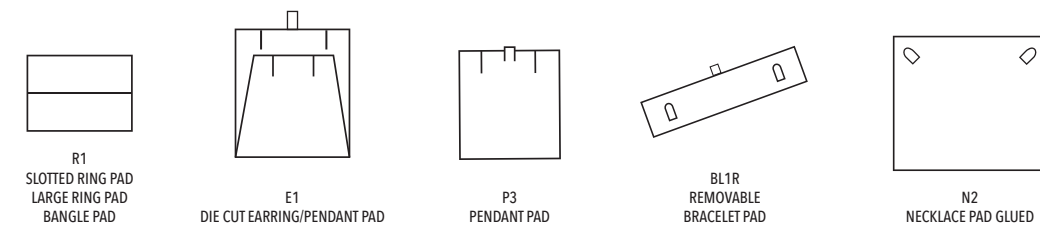

**FOIL / PAD PRINT**  
F: inside and top lid / PP: inside and top lid  
50/100+ 35c each  
1000+ 32c each  
2500+ 26c each

Minimum one case pack.  
Please allow 2 - 3 weeks for printed items from approved art.



# IN STOCK

## 2-Piece Boxes

# IN STOCK

## Paperboard Hinged

JEWELRY PACKAGING

JEWELRY PACKAGING



**COORDINATING EUROTOTE**  
See pages 77

### Shadow

Shimmery grey exterior, featuring a wave reveal.

- Texture paper wrapped 2-piece boxes with white flocked foam pads
- Match with Rope Handle Eurototes
- No packer/no sleeve

CODE	DESCRIPTION	SIZE (inches)	CASE PACK	PRICE/EACH	
				50+	1000+
31511308	Charm (C1)	2 x 2 x 1	100	\$1.24	\$1.19
31521308	Ring/Earring (R1H)	2 x 2 x 1.75	100	\$1.35	\$1.28
31563308	Pendant/Earring (P2)	3.5 x 3.5 x 1.25	50	\$1.88	\$1.75
31593308	Bracelet (BL2)	9 x 2 x 1	50	\$2.69	\$2.54
31573308	Necklace (N1)	6 x 6 x 1.5	50	\$3.30	\$3.26



Recycled Paperboard

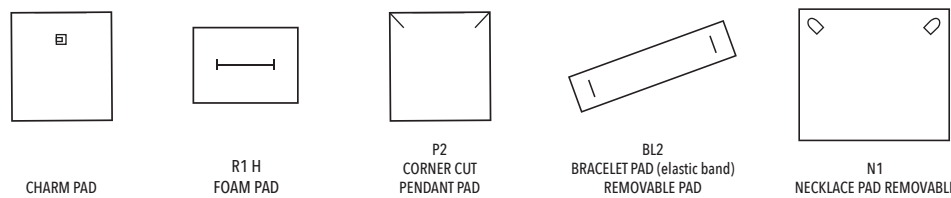

**FOIL / PAD PRINT**  
F: inside and top lid / PP: inside and top lid  
50/100+ 35¢ each  
1000+ 32¢ each  
2500+ 26¢ each

Minimum one case pack.  
Please allow 2 - 3 weeks for printed items from approved art.



See page 50.



**COORDINATING EUROTOTE**  
See pages 77

### Royale

Hinged, white paperboard boxes covered in finely ribbed paper with gold accent lines.

- Texture paper wrapped hinged boxes with white flocked foam pads
- Match with Rope Handle Eurototes
- Packaged in individual white sleeves

CODE	DESCRIPTION	SIZE (inches)	CASE PACK	PRICE/EACH	
				50+	1000+
31545003	Ring/Earring (R1H)	2.5 x 2 x 1.5	100	\$1.03	\$1.09
31533003	Pendant/Earring (P2)	2.75 x 2.75 x 1	100	\$1.24	\$1.15
31560003	Utility (P3)	3.5 x 3.5 x 1	50	\$1.85	\$1.76
31580003	Bracelet (BL2)	8.125 x 2.125 x 1	50	\$2.32	\$2.19
31575003	Necklace (N1)	6.5 x 4.5 x 1	50	\$3.30	\$3.10



Recycled Paperboard

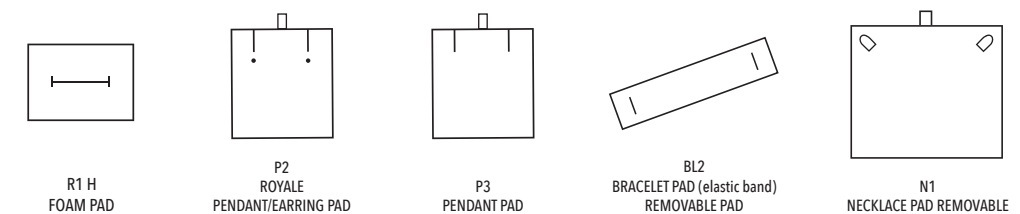

**FOIL / PAD PRINT**  
F: inside and top lid / PP: inside and top lid  
50/100+ 35¢ each  
1000+ 32¢ each  
2500+ 26¢ each

Minimum one case pack.  
Please allow 2 - 3 weeks for printed items from approved art.



See page 50.

All print orders subject to set-up charges. Applicable artwork, and plate charges may apply. See page 122.

All print orders subject to set-up charges. Applicable artwork, and plate charges may apply. See page 122.

# SPECIAL ORDER

## Nest Boxes



100% Recycled Board

Available Colors



849 - Red 192 - Solid White



231 - Black 138 - White



505 - Kraft

### Berkeley

Simple yet striking keyline design collection.

- Gloss paper
- Fully customizable
- White flocked platform inserts

CODE	SIZE (inches)	CASE PACK	PRICE/EACH	
			100+	1000+
32201	3 x 3 x 1.25	100	\$1.81	\$1.66
32202	3.5 x 3.5 x 2	100	\$2.18	\$2.18
32203	5 x 5 x 1.5	100	\$2.73	\$2.73
32204	9 x 4.5 x 2*	100	\$3.43	\$3.43

\* 849 - Red and 505 - Kraft are not available in this size.

**FOIL / PAD PRINT**  
 F: top lid only / PP: top lid only  
 100+ 35¢ each  
 1000+ 32¢ each  
 2500+ 26¢ each

Minimum one case pack.  
 Estimated lead time - Please allow 3 weeks for unprinted items and 4 weeks for printed items from approved art.

# SPECIAL ORDER

## Nest Boxes



100% Recycled Board

CODE	PRICE /EACH	
	50+	1000+
31011	\$0.70	\$0.63
31021	\$0.74	\$0.68
31032	\$0.83	\$0.75
31033	\$0.98	\$0.89
31036	\$1.04	\$0.95
31034	\$1.14	\$1.03
31053	\$1.15	\$1.04
31065	\$1.61	\$1.46
31082	\$1.08	\$0.98
31085	\$2.05	\$1.86



### Cotton Filled Nest Boxes

#### Mix & Match!

Available Colors



CODE	SIZE (inches)	CASE PACK	061	000K	007	008	009	029	354	353	045	015S	015P	055	093
31011	1.75 x 1.125 x .625	100	✓	✓	✓	✓	-	-	-	-	-	✓	✓	-	-
31021	2.5 x 1.5 x .875	100	✓	✓	✓	✓	✓	✓	✓	✓	✓	✓	✓	✓	✓
31032	3 x 2.125 X 1	100	✓	✓	✓	✓	✓	✓	✓	✓	✓	✓	✓	✓	✓
31033	3.5 x 3.5 x 1	100	✓	✓	✓	✓	✓	✓	✓	✓	✓	✓	✓	✓	✓
31036	3.5 x 3.5 x 1.5	100	-	✓	✓	✓	-	-	-	-	-	-	✓	✓	-
31034	3.5 x 3.5 x 2	100	-	✓	✓	✓	-	-	-	-	-	✓	✓	✓	-
31053	5.25 x 3.75 x .875	100	✓	✓	✓	✓	✓	✓	✓	✓	✓	✓	✓	✓	✓
31065	6 x 5 x 1	50	-	✓	✓	✓	✓	✓	✓	-	✓	✓	✓	✓	✓
31082	8 x 2 x .875	100	-	✓	✓	✓	✓	-	✓	-	-	✓	✓	✓	✓
31085	8 x 5.5 x 1.25	50	✓	✓	✓	-	-	-	-	-	-	-	✓	-	-



CODE	SIZE (inches)	CASE PACK	098	099	060	056	028	025	026	076	075	081	067	019
31011	1.75 x 1.125 x .625	100	-	-	✓	-	-	-	-	✓	✓	-	-	-
31021	2.5 x 1.5 x .875	100	✓	✓	✓	✓	✓	✓	✓	✓	✓	✓	✓	✓
31032	3 x 2.125 X 1	100	✓	✓	✓	✓	✓	✓	✓	✓	✓	✓	✓	✓
31033	3.5 x 3.5 x 1	100	✓	✓	✓	✓	✓	✓	✓	✓	✓	✓	✓	✓
31036	3.5 x 3.5 x 1.5	100	-	-	-	✓	-	-	-	✓	✓	-	-	-
31034	3.5 x 3.5 x 2	100	-	-	-	✓	-	✓	-	✓	✓	-	-	-
31053	5.25 x 3.75 x .875	100	✓	✓	✓	✓	✓	✓	✓	✓	✓	✓	✓	✓
31065	6 x 5 x 1	50	✓	✓	✓	✓	-	✓	✓	✓	✓	✓	-	-
31082	8 x 2 x .875	100	-	✓	✓	✓	-	-	-	✓	✓	-	-	-
31085	8 x 5.5 x 1.25	50	-	-	✓	-	-	-	-	✓	✓	-	-	-

**FOIL / PAD PRINT**  
 F: top lid only / PP: top lid only  
 50/100+ 35¢ each  
 1000+ 32¢ each  
 2500+ 26¢ each

Minimum one case pack.  
 Estimated lead time - Please allow 3 weeks for unprinted items and 4 weeks for printed items from approved art.

# IN STOCK

## Nest Boxes



These boxes match our **Damask Paper Shoppers** - page 85 and **Damask Pouches** - page 54

## Damask

Style and substance in a simple packaging combination.

- Black and white 2-piece box
- 100% recycled board box
- Cotton fill pad wrapped with damask patterned tissue
- See our matching bag and pouch to complete your collection

CODE	DESCRIPTION	SIZE (inches)	CASE PACK	PRICE / EACH	
				100+	1000+
31570153D	Earring	3 x 2.125 x 1	100	\$0.65	\$0.63
31555153D	Brooch	3.5 x 3.5 x 1	100	\$0.79	\$0.76
31564153D	Bracelet	8 x 2 x .875	100	\$0.93	\$0.90
31558153D	Necklace	6 x 5 x 1	100	\$1.35	\$1.30

Minimum order is one case pack.

White Swirl Pattern



## White Economy

Sometimes a simple box is all you need!

- Made with 100% recycled board covered with white swirl paper
- Cotton filled to hold jewelry in place

CODE	DESCRIPTION	SIZE (inches)	CASE PACK	PRICE / EACH	
				50+	1000+
31502103	Charm	2.5 x 1.5 x .875	100	\$0.42	\$0.38
31570103	Earring	3 x 2.125 x 1	100	\$0.44	\$0.39
31555103	Brooch	3.5 x 3.5 x 1	100	\$0.49	\$0.46
31564103	Bracelet	8 x 2 x .875	100	\$0.55	\$0.52
31558103	Necklace	6 x 5 x 1	50	\$0.84	\$0.80
31576103	Large Necklace	8 x 5.5 x 1.25	50	\$1.41	\$1.33
31259103	Stand-Up Bangle	3.5 x 2 x 2 x 2	100	\$2.22	\$1.99

Minimum order is one case pack.



100% Recycled Board



**FOIL / PAD PRINT**  
F: top lid only / PP: top lid only  
100+ 35¢ each  
1000+ 32¢ each  
2500+ 26¢ each

Estimated lead time: 2 - 3 weeks for printed items from approved art.



100% Recycled Board



**FOIL / PAD PRINT**  
F: top lid only / PP: top lid only  
50/100+ 35¢ each  
1000+ 32¢ each  
2500+ 26¢ each

Estimated lead time: 2 - 3 weeks for printed items from approved art.

# IN STOCK

## Jewelry Folders

### Passport Jewelry Folders

Designed with stylish envelope closure, snaps tight to keep jewels secure.

- Linea exteriors, satin interior
- Packaged in a 2-Piece white outer box
- Two colors soft white and black
- Case pack of 12



CODE	DESCRIPTION	SIZE (inches)	PRICE / EACH	
			12+	144+
367950	Bracelet	8.25 x 1.75 x 0.625	\$4.76	\$4.30
367900	Necklace/Pearl	6 x 8 x 0.625	\$7.55	\$6.81



**FOIL / PAD PRINT**

Bracelet: F and PP: inside bottom flap and packer lid  
Necklace: PP: top flap / F and PP: inside flap and packer lid  
12+ 35¢ each  
144+ 32¢ each  
504+ 26¢ each

Estimated lead time: 2 - 3 weeks for printed items from approved art.

159W - Black  
NO OUTSIDE PRINT

879B - Bronze



009P - Pearl

### Global Jewelry Folders

Wide gusset folder for larger pieces.

- Bronze and pearl linea
- Black faux suede
- Satin interior and magnetic closure
- Packaged in a 2-Piece matching outer box
- Case pack of 12

CODE	SIZE (in.)	PRICE / EACH	
		12+	144+
36790	5.5 x 7.5 x 1.375	\$10.60	\$9.32



**FOIL / PAD PRINT**

PP: top flap / F and PP: inside flap and packer lid  
12+ 35¢ each  
144+ 32¢ each  
504+ 26¢ each

Estimated lead time: 2 - 3 weeks for printed items from approved art.

### Hoop Earring Folder

Black ultrasuede folder with top stitch finish and black interior. Holds hoop earrings up to 2.75" in diameter.

- Packaged in a white 2-Piece outer box
- Case pack of 12



**FOIL / PAD PRINT**

F: packer lid / PP: packer lid  
12+ 35¢ each  
144+ 32¢ each  
504+ 26¢ each

Estimated lead time: 2 - 3 weeks for printed items from approved art.

All print orders subject to set-up charges. Applicable artwork, and plate charges may apply. See page 122.

All print orders subject to set-up charges. Applicable artwork, and plate charges may apply. See page 122.

# CREATE YOUR OWN LOOK

## TELL YOUR BRAND STORY CREATE YOUR UNIQUE IDENTITY



### Create Your Own Look in 7 Easy Steps

Speak to your sales representative for a consultation.

## Looking for 100% custom design? Design your very own jewelry packaging.

### STEP 1:

Choose your box style.  
We have access to endless design and looks. You dream it, we can create it.  
Choose from wood, plastic, MDF and paperboard shells.  
Select hinged or 2-piece.  
MOQ:  
Plastic or Metal 2,500  
Wood 1,000  
Paperboard 5,000

### STEP 2:

Choose your covering and color.  
Leatherette, velvet, paper.  
Design your texture—hundreds to choose from, or create your own. Brushed leatherette, embossed papers, smooth, textured, Select from our color books, or use Pantone to specify your exact colors.

### STEP 3:

Specify the interior.  
Select pad color and material for inside lid.  
Leatherette, brushed leatherette, flocked, velvet, velour.  
Decide on the top interior material—leatherette, brushed leatherette, satin, flocked, velvet.  
Select color—white, black, ivory are most common.  
Option—create a reveal with contrasting color.

### STEP 4:

Design your packer.  
2- piece box or sleeve.  
Often you can use the same material or create a coordinating color.  
Option -- add die cuts at bottom for ribbon, and/or reveal for contrasting color.



### STEP 5:

Design logo placement.  
Areas to consider:  
Inside box lid (Top Satin)  
Packer Lid (can be centered, or placed at lower corner if using ribbon)  
Top Lid



### STEP 6:

Select your pad designs. (See page 51)

### STEP 7:

Email your artwork.  
Artwork ultimately needs to be in Vector file format. Your graphic designers should be able to assist you. Gunther Mele is also available to provide artwork assistance and full service design, cost is \$75/hour, min half hour charge.

CYOL has 16-20 weeks lead time. (Time frames based on signed approved artwork, quote and deposit).  
Printing and pre-production samples included at no extra charge.

### Please note:

Logos with intricate lines and details (such as diamonds), often will not translate in small print areas, such as top satins. Designs with text and simple outlines work best for inside of ring boxes, etc. Reps and our designers will advise you when artwork should be modified to produce best results.

To ensure accuracy and best quality, signatures are required on all artwork documents and quote documents where noted. Production will not commence until all artwork, quotes and deposits are finalized and signed off. Your rep is available to work with you to ensure all documentation is completed to prevent delays. Please ensure your email access is update date.

## Complete your look!

Bags, Tissue, Pouches, Ribbon, Displays, Necklace folders, and more!

Select from our in stock or create your own. Gunther Mele is your one stop for all your needs.

Our sales representative can help you design all your packaging and displays to tell your unique brand story.

# CREATE YOUR OWN LOOK

### RING PADS

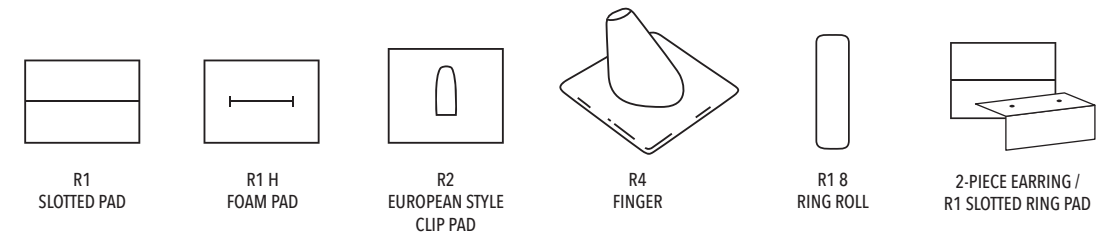

### EARRING PADS

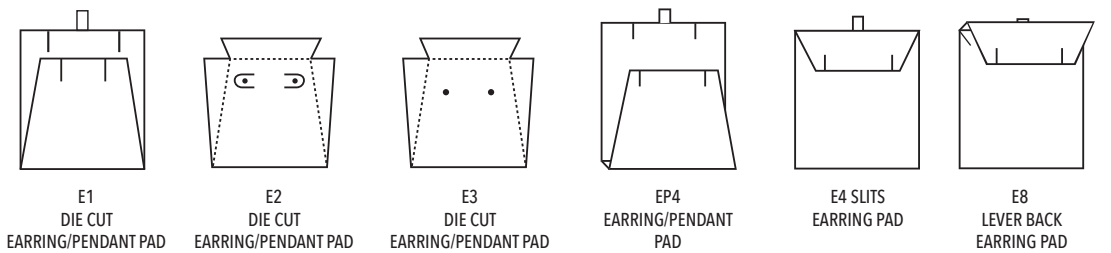

### EARRING/ PENDANT PADS

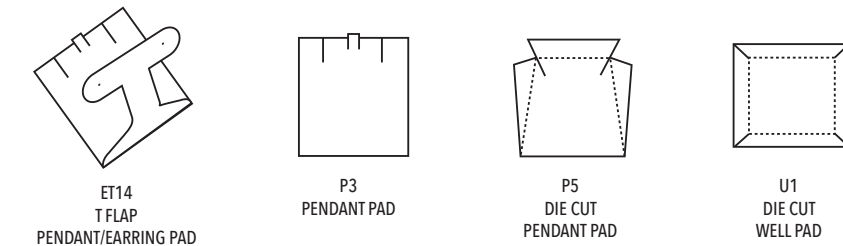

### BRACELET AND WATCH PADS

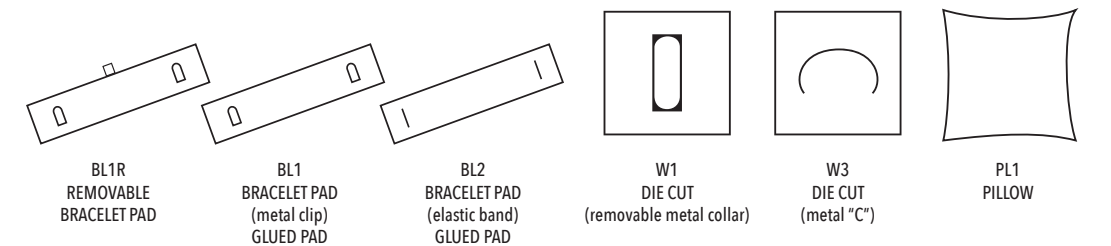

### NECKLACE PADS

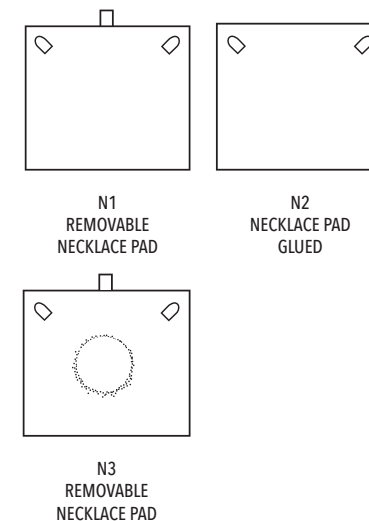

### TRIPLE FLIP PADS

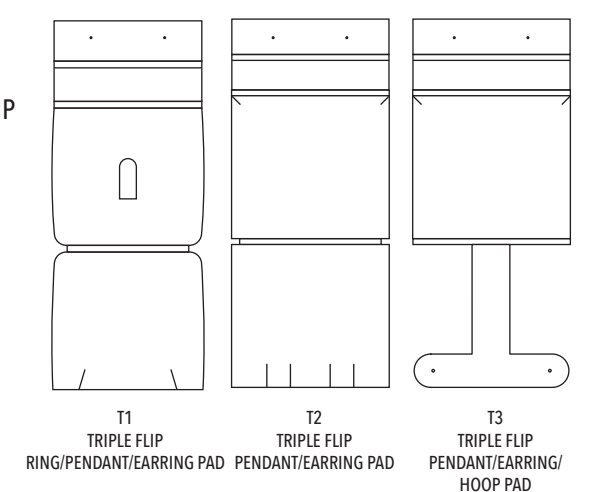

# IN STOCK

## Gift Card Boxes



Gift Cards  
Not Included.

### Black Gift Card Box with Ribbon

Estimated lead time: 2 - 3 weeks for printed items from approved art.  
Minimum order is one case pack.

CODE	SIZE (inches)	CASE	PRICE/EACH	
			100+	1000+
31040315	4 x 3 x .625	100	\$1.53	\$1.19

**FOIL / PAD PRINT**  
F and PP: inside and top lid  
100+ 35¢ each  
1000+ 32¢ each  
2500+ 26¢ each

### Pewter Gift Card Box with Ribbon

Estimated lead time: 2 - 3 weeks for printed items from approved art.  
Minimum order is one case pack.

CODE	SIZE (inches)	CASE	PRICE/EACH	
			50+	1000+
31040742	7.5 x 4.25 x .625	50	\$2.19	\$1.97

**FOIL / PAD PRINT**  
F and PP: inside and top lid  
50+ 35¢ each  
1000+ 32¢ each  
2500+ 26¢ each



Gift Cards  
Not Included.

### Gift Certificate and Box

Estimated lead time: 2 - 3 weeks for printed items from approved art.

CODE	SIZE (inches)	CASE PACK	PRICE/EACH
			100+
09221002B	White Gift Certificate Box Only	100	\$1.81
18197	English Gift Certificate 6.375 x 3.125" folded	100	\$0.77
18196	French Gift Certificate 6.375 x 3.125" folded	100	\$0.77

**FOIL / PAD PRINT**  
F and PP: certificate and top lid  
100+ 35¢ each  
1000+ 32¢ each  
2500+ 26¢ each

Gift certificates are pre-numbered.

Minimum order is one case pack.



Sold  
separately.

FRONT

*A Gift For You*

*Un cadeau pour vous*

YOUR logo HERE

N° 001

Gift Certificate Record

To: \_\_\_\_\_

Amount: \_\_\_\_\_ Dollars \$

From: \_\_\_\_\_

Date: \_\_\_\_\_

Issued by: \_\_\_\_\_

Expires: \_\_\_\_\_

GUNTHERMELE

N° 001

perforation

# SPECIAL ORDER

## Gift Card Boxes

Estimated lead time: 3 weeks for unprinted items and 4 weeks for printed items from approved art.



15 - Black

### Monte Carlo Gift Card Box

People love gift cards, this box takes the presentation to a new level.

- Smooth paper hinged box with magnetic closure
- Removable insert to hold card, just slide in place for secure hold
- Try 15-black with our clear black gloss print GL2

CODE	SIZE (inches)	CASE	PRICE/EACH
			100+
310239 __	5.125 x 4 x 1	100	\$2.71

**FOIL / PAD PRINT**  
F: inside lid only / PP: inside and outside lid  
100+ 35¢ each  
1000+ 32¢ each  
2500+ 26¢ each

Estimated lead time: 3 weeks for unprinted items and 4 weeks for printed items from approved art.

Gift Cards  
Not Included.

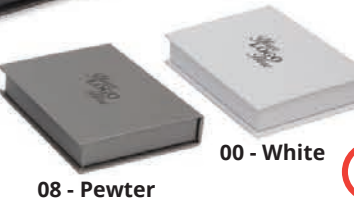

08 - Pewter

00 - White

00 - White

08 - Silver

73 - Gold

### Gift Card Nest Box

- White paperboard platforms
- Interior has same paper for lids and bases

CODE	SIZE (inches)	CASE	PRICE/EACH
			100+
313230 __	3.5 x 2.25 x .75	100	\$1.44

Estimated lead time: 3 weeks for unprinted items and 4 weeks for printed items from approved art.

### Gift Certificate Box

CODE	SIZE (inches)	CASE PACK	PRICE/EACH
			100+
0922100 _ B	Gift Certificate Box Only see color options 6.625 x 3.25 x .5	100	\$1.81

Gift Certificate Box Color:



Minimum order is one case pack.

**FOIL / PAD PRINT**  
F and PP: top lid only  
100+ 35¢ each  
1000+ 32¢ each  
2500+ 26¢ each

### IN STOCK Finishing Touches

Available to finish the look of your gift certificate/card.

Stretch Loops (100 pack min.)

09500607 6"	Gold	\$0.13/ea
09500608 6"	Silver	\$0.09/ea
09501007 10"	Gold	\$0.14/ea
09501008 10"	Silver	\$0.13/ea



Dress it up with printed ribbon!  
See page 114.



# IN STOCK

## Pouches

### Microfiber Pouches

• Minimum case pack 100

CODE	COLOR	SIZE (inches)	PRICE / EACH	
			100+	500+
09040315	Black	4 x 3	\$1.22	\$1.03
09050415	Black	5-1/2 x 4	\$1.71	\$1.47
09040311	Blue	4 x 3	\$1.22	\$1.03
09050411	Blue	5-1/2 x 4	\$1.71	\$1.47



# IN STOCK

## Pouches

### Geo Series

• Minimum case pack 12.

Estimated lead time: 2 - 3 weeks for printed items from approved art.



CODE	TYPE	SIZE (in.)	PRICE / EACH	
			12+	144+
A 09030415B	Geo Pouch with Black Box	3 x 4	\$2.19	\$1.84
B 09030456P	Geo Pouch with Purple Box	3 x 4	\$2.19	\$1.84
C 09030427T	Geo Pouch with Bronze Box	3 x 4	\$2.19	\$1.84

**FOIL / PAD PRINT**  
 F and PP: pouch and packer lid  
 12+ 35¢ each  
 144+ 32¢ each  
 504+ 26¢ each

### Damask Pouches



Zippered section

### Envelope Pouches with snap closure



Available in black. Packaged in a 2-piece, pearlized, dark grey outer box.

### Microfiber Bell Pouches +

• Minimum case pack of 12



# SPECIAL ORDER

## Natural Jute and Natural Cotton Pouches

• Minimum 100 per size.

Estimated lead time: 6 weeks for printed items from approved art.



**FOIL PRINT**  
 100+ 32¢ each  
 1000+ 29¢ each  
 2500+ 24¢ each

### Natural Cotton - FOIL PRINT ONLY

CODE	SIZE (in.)	PRICE / EACH	
		100+	1000+
09030400NC	3 x 4	\$0.53	\$0.44
09050600NC	5 x 6	\$0.77	\$0.63
09061000NC	6 x 10	\$1.15	\$0.94
09081200NC	8 x 12	\$1.53	\$1.26

### Natural Jute - NO PRINT

CODE	SIZE (in.)	PRICE / EACH	
		100+	1000+
09050500NJ	3 x 5 1/2	\$1.00	\$0.82
09050600NJ	5 x 6	\$1.19	\$0.97
09061000NJ	6 x 10	\$1.58	\$1.28

### White Leatherette Pouches



Gold Metallic Pouches



### Velveteen Pouches



- Black - 615
- Royal Blue - 611
- Brown - 612
- Green - 667
- Burgundy - 666

\*\*See chart for 2-piece SPECIAL ORDER outer box for the Velveteen pouches.



### Wedding Pouches +

White satin pouch with a white 2-piece outer box.

• Minimum case pack 12



• Minimum case pack of 100

CODE	TYPE	SIZE (in.)	CASE PACK	PRICE/EACH	
				100+	1000+
A 09040515D	Large Damask Pouch	5.5 x 4	100	\$1.77	\$1.54
B 09030315D	Small Damask Pouch	3 x 3	100	\$1.29	\$1.54
C 09304715	Large Envelope Pouch	3 x 4	100	\$2.45	\$2.33
D 09203715	Small Envelope Pouch	2.375 x 2.75	100	\$1.90	\$1.75
E 09525115B	Large Microfiber Bell Pouch	4.375 x 5.375	12	\$1.22	\$1.04
F 09324115B	Small Microfiber Bell Pouch	3.25 x 4.5	12	\$0.97	\$0.84
G 09314700	Large White Leatherette Pouch	3 x 4	100	\$0.69	\$0.58
H 09203700	Small White Leatherette Pouch	2.75 x 3.25	100	\$0.56	\$0.49
I 09314807	Gold Metallic Pouch	3 x 4	100	\$0.69	\$0.71
J 09405 ___	*Velveteen Pouches	4 x 5.5	100	\$0.51	\$0.42
K 09314 ___	*Velveteen Pouches	3 x 4	100	\$0.42	\$0.35
31314003	White 2-piece outer box**	3.25 x 4.25	100	\$0.95	\$0.86
31065000K	White 2-piece outer box	6 x 5 x 1	50	\$1.61	\$1.46
L 37501006	White Wedding Pouches	1.875 x 2.5	12	\$1.99	\$1.66

\* See photo for color code

### Economical packaging for inexpensive items or repairs.

Estimated lead time: 2 - 3 weeks for printed items from approved art.

**FOIL / PAD PRINT**  
 100+ 35¢ each  
 1000+ 32¢ each  
 2500+ 26¢ each

+ Bell Pouches and Wedding Pouch minimums:

**FOIL / PAD PRINT**  
 12+ 35¢ each  
 144+ 32¢ each  
 504+ 26¢ each

### Organza Colors (Not exactly as shown.)

- Black - 030
- Hunter - 589
- Lt. Blue - 305
- Purple - 465
- Orange - 750
- Red - 250
- Baby Maize - 617
- Pastel Green - 513
- Turquoise - 340
- Silver - 012
- Navy - 370
- Burgundy - 276
- Lavender - 430
- Olive - 563
- Pink - 115
- Ivory - 810
- Fruit Punch - 155
- Royal - 350
- White - 029
- Smoke Blue - 337
- Ultra Violet - 467
- Copper - 073
- Mint - 530
- Gold - 690
- Mauve - 161
- Yellow - 645
- Fuchsia - 187

A is only available in Silver, White, Pink, Lavender, Gold and Ivory.

F not available in Fruit Punch, Orange, Royal, Turquoise and Yellow.

G is only available in Silver, White, Pink, Red, Burgundy, Lt. Blue, Royal, Lavender, Mint, Olive, Gold and Ivory.

### Organza

CODE	SIZE (inches)	PRICE / EACH	
		100+	1000+
A 09905 ___	2 x 2.5	\$0.35	\$0.27
B 09910 ___	3 x 4	\$0.37	\$0.29
C 09915 ___	4 x 5.5	\$0.49	\$0.39
D 09920 ___	5 x 6.5	\$0.55	\$0.44
E 09925 ___	5.5 x 9	\$0.81	\$0.65
F 09930 ___	6 x 14	\$0.93	\$0.75
G 09950 ___	22 x 25 (not shown)	\$3.18	\$2.54

Minimum 100 per size/color.

Estimated lead time: 6 weeks for printed items from approved art. Foil printed to be determined.

**FOIL PRINT - TBD**  
 100+ 35¢ each  
 1000+ 32¢ each  
 2500+ 26¢ each



# IN STOCK

## Jewelry Care

Available for immediate shipment.

**New**



### We care about your jewelry as much as you do!

We care about your jewelry, that's why we use better ingredients, better packaging, and you get better performance to keep you sparkling brighter all day long. Use Lavish everyday to safely and conveniently make your jewelry sparkle and shine more than it ever has.



#### Lavish Jewelry Bath

Jewelry bath includes 1 pod of our jewelry cleaner concentrate. An effective jewelry cleaner that can be used on all jewelry from Pearls and Opals to Diamonds without the risk of damage.

8 fl. oz. (236 ml)  
**04530000** \$4.27 ea  
 50 per case pack



#### Lavish Polishing Cloth

Gold, Silver, Platinum oh my!

Bring back the shine of all your metals with the Lavish signature polishing cloth. Our polishing cloth is infused with a gentle and effective polishing compound that will bring back the luster and shine to your jewelry. Great for use on gold, silver, platinum, and other precious metals.

Note: To avoid the possibility of small scratches, care should be taken to avoid contact with stones other than diamonds. 8 fl. oz. (236 ml)

6" x 8" - Slate Grey with Vellum Envelope  
**04540000** \$4.24 ea  
 50 per case pack



#### Handling Gloves

White microfiber. One size fits all. The natural oils in our skin can often leave displeasing marks on jewelry. Our microfiber, lint-free gloves are ideal for handling and protecting your most precious inventory.

**05000296** \$2.50 /pair  
 Minimum order - 6 pairs



#### Lavish Foam

Our Lavish Jewelry Cleaning Foam is our #1 customer favorite product. The foam is a special blend of bio-based surfactants that coalesce in a foam to efficiently break down the daily buildup of grime and allow it to be easily rinsed away leaving nothing but sparkle and shine. The foam is dispensed through a non-aerosol pump foamer, so there are no nasty propellants to damage our ozone layer.

1.69 fl. oz. (50 ml) **04510050** \$5.13 ea  
 2.5 fl. oz. (75 ml) **04510075** \$6.43 ea  
 48 per case pack per size



#### Lavish Click Clean Pen

The Lavish Click Clean Pen is the ultra portable, ultra quick way to put the bling back in your ring. The non-toxic formulation is safe for all your jewelry and is ready to go whenever, wherever you are. The one-handed click action gives you control so you can dispense just the right amount of cleaning solution onto your jewelry. The soft brush tip makes it easy to get into hard to reach areas of your jewelry and underneath stones.

.108 fl. oz. (3.2 ml)  
**04520000** \$5.29 ea 50 per case pack

# SPECIAL ORDER

## Jewelry Care

Estimated lead time: 3-4 weeks for printed items from approved art.

**New**

### Customize with your store brand!

Quality professional jewelry care, such as LAVISH, starts as an add-on sale or complimentary gift with purchase and keeps customers coming back for more. Every time customers clean their jewelry with customized LAVISH jewelry care, they will think of your store.



## Full Color Digital Printed Labels

Create your own full color look or our artist can create a design for your approval. Estimated lead time: 3 - 4 weeks for custom printed items from approved art.



#### Lavish Jewelry Bath

8 fl. oz. (236 ml)  
**04530000C** \$4.27 ea  
 Minimum order 150 jars



#### Lavish Polishing Cloth

6" x 8" - Slate Grey with Vellum Envelope  
**04540000C** \$4.24 ea

Screen print colors: Black, Silver, Gold or White  
 Minimum order 200 cloths



#### Lavish Foam

1.69 fl. oz. (50 ml) **04510050C** \$5.13 ea  
 2.5 fl. oz. (75 ml) **04510075C** \$6.43 ea  
 Minimum order 96 bottles per size



#### Lavish Click Clean Pen

.108 fl. oz. (3.2 ml)  
**04520000C** \$5.29 ea  
 Minimum order 100 pens



Non-Toxic

Made in the USA

Biodegradable

Safe

User and Eco Friendly. Lavish is a bio-based cleaning formula that contains no harsh chemicals, peroxides, phosphates, or ammonia.

Lavish was developed and is made by a 3rd generation jeweler/jeweler's whose ambition is to provide you with the safest, and most effective product available.

Lavish is biodegradable. It breaks down rapidly and completely, meaning it will not contaminate or pollute our water, or our environment.

Lavish is safe for you, your jewelry, and our planet. From creating jewelry to your hair-salon-places, Lavish will bring back the sparkle and shine without the worry.



## Diamond & Gem Cloths

Microfiber Cloth removes small dust, oily film, fingerprints and other residue from fine jewelry. Chemical Free. Lint Free. AVAILABLE IN LIGHT BLUE ONLY. Estimated lead time: 4 - 6 weeks for custom printed cloths from approved art.

8 x 8" Blue Cloth **04780800C** \$3.04 ea  
 Minimum order is 144 cloths.

All print orders subject to set-up charges. Applicable artwork, and plate charges may apply. See page 122.

All print orders subject to set-up charges. Applicable artwork, and plate charges may apply. See page 122.

# IN STOCK

## Jewelry Care

Estimated lead time: 2 - 3 weeks for printed items from approved art.

### Repair Envelopes

 **NO PLATE CHARGES!**

CODE	DESCRIPTION	SIZE (in)	1000	3000	5000	10000
A 09850000	2-Part NCR	4.25 x 9	\$0.27	\$0.26	\$0.21	\$0.17
B 09845200	Plain-no perf., text or numbers	3.5 x 6.125	\$0.12	\$0.10	\$0.09	\$0.08
C 09845300	Double Perforated	3.5 x 6.125	\$0.21	\$0.18	\$0.15	\$0.14
D 09845400	Single Perforated	3.5 x 6.125	\$0.22	\$0.19	\$0.16	\$0.15
E 09850000E	2-part NCR - NO PRINT	4.25 x 9	\$0.23	\$0.23	\$0.23	\$0.23

• Prices include one color printing. A second color is \$ 0.029/each.  
Minimum 1000 per style. Printing colors: Black, Red, Green and Blue



Please allow 2 - 3 weeks for printing.  
\$37 set-up charge applies.

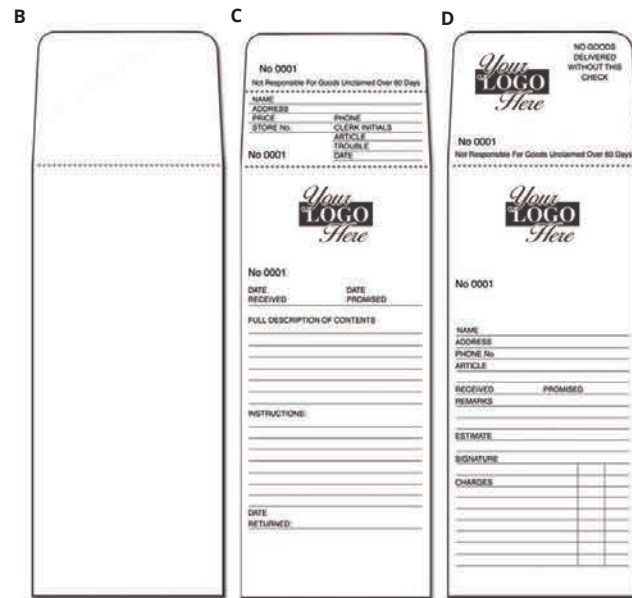

### Tags and Miscellaneous Accessories



CODE	DESCRIPTION	PACK MIN.	PRICE
E 08270207	Plastic Ring Tags - Gold	Box/1000	\$114.81
F 08270208	Plastic Ring Tags - Silver	Box/1000	\$114.81
G 08090707	Plastic With String Tags - Gold	Box/1000	\$114.81
H 08090708	Plastic With String Tags - Silver	Box/1000	\$114.81
I 08810800	Super Mylar Ring Tags - Wide	Box/1000	\$43.87
J 08810700	Super Mylar Ring tags - Narrow	Box/1000	\$30.16
08833000	Fine Pen Marker (not shown)	1	\$12.69

Available for immediate shipping for above items.

All print orders subject to set-up charges. Applicable artwork, and plate charges may apply. See page 122.

# JEWELRY DISPLAY



# CREATE YOUR OWN LOOK

**Step 1:** Choose your platforms profile. These can be made in any size.

**Step 2:** Choose your elements. Options: magnetics or hide a tag.

# CREATE YOUR OWN LOOK

JEWELRY DISPLAY

**REVEAL**  
Shown in Novasuede



**WHISPER**  
Shown in Novasuede



**ECLIPSE**  
Shown in Novasuede

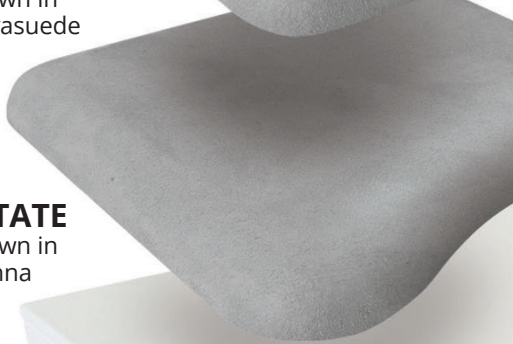

**ESTATE**  
Shown in Vienna



**VANTAGE**  
Shown in Vienna

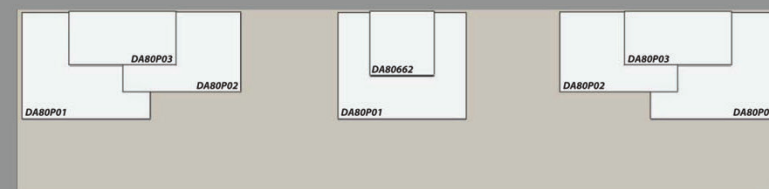
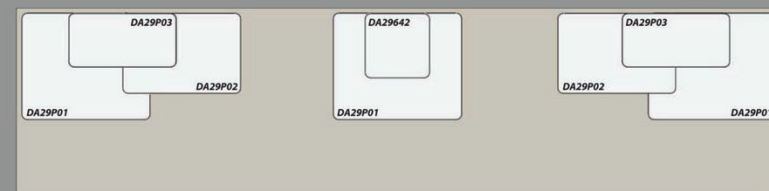
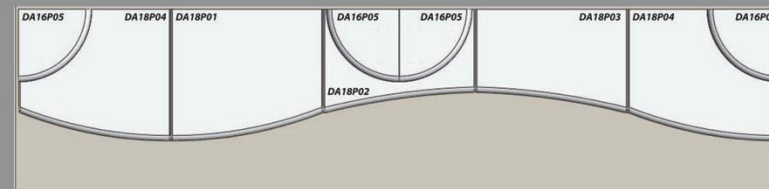
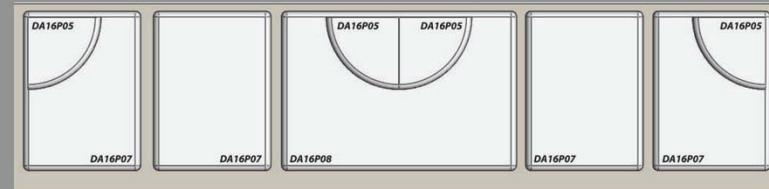
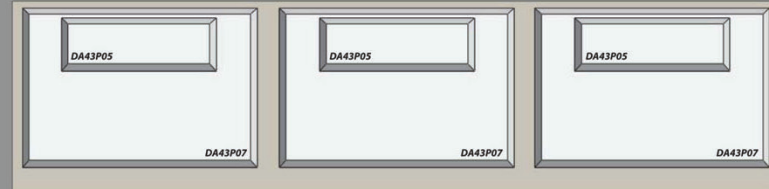

## ELEMENT AND SHOWCASE PLATFORM STYLES

Call our experts for assistance.

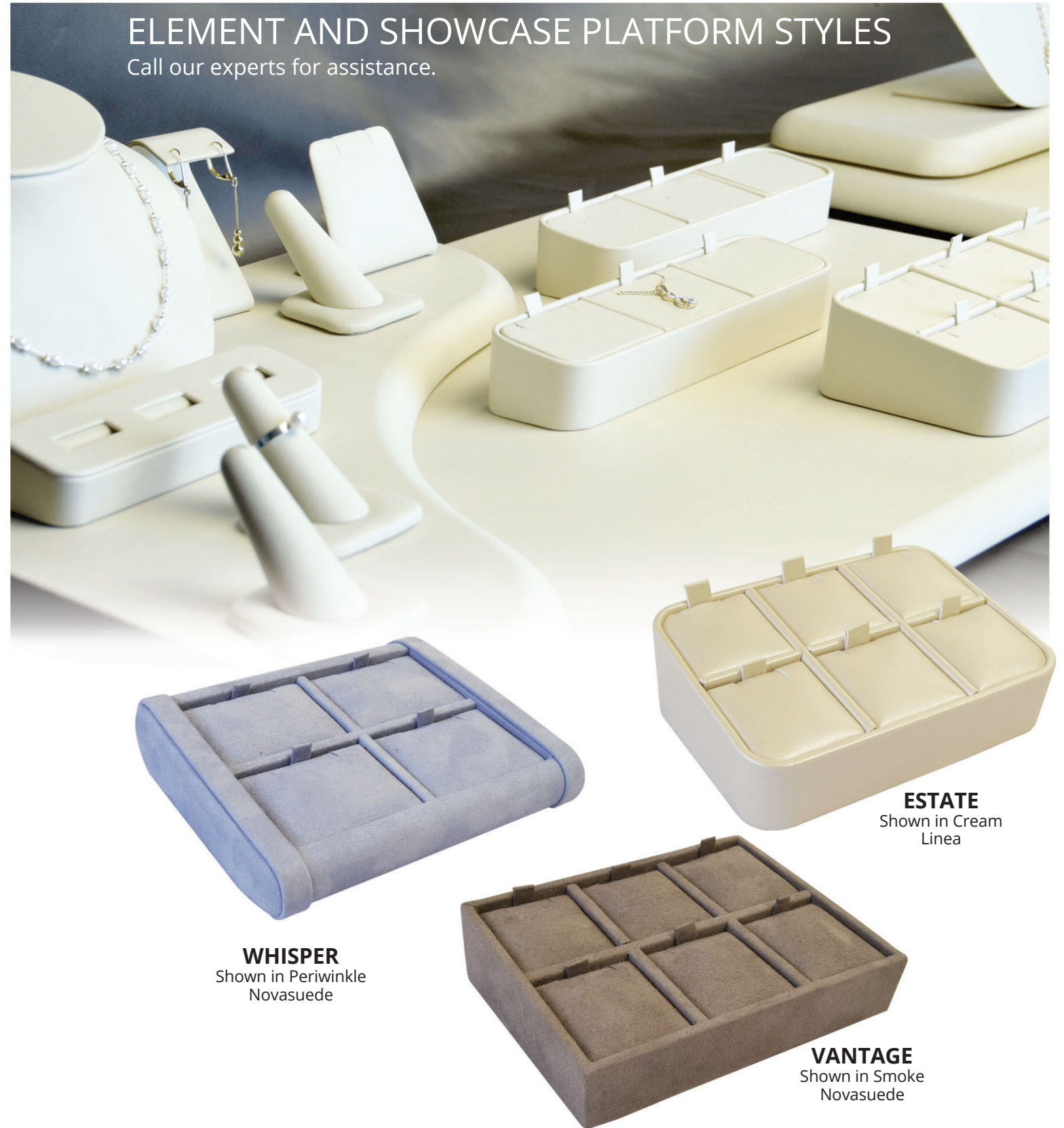

**WHISPER**  
Shown in Periwinkle  
Novasuede

**ESTATE**  
Shown in Cream  
Linea

**VANTAGE**  
Shown in Smoke  
Novasuede

JEWELRY DISPLAY

# CREATE YOUR OWN LOOK

## FABRICS & COLOR CHOICES

CALL OUR EXPERTS FOR ASSISTANCE.

### Fabric for Floorboards - Minimum order of 2 yards x 54" wide Cut Yardage Pricing

54"	Vienna	FIF1007936	\$57.20/yard
54"	Linea	FIF1037700	\$67.10/yard
49"	Charisma	FIF1037722	\$75.90/yard
54"	Elite	FIF1037723	\$75.90/yard
54"	Nova	FIF1037724	\$123.20/yard

Cutting Charge:  
\$70.00 for any order  
under 10 yards.

Lead times 2 - 3 weeks.

# CREATE YOUR OWN LOOK

**Step 3:** Choose your fabric color and style. Options: metal or wood details.



Elements shown  
in Black Vienna  
Leatherette

**Vienna Leatherette - Group A**

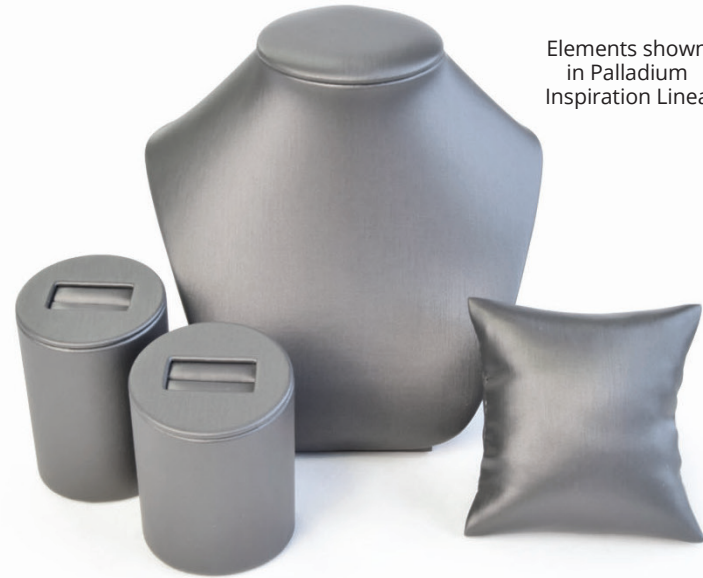

Elements shown  
in Palladium  
Inspiration Linea

**Inspirations Linea - Group B**

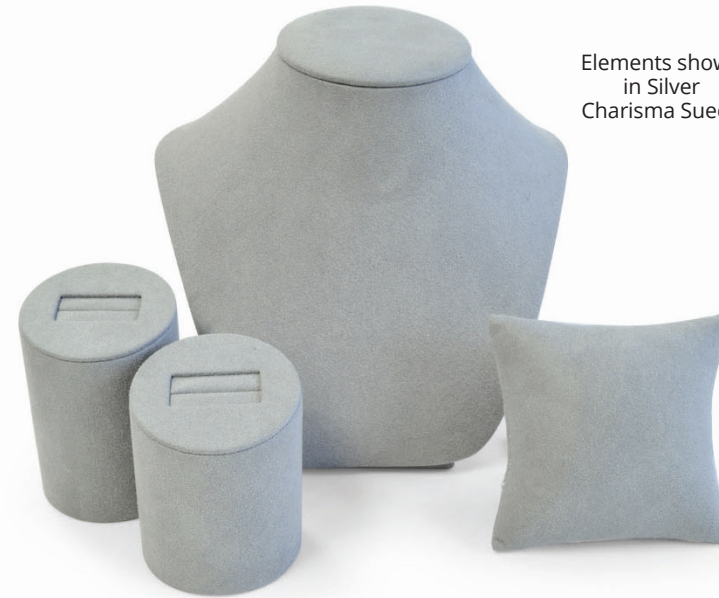

Elements shown  
in Silver  
Charisma Suede

**Charisma Suede - Group C**



Elements shown  
in Gainsborough  
Novasuede

**Novasuede - Group C**



Chalk Frost Pistachio



Moon Glow Paradiso Pecan Shell



Jade Blue Topaz Mink



Smoke Stone Grey Powder Grey



Mocha Metallic Bronze Copper



Classic Bronze Caponata Sepia



Taupe Silver Butternut



Taupe Beige Buttercup



Black Aubergine Port



Phantom Palladium Carbon



Palomino Fawn Buff



Periwinkle Sky Blue Blue Max

# IN STOCK

All our in stock displays are covered in Vienna Chalk fabric.

## Ring Showcase Displays

Available for immediate shipment.

Save 25% when you buy \$500 or more!

All our in stock displays are covered in Vienna Chalk fabric.

Available for immediate shipment.

# IN STOCK

## Pendant/Earring and Mix Showcase Displays

Save 25% when you buy \$500 or more!

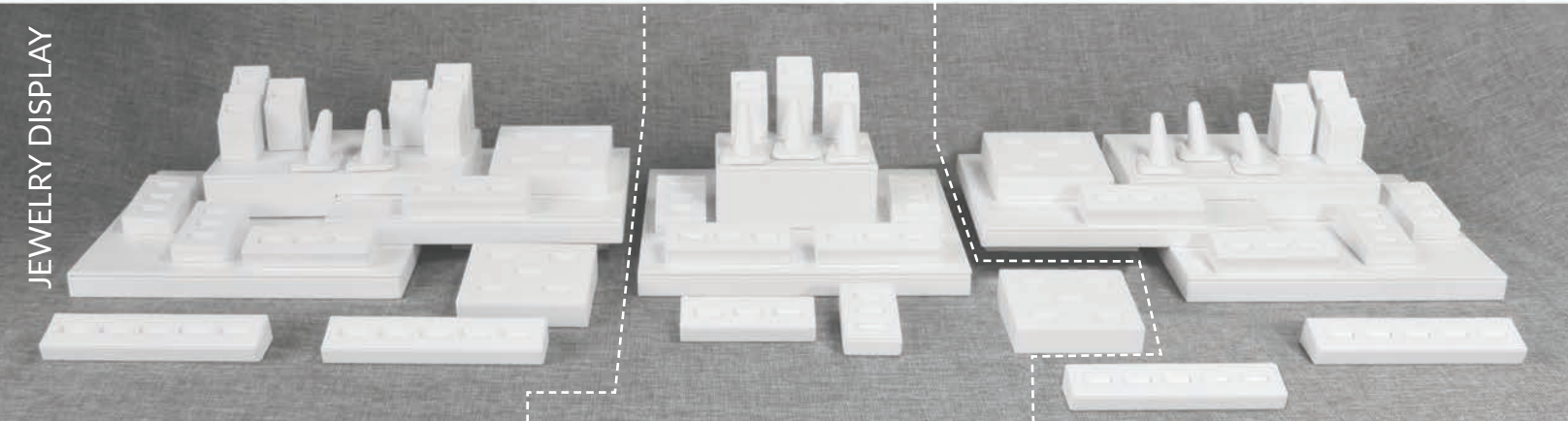

### Section 1

16 sku capacity - 40 Rings

**\$217.79\***

\*Platforms not included

### Section 2

12 sku capacity - 29 Rings

**\$188.58\***

\*Platforms not included

### Section 3

14 sku capacity - 33 Rings

**\$171.56\***

\*Platforms not included

Complete 6 foot - 102 ring element display - \$577.93 **Buy \$500+ \$433.45**

Add all platforms as shown - \$330.42 **Buy \$500+ \$247.82**

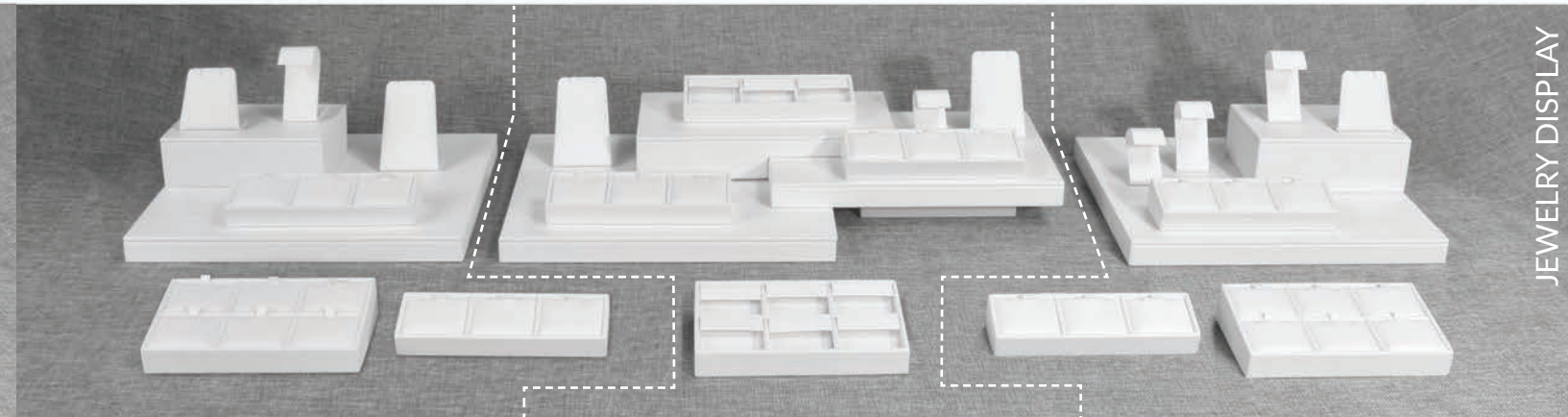

### Section 1

15 sku capacity - 5 Pendants, 10 Earrings

**\$107.57\***

\*Platforms not included

### Section 2

18 sku capacity - 5 Pendants, 13 Earrings

**\$94.44\***

\*Platforms not included

### Section 3

16 sku capacity - 13 Pendants, 3 Earrings

**\$95.85\***

\*Platforms not included

Complete 5 foot - 49 pendant/earring element display - \$297.86 **Buy \$500+ \$223.38**

Add all platforms as shown - \$273.15 **Buy \$500+ \$204.86**

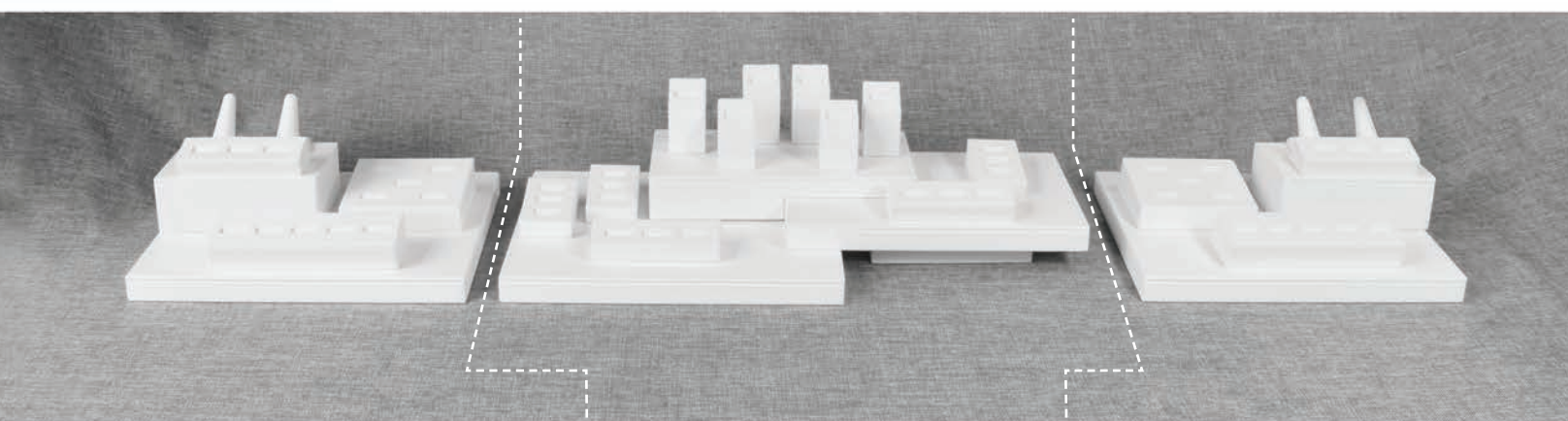

### Section 1

5 sku capacity - 15 Rings

**\$72.48\***

\*Platforms not included

### Section 2

11 sku capacity - 21 Rings

**\$118.15\***

\*Platforms not included

### Section 3

5 sku capacity - 15 Rings

**\$72.48\***

\*Platforms not included

Complete 5 foot - 51 ring element display - \$263.11 **Buy \$500+ \$197.59**

Add all platforms as shown - \$273.15 **Buy \$500+ \$204.86**

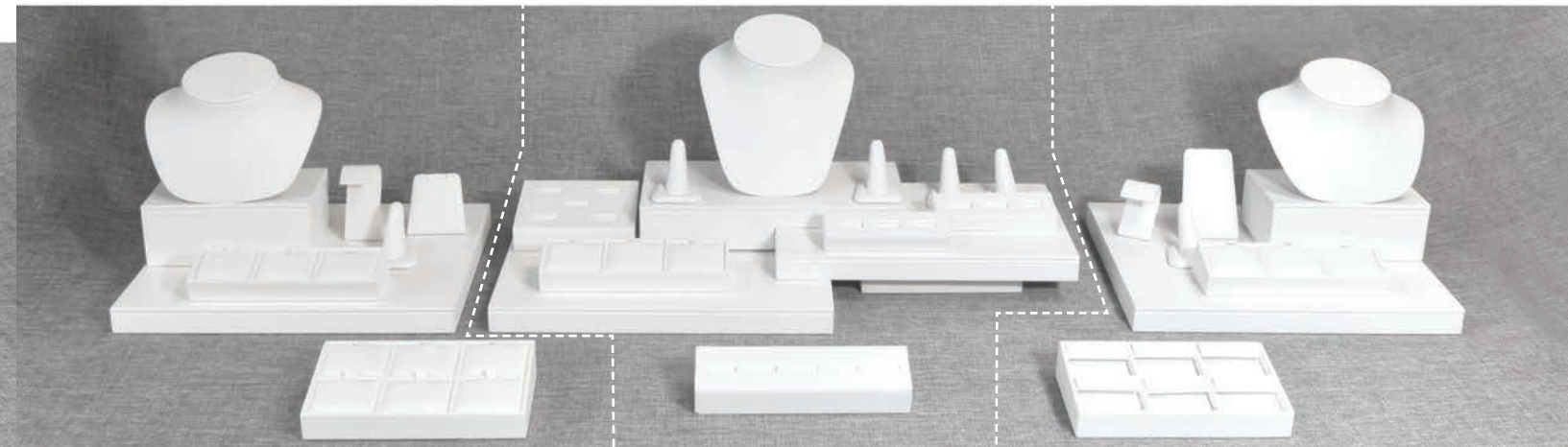

### Section 1

13 sku capacity - 1 Ring, 8 Pendants, 4 Earrings

**\$101.83\***

\*Platforms not included

### Section 2

24 sku capacity - 20 Rings, 4 Pendants

**\$171.10\***

\*Platforms not included

### Section 3

13 sku capacity - 1 Ring, 2 Pendants, 10 Earrings

**\$111.34\***

\*Platforms not included

Complete 5 foot - 50 mix element display - \$384.26 **Buy \$500+ \$288.20**

Add all platforms as shown - \$273.15 **Buy \$500+ \$204.86**





# IN STOCK

All our in stock displays are covered in Vienna Chalk fabric.

## Platforms and Risers

Available for immediate shipment.

Save 25% when you buy \$500 or more!

Item	Part No. / Description	Price/ea.	Item	Part No. / Description	Price/ea.
	<b>DA80P01-SC</b> Platform 12 x 10 x .875"	\$43.29		<b>DA80P03-SC</b> Platform 10 x 5 x 1.75"	\$41.35
	<b>BUY \$500+</b>	<b>\$32.47</b>		<b>BUY \$500+</b>	<b>\$31.01</b>
	<b>DA80P02-SC</b> Platform 11 x 7.5 x 1.875"	\$44.59		<b>DA80332-SC</b> Riser 3 x 3 x 2"	\$12.01
	<b>BUY \$500+</b>	<b>\$33.44</b>		<b>BUY \$500+</b>	<b>\$9.01</b>
	<b>DA80662-SC</b> Riser 6 x 6 x 2"	\$28.67			
	<b>BUY \$500+</b>	<b>\$21.50</b>			

\* Display case floorboards are not included in the price. Material for covering your own floorboards is available and is priced by the yard. See page 65.

### Platform layout suggestions



4 foot case - 26" wide, 10" deep



5 foot case - 44" wide, 10" deep



6 foot case - 52" wide, 10" deep • 19" left, 12" center and 19" right

Total price does not include applicable taxes. In stock displays and platforms are only available in VANTAGE style in Vienna fabric option.









# IN STOCK

## Neck Forms

All our in stock displays are covered in Vienna Chalk fabric.



Save 25% when you buy \$500 or more!

Item	Part No. / Description	Price/ea.	Item	Part No. / Description	Price/ea.
	<b>DANF1021-SC</b> Neck form 7.125 x 2.25 x 8.625"	\$43.07		<b>DANF1010-SC</b> Neck form 7.75 x 8.5 x 11"	\$69.54
	<b>BUY \$500+</b>	<b>\$32.30</b>		<b>BUY \$500+</b>	<b>\$52.16</b>
	<b>DANF1026-SC</b> Neck form 6 1/2 x 4 1/2 x 4"	\$25.96		<b>DANF1029-SC</b> Neck form 7 x 6 1/2 x 7 1/4"	\$46.80
	<b>BUY \$500+</b>	<b>\$19.47</b>		<b>BUY \$500+</b>	<b>\$35.10</b>
	<b>DANF1028-SC</b> Neck form 6 1/2 x 4 1/2 x 6"	\$43.78		<b>DANF2003-SC</b> Neck form 3 x 2 1/2 x 3 1/2"	\$18.00
	<b>BUY \$500+</b>	<b>\$32.83</b>		<b>BUY \$500+</b>	<b>\$13.50</b>
	<b>DANF1027-SC</b> Neck form 7 x 6 1/2 x 4 3/4"	\$61.29		<b>DANF1034-SC</b> Neck form 6 3/4 x 6 x 7 5/8"	\$49.78
	<b>BUY \$500+</b>	<b>\$45.97</b>		<b>BUY \$500+</b>	<b>\$37.34</b>

# IN STOCK

All our in stock displays are covered in Vienna Chalk fabric.

## Ring Stands and Trays

Available for immediate shipment.

Save 25% when you buy \$500 or more!

JEWELRY DISPLAY

Item	Part No. / Description	Price/ea.	Item	Part No. / Description	Price/ea.
	<b>DA80058UR-SC</b> Ring stand 1 5/8 x 1 1/2 x 2 1/8"	\$9.92 <b>BUY \$500+ \$7.44</b>		<b>DA80070S-SC</b> Ring stand set	\$48.78 <b>BUY \$500+ \$36.59</b>
	<b>DA80059UR-SC</b> Ring stand 1 5/8 x 1 1/2 x 2 1/2"	\$10.01 <b>BUY \$500+ \$7.51</b>			
	<b>DA80060UR-SC</b> Ring stand 1 5/8 x 1 1/2 x 2 3/4"	\$10.13 <b>BUY \$500+ \$7.60</b>		<b>DA8004RV-SC</b> 4 ring vertical bar 1 3/4 x 4 x 1"	\$16.80 <b>BUY \$500+ \$12.60</b>
	<b>DA28A01UR-SC</b> Universal ring tray 2 3/8 x 2 1/4 x 1 1/2"	\$9.12 <b>BUY \$500+ \$6.84</b>		<b>DA8005RH-SC</b> 5 ring horizontal bar 7 1/4 x 1 5/8 x 1"	\$20.40 <b>BUY \$500+ \$15.30</b>
	<b>DA8002RV-SC</b> 2 ring vertical bar 1 3/4 x 2 1/8 x 1"	\$12.01 <b>BUY \$500+ \$9.01</b>		<b>DA28C05UR-SC</b> 5 universal ring tray 6 3/4 x 2 1/4 x 1 1/2"	\$18.00 <b>BUY \$500+ \$13.50</b>
	<b>DA8002RH-SC</b> 2 ring horizontal bar 3 1/4 x 1 5/8 x 1"	\$12.01 <b>BUY \$500+ \$9.01</b>		<b>DA28D05UR-SC</b> 5 universal ring tray 4 5/8 x 4 x 1 1/2"	\$24.00 <b>BUY \$500+ \$18.00</b>
	<b>DA8003RV-SC</b> 3 ring vertical bar 1 3/4 x 3 x 1"	\$14.00 <b>BUY \$500+ \$10.50</b>		<b>DA28E05RD-SC</b> 5 ring duo tray 6 3/4 x 4 x 1 1/2"	\$28.41 <b>BUY \$500+ \$21.31</b>
	<b>DA8003RH-SC</b> 3 ring horizontal bar 4 1/2 x 1 5/8 x 1"	\$15.02 <b>BUY \$500+ \$11.27</b>		<b>DA28E07UR-SC</b> 7 ring tray 6 3/4 x 4 x 1 1/2"	\$28.01 <b>BUY \$500+ \$21.01</b>

All our in stock displays are covered in Vienna Chalk fabric.

# IN STOCK

## Ring Stands, Pendant Stands and Trays

Available for immediate shipment.

Save 25% when you buy \$500 or more!

JEWELRY DISPLAY

Item	Part No. / Description	Price/ea.	Item	Part No. / Description	Price/ea.
	<b>DA28D07UR-SC</b> 7 universal ring tray 4 5/8 x 4 x 1 1/2"	\$28.11 <b>BUY \$500+ \$21.08</b>		<b>DAF400T-SC</b> Ring feature stand 2 5/8 x 2 1/4 x 2.625"	\$20.00 <b>BUY \$500+ \$15.00</b>
	<b>DA28E08UR-SC</b> 8 ring tray 6 3/4 x 4 x 1 1/2"	\$27.20 <b>BUY \$500+ \$20.40</b>		<b>DAF400S-SC</b> Ring feature stand 2 5/8 x 2 1/4 x 2.25"	\$19.60 <b>BUY \$500+ \$14.70</b>
	<b>DA28D08UR-SC</b> 8 universal ring tray 4 5/8 x 4 x 1 1/2"	\$25.38 <b>BUY \$500+ \$19.04</b>		<b>DARF110-SC</b> Ring finger 2 7/8 x 2 5/8 x 1 7/8"	\$7.82 <b>BUY \$500+ \$5.87</b>
	<b>DA28E11UR-SC</b> 11 ring tray 6 3/4 x 4 x 1 1/2"	\$27.20 <b>BUY \$500+ \$20.40</b>		<b>DARD130-SC</b> Ring disc min. order qty. of 12 1 1/4" Diameter	\$0.76 <b>BUY \$500+ \$0.57</b>
Item	Part No. / Description	Price/ea.	Item	Part No. / Description	Price/ea.
	<b>DA350P-SC</b> Pendant stand 2 3/8 x 1 1/2 x 3 1/2"	\$10.01 <b>BUY \$500+ \$7.51</b>		<b>DA225P-SC</b> Pendant stand 2 3/8 x 2 1/4 x 2"	\$8.01 <b>BUY \$500+ \$6.01</b>
	<b>DA345P-SC</b> Pendant stand 3 x 2 x 4"	\$18.67 <b>BUY \$500+ \$14.00</b>		<b>DA234P-SC</b> Pendant stand 2 1/2 x 2 x 3"	\$12.01 <b>BUY \$500+ \$9.01</b>
	<b>DA28A01PD-SC</b> Pendant tray 2 3/8 x 2 1/4 x 1 1/2"	\$10.41 <b>BUY \$500+ \$7.81</b>		<b>DA28C03PD-SC</b> 3 pendant tray 6 3/4 x 2 1/4 x 1 1/2"	\$24.00 <b>BUY \$500+ \$18.00</b>
	<b>DA28D04PD-SC</b> 4 pendant tray 4 5/8 x 4 x 1 1/2"	\$31.61 <b>BUY \$500+ \$23.71</b>		<b>DA28D06PD-SC</b> 6 pendant tray 4 5/8 x 4 x 1 1/2"	\$34.01 <b>BUY \$500+ \$25.51</b>
	<b>DA28E06PD-SC</b> 6 pendant tray 6 3/4 x 4 x 1 1/2"	\$34.01 <b>BUY \$500+ \$25.51</b>		<b>DA28E08PD-SC</b> 8 pendant tray 6 3/4 x 4 x 1 1/2"	\$38.01 <b>BUY \$500+ \$28.51</b>

# IN STOCK

## Earring Stands and Trays

Save 25% when you buy \$500 or more!

Available for immediate shipment.

All our in stock displays are covered in Vienna Chalk fabric.

Item	Part No. / Description	Price/ea.	Item	Part No. / Description	Price/ea.
	<b>DACES14-SC</b> Earring tree stand 2 x 2 x 3"	\$11.26 <b>BUY \$500+ \$8.45</b>		<b>DACES13-SC</b> Earring stand 1 1/4 x 1 7/8 x 2 3/4"	\$9.94 <b>BUY \$500+ \$7.46</b>
	<b>DACES36-SC</b> Earring stand 2 3/4 x 1 3/4 x 3 1/2"	\$11.26 <b>BUY \$500+ \$8.45</b>		<b>DASLD6-SC</b> Earring sled 2 x 8 1/4 x 2"	\$12.01 <b>BUY \$500+ \$9.01</b>
	<b>DA28A01FE-SC</b> Flap earring tray 2 3/8 x 2 1/4 x 1 1/2"	\$12.01 <b>BUY \$500+ \$9.01</b>		<b>DA28A01PE-SC</b> Pierced earring tray 2 3/8 x 2 1/4 x 1 1/2"	\$10.31 <b>BUY \$500+ \$7.73</b>
	<b>DA28C03FE-SC</b> 3 flap earring tray 6 3/4 x 2 1/4 x 1 1/2"	\$20.00 <b>BUY \$500+ \$15.00</b>		<b>DA28C03PE-SC</b> 3 pierced tray 6 3/4 x 2 1/4 x 1 1/2"	\$21.60 <b>BUY \$500+ \$16.20</b>
	<b>DA28D04FE-SC</b> 4 flap earring tray 4 5/8 x 4 x 1 1/2"	\$31.61 <b>BUY \$500+ \$23.71</b>		<b>DA28D04PE-SC</b> 4 pierced earring tray 4 5/8 x 4 x 1 1/2"	\$27.78 <b>BUY \$500+ \$20.83</b>
	<b>DA28D06FE-SC</b> 6 flap earring tray 4 5/8 x 4 x 1 1/2"	\$36.01 <b>BUY \$500+ \$27.01</b>		<b>DA28D06PE-SC</b> 6 pierced earring tray 4 5/8 x 4 x 1 1/2"	\$39.00 <b>BUY \$500+ \$29.25</b>
	<b>DA28E06FE-SC</b> 6 flap earring tray 6 3/4 x 4 x 1 1/2"	\$36.01 <b>BUY \$500+ \$27.01</b>		<b>DA28E06PE-SC</b> 6 pierced earring tray 6 3/4 x 4 x 1 1/2"	\$34.01 <b>BUY \$500+ \$25.51</b>
	<b>DA28E08FE-SC</b> 8 flap earring tray 6 3/4 x 4 x 1 1/2"	\$43.39 <b>BUY \$500+ \$32.54</b>		<b>DA28E08PE-SC</b> 8 pierced earring tray 6 3/4 x 4 x 1 1/2"	\$34.01 <b>BUY \$500+ \$25.51</b>

All our in stock displays are covered in Vienna Chalk fabric.

# IN STOCK

## Earring, Bangle and Bracelet Stands, Chain Ramps, Counter Pads and Signage

Available for immediate shipment.

Save 25% when you buy \$500 or more!

Item	Part No. / Description	Price/ea.	Item	Part No. / Description	Price/ea.
	<b>05000755</b> Earring stand 7 x 4 1/2 x 1 3/4"	\$31.83 <b>BUY \$500+ \$23.87</b>		<b>DABS185-SC</b> Bracelet sled 1 1/4 x 9 1/4 x 1 3/4"	\$9.88 <b>BUY \$500+ \$7.41</b>
	<b>DASBS12-SC</b> Bangle "T" bar 7 1/8 x 2 3/4 x 5 1/4" (dia. 1.625")	\$31.90 <b>BUY \$500+ \$23.93</b>		<b>DABS485-SC</b> Bracelet sled 4 x 9 5/8 x 1 7/8"	\$17.07 <b>BUY \$500+ \$12.80</b>
	<b>DAJP350V-SC</b> Bracelet pillow w/stand 3 1/4 x 3 1/4 x 3 1/4"	\$11.13 <b>BUY \$500+ \$8.35</b>		<b>DADB425-SC</b> Bracelet dome 4 1/8 x 5 1/8 x 2 1/2"	\$33.65 <b>BUY \$500+ \$25.24</b>
	<b>DACHR16-SC</b> Chain ramp / Rem. pad 10 1/4 x 16" chain pad 10 3/4 x 16 1/2 x 3 1/2"	\$120.08 <b>BUY \$500+ \$90.06</b>		<b>DA1081R-SC</b> Pres. tray w/ring 10 1/2 x 8 5/8 x 1"	\$51.12 <b>BUY \$500+ \$38.34</b>
	<b>New</b> <b>05000845-SC</b> 16 Chain Tray Stackable 8 5/8 x 13 3/4 x 1 1/2"	\$130.26 <b>BUY \$500+ \$97.70</b>		<b>DAPCF5510-SC</b> Counter pad plain 5 1/4 x 10 1/4 x 3/4" closed 10 3/4 x 10 1/4 x 3/8" open	\$34.24 <b>BUY \$500+ \$25.68</b>
	<b>DACW884-SC</b> Chain display wedge 8 x 8 x 3 3/4"	\$51.61 <b>BUY \$500+ \$38.71</b>			
				<b>DASB211</b> Sign stand 2 3/4 x 2 3/16 x 1 1/4"	\$10.13 <b>BUY \$500+ \$7.60</b>

# IN STOCK

All our in stock displays are covered in Vienna Chalk fabric.

## Specialty Items

Available for immediate shipment.

Save 25% when you buy \$500 or more!

JEWELRY DISPLAY

Item	Part No. / Description	Price/ea.	Item	Part No. / Description	Price/ea.
	<b>05000300-SC</b> Loose Diamond Arch 11.5" x 4" x 1.5"	\$74.55 <b>BUY \$500+ \$55.91</b>		<b>05000301</b> Diamond Cup 1.125" diameter x .75"	\$11.33 <b>BUY \$500+ \$8.50</b>
	<b>05000299-SC</b> Pearl Half Moon 8" x 8" x 3.25"	\$95.81 <b>BUY \$500+ \$71.86</b>		<b>05000298-SC</b> Wave Chain Ramp 10.125" x 9" x 2.625"	\$88.91 <b>BUY \$500+ \$66.68</b>
	Sign size: 3.9375" x 2.375" <b>05000300</b> Acrylic Sign 1.1875" x 4" x 2.75"	\$15.31 <b>BUY \$500+ \$11.48</b>		<b>05000302</b> Bevelled Edge Mirror 8.5" x 8.25" x 5.5"	\$55.04 <b>BUY \$500+ \$41.28</b>
	<b>05000581-SC</b> Pendant/earring tray with PVC signage 4.75" x 9.5" x 2"	\$46.28 <b>BUY \$500+ \$34.71</b>		<b>36301103</b> Small Vision Box 2.68 x 2.68 x .75"	\$1.00
				<b>36302103</b> Medium Vision Box 3.5 x 3.5 x .75"	\$1.33
				<b>36303103</b> Large Vision Box 4.25 x 4.25 x .75"	\$1.66
				<b>69300103</b> Base for Vision Box 2.24 x 2.24 x .62" Bag of 12	\$0.83

# JEWELRY STORAGE by MELE AND Co



# IN STOCK

Visit [Melejewelrybox.com](http://Melejewelrybox.com) for order information.

Jewelry Storage by **MELE AND Co**



## THE STOWAWAY LINE

- Vegan leather with coordinating zipper pull
- Cream anti-tarnish microsuede interior lining and metal zipper closure
- Custom leather option upon request
- Branded cleaning cloth and reusable dust bag included



The Essentials Colour Line

Black - 62    Buff - 44    Ecru - 10

Code	Description	Size (inches)	Pack	Black - 62	Buff - 44	Ecru - 10
A 00629__	Bento	7 x 6.25 x 3.125	2	✓	✓	—
B 00518__	Duo	6.875 x 3 x 5.25	2	✓	✓	—
C 00513__	Duo Mini	5 x 3.75 x 2	4	✓	✓	✓
D 00626__	Stow and Go	5 x 5 x 2.25	2	✓	✓	✓
E 00618__	Stow and Go Mini	3.5 (D) x 1.625	4	✓	✓	✓

Visit [melejewelrybox.com](http://melejewelrybox.com) for these plus other fashion forward, timeless classics and youthful collections!



Everly    Kate    Kelby    Geneva    Olympia    Grant

# BAGS

EUROTOTES, PAPER, POLY & REUSABLE



# IN STOCK

## Rope Handle Eurototes

BAGS



Vantage II Eurototes  
Available Colors



### Vantage II Eurototes

- 150 gsm uncoated art paper
- 5 mm pp cord knotted handles
- Folded top turn and cardboard reinforced bottom
- Minimum order is 100 per color per size

CODE	SIZE (inches)	PRICE/EACH		
		100+	500+	1000+
A 230606 ___	6 x 3.5 x 6 x 3.5	\$1.00	\$0.92	\$0.79
B 231008 ___	10.5 x 5 x 8.5 x 5	\$1.27	\$1.14	\$0.98

Estimated lead time: 2 - 3 weeks for printed items from approved art.



**FOIL PRINT**  
100+ 35¢ each  
1000+ 32¢ each  
2500+ 26¢ each

Eclipse and Geo Eurototes  
Available Colors



### Eclipse and Geo Eurototes

- 150 gsm uncoated art paper
- 5 mm pp cord knotted handles
- Folded top turn and cardboard reinforced bottom
- Minimum order is 100 per color per size



# IN STOCK

## Rope Handle Eurototes

BAGS



### Laminated Eurotote with Rope Handle

- Matte lamination
- 157 gsm art paper
- 5 mm pp cord knotted polypropelene handle
- Folded top turn and cardboard reinforced bottom
- Minimum order is 100 per color per size

CODE	TYPE	SIZE (inches)	PRICE/EACH		
			100+	500+	1000+
A 239606 __	Novelty	6 x 3.5 x 6 x 3.5	\$0.88	\$0.77	\$0.74
B 239709 __	Small gift	9 x 3.5 x 7 x 3.5	\$1.03	\$0.90	\$0.85
C 239810 __	Gift	8 x 4 x 10 x 4	\$1.10	\$1.00	\$0.91
D 230908 __T	Trapezoid	9/7 x 4 x 8.5 x 4	\$1.23	\$1.08	\$1.04
E 238116 __	Fashion	16 x 6 x 12 x 6	\$1.94	\$1.70	\$1.64
F 231011 __	Watch	10 x 5 x 11 x 5	\$1.24	\$1.05	\$1.00

Estimated lead time: 2 - 3 weeks for printed items from approved art.



**DIGITAL PRINT**  
100+ \$2.15 each  
1000+ \$1.99 each  
300 bags minimum



**FOIL PRINT**  
100+ 35¢ each  
1000+ 32¢ each  
2500+ 26¢ each



	15-Black	00-White	07-Gold	08-Silver	42-Brown	11-Blue	10-Green
Novelty	✓	✓	✓	✓	✓	✓	✓
Small Gift	✓	✓	✓	✓	✓	✓	✓
Gift	✓	✓	✓	✓	✓	✓	✓
Trapezoid	✓	✓	✓	—	✓	—	—
Fashion	✓	✓	✓	✓	✓	—	—
Watch	✓	✓	✓	—	—	—	—

All print orders subject to set-up charges. Applicable artwork, and plate charges may apply. See page 122.

All print orders subject to set-up charges. Applicable artwork, and plate charges may apply. See page 122.

# IN STOCK

## Luxury Grosgrain Handle Eurototes

# IN STOCK

## All Paper Eurototes

BAGS

BAGS



### Luxury Grosgrain Handle Eurototes

- Gloss and matte lamination
- 157 gsm art paper
- 7/8" matching grosgrain, knotted handles
- Fold over top turn and cardboard reinforced bottom
- Minimum order is 100 per color per size

CODE	SIZE (inches)	CASE PACK	PRICE/EACH		
			100+	500+	1000+
A 230606	6 x 3 x 6 x 3	100	\$0.94	\$0.84	\$0.73
B 230810	8 x 4 x 10 x 4	100	\$0.99	\$0.89	\$0.76
C 231209	12.5 x 4.5 x 9 x 4.5	100	\$1.19	\$1.07	\$0.92
D 231612	16 x 6 x 12 x 6	100	\$1.61	\$1.45	\$1.25
E 232014	20 x 6 x 14 x 6	100	\$1.81	\$1.63	\$1.40

\* champagne and pewter not available in this size.

### All Paper Eurotote with Paper Rope Handle

- 100% recyclable
- 40% post-consumer waste
- 190 gsm uncoated paper
- 8 mm paper cord knotted handles
- Folded top turn and cardboard reinforced bottom
- Minimum order is 100 per color per size

CODE	SIZE (inches)	CASE PACK	PRICE/EACH		
			100+	500+	1000+
A 230606	6 x 3.5 x 6 x 3.5	100	\$0.76	\$0.69	\$0.58
B 230810	8 x 4 x 10 x 4	100	\$0.83	\$0.77	\$0.65
C 231013	10 x 5 x 13 x 5	100	\$0.94	\$0.85	\$0.72
D 231612	16 x 6 x 12 x 6	100	\$1.42	\$1.29	\$1.10



Available Colors



15BM Black Matte    15BG Black Gloss    02C Champagne    08P Pewter    00W White

Estimated lead time: 2 - 3 weeks for printed items from approved art.

**DIGITAL PRINT**  
 100+ \$2.15 each  
 1000+ \$1.99 each  
 300 bags minimum

**FOIL PRINT**  
 100+ 35¢ each  
 1000+ 32¢ each  
 2500+ 26¢ each

Available Colors



75AK Kraft    00AW White    15AB Black    28AC Cream

Estimated lead time: 2 - 3 weeks for printed items from approved art.

**FOIL PRINT**  
 100+ 35¢ each  
 1000+ 32¢ each  
 2500+ 26¢ each

All print orders subject to set-up charges. Applicable artwork, and plate charges may apply. See page 122.

All print orders subject to set-up charges. Applicable artwork, and plate charges may apply. See page 122.

# CREATE YOUR OWN LOOK

## Full Color Paper Eurototes

Make a creative impression...  
the combinations are endless!



Prices include up to 2 ink print colors:

TYPE	SIZE (inches)
Novelty	6 x 3.5 x 6 x 3.5
Small Gift	9 x 3.5 x 7 x 3.5
Gift	8 x 4 x 10 x 4
Trapezoid	9/7 x 4 x 8.5 x 4
Wine	3.375 x 3.5 x 13 x 3.5
Fashion	16 x 6 x 12 x 6
Saville	16 x 6 x 19 x 6

Prices include 4 color process print:

TYPE	SIZE (inches)
Novelty	6 x 3.5 x 6 x 3.5
Small Gift	9 x 3.5 x 7 x 3.5
Gift	8 x 4 x 10 x 4
Trapezoid	9/7 x 4 x 8.5 x 4
Wine	3.375 x 3.5 x 13 x 3.5
Fashion	16 x 6 x 12 x 6
Saville	16 x 6 x 19 x 6

- Combination foil print and ink printing available.
- No charge for printing plates (proof charge applies)
- Substitute a satin ribbon handle for the standard rope
- Add metal grommets to your bag



Unique printing options available.  
Double Stamping shown here.

Estimated lead time: 14 - 16 weeks for delivery from approved art.



**Create Your Own Look:**  
Choose your bag style.  
Send us your artwork.  
For 100% full color design, speak to your sales representative.

# SPECIAL ORDER

## 5th Avenue Eurototes



Thick Woven Handle Detail



## 5th Avenue Eurototes

- Embossed laminated finish with printed gloss coordinating color interior
- 210 gsm
- Thick woven handles, top slit style
- W fold & removable bottom board
- Minimum order is 100 per color per size

CODE	SIZE (inches)	CASE PACK	PRICE/EACH	
			100+	1000+
A 245820 __	8 x 3.5 x 6 x 3.5	100	\$2.63	\$2.63
B 245821 __	12.5 x 4.5 x 9 x 4.5	100	\$4.17	\$4.17
C 245822 ___	17 x 6 x 12.75 x 6	100	\$5.70	\$5.70

Estimated lead time: 3 - 5 weeks for printed items from approved art.

**DIGITAL PRINT**  
100+ \$2.15 each  
1000+ \$1.99 each  
300 bags minimum

**FOIL PRINT**  
100+ 35¢ each  
1000+ 32¢ each  
2500+ 26¢ each

Available Colors



# SPECIAL ORDER

# SPECIAL ORDER

## Paper Shoppers

BAGS

BAGS



12" Wide Gussets!



## Manhattan Eurototes

- Uncoated paper with varnish finish\*
- 180 gsm wood-free paper
- 5/8" poly/cotton twill knotted handle
- Folded top turn and cardboard reinforced bottom
- 200 gsm kraft paper 75% recycled\*\* (color chart reference)

CODE	TYPE	CASE	PRICE/EACH		
			100+	500+	1000+
A 245845 __	Mini	100	\$0.97	\$0.97	\$0.97
B 245841 __	Petite	100	\$1.22	\$1.22	\$1.22
C 245843 __	Vanity	100	\$1.54	\$1.54	\$1.54
D 245844 __	Fashion	100	\$2.12	\$2.12	\$2.12
E 245860 __	X-Large	50	\$3.27	\$3.27	\$3.27
F 245898 __	Bottle Bag	100	\$1.34	\$1.34	\$1.34

WIDE GUSSET EUROTOTES			PRICE/EACH		
CODE	TYPE	CASE	100+	500+	1000+
24585615	Medium - Black	100	\$4.36	\$4.36	\$4.36
24585715	Large - Black	100	\$4.87	\$4.87	\$4.87
24585600	Medium - White	100	\$4.36	\$4.36	\$4.36
24585700	Large - White	100	\$4.87	\$4.87	\$4.87
24585675	Medium - Kraft	100	\$4.36	\$4.36	\$4.36
24585775	Large - Kraft	100	\$4.87	\$4.87	\$4.87



Size	15* Black	00* White	75** Kraft	08* Grey	09* Red	41* Fuchsia	11** Navy
Mini 5 x 4 x 6 x 4 in	✓	✓	✓	✓	✓	✓	✓
Petite 8 x 4 x 10 x 4 in	✓	✓	✓	✓	✓	✓	✓
Vanity 10 x 5 x 13 x 5 in	✓	✓	✓	✓	✓	✓	✓
Fashion 16 x 6 x 12 x 6 in	✓	✓	✓	✓	✓	✓	✓
X-Large 20 x 6 x 14 x 6 in	✓	✓	✓	—	—	—	—
Bottle 4.5 x 4.5 x 15 x 4.5 in	✓	✓	✓	—	✓	—	—
Wide Gusset Medium 12.5 x 12 x 12 x 12 in.	✓	✓	✓	—	—	—	—
Wide Gusset Large 16 x 12 x 11 x 12 in.	✓	✓	✓	—	—	—	—

Estimated lead time: 3 - 5 weeks for printed items from approved art.

**DIGITAL PRINT**  
100+ \$2.15 each  
1000+ \$1.99 each  
300 bags minimum

**FOIL PRINT**  
100+ 35¢ each  
1000+ 32¢ each  
2500+ 26¢ each



New



## Totally Trim Paper Shoppers

- Twist paper handle with bottom gusset
- 100% recyclable and biodegradable
- Minimum order per color per size



CODE	DESCRIPTION	SIZE (inches)	CASE PACK	PRICE/EACH	
				300+	1000+
245111 __	Small (90 gsm)	11.8 x 9.8 x 3.9	300	\$0.55	\$0.49
245114 __	Medium (100 gsm)	14.2 x 10.6 x 3.9	250	\$0.62	\$0.53
245118 __	Large (100 gsm)	18.1 x 12.4 x 5.9	300	\$0.75	\$0.75
245119 __	Extra Large (100 gsm)	19.7 x 16.3 x 5.9	250	\$0.88	\$0.88

**DIGITAL PRINT**  
100+ \$2.15 each  
1000+ \$1.99 each  
300 bags minimum

**INK PRINT**  
100+ 34¢ each  
1000+ 29¢ each  
2500+ 24¢ each

**FOIL PRINT**  
100+ 35¢ each  
1000+ 32¢ each  
2500+ 26¢ each

Estimated lead time: 2 - 3 weeks for printed items from approved art.



## Tints and Pinstripe on Kraft

- Twist paper handle
- 120 gsm paper



Pinstripe Detail

Tints on Kraft



Pinstripe on Kraft



CODE	DESCRIPTION	SIZE (inches)	CASE PACK	PRICE/EACH
230508 ____	Prime	5 x 3 x 8 x 3	250	\$0.85
230809 ____	Petite	8 x 4.5 x 10	250	\$0.87
231611 ____	Fashion	16 x 6 x 12 x 6	250	\$1.38

**DIGITAL PRINT**  
250+ \$2.15 each  
1000+ \$1.99 each  
300 bags minimum

**INK PRINT**  
250+ 34¢ each  
1000+ 29¢ each  
2500+ 24¢ each

**FOIL PRINT**  
250+ 35¢ each  
1000+ 32¢ each  
2500+ 26¢ each

Estimated lead time:  
Aprox. 6 weeks for No Print Bags.  
Aprox 8 - 10 weeks for Printed items from approved art.

All print orders subject to set-up charges. Applicable artwork, and plate charges may apply. See page 122.

All print orders subject to set-up charges. Applicable artwork, and plate charges may apply. See page 122.

# CREATE YOUR OWN LOOK

## Full Color Simply Paper Shoppers

Make a creative impression...  
the combinations are endless!



### Simply Paper Shoppers

**Kraft with paper twist handles, print 1 color on 2 sides <25%**

TYPE	SIZE (inches)	CASE PACK
Prime	5.25 x 3.5 x 8.25	250
Petite	8 x 4 x 10	250
Vanity	10 x 5 x 13	250
Celebrity	13 x 6 x 15.5	250
Fashion	16 x 6 x 12	250
Saville	16 x 6 x 19	200
Universal	18 x 6 x 19	200
Wine	5.25 x 3.5 x 13	250

Any 2 Sizes  
Minimum 3000  
Special Pricing

**White with paper twist handles, print 1 color on 2 sides <25%**

TYPE	SIZE (inches)	CASE PACK
Prime	5.25 x 3.5 x 8.25	250
Petite	8 x 4 x 10	250
Vanity	10 x 5 x 13	250
Celebrity	13 x 6 x 15.5	250
Fashion	16 x 6 x 12	250
Saville	16 x 6 x 19	200
Universal	18 x 6 x 19	200
Wine	5.25 x 3.5 x 13	250

Any 2 Sizes  
Minimum 3000  
Special Pricing



**Create Your Own Look:**  
Choose your bag style.  
Send us your artwork.  
For 100% full color  
design, speak to your  
sales representative.



96% Recycled Material

• Minimum 5,000 per size or any  
2 sizes, minimum 3000 per size

• Add a second color

• Go 100% ink coverage

• Add a rope handle

Estimated lead time: 12 - 14  
weeks for printed items from  
approved art.



### Paper Twist Handle Shopping Bags

- 100% recyclable
- Kraft: 90% post-consumer waste/ White: 100% virgin paper
- 110 gsm paper (80 gsm for kraft and black)
- Minimum order is 250/200 per color per size

CODE	TYPE	SIZE (inches)	CASE	12 - Kraft PRICE/EACH		00 - White PRICE/EACH		Tints PRICE/EACH		Metallics PRICE/EACH	
				250+	1000+	250+	1000+	250+	1000+	250+	1000+
230508_*	Prime	5 x 3.5 x 8 x 3.5	250	\$0.33	\$0.28	\$0.41	\$0.33	\$0.59	\$0.50	\$0.64	\$0.54
230809_	Petite	8 x 4.5 x 10.75 x 4.5	250	\$0.38	\$0.33	\$0.41	\$0.36	\$0.61	\$0.55	\$0.67	\$0.60
230914_	Vanity	10 x 5 x 13 x 5	250	\$0.59	\$0.40	\$0.46	\$0.41	—	—	—	—
231315_	Celebrity	13 x 6 x 15 x 6	250	\$0.47	\$0.44	\$0.54	\$0.51	—	—	—	—
231611_	Fashion	16 x 6 x 12 x 6	250	\$0.46	\$0.44	\$0.51	\$0.46	\$0.60	\$0.53	\$1.01	\$0.92
231619_	Saville	16 x 6 x 19 x 6	**	\$0.59	\$0.51	\$0.69	\$0.60	\$0.81	\$0.74	\$1.50	\$1.39
231819_	Universal	18 x 7 x 18.75 x 7	200	\$0.62	\$0.55	\$0.67	\$0.83	—	—	—	—
230513_	Wine Shopper	5.25 x 3.5 x 13	250	\$0.68	\$0.64	\$0.73	\$0.69	—	—	—	—

Available Colors

	12- Kraft	00- White	35- Black	41- Navy	07- Gold	08- Silver
Prime	✓	✓	✓	✓	✓	✓
Petite	✓	✓	✓	✓	✓	✓
Vanity	✓	✓	—	—	—	—
Celebrity	✓	✓	—	—	—	—
Fashion	✓	✓	✓	✓	✓	✓
Saville	✓	✓	✓	✓	✓	✓
Universal	✓	✓	✓	✓	✓	✓
Wine	✓	✓	—	—	—	—

\* White and Kraft is 230508\_ \_P  
\* Black, Navy, Gold and Silver 230508\_ \_PR  
\*\* White and Kraft are sold in case packs of 200 and the Black, Navy, Gold and Silver are sold in case packs of 250

**Sturdy, durable.  
Our best value bags.**

**DIGITAL PRINT**  
100+ \$2.15 each  
1000+ \$1.99 each  
300 bags minimum

**FOIL PRINT**  
100+ 35¢ each  
1000+ 32¢ each  
2500+ 26¢ each

**INK PRINT**  
100+ 34¢ each  
1000+ 29¢ each  
2500+ 24¢ each

Please allow 2 - 3 weeks  
for printed items from  
approved art.



### Damask Paper Shoppers

- 110 gsm paper
- Minimum order is 100 per size

CODE	TYPE	SIZE (inches)	CASE PACK	PRICE/EACH	
				100+	1000+
23080915D	Petite	8 x 4 x 10 x 4	100	\$0.64	\$0.54
23101315D	Vanity	10 x 5 x 13 x 5	100	\$0.68	\$0.59
23161215D	Fashion	16 x 6 x 12 x 6	100	\$0.81	\$0.70

**DIGITAL PRINT**  
100+ \$2.15 each  
1000+ \$1.99 each  
300 bags minimum

**FOIL PRINT**  
100+ 35¢ each  
1000+ 32¢ each  
2500+ 26¢ each

**INK PRINT**  
100+ 34¢ each  
1000+ 29¢ each  
2500+ 24¢ each

Please allow 2 - 3 weeks for printed  
items from approved art.

All print orders subject to set-up charges. Applicable artwork, and plate charges may apply. See page 122.

# IN STOCK

## Paper Shoppers

The Mission Green Sustainable Solution for single-use plastic merchandise shoppers.



### Kraft Paper Bag with Die Cut Handles

- 70% post-consumer recycled material
- 90 gsm kraft paper
- 125 gsm kraft paper
- Durable reinforced handles
- Minimum order is 250 per color per size

CODE	SIZE (inches)	CASE PACK	PRICE/EACH	
			250+	1000+
White:				
23101300WF	10 x 3.14 x 13 x 3.14	250	\$0.26	\$0.23
23141800WF	14 x 3.14 x 18 x 3.14	250	\$0.33	\$0.30
Kraft:				
23141812KF	14 x 3.14 x 18 x 3.14	250	\$0.29	\$0.25

### Merchandise Die Cut Bags

- Reinforced fold-over handle plus side gusset
- 80 gsm paper

CODE	SIZE (inches)	CASE PACK	PRICE/EACH
23081275	8 x 2 x 12	500	\$0.31
23101575	10 x 2 x 15	500	\$0.34
23141875	14 x 4 x 18	250	\$0.47



### Merchandise Bags

- 110 gsm paper

CODE	SIZE (in)	CASE	75 - Kraft	00 - White
			PRICE/EACH	PRICE/EACH
230609__	6 x 9	2000	\$0.05	\$0.07
230710__	7 x 10	500	\$0.06	\$0.07
230912__	9 x 12	500	\$0.07	\$0.10
231114__	11 x 14	500	\$0.09	\$0.13
231316__	13 x 16	500	\$0.14	\$0.18



**DIGITAL PRINT**  
100+ \$2.15 each  
1000+ \$1.99 each  
300 bags minimum

**FOIL PRINT**  
100+ 35¢ each  
1000+ 32¢ each  
2500+ 26¢ each

**INK PRINT**  
100+ 34¢ each  
1000+ 29¢ each  
2500+ 24¢ each

Please allow 2 - 3 weeks for printed items from approved art.

# IN STOCK

## Food Service Paper

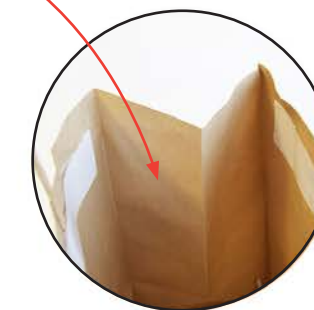

Tamper Proof Strips Across Both Sets of Handles



### Food Service Kraft Paper Shoppers

- Sturdy and durable
- 110 gsm
- Made from 100% recycled kraft paper

CODE	DESCRIPTION	SIZE (inches)	CASE PACK	PRICE/EACH	
				250+	1000+
A 23121775F	SOS Shopper	12 x 7 x 17 x 7	250	\$0.22	\$0.20
B 23141512F	Paper Twist with Tamper Tape	14 x 10 x 15.5 x 10	200	\$0.69	\$0.59

**DIGITAL PRINT**  
100+ \$2.15 each  
1000+ \$1.99 each  
300 bags minimum

**INK PRINT**  
100+ 34¢ each  
1000+ 29¢ each  
2500+ 24¢ each

**FOIL PRINT**  
100+ 35¢ each  
1000+ 32¢ each  
2500+ 26¢ each

Please allow 2 - 3 weeks for printed items from approved art.

All print orders subject to set-up charges. Applicable artwork, and plate charges may apply. See page 122.

All print orders subject to set-up charges. Applicable artwork, and plate charges may apply. See page 122.

# CREATE YOUR OWN LOOK

## Full Color Simply Poly Shopping Bags

Make a creative impression...  
the combinations are endless!



### Poly Shopping Bags

Customize simply and affordably.

CODE	TYPE	STANDARD PRINT SIZE
550907	Small Gift	5" wide
550414	Wine	2.5" wide
550810	Petite	5" wide
551612	Fashion	9" wide
551816	Majestic	10" wide

- Print two sides in 1 ink color (maximum 25% ink coverage)
- Constructed of 3.0 mil high density poly
- Coordinating poly loop handles included in price
- Poly Shoppers minimum quantity 3,000 per size

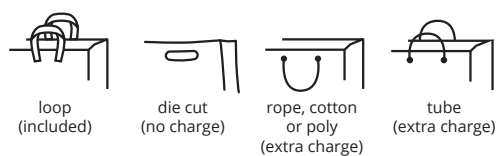

### No Plate Charges\*

\*Does not include process plates.

### Poly Merchandise Bags

CODE	SIZE (in)	STANDARD PRINT SIZE
550912	9 x 12	6" wide
551114	11 x 14	7" wide
551216	12 x 16 + 3	8" wide
551416	14 x 16 + 3	10" wide
551720	17 x 20 + 4	12" wide
551816	18 x 16 + 4	13" wide
552020	20 x 20 + 4	14" wide
552024	20 x 24 + 4	14" wide

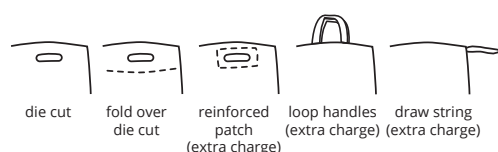

- Constructed of 1.5 mil gauge poly.
- Minimum quantity 5,000 (small sizes)/ 3,000 (large sizes).
- Print two sides in 1 ink color (maximum 25% ink coverage).



**Create Your Own Look:**  
Choose your bag style. Send us your artwork. For 100% full color design, speak to your sales representative.

Estimated lead time: 14 - 16 weeks for printed items from approved art.

# IN STOCK Poly Shoppers



### Frosted Translucent Bags

Estimated lead time: 2 - 3 weeks for printed items from approved art.

- 2.0 mil clear HDPE merchandise, and 3.0 mil clear HDPE shoppers
- Minimum order one case pack
- Please allow 2 - 3 weeks for printed items from approved art

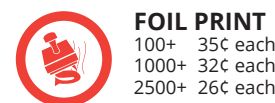

**FOIL PRINT**  
100+ 35¢ each  
1000+ 32¢ each  
2500+ 26¢ each

CODE	TYPE	GAUGE	SIZE (in)	CASE PACK	PRICE/EACH
A 55091200E	Merchandise	2.0	9 x 12	1000	\$0.11
B 55141800E	Merchandise	2.0	14 x 18 + 3	1000	\$0.20
C 55081000E	Petite Shopper	3.0	8 x 4 x 10 x 4	250	\$0.33
D 55161200E	Fashion Shopper	3.0	16 x 6 x 12 x 6	250	\$0.46
E 55181600E	Majestic Shopper	3.0	18 x 6 x 16 x 6	250	\$0.51



### Foil Printed Merchandise Bags

- Constructed of 1.75 mil low density poly
- Foil Printing is available on one side only and is included in the price of the printed bags
- Minimum one case pack, printed and unprinted
- Die charge extra
- For no-print option please add N to code number

Estimated lead time: 2 - 3 weeks for printed items from approved art.

CODE	HANDLE TYPE	SIZE (inches)	CASE PACK	PRICE/EACH		
				1000	3000	1000
				Foil Print	NO PRINT	
A 220609 __ *	Notion	6 x 9	1000	\$0.20	\$0.15	\$0.11
B 220811 __ *	Die Cut	8.25 x 11	1000	\$0.26	\$0.20	\$0.16
C 221114 __ *	Die Cut	11 x 14	1000	\$0.28	\$0.22	\$0.17
D 221418 __	Die Cut	14.5 x 18	1000	\$0.36	\$0.30	\$0.20
E 221721 __	Patch	16.5 x 20 + 4	500	\$0.42	\$0.37	\$0.23

\* Gold available in 3 sizes only

All print orders subject to set-up charges. Applicable artwork, and plate charges may apply. See page 122.

# CREATE YOUR OWN LOOK

## Reusable Fabric Style Shoppers

Make a creative impression...  
the combinations are endless!



## Full Color Laminated Bags

- Plates extra per design/side.  
Additions for extra charge
- Add matte lamination /bag
  - Add a carded bottom /bag
  - Zipper top /bag
  - Gusset print /bag

### Shopping Bags (inches)

- 9 x 4 x 11 x 4
- 11 1/4 x 4 1/4 x 12 x 4 1/4
- 14 x 4 x 16 x 4
- 16 x 6 x 12 x 6
- 16 x 5 x 15 x 5

80 GSM NON-WOVEN  
SILK SCREEN PRINT ONE COLOR 2 SIDES  
1"X24" HANDLES - "X" STITCH

100 GSM NON-WOVEN WITH LAMINATION  
PRINT 4 COLOR PROCESS  
1"X24" PP WEBBING HANDLES - "X" STITCH

120 GSM PP WOVEN WITH LAMINATION  
PRINT 4 COLOR PROCESS  
1"X24" PP WEBBING HANDLES - "X" STITCH



### Non-woven Polypropylene

Soft, yet durable. Use this for light to medium weight loads.



### Woven Polypropylene

Our strongest material. This rigid weave will handle heavy items.

Many more sizes available  
- just ask!



**Create Your Own Look:**  
Choose your bag style.  
Send us your artwork.  
For 100% full color design, speak to your sales representative.

- Minimum quantity 2,000 per size

Estimated lead time: 14 - 16 weeks for printed items from approved art.

# IN STOCK

## Reusable RPET Laminated Tote



## Mission Green Sustainable solution made with 80% recycled RPET + Lamination

- 100 gsm with matte lamination
- Corner sewn style with RPET handle
- Small bag made with 7 recycled plastic bottles
- Large bag made with 11 recycled plastic bottles
- Eco-friendly, durable, recycled

RPET is known as Recycled Polyethylene Terephthalate. It's a strong, durable material constructed from 80% recycled plastic bottles.



80% Recycled PET

CODE	SIZE (inches)	CASE PACK	PRICE/EACH	
			100+	1000+
21081035R	8 x 4 x 10 x 4	100	\$1.47	\$1.17
21141635R	14 x 6 x 16 x 6	100	\$2.12	\$1.70



**DIGITAL PRINT**  
100+ \$2.15 each  
1000+ \$1.99 each  
300 bags minimum



**FOIL PRINT**  
100+ 35¢ each  
1000+ 32¢ each  
2500+ 26¢ each

Please allow 2 - 3 weeks for printed items from approved art.

All print orders subject to set-up charges. Applicable artwork, and plate charges may apply. See page 122.

# SPECIAL ORDER

## Reusable Fabric Shoppers

# IN STOCK

## Reusable Shoppers

BAGS

BAGS



**New**

### Upcycle Laminated Totes

- RPET plus matte lamination
- W-fold bottom
- Eco-friendly, durable, recycled
- Small bag made of 2 water bottles - 140 gsm
- Medium bag made of 5 water bottles - 155 gsm
- Large bag made of 7 water bottles - 155 gsm

CODE	DESCRIPTION	SIZE (inches)	CASE PACK	PRICE/EACH	
				150+	1000+
245905 __	Small*	8 x 10 x 5.25	225	\$1.05	\$1.05
245906 __	Medium**	12 x 14 x 7	150	\$1.46	\$1.46
245907 __	Large**	18 x 14 x 7.5	75	\$1.84	\$1.84

\* 08 - Grey (available while quantities last)  
 \*\* 08 - Grey (out of stock)



Top Turn Graphics Illustrate Recycled Bottle Content

Available Colors



15 - Black    08 - Grey    00 - White

Please allow 3 - 5 weeks for printed items from approved art.



**FOIL PRINT**  
 75+ 35¢ each  
 1000+ 32¢ each  
 2500+ 26¢ each

Metallic Foil, Gloss Clear, Gloss Black and Satine Foil only.



### Toronto Totes

CODE	DESCRIPTION	SIZE (inches)	CASE PACK	PRICE/EACH	
				100+	1000+
215909 __	Small Tote	9 x 5 x 12 x 5	100	\$1.70	\$1.52
215916 __	Large Tote	16 x 6 x 14 x 6	100	\$1.68	\$1.38



**FOIL PRINT\***  
 100+ 35¢ each  
 1000+ 32¢ each  
 2500+ 26¢ each



**DIGITAL PRINT**  
 100+ \$2.15 each  
 1000+ \$1.99 each  
 300 bags minimum



15 - Black with White    00 - White with Black

\* Only Gold, Silver, White and Black foil is available for printing..

Please allow 3 - 5 weeks for printed items from approved art.



A    B



C



D



E



F

CODE	DESCRIPTION	SIZE (inches)	CASE PACK	PRICE/EACH	
				100+	1000+
A 21141615B	Black Tote with 4" gusset	14 x 4 x 16 x 4	100	\$1.77	\$1.26
B 21111315BW	Six Bottle Wine Tote	11.5 x 7.25 x 13 x 7.25	100	\$2.47	\$2.19
C 21141655B	Black Tote with 8" gusset	14 x 8 x 16 x 8	100	\$1.90	\$1.39
D 21141609R	Red Tote with 8" gusset	14 x 8 x 16 x 8	100	\$1.90	\$1.39
E 21141675C	Large Kraft Composite Tote	14 x 6 x 16 x 6	100	\$2.43	\$2.43
F 21081075C	Small Kraft Composite Tote	8 x 4 x 10 x 4	100	\$1.29	\$1.62



**DIGITAL PRINT**  
 100+ \$2.15 each  
 1000+ \$1.99 each  
 300 bags minimum



**FOIL PRINT**  
 100+ 35¢ each  
 1000+ 32¢ each  
 2500+ 26¢ each



**SCREEN PRINT**  
 100+ \$1.25 each  
 500+ \$1.08 each  
 1000+ 90¢ each

Estimated lead time:  
 2 - 3 weeks for printed items from approved art.

All print orders subject to set-up charges. Applicable artwork, and plate charges may apply. See page 122.

All print orders subject to set-up charges. Applicable artwork, and plate charges may apply. See page 122.

# IN STOCK

## Non-Woven Garment Covers

Great for resale or promotions!

CODE	SIZE (inches)	CASE PACK	PRICE/EACH UNPRINTED
A 21244015	24 x 42	100	\$3.01
B 21245415	24 x 54	100	\$3.79
C 21247215	24 x 72 + 4	100	\$7.15

Silk screen set-up charge: \$75.00

Please allow 2-3 weeks for printed items from approved art.



### SCREEN PRINT

100+ \$1.25 each  
500+ \$1.08 each  
1000+ 90¢ each



A

Suit Bag 24" x 42"

B

Coat Bags 24" x 54"

C

Gown Bags  
24" x 72" + 4"  
gusset all around

LOOP FOR FOLDING OVER

**In Stock**  
One roll, white with no print  
**\$373.75** any size  
21214000S, 21215400S, 21217300S



# CREATE YOUR OWN LOOK

## Non-Woven Garment Covers

Custom Colors Available

SIZE	DESCRIPTION
24 x 42	Suit Bag
24 x 54	Coat Bag
24 x 72 + 4	Gown - Black

Please allow 14 - 16 weeks from approved art for delivery.  
Minimum 1000 per size.

Pricing includes printing on one side with one color.

# BOXES

GIFT AND APPAREL



# SPECIAL ORDER

# IN STOCK

## Malibu Magnetic Closure Gift Box

Dual purpose - great for gifting and use after. Perfect for e-commerce business subscriptions.

- Smooth paper covering
- Magnetic closures
- Three colors and three sizes
- Inserts available via special order. Ask your representative



00 - White

11 - Pewter

15 - Black

Please allow 3-5 weeks for printed items from approved art.



**FOIL PRINT**  
Exterior and interior lid  
40/60/100+ 35¢ each  
1000+ 32¢ each  
2500+ 26¢ each



CODE	DESCRIPTION	SIZE (in)	CASE PACK	PRICE/EACH	
				40+	1000+
454103 __	Small	8.5 x 2.75 x 1.625	100	\$3.09	
454104 __	Medium	7.25 x 5.5 x 1.375	60	\$4.25	
454116 __	Large	10.75 x 7.125 x 1.625	40	\$5.04	

## Tuckit® Folding Gift Boxes

- One piece boxes fold and tuck together for a solid bottom
- 18 sizes available • 100% recycled content (min. 35% post consumer) - kraft excluded

Bottom tucks into place for a secure fit.



12P - Kraft Pinstripe

00 - Gloss White



29 - Gloss Red

55 - Gloss Black



CODE	SIZE (inches)	CASE PACK	ECONO WHITE PRICE/EACH		KRAFT PRICE/EACH		GLOSS COLORS PRICE/EACH	
			100+	1000+	100+	1000+	100+	1000+
334103 __	3 x 3 x 2	100	\$0.36	\$0.33	\$0.32	\$0.29	N/A	N/A
334180 __	3 x 3 x 3	100	\$0.31	\$0.29	\$0.34	\$0.30	N/A	N/A
334111 __	4 x 4 x 4	100	\$0.42	\$0.38	\$0.41	\$0.37	\$0.70	\$0.64
334115 __	6 x 4.5 x 4.5	100	\$0.61	\$0.55	\$0.64	\$0.58	\$0.90	\$0.83
334113 __	6 x 6 x 4	100	\$0.80	\$0.73	\$0.80	\$0.73	\$1.25	\$1.15
334114 __	6 x 6 x 6	100	\$0.87	\$0.79	\$1.02	\$0.93	\$1.24	\$1.20
334120 __	8 x 8 x 3.5	100	\$1.37	\$1.24	\$1.40	\$1.27	\$1.88	\$1.72
33412100	8 x 8 x 6	50	\$2.04	\$1.70	N/A	N/A	N/A	N/A
33412200	8 x 8 x 8.5	100	\$2.46	\$2.05	N/A	N/A	N/A	N/A
334119 __	9 x 4.5 x 4.5	100	\$0.84	\$0.76	\$0.93	\$0.85	\$1.25	\$1.18
334183 __	10 x 5 x 4	100	\$0.96	\$0.88	\$0.79	\$0.72	N/A	N/A
* 334124 __	10 x 10 x 6	50	\$2.42	\$2.20	\$2.62	\$2.38	\$4.43	\$4.06
* 334131 __	12 x 6 x 6	50	\$1.48	\$1.35	\$1.33	\$1.21	\$1.74	\$1.58
* 334125 __	12 x 12 x 2.5	50	\$1.70	\$1.55	\$2.39	\$2.18	\$2.72	\$2.83
* 334136 __	12 x 12 x 5.5	50	\$2.92	\$2.66	\$3.26	\$2.96	\$3.20	\$2.91
334186 __	14 x 6 x 6	50	\$2.15	\$1.95	\$2.50	\$2.27	N/A	N/A
33414500	14 x 14 x 5	25	\$3.89	\$3.54	N/A	N/A	N/A	N/A
33416700	16 x 16 x 7	25	\$5.32	\$4.84	N/A	N/A	N/A	N/A

\* not available in Gloss Black

100% recycled content (min. 35% post consumer) - kraft excluded



**FOIL PRINT**  
50/100+ 35¢ each  
1000+ 32¢ each  
2500+ 26¢ each

Please allow 3 - 5 weeks for printed items from approved art.



## White Foldings

- Our most economical option ships flat and stores flat
- Please allow 2 - 3 weeks for printed items from approved art

Please allow 2 - 3 weeks for printed items from approved art.



**FOIL PRINT**  
50/100+ 35¢ each  
1000+ 32¢ each  
2500+ 26¢ each



**INK PRINT**  
50/100+ 34¢ each  
1000+ 29¢ each  
2500+ 24¢ each

CODE	DESCRIPTION	SIZE (inches)	CASE	PRICE/EACH	
				100+	1000+
32058003	G58 Baby Mugs	3.5 x 3.5 x 2	100	\$0.25	\$0.23
32001003	G1 Mugs	4 x 4 x 4	100	\$0.27	\$0.25
32002003	G2 Cups and Saucers	6 x 6 x 4	100	\$0.38	\$0.32
32043003	G43 Bowls, etc.	10 x 8 x 4	100	\$0.54	\$0.51
32033003	G33 Bowls, etc.	10 x 10 x 6	100	\$1.26	\$1.12
32005003	G5 Teapots, etc.	8 x 8 x 5	100	\$0.78	\$0.69
32006003	G6 Teapots, etc.	8 x 8 x 8	100	\$1.13	\$1.02
32048003	G48 Fork, Knife, Spoon	13 x 4 x 2	100	\$1.33	\$1.20
32036003	G36 Casseroles	11 x 11 x 4.5	100	\$1.14	\$1.01
32013003	G13 Plates	5 x 5 x 2	100	\$0.37	\$0.31
32004003	G4 Plates	8 x 8 x 2	100	\$0.65	\$0.55
32008003	G8 Plates	11 x 11 x 2	100	\$0.78	\$0.69
32009003	G9 Plates	13.5 x 13.5 x 2	100	\$1.06	\$0.97
32040003	G40 Plates	15 x 15 x 2	100	\$1.48	\$1.34
32003003	G3 All purpose	7 x 4 x 3	100	\$0.45	\$0.41
32010003	G10 All purpose	9 x 4.5 x 4.5	100	\$0.49	\$0.44
32038003	G38 All purpose	12 x 4 x 4	100	\$0.64	\$0.58
32041003	G41 All purpose	10 x 7 x 7	100	\$0.93	\$0.87
32224003	G24* 2-Piece Boxes - Base	6 x 6 x 10	100	\$0.56	\$0.51
32124003	G24* 2-Piece Boxes - Lid		100	\$0.56	\$0.51

\* Must be ordered together. Pricing shown is for base and lid combined.

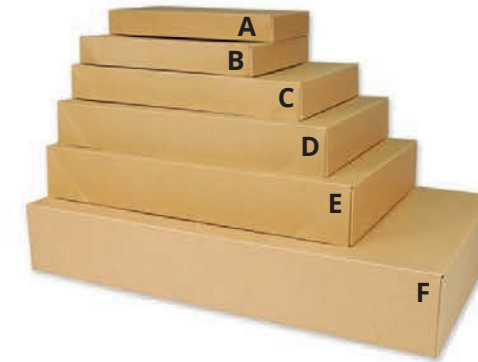

## Apparel Boxes

Seven sizes\* and four colors to choose from!

- Minimum order quantity is one case pack
- Please allow 2 - 3 weeks for printed in stock boxes from approved art

### IN STOCK COLORS



### SPECIAL ORDER COLOR

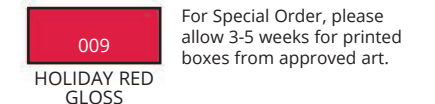

For Special Order, please allow 3-5 weeks for printed boxes from approved art.

CODE	DESCRIPTION	CASE SIZE (inches)	PACK	WHITE PRICE /EACH		KRAFT PINSTRIPE PRICE/EACH		COLORS PRICE/EACH	
				100+	1000+	100+	1000+	100+	1000+
A 32072 ___	Glove/Sock*	11.5 x 5.5 x 1.5	100	\$1.04	\$0.86	\$1.16	\$0.96	—	—
B 32073 ___	Lingerie/T-Shirt	11.5 x 8.5 x 1.625	100	\$1.17	\$0.97	\$1.21	\$1.01	\$2.11	\$1.76
C 32075 ___	Shirt	15 x 9.5 x 2	100	\$1.28	\$1.07	\$1.36	\$1.13	\$2.94	\$2.45
D 32076 ___	Sweater/Dress	17 x 11 x 2.5	50	\$2.16	\$1.80	\$2.28	\$1.90	\$4.09	\$3.40
E 32077 ___	Jacket/Robe	19 x 12 x 3	50	\$2.88	\$2.40	\$2.68	\$2.32	\$4.71	\$4.08
F 32078 ___	Coat/Gown*	24 x 14 x 4	25	\$4.59	\$3.97	\$4.82	\$4.17	\$7.09	\$6.14
G 32071 ___	Sweater (white only) (not shown)	15 x 11 x 4.5	50	\$3.47	\$3.01	—	—	—	—

\* Kraft pinstripe/White only



**FOIL PRINT**  
25/50/100+ 35¢ each  
1000+ 32¢ each  
2500+ 26¢ each



**INK PRINT**  
25/50/100+ 34¢ each  
1000+ 29¢ each  
2500+ 24¢ each

# CREATE YOUR OWN LOOK

# E-Commerce



# CREATE YOUR OWN LOOK

Eco-Friendly, Recyclable  
E-Commerce Packaging



## Custom E-Commerce Gift Boxes

Go above and beyond to impress customers and exceed their expectations by delivering more than just a product, but also an experience.

- Please allow 12 - 14 weeks for printed items from approved art

### SIZE (inches)

10 x 6 x 4
11.125 x 8.75 x 4
14.5 x 7.25 x 5
17 x 12 x 4.25
17.125 x 11.125 x 2

**NO PLATE CHARGES!**

## Custom Poly Mailers

- 2.0 mil co-extruded LDPE film
- White exterior with black interior
- 2" adhesive lip
- Plate charges apply
- Please allow 12 - 14 weeks for printed items from approved art

### SIZE (inches)

9 x 12 + 2
12 x 15 1/2 + 2
14 1/2 x 19 + 2
19 x 24 + 2

### OTHER TYPES OF MAILERS AVAILABLE:

Product Description	Minimum Qty
Recycled Poly Mailers	25,000+
Padded Paper Mailers	40,000+
Paper Apparel Mailers	10,000+
Rigid Paper Mailers	10,000+
Bubble Poly Mailers	25,000+



50% Recycled Shell  
Made in the US

### Ask Your Representative For Details On Personalizing Your E-Commerce Mailers

10,000 minimum  
1, 2 or 4 color process. One or both sides



### Create Your Own Look:

Choose your box style.  
Send us your artwork.  
For 100% full color design, speak to your sales representative.

# IN STOCK

Available for immediate shipment.

Deliver the 'in-store' experience to your customer's door.



## Gift and Apparel Ecommerce

- Reversible kraft with oyster or black interior
- Study E Flute for safe delivery in 3 sizes
- Pack flat with 50 pieces/carton

CODE	SIZE (inches)	CASE	OYSTER/KRAFT PRICE/EACH			BLACK/KRAFT PRICE/EACH		
			50+	500+	1000+	50+	500+	1000+
451009 ___	10.25 x 9.062 x 4.375	50	\$2.20	\$2.01	\$1.78	\$2.52	\$2.29	\$2.07
451511 ___	15.562 x 11.062 x 4.562	50	\$3.02	\$2.61	\$2.36	\$3.20	\$3.01	\$2.70
451612 ___	16.937 x 12.625 x 6.5	50	\$3.48	\$3.02	\$2.59	\$3.68	\$3.13	\$2.70

Add a Special Order Full Color Seal. See page 120.

Add a customized In Stock Seal. See page 118.

Enquire about our Digital Print option!

## Jewelry Boxes

For Geo, Velocity and Horizon packaging.

- Reversible kraft boxes with black or metallic bronze interior
- Black flock inserts available to fit Gold Galleria, Horizon, Geo or Velocity jewelry packaging\*
- Minimum case pack 25



\* Inserts can be special ordered to fit any of our other jewelry packaging collections. Contact your sales representative for a quote.  
Minimum order: 100 per size



**FOIL PRINT**  
25+ 35¢ each  
1000+ 32¢ each  
2500+ 26¢ each

Please allow 2 - 3 weeks for printed items from approved art.

CODE	DESCRIPTION	SIZE (inches)	PRICE/EACH		
			25+	250+	1000+
450505 ___	Small Ecom Box	5.75 x 5.75 x 2.5	\$1.33	\$1.25	\$1.05
451010 ___	Large Ecom Box	10.25 x 10.25 x 2.5	\$2.65	\$2.44	
<b>Gold Galleria/Horizon Inserts</b>					
69221003H	Ring to fit small box		\$0.50	\$0.46	\$0.33
69632003H	T-pad to fit small box		\$0.50	\$0.46	\$0.33
69684003H	Utility to fit small box		\$0.50	\$0.46	\$0.33
69693003H	Bracelet to fit large box		\$0.82	\$0.65	\$0.58
<b>Geo Inserts</b>					
69221153G	Ring to fit small box		\$0.50	\$0.46	\$0.33
69283153G	T-pad to fit small box		\$0.50	\$0.46	\$0.33
69293153G	Bracelet to fit large box		\$0.82	\$0.65	\$0.58
69273153G	Necklace to fit large box		\$0.82	\$0.65	\$0.58
<b>Velocity Inserts</b>					
69321153V	Ring to fit small box		\$0.50	\$0.46	\$0.33
69383153V	Utility pad to fit small box		\$0.50	\$0.46	\$0.33
69393153V	Bracelet to fit large box		\$0.82	\$0.65	\$0.58
69373153V	Necklace to fit large box		\$0.82	\$0.65	\$0.58

All print orders subject to set-up charges. Applicable artwork, and plate charges may apply. See page 122.

# IN STOCK

## Recyclable Ecommerce Mailer

- Natural brown kraft paper
- 150 gsm recycled paper - 40% PCW
- Strong and flexible with 3" gussets
- 1 sku - customizable to sizes



CODE	SIZE (inches)	CASE PACK	PRICE/EACH	
			200+	1000+
52524512	20.5 x 3 x 17.75	200	\$1.01	\$0.86

FOIL PRINT		
200+	35¢ each	
1000+	32¢ each	
2500+	26¢ each	

Eco-Friendly – “Be Proud of the Way You Ship”



### A Recycled Poly Mailers

- IN STOCK -				
CODE	SIZE (in)	CASE	PRICE/EACH	
			1+	4+
52091286	9 x 12	1000	\$0.40	\$0.38
52101386	10 x 13	1000	\$0.42	\$0.40
52121586	12 x 15.5	500	\$0.56	\$0.53

- SPECIAL ORDER -				
CODE	SIZE (in)	CASE	PRICE/EACH	
			1+	4+
52060986	6 x 9	1000	\$0.29	\$0.27
52071086	7.5 x 10.5	1000	\$0.33	\$0.32
52141986	14.5 x 19	250	\$0.93	\$0.88
52192486	19 x 24	125	\$1.51	\$1.43
52242486	24 x 24	125	\$2.05	\$1.94

### B Padded Paper Mailers

- IN STOCK -				
CODE	SIZE (in)	CASE	PRICE/EACH	
			1+	4+
52060976	6 x 9	250	\$0.65	\$0.62
52081176	8.5 x 11	100	\$1.03	\$0.98

- SPECIAL ORDER -				
CODE	SIZE (in)	CASE	PRICE/EACH	
			1+	4+
52101576	10.5 x 15	2 100	\$1.52	\$1.44

### C Paper Apparel Mailers

- IN STOCK -				
CODE	SIZE (in)	CASE	PRICE/EACH	
			1+	4+
52101375	10 x 13	250	\$1.09	\$1.04
52121575	12 x 15.5	150	\$1.46	\$1.39
52101975	10.5 x 4 x 19	100	\$1.74	\$1.64

- SPECIAL ORDER -				
CODE	SIZE (in)	CASE	PRICE/EACH	
			1+	4+
52070975	7 x 9	250	\$0.71	\$0.67

### D Rigid Paper Mailers

- IN STOCK -				
CODE	SIZE (in)	CASE	PRICE/EACH	
			1+	4+
52061012	6 x 10	500	\$0.51	\$0.48
52061212	6 x 2.5 x 12	500	\$0.73	\$0.69
52091412	9.5 x 14.5	250	\$0.89	\$0.84

- SPECIAL ORDER -				
CODE	SIZE (in)	CASE	PRICE/EACH	
			1+	4+
52081212	8.5 x 12	250	\$0.67	\$0.64
52101612	10.5 x 16	250	\$1.07	\$1.01
52121912	12.5 x 19	250	\$1.21	\$1.15

For more product information on recyclability and material content, visit [gunthermele.com](http://gunthermele.com)



FOIL PRINT		
100+	35¢ each	
1000+	32¢ each	
2500+	26¢ each	

PAD PRINT		
100+	35¢ each	
1000+	32¢ each	
2500+	26¢ each	

INK PRINT		
100+	34¢ each	
1000+	29¢ each	
2500+	24¢ each	



# FINISHING TOUCHES

RIBBON, TISSUE, WRAP AND SEALS



All print orders subject to set-up charges. Applicable artwork, and plate charges may apply. See page 122.

# IN STOCK

## Inspirations Gift Wrap

Inspirations  
Giftwrap

By Gunther Mele

Available for immediate shipment.



Inspirations  
Giftwrap

By Gunther Mele

Available for immediate shipment.



# IN STOCK

## Inspirations Gift Wrap



GIFT WRAP

GIFT WRAP

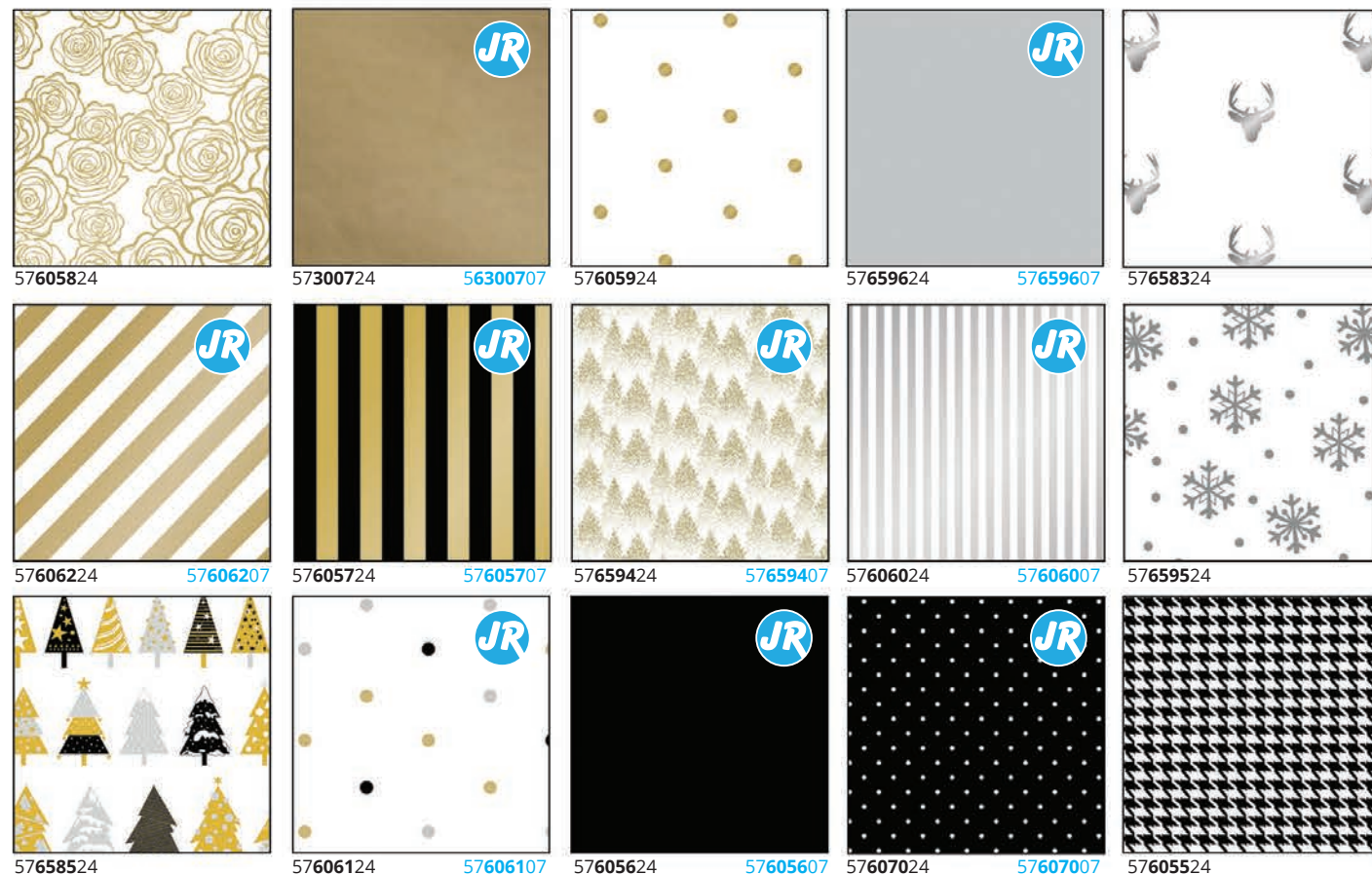

24" x 417' - 1/2 Ream Roll  
**\$100.70** Code # 57 \_\_\_\_ 24  
each

8" x 150' - Jewelers Rolls **\$41.34** Code # 57 \_\_\_\_ 07  
each

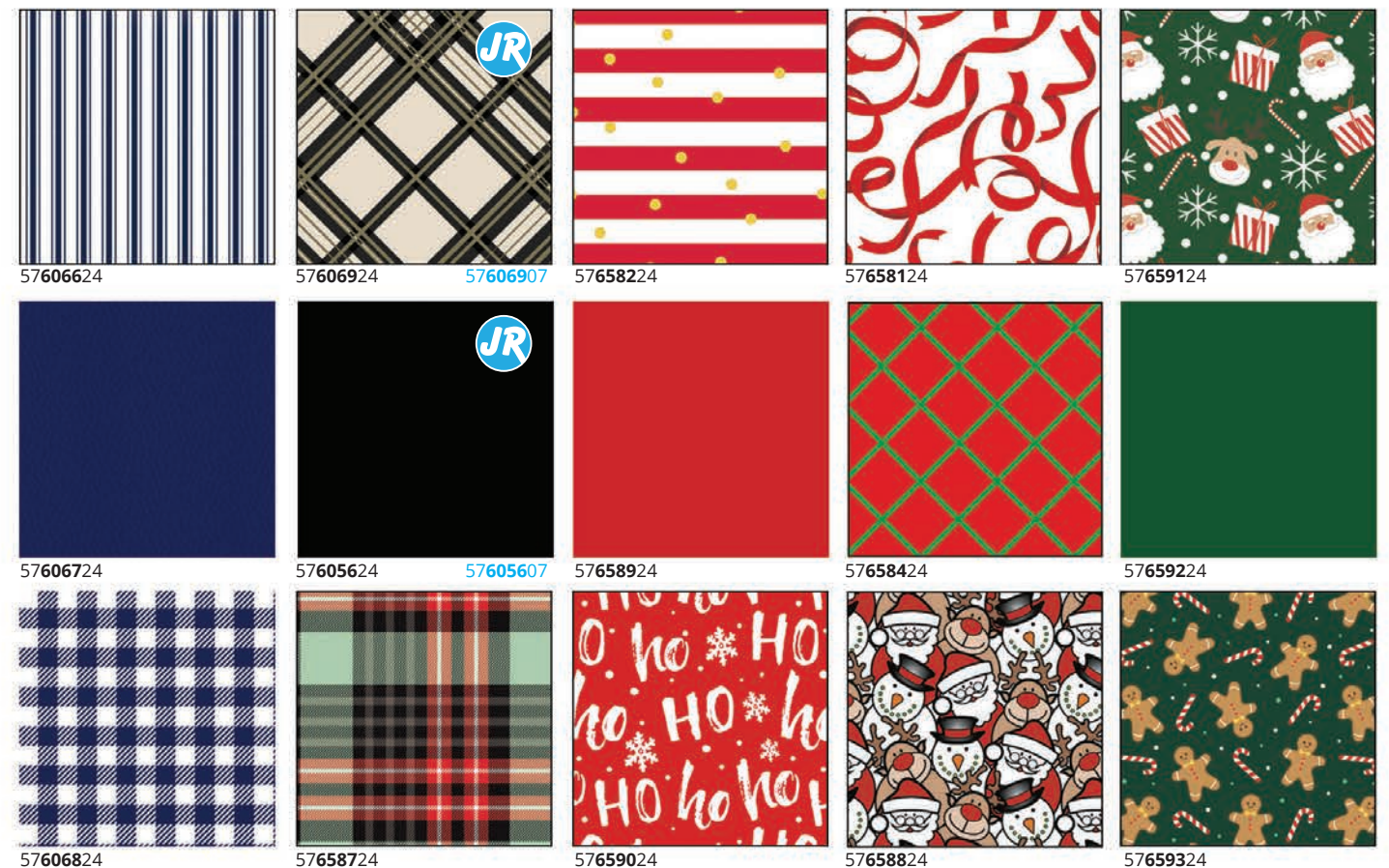

24" x 417' - 1/2 Ream Roll  
**\$100.70** Code # 57 \_\_\_\_ 24  
each

8" x 150' - Jewelers Rolls **\$41.34** Code # 57 \_\_\_\_ 07  
each



# SPECIAL ORDER

## Shamrock Designs Seasonal

Please allow 4 - 6 weeks for shipment.



# SPECIAL ORDER

## Shamrock Designs Every Day

Please allow 4 - 6 weeks for shipment.

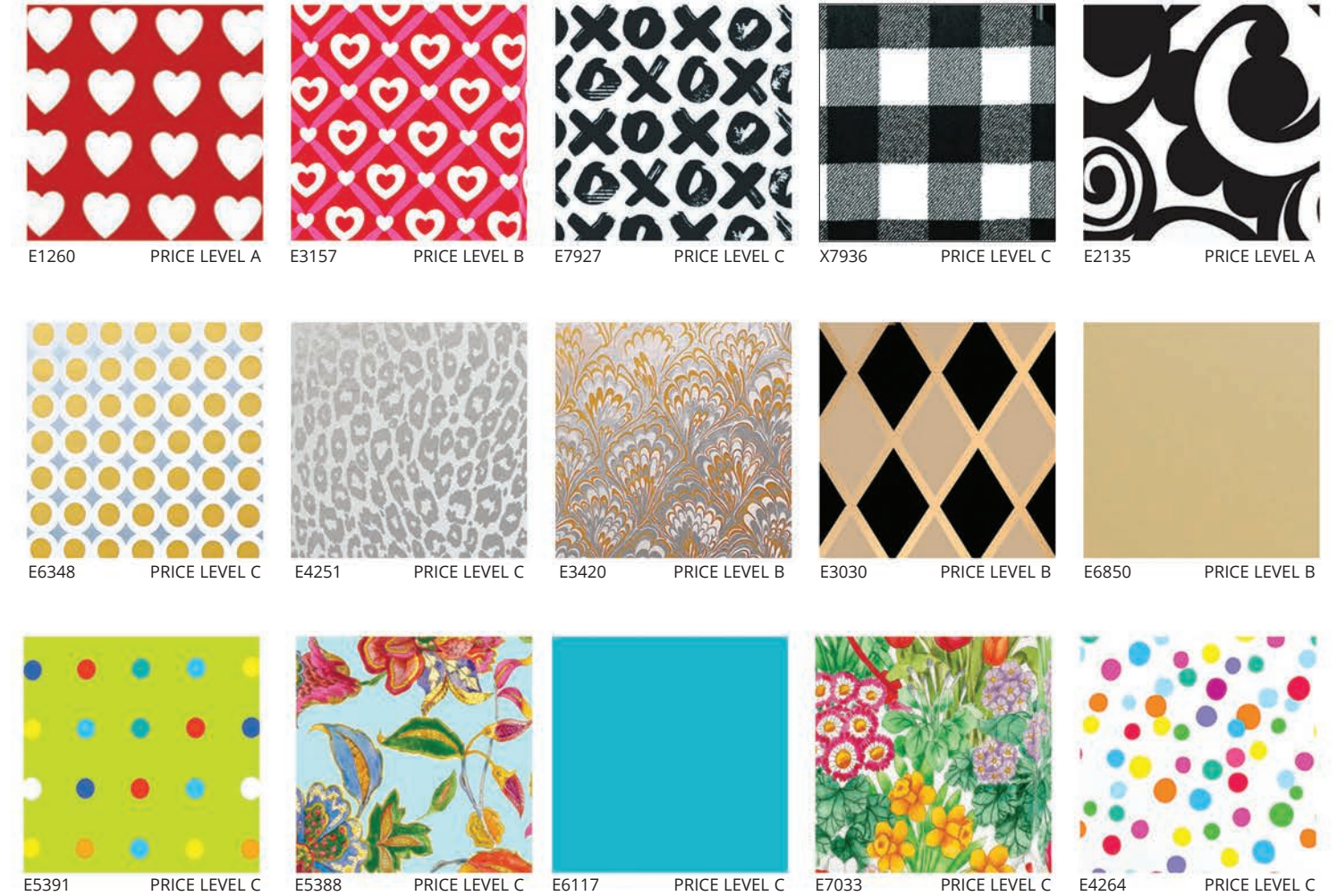

Additional custom order designs available to choose from. Contact your area sales representative for more info.

## Shamrock designs available in Cutter Boxes, 1/2 Ream Rolls and Full Ream Rolls

View our entire  
Selection online at  
[GUNTHERMELE.COM](http://GUNTHERMELE.COM)

NOTE: All Shamrock gift wrap orders must include design code.

MINIMUM ORDER: 1 Roll

**Jewelers Rolls also available. Most are minimum 3 rolls per design.\***

SLITTING CHARGE: A slitting charge of \$25.00 applies to each individual roll. (no more than two slits per roll - 2 slits = \$25.00)

Contact your sales representative for details.\* Select designs available in 1 roll minimums.

Pricing Level	7J	24C	18H	24H	30H	36H	18F	24F	30F	36F
	Jewelers Roll 7.375"x100'	Cutter Box 24" x 100'	Half Ream 18" x 417'	Half Ream 24" x 417'	Half Ream 30" x 417'	Half Ream 36" x 417'	Full Ream 18" x 833'	Full Ream 24" x 833'	Full Ream 30" x 833'	Full Ream 36" x 833'
A	\$25.52	\$53.77	\$179.32	\$154.43	\$255.43	\$255.43	\$277.28	\$261.50	\$431.73	\$431.73
B	\$33.24	\$66.29	\$211.24	\$195.46	\$321.59	\$321.59	\$362.38	\$346.50	\$573.51	\$573.51
C	\$39.56	\$78.91	\$242.90	\$227.03	\$371.58	\$375.12	\$422.26	\$406.48	\$664.81	\$671.14
D	\$42.22	\$84.53	\$259.03	\$243.64	—	—	\$458.91	\$443.29	—	—

# CREATE YOUR OWN LOOK

• Please allow 6 - 8 weeks for printed items from approved art.



**Printed Tissue:** Pick a PMS print color and we will match it.

– See page 105 for Special Order Tissue Colors!

CODE	DESCRIPTION	SIZE (in)	PACKAGED	PRICE/EACH	
				10 REAMS	30 REAMS
20869000G	White	20 X 30	480	\$97.31	\$84.20
20869000M	Colored	20 x 30	480	\$139.49	\$120.70
20869000GK	Kraft	20 x 30	480	\$97.31	\$84.20
20869001M	Metallic SS*	20 x 30	200	\$230.86	\$218.92

\* SS - single sided

Print included in price of tissue.

Minimum 10 reams. Note: Plates extra \$225.00 (per color).  
Ships in approximately 6 - 8 weeks.

For metallic ink print: add 10% to the price above.  
For > 50% ink coverage, an additional \$10 per ream.  
All custom orders subject to a +/-10% over/under run.

Custom Printed  
White Tissue – 10 Reams  
**\$973.10**

# IN STOCK

Available for immediate shipment.

## Spotlight Tissue Colors

CODE	DESCRIPTION	SIZE (in)	PKG	PRICE/EACH		
				1 - 4 REAMS	5+ REAMS	25+ REAMS
20819290S	White Economy	19 x 29	480	\$19.67	\$18.02	\$16.38
208551_G*	Spotlight on Value (colors)	20 x 30	480	\$34.97	\$34.97	\$34.97
208559_G	Spotlight on Value (metallic)	20 x 30	200	\$64.36	\$62.96	\$61.56
20850102	#1 White Economy	19 x 14.5	480	\$9.64	\$8.25	\$6.86
20851800	#1 White Bleached	18 x 9 dia.	1 roll	\$115.10/roll		
20852000	#1 White Bleached	20 x 9 dia.	1 roll	\$123.33/roll		

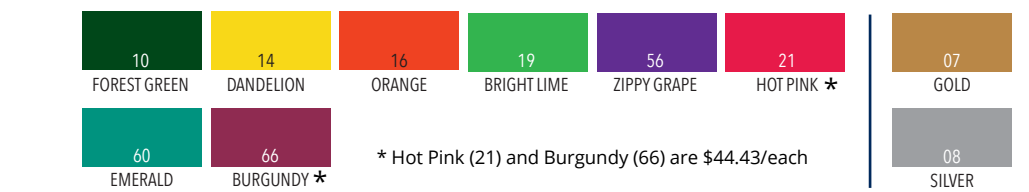

# SPECIAL ORDER

## Unprinted Tissue

Unprinted, minimum 1 ream (per color).  
Ships in approximately 4 - 6 weeks.

CODE	DESCRIPTION	SIZE (in)	Packaged	PRICE/REAM	
				1 REAM	25+ REAMS
20899_--	Special Order Colors	20 x 30	480 sheets	\$42.30	\$38.07



# IN STOCK

Available for immediate shipment.

## Curling Ribbon

See chart for available colors

CODE	PRICE/ROLL
<b>COLORS - 3/16" x 500 yards</b> 148373 __	\$3.79
<b>METALLIC - 3/16" x 250 yards</b> 148378 __	\$10.28



## 2.75" Star Bows

See chart for available colors

CODE	CASE PACK	PRICE/EACH 200+	1000+
<b>COLORS - 2.75" x 17 loop</b> 142311 __	200	\$0.12	\$0.11
<b>METALLIC - 2.5" x 17 loop</b> 14531107 Gold	200	\$0.11	\$0.10
14531108 Silver	200	\$0.11	\$0.10

Min: case pack



## 3.75" Star Bows

See chart for available colors

CODE	CASE PACK	PRICE/EACH 100+	1000+
<b>COLORS - 3.75" x 13 loop</b> 143512 __	200	\$0.14	\$0.15
<b>METALLIC - 3.75" x 17 loop</b> 14551207 Gold	200	\$0.19	\$0.16
14551208 Silver	200	\$0.19	\$0.16

Min: case pack

## Splendor Ribbon

See chart for available colors

CODE	PRICE/ROLL
<b>COLORS - 3/4" x 50 yards</b> 141050 __	\$11.18
<b>METALLIC - 3/4" x 100 yards</b> 14013007 Gold	\$15.24
14013008 Silver	\$15.24

Color # Name	Curling Ribbon	2.75" Star Bows	3.75" Star Bows	Splendor Ribbon
00 - White				
86 - Ivory				
29 - Vanilla				
61 - Pastel Yellow				
03 - Yellow				
13 - Daffodil				
14 - Sunshine Yellow				
07 - Gold				
08 - Silver				
27 - Holiday Gold				
22 - Melon				
73 - Coral				
16 - Tropical Orange				
17 - Orange				
12 - Chocolate				
75 - Baby Pink				
01 - Pink				
80 - Primrose				
57 - Azalea				
52 - Hot Red				
58 - Lava Red				
66 - Burgundy				
41 - Beauty				
59 - Dubonnet Rose				
28 - Orchid				
05 - Lavender				
56 - Purple				
54 - Periwinkle				

Color # Name	Curling Ribbon	2.75" Star Bows	3.75" Star Bows	Splendor Ribbon
50 - Plum				
11 - Royal				
81 - Navy				
77 - Baby Blue				
02 - Light Blue				
47 - Aqua				
32 - Caribbean Blue				
55 - Robin's Egg				
25 - Turquoise				
71 - Sea Green				
18 - Celery				
74 - Spruce				
60 - Hunter				
84 - Teal				
04 - Mint				
19 - Citrus				
96 - Leaf				
30 - Celadon				
10 - Emerald				
70 - Antique Silver				
15 - Black				
07 - Metallic Gold				
08 - Metallic Silver				
09 - Metallic Red				
10 - Metallic Green				
99 - Everyday Assortment	N/A			N/A
98 - Christmas Assortment	N/A			N/A



99 - Everyday Assortment Star Bows Available in 2.75" and 3.75"



98 - Christmas Assortment Star Bows Available in 2.75" and 3.75"



Metallic Star Bows Available in 2.75" and 3.75"

# IN STOCK

Available for immediate shipment.

## Perfect Bows™

Minimum: 50 per size, per color.

CODE	SIZE	PRICE/EACH	
		50+	1000+
140515 __	5.5" Perfect Bow	\$1.18	\$1.07



## Pull Bows

Minimum: 100 per size, per color.

CODE	SIZE	STANDARD COLORS		METALLIC COLORS	
		100+	1000+	100+	1000+
132000 __	Petite 2" Bows	\$0.24	\$0.21	\$0.33	\$0.30
134000 __	Std. 4" Bows	\$0.39	\$0.42	\$0.56	\$0.53



## Mini Metallic Star Bows

252 per tub

CODE	DESCRIPTION	PRICE/TUB
14121099	Assorted	\$35.53
14121017	Gold	\$35.53
14121008	Silver	\$35.53



## Matte Wraphia™

CODE	SIZE	PRICE/ROLL
148367 __	100 yds	\$8.40

## Paper Roll/Ream Dispenser and Tape

CODE	DESCRIPTION	PRICE
09850124	Paper Roll/Ream Roll dispenser - 24" rack	\$71.02 each



## Cellophane (1.0mil)

CODE	DESCRIPTION	SIZE	PRICE/ROLL
16400506	Clear Cellophane	40" x 100'	\$16.82

## Ribbon Shredder

CODE:	09878600
PRICE:	\$7.41 each



## Curling Ribbon Roll Dispenser

CODE:	09850100
PRICE:	\$134.00 each



Holds 12 Rolls

# SPECIAL ORDER

# SPECIAL ORDER

RIBBON

RIBBON

## Printed Satin Ribbon

See chart to the right for ribbon colors.

### Single Face Satin

WIDTH	CODE	PRICE/EA
3/8" x 100 yd roll	14150002	\$41.22
5/8" x 100 yd roll	14150003	\$44.10
7/8" x 100 yd roll	14150005	\$51.32
1-1/2" x 100 yd roll (2 x 50 yd rolls)	14150015	\$82.44

500 yard minimum per width. Note: Plates extra \$94.00 (per color).



Contact your sales representative.



5/8" Single Face Satin Ribbon with Foil Print

Please allow 3 -4 weeks for printed items from approved art.

### Foil Print Colors

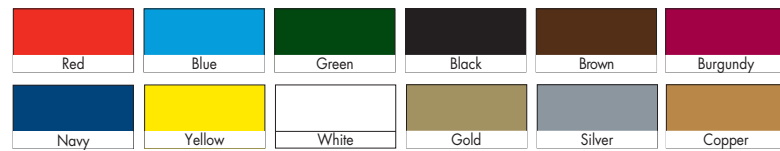

**FOIL PRINT**  
Included in price of ribbon

## Unprinted Satin and Grosgrain Ribbon

Lead time please allow 4 -6 weeks for shipment. SPECIAL ORDER

See chart to the right for ribbon colors.

### Single Face Satin

WIDTH	CODE	PRICE/EA
3/8" x 100 yd roll	14031 ___	\$18.90
5/8" x 100 yd roll	14032 ___	\$21.89
7/8" x 100 yd roll	14033 ___	\$38.02
1-1/2" x 50 yd roll	14034 ___	\$25.11

1 roll minimum.

### Grosgrain

WIDTH	CODE	PRICE/EA
3/8" x 100 yd roll	14160 ___	\$18.41
5/8" x 100 yd roll	14161 ___	\$23.52
7/8" x 100 yd roll	14162 ___	\$36.28
1-1/2" x 50 yd roll	14170 ___	\$18.84

While we strive for accuracy in our catalog, actual product may be slightly different than pictured.

Please allow 3 -4 weeks for printed items from approved art.

3/8"		5/8"		7/8"		1-1/2"		COLOR NUMBER AND NAME	COLOR NUMBER AND NAME
Single Face Satin	Grosgrain	Single Face Satin	Grosgrain	Single Face Satin	Grosgrain	Single Face Satin	Grosgrain		
								029 - White	462 - Royal Orchid
								007 - Shell Grey	464 - Delphinium
								012 - Silver	465 - Purple
								015 - Grey	470 - Regal Purple
								022 - Pewter	473 - Amethyst
								028 - Antique White	528 - Lemon Grass
								813 - Oyster	530 - Mint
								016 - Portobello	533 - Jungle Green
								030 - Black	547 - New Chartreuse
								115 - Powder Pink	548 - Kiwi
								117 - Light Pink	550 - Apple Green
								150 - Pink	558 - Leaf
								156 - Hot Pink	567 - Spring Moss
								175 - Shocking Pink	570 - Moss
								187 - Azalea	580 - Emerald
								241 - Living Coral	586 - New Neon Green
								250 - Red	587 - Forest Green
								252 - Hot Red	617 - Baby Maize
								260 - Scarlet	640 - Lemon
								275 - Wine	645 - Daffodil
								277 - Burgundy	650 - Maize
								285 - Plum	660 - Yellow Gold
								305 - Light Blue	675 - Gold
								331 - Dusty Blue	690 - Old Gold
								312 - Blue	722 - Burnt Sienna
								315 - Navajo Turquoise	743 - Ginger
								329 - Cobalt	750 - Torrid Orange
								340 - Turquoise	789 - Sherry
								343 - Tornado Blue	790 - Currant
								350 - Royal	810 - Ivory
								352 - Electric Blue	815 - Cream
								353 - Century Blue	825 - Natural
								365 - Light Navy	835 - Tan
								370 - Navy	841 - Khaki
								412 - Purple Haze	850 - Brown
								430 - Light Orchid	866 - Coffee
								450 - Orchid	

All print orders subject to set-up charges. Applicable artwork, and plate charges may apply. See page 122.

# IN STOCK

In stock and ready to ship.

## Simply Sheer Asiana Ribbon

Monofilament-Edge



CODE	SIZE	PRICE/ROLL
149435 __	7/8" x 100 yards	\$16.12
149436 __	1 1/2" x 100 yards	\$16.12

• minimum order: one roll.



Can be special ordered in additional colors!

# SPECIAL ORDER

Please allow 4 - 6 weeks for shipment.

## Contessa Ribbon

Wire-Edge  
Single Face Satin



CODE	SIZE	PRICE/ROLL
14163 ___	1 1/2" x 25 yards	\$16.52
*14164 ___	2 1/4" x 25 yards	\$24.78

• minimum order: one roll.



\* 2-1/4" is only available in 029-White, 260-Scarlet and 810-Ivory.

## Encore Ribbon

Wire-Edge



CODE	SIZE	PRICE/ROLL
141650 __	5/8" x 25 yards	\$6.83
141660 __	1 1/2" x 25 yards	\$13.66
141670 __	2 1/2" x 25 yards	\$20.44

• minimum order: one roll.

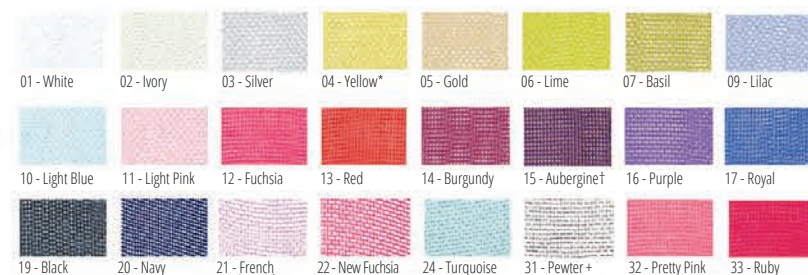

\* not available in 5/8"  
† not available in 2 1/2"

## Garbo Ribbon



CODE	SIZE	PRICE/ROLL
14168 ___	5/8" x 100 yards	\$50.00
14169 ___	1 1/2" x 50 yards	\$38.66

• minimum order: one roll.



\* not available in 5/8"  
† not available in 1 1/2"



Please allow 4 - 6 weeks  
for printed items from  
approved art.

# CREATE YOUR OWN LOOK

## Raised Ink Printing

See chart below for ribbon colors.

Pick your own colors for raised print - NO PLATE CHARGE

Available in: 5/8" x 100 yd roll, 7/8" x 100 yd roll, 1-1/2" x 50 yd roll  
40 roll minimum for all printed ribbon.

## Sheer Ribbon Colors

All colors are available in all sizes. See page 115 for single face satin and grosgrain color availability.



Single Face Satin Ribbon with Raised Print



Sheer Ribbon with Raised Print



Grosgrain Ribbon with Raised Print

# IN STOCK

# IN STOCK

SEALS

SEALS



## Customized Seals-Foil Printed

CODE	SIZE	One color foil print/each		SPECIAL ORDER Two color/each		SPECIAL ORDER Acetate 1 color/each		SPECIAL ORDER Acetate 2 color/each	
		2000+	5000+	2000+	5000+	2000+	5000+	2000+	5000+
25 4 digit label code 2 digit label color	A	\$0.0880	\$0.0820	\$0.1512	\$0.1188	\$0.1728	\$0.1350	\$0.1976	\$0.1533
	B	\$0.1000	\$0.0900	\$0.1620	\$0.1296	\$0.2074	\$0.1630	\$0.2376	\$0.1900
	C	\$0.1200	\$0.1100	\$0.1782	\$0.1447	\$0.2473	\$0.1901	\$0.2786	\$0.2268
	D*	\$0.1350	\$0.1200	\$0.1858	\$0.1544	\$0.3056	\$0.2451	\$0.3348	\$0.2635

**\$77 plate charge**      **NO PLATE CHARGES**



**FOIL PRINT**  
Included in the price.  
Please allow 2-3 weeks for printing.

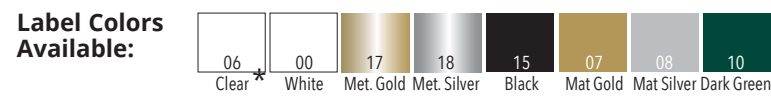

\* D sized Seals and Clear print are SPECIAL ORDER.  
See foil chart on inside back cover of catalog for available print colors.

## Pre-printed Labels

CODE	SIZE	CASE	PRICE/EACH	
			1000+	5000+
25401007S	5/8 x 3/8"	1000	\$0.09	\$0.09
25401407S	5/8 x 3/8"	1000	\$0.09	\$0.09
25406208S	5/8 x 3/8"	1000	\$0.09	\$0.09
25401007V	3/4" oval	1000	\$0.09	\$0.09
25401407V	3/4" oval	1000	\$0.09	\$0.09
25406008V	3/4" oval	1000	\$0.09	\$0.09

1000/box minimum order - 1 box of 1000.

Available for immediate shipment.

For a no-print solution, order our in stock embossed seals.

## Embossed Seals

CODE	SIZE	PRICE/EA
Gold 08701207	1.5" dia.	\$0.04
Silver 08701208	1.5" dia.	\$0.04

ACTUAL EMBOSSED PATTERN 1.5" DIA.

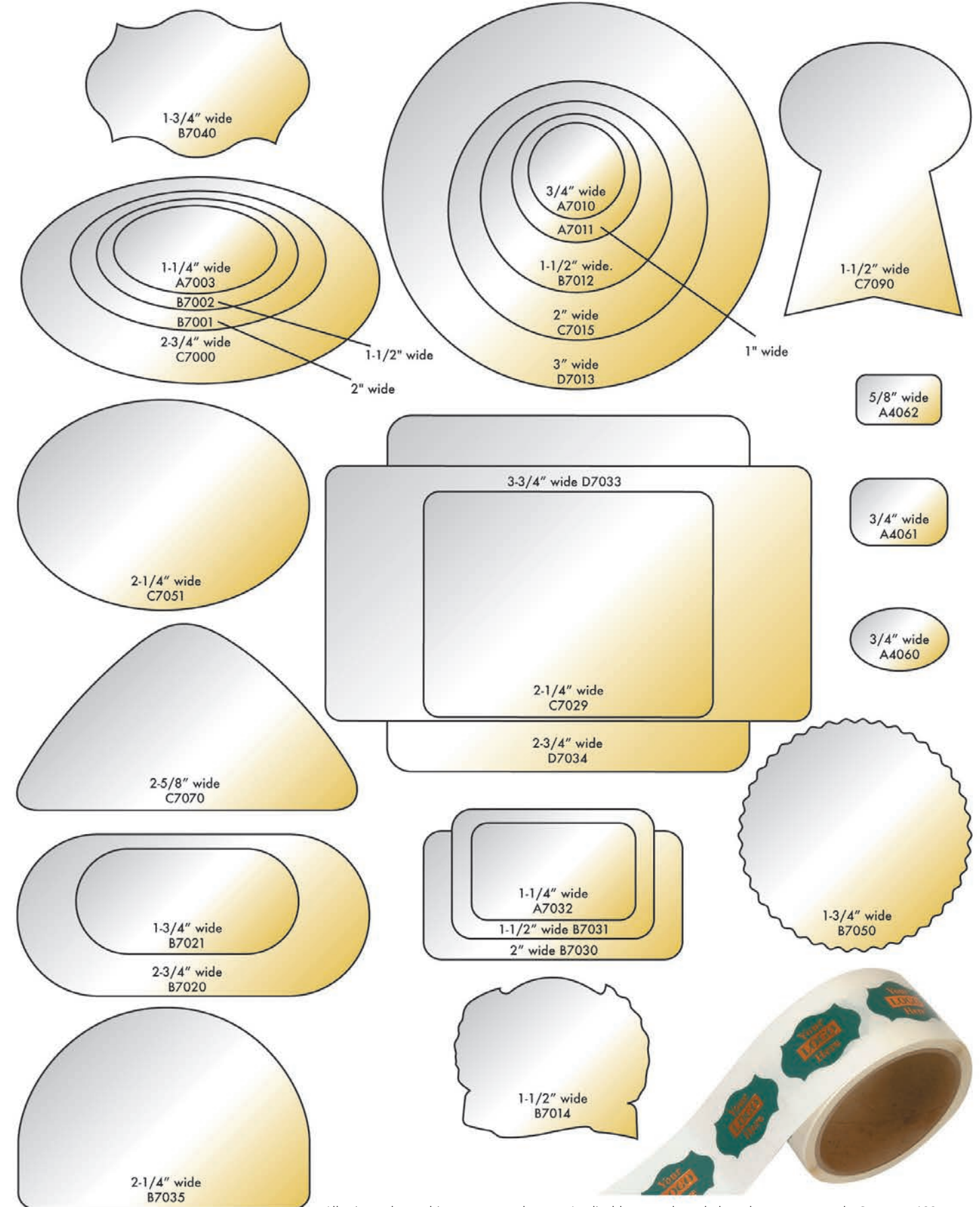

All print orders subject to set-up charges. Applicable artwork, and plate charges may apply. See page 122.

All print orders subject to set-up charges. Applicable artwork, and plate charges may apply. See page 122.

# SPECIAL ORDER

# SPECIAL ORDER

Please allow 4 - 6 weeks for printing from approved art. NO PLATE CHARGE!

## Custom Full Color Seals

Full color, edge to edge print.  
Thirty sizes to choose from.  
"Picture Perfect" Seals

Speak with  
your Sales  
Representative  
to order.

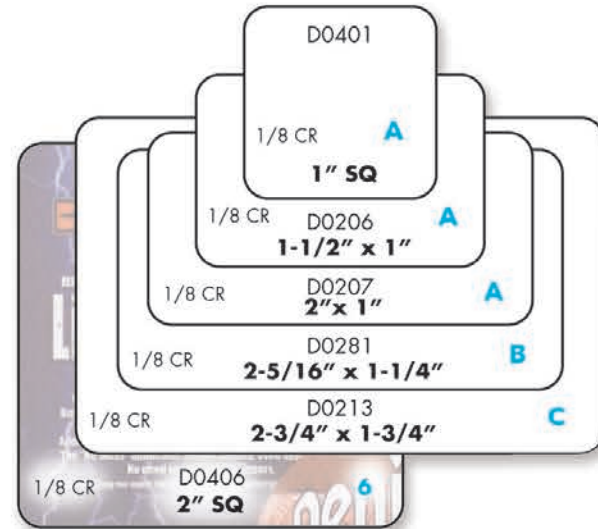

Please allow 4 - 6 weeks for printing from approved art.  
NO PLATE CHARGE!

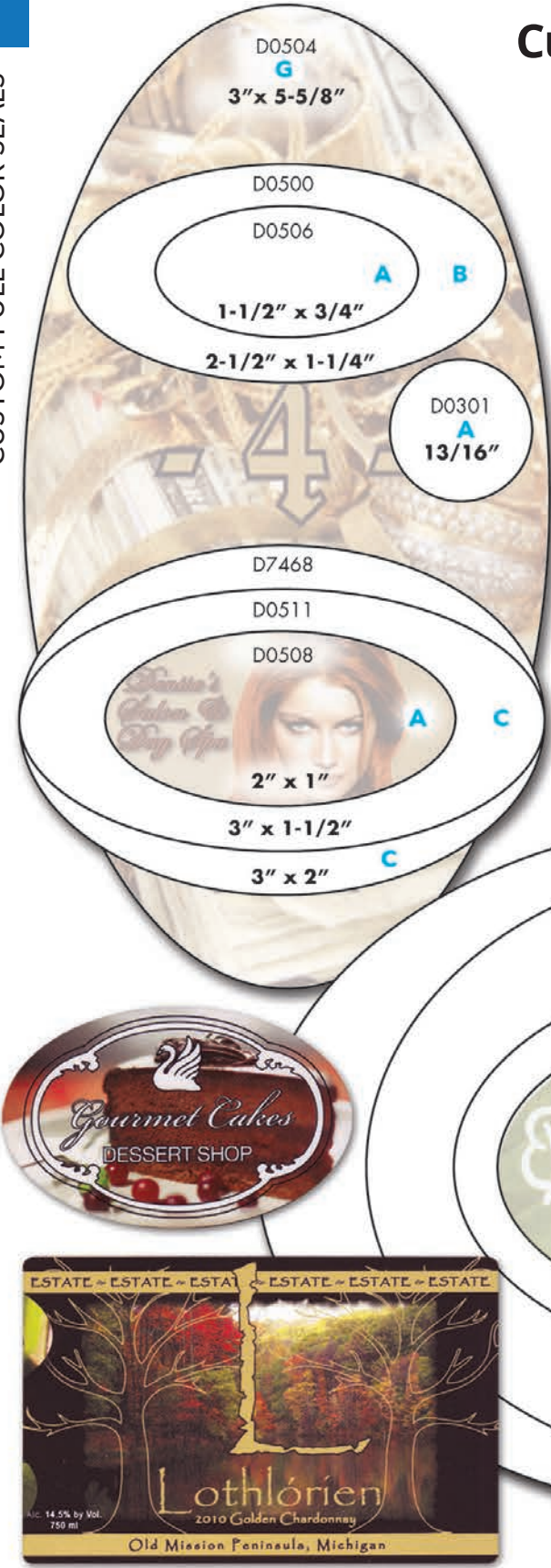

D0504  
3" x 5-5/8"

D0500

D0506  
1-1/2" x 3/4"

2-1/2" x 1-1/4"

D0301  
13/16"

D7468

D0511

D0508  
2" x 1"

3" x 1-1/2"

3" x 2"

D0516

D6004

D0502

D0503

D0501

D0509

D0507  
1-3/8" x 3/4"

2" x 1-1/4"

3" x 1-3/4"

3-1/2" x 2-1/4"

4-1/2" x 3-1/2"

5-3/4" x 4"

5-7/16" x 4-7/8"

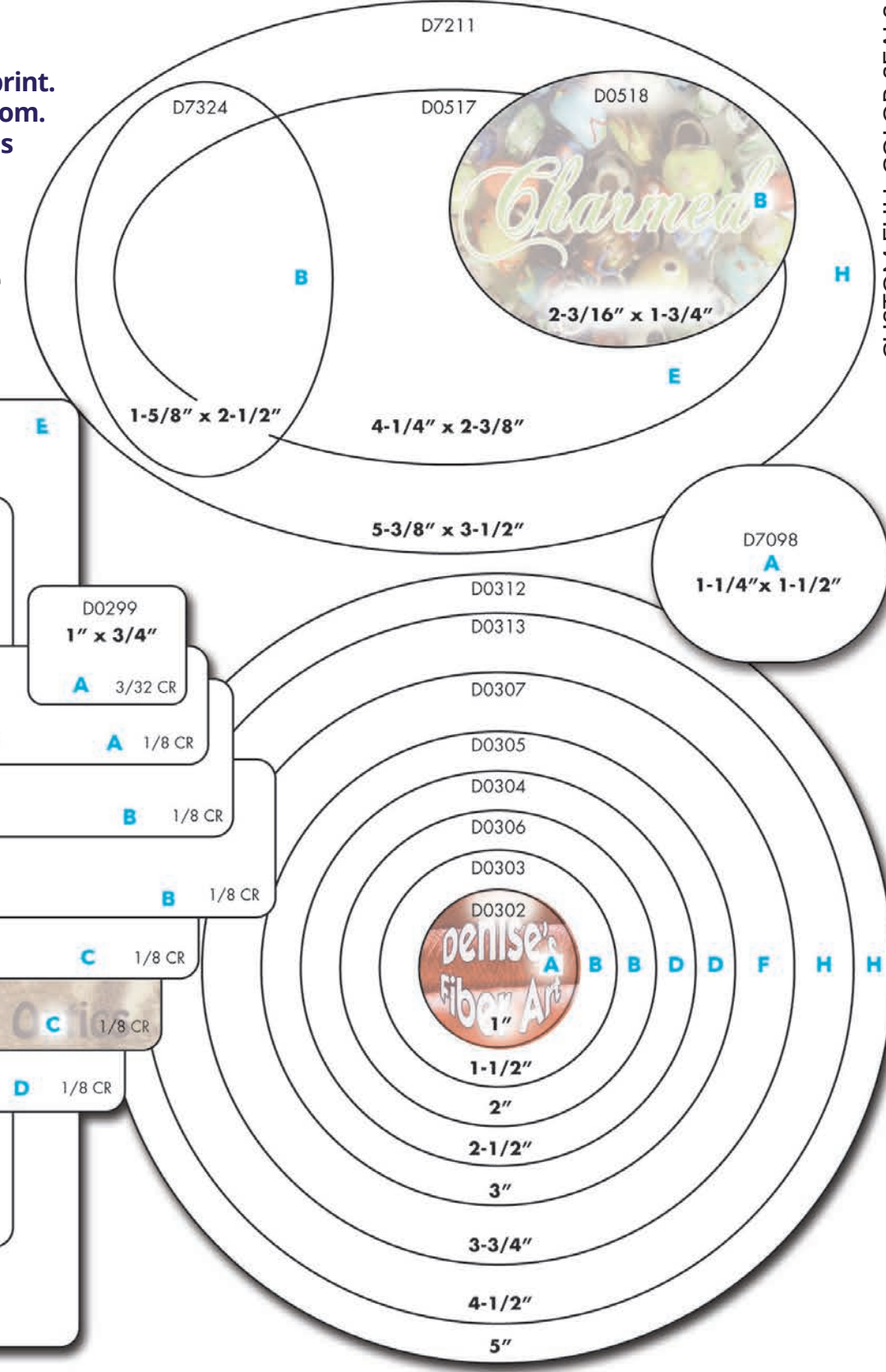

D7211

D7324

D0517

D0518  
2-3/16" x 1-3/4"

1-5/8" x 2-1/2"

4-1/4" x 2-3/8"

5-3/8" x 3-1/2"

D7098  
1-1/4" x 1-1/2"

D0312

D0313

D0307

D0305

D0304

D0306

D0303

D0302  
1"

1-1/2"

2"

2-1/2"

3"

3-3/4"

4-1/2"

5"

1/8 CR D0227

1/8 CR D0228

1/8 CR D0212

D0299  
1" x 3/4"

D0235  
2" x 3/4"

D0272  
2-1/2" x 1"

D0224  
3" x 1"

D0210  
2-3/4" x 1-1/2"

D0221  
3" x 1-1/2"

D7201  
3" x 2"

1-1/2" x 4"





1-3/4" x 4-3/4"

2" x 6"

# PRINTING INFORMATION

Have your name and logo printed... it's easy!

1. Select your box or bag style, color and size.
2. Choose the printing method you wish to use.

-  A. **FOIL PRINTING:** Foil is applied to the bag or box using a combination of heat and pressure on a magnesium print plate to create an elegant appearance. Choice of Metallic or Matte foils. Cost of Foil Printing Print plate per size and color - \$94.00 (maximum 30 square inches)
-  B. **PAD PRINTING:** Ink is applied to smooth surfaces allowing us to print your logo in places never before possible. Cost of Pad Print plate per size and color - \$104.50 (maximum 3.75 square inches)
-  C. **INK PRINTING:** Ink is applied to the box or bag using a rubber printing plate. This method is ideal for larger coverage prints and is economically priced. Cost of Ink Printing Plate per size per color starting at \$137.50. (maximum 25 square inches)
-  D. **SILK SCREEN:** Die fast ink is applied to Fabric Style Bags through a screen. The process allows the ink to permeate into the fabric dimples for optimal coverage. Screen charge of \$65.00 applies with each order.
-  E. **FULL COLOR DIGITAL PRINTING:** Utilizing the latest 4-color process technology, we now offer full color digital printed graphics on fabric and nylon bags using a heat press process. This full color digital printing creates a transfer that allows for vibrant images on both lights and darks. Pricing is the same regardless of the amount of colors used in a design. Have your full color image applied to your bags for just \$2.15 per bag (minimum 300 bags)

### 3. Choose the Print Colour

When Foil Printing, select from 41 foil colours in 4 different finishes: Metallic (High Sheen or Matte), flat, gloss or pearlized. For ink printing select from our 9 standard colours for in stock items, or ask about Pantone Matching for Special Order items such as Simply Bags and Fabric Style Bags.

### 4. Send us your artwork.

If you are a new print customer, send us your artwork by e-mail. Artwork must be vector with fonts outlined or high resolution (300 dpi) actual size jpg if vector can not be located.

If you don't have artwork or your artwork needs adjustments, we have a talented design team who can assist you. Contact one of our sales representatives or email us your ideas today. For pricing, see the artwork charges section.

### Acceptable Artwork Formats

- Vector files (preferred): Adobe Illustrator with .ai, .eps, or .pdf file extension. If the logo was ever professionally made, at a marketing agency, print shop or sign maker, they will have the logo on file. Check with the original graphic designer. If vector cannot be provided, ALL raster formats will be subject to additional art charges as in most cases it will have to be converted to a vector to meet our printers requirements.
- Raster files: (ie. PDF, PSD, TIF, or JPEG) Actual size, high resolution (300dpi or more), is required for all full color reproduction.
- Please include fonts (.ttf) or convert fonts to outlines when sending ANY Illustrator file, saved as AI, EPS or PDF.

### The following formats are NOT acceptable

- Publisher (.pub) • CorelDraw (.cdr) • small GIF or BMP internet images • low resolution JPG
- Any Word or spreadsheet documents - '.docx', '.xls', '.wpd', '.od'

If unsure about any format including "what is a vector" please send all inquiries to your inside Customer Service Rep

## OTHER PRINTING COSTS

**Artwork Charges:** As mentioned above, we have a talented creative team that can work with you to design, create, manipulate or re-size your store logo or name. Artwork service is charged at a rate of \$75.00/hour, min. 1/2 hour.

**Set-up Charges:** Every print job requires a machine to be set-up. A charge will be applied to every order. Foil, Ink, Pad and Digital printing is charged at \$37.00. Silk Screen printing is \$75. Please note: multiple print sizes of the same logo require multiple set-ups.

**Plate Charges:** Plate charges apply one-time only. Each time you require a 'new' print design (i.e. Logo change, Print Size Adjustment etc.) a new plate must be created. Once the plate is made, we will hold it for you in our warehouse and it will be available for all future printing requirements. Plate charges range in cost from \$94.00 for a Foil Printing plate to \$137.50+ for an Ink Printing Plate. (maximum 25 square inches)

## FOIL STAMPING COLORS

### Metallic Options

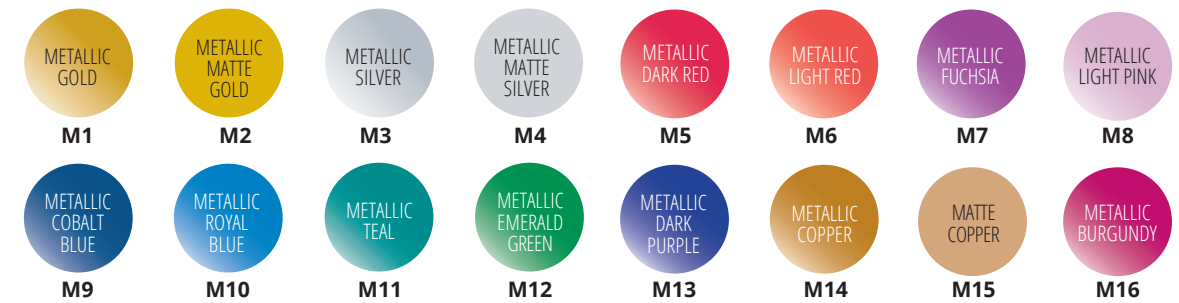

Metallic options feature a high sheen finish unless otherwise indicated as matte finish.

### Flat Options



### Pearlized Options

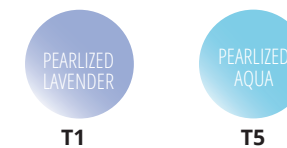

### Gloss Options

Gloss Clear - allows the color of the bag or box to show-through. Gives that tone on tone special highlighted look.



### Satine Foil Colors



## INK PRINTING COLORS

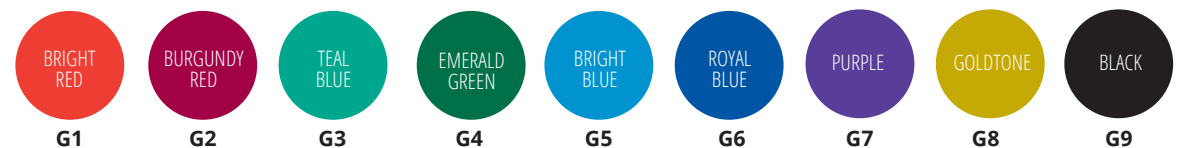

## PAD PRINTING COLORS

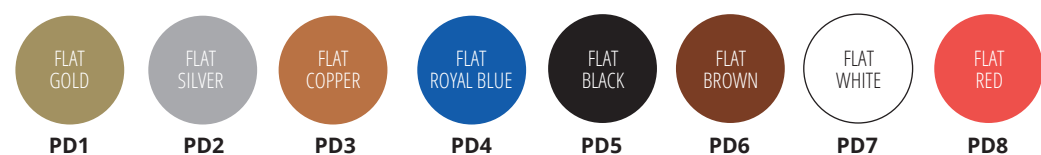

Colors shown are representations only and may not reflect true production colors.



**GUNTHERMELE** 1857  
 PACKAGE WITH PURPOSE

**TO PLACE AN ORDER**

Call Customer Service: 716.821.1472  
 Toll Free: 1.800.516.0108  
 Order on line: gunthermele.com  
 Direct Fax: 716.821.1480



**EASY PAYMENT OPTIONS**

- Online at: gunthermele.com and pay with your credit card
- Over the phone, by: Visa or Mastercard
- Contact head office to set up ACH

Sign up for paperless billing. See our website for more information.

**PROUD MEMBER**



**TERMS AND CONDITIONS:**

- Minimum order \$250.00.
- F.O.B point: Buffalo, NY USA
- Net 30 days O.A.C.
- New account payment terms: Visa or MasterCard 50% deposit with order, balance due upon shipping.
- Defective merchandise will be accepted back for credit only if claimed within 15 days of receipt of shipment. Authorization number must be obtained by contacting our customer service department 1.800.516.0108.
- In-transit damages and shortages must be claimed with the freight carrier at time of delivery.
- All lead times are estimates only (from receipt of approved artwork and credit) and are not guaranteed.
- Plate charges where applicable are:
  - Foil Print Dies: \$94.00 per size (maximum 30 square inches)
  - Pad Dies: \$104.50 per size (maximum 3.75 square inches)
  - Ink Plates \$137.50 (maximum 25 square inches)
- **While we strive for accuracy in our catalogue, actual product may be slightly different than pictured.**
- Prices subject to change without notice.