





## OUR VISION

“Helping our customers tell their unique brand story while providing a customer experience like no other.”

– Darrell King, President

**Welcome** to our new packaging guide – our 165th version since our founding in 1857. We have some exciting developments in the following pages. Most of the changes we have ushered in this year are centered around a more sustainable approach to our business with an emphasis on the materials we use and the reusability of our products. We have begun to view all of our products through this new lens of eco-minded sustainability. We call this our **“Mission Green”**.

Mission Green drives us to use materials that are either from recycled or sustainable sources. It also focuses us on a vastly overlooked practice in sustainability: reusability.



### RECYCLED

There are two important terms that classify the source of recycled content. These are: post-consumer waste and post-industrial waste. Post-consumer waste (PCW). Wherever possible, we are using paper and now plastics that are derived, at least partially if not fully, from municipal recycling programs and this term post-consumer implies that it has been recovered after consumer use. Post-industrial waste (PIW). Another key source of recycled material. In this instance, scrap material is diverted from the landfill and recycled into new material to be used in production. Product Examples include: our brand new, Canadian made paper twist shoppers made from paper that is derived from 96% post-consumer waste. Our new “resuede” is a luxurious recycled material that feels like plush suede but is produced using recycled materials to create a luxury look and feel. We feature our resuede material in our Drawer Series box (page 41) and our Eco Series of hinged boxes (page 33)

### SUSTAINABLE



FSC® – Forestry Stewardship Council®. In short, this governing body oversees wood and pulp (paper) products derived from responsibly managed forests. This global governing body is an intricate certification process that verifies paper and its sources. In the instances where paper needs to come from new pulp source, we are choosing to use papers that carry the widely recognized FSC designation.

### REUSABLE

Jewellery packaging has an inherent keepsake quality. Most people will collect jewellery boxes for storage and sentimental value. We have also been studying consumer behavior and there is demand for an after use of jewellery packaging. Our active lifestyles and thirst for travel dictates the need to store and protect jewelry when it is not being worn. With that, we have introduced our new Nano™ collection of luxurious and practical travel pouches that not only present the jewellery exquisitely but also doubles as ongoing storage and protection for our society who is always on the go.

In nearly every category we have exciting new products that meet our Mission Green criteria. These are just the first steps of our journey toward more sustainable and eco-conscious packaging solutions and we hope you'll join us on this important journey.

# NEW PRODUCT



**Richmond Series**  
Satin walnut  
See page 11



**Glitter Black**  
Glittery series  
See page 27



**Tux**  
Timeless classic  
See page 39



**Mystique Moonglow**  
See page 43



**Mystique Palladium**  
See page 43



**Eco-Lux Eurototes**  
See page 56



**Alpha**  
Style meets value  
See page 31



**Jewellers Velvet Sapphire**  
New sapphire colour  
See page 30



**Geo Platinum**  
New palladium colour  
See page 23



**Ultrasonic**  
Heat sealed and durable  
See page 68



**The Smart Bag**  
Reclaimed H2O bottles  
See page 69



**Rigid Collapsible**  
100% recyclable  
See page 74

# SPECIAL ORDER

Jewellery Display



# SPECIAL ORDER

Jewellery Display

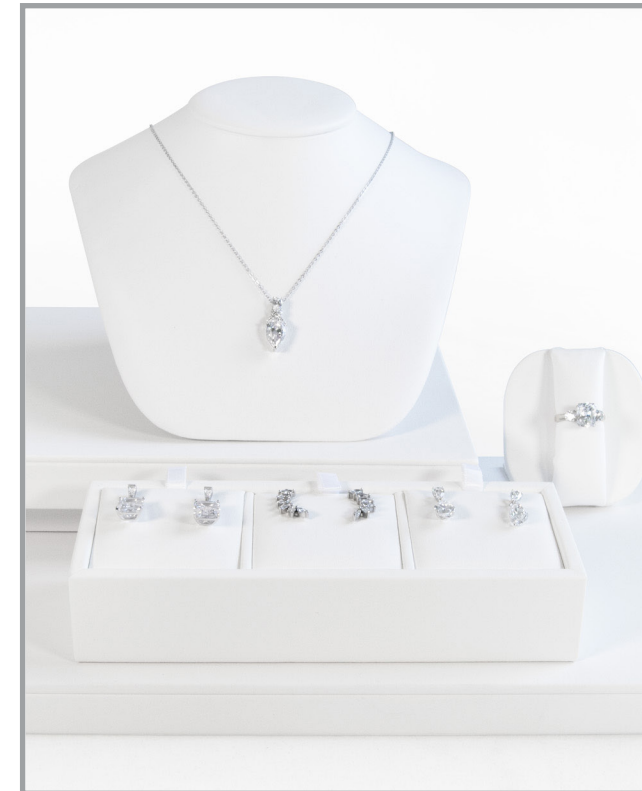

Platforms and Risers

Ring Showcase

Pendant & Earring Stands

Neck Forms & Bracelet Stands

Trays, Counter Pads,  
Chain Ramps

Open Stock and Prepacks  
Available

**Save 25% when you buy  
\$500 or more!**



Tell your brand story  
Create your unique identity

Elevate the  
shopping experience

Drive more sales

**Complimentary  
Display Design**

Financing Programs Available

\*Complete set of renderings available with payment of deposit.  
Deposits will be deducted from invoice at time of billing.



# TABLE OF CONTENTS

## Jewellery Packaging

Hinged Packaging .....	10 - 33	Horizon Series .....	32
<b>New</b> Richmond Wood Series .....	11	EcoBox <b>ECO</b> .....	33
Monterey II .....	13	Create Your Own Look Details .....	34 - 35
Signature Series .....	15	Jewellery Folders .....	36 and 37
Whisper .....	17	Paperboard Jewellery Packaging.....	38 - 43
Eclipse Series <b>ECO</b> .....	19	<b>New</b> Tux Series <b>ECO</b> .....	39
Estate Series .....	20	Deco Series <b>ECO</b> .....	40
Roma Series <b>ECO</b> .....	21	<b>ECO</b> The Drawer Box, Vision Box .....	41
<b>New</b> Geo Series (new colour) <b>ECO</b> .....	23	Royale Series .....	42
Geo Special Order .....	25	<b>New</b> Mystique Series <b>ECO</b> .....	43
Palladium Inlay .....	26	Nest Boxes <b>ECO</b> .....	44 - 45
<b>New</b> Glitter Black .....	27	Gift Card and Certificate Boxes .....	46 - 47
Vantage II <b>ECO</b> .....	29	Pouches .....	48 - 49
<b>New</b> Jewellers Velvet (new colour) .....	39	Jewellery Cloths and Cleaners .....	50 - 51
<b>New</b> Alpha Series .....	31	Repair Envelopes and Tags .....	52

## Bags

Vantage, Eclipse and Geo Eurototes .....	54	Paper Twist Handle & Damask <b>ECO</b> .....	63
Grosgrain Handle Eurototes .....	55	Merchandise Paper Bags <b>ECO</b> .....	64
<b>New</b> Eco-Lux Paper Eurototes <b>ECO</b> .....	56	Food Service Kraft Bags <b>ECO</b> .....	65
All Paper Eurototes <b>ECO</b> .....	57	<b>New</b> CYOL Jute and Cotton <b>ECO</b> .....	66 - 67
CYOL Rope Handle .....	58	<b>New</b> Ultrasonic Weld Reusable <b>ECO</b> .....	68
Manhattan Eurototes .....	59	<b>New</b> Smart Bag Reusable .....	69
5th Avenue Eurototes .....	60	Custom Full Colour Reusable .....	70
Special Order Tints and Pinstripe .....	60	In Stock Reusable Fabric Shoppers.....	71
<b>New</b> San Fran Natural Shoppers <b>ECO</b> .....	61	Garment Covers.....	94
CYOL Simply Paper Shoppers <b>ECO</b> .....	62		

## Gift Boxes and E-Commerce

<b>New</b> Rigid Collapsible <b>ECO</b> .....	74	CYOL E-Com Boxes and Mailers.....	78
White Folding Gift Boxes .....	75	In Stock E-Com Boxes for Gift & Apparel....	79
Apparel Boxes .....	75	In Stock E-Com Boxes for Jewellery .....	79
Malibu Magnetic Gift Box .....	76	In Stock and S/O E-Com Mailers .....	80
Tuckit® Boxes <b>ECO</b> .....	76		

## Finishing Touches

Inspirations Gift Wrap .....	82 - 83	Printed and Unprinted Ribbon .....	90 - 93
Special Order Gift wrap .....	84- 85	In Stock Seals - Foil Print .....	94 - 95
Special Order Jewellers Rolls .....	85	Custom Seals - Full Colour .....	96 - 97
Tissue Paper .....	86 - 87	Print Information & Print Colours....	98 - 99
Bows, Cellophane & Dispensers .....	88- 89		

# JEWELLERY PACKAGING



# CREATE YOUR OWN LOOK

# IN STOCK Hinged Boxes

JEWELLERY PACKAGING

JEWELLERY PACKAGING



**COORDINATING  
EUROTOTES**  
See pages 55

**New**

Outer Box

## Richmond ETA: Summer 2024

- Satin walnut
- Ivory brushed suedine pads and top liners
- Packaged in a black 2-piece outer box

CODE	DESCRIPTION	SIZE (inches)	PRICE /EACH	
			12+	144+
A 36521420	Ring (R1)	2.375 x 2.375 x 2	\$12.70	\$11.43
B 36522420	Earring (E1)	2.375 x 2.375 x 2	\$13.34	\$12.01
C 36583420	Utility T-pad (ET14)	4 x 4 x 2	\$22.23	\$20.01
D 36550420	Pillow (PL1)	4.375 x 4.375 x 2.75	\$28.80	\$25.92
E 36593420	Bracelet (BL1)	9.5 x 2.375 x 1.5	\$25.81	\$23.23
F 36573420	Necklace (N1)	7.5 x 7.5 x 2	\$40.31	\$36.28

SCAN THIS CODE ON  
YOUR PHONE TO ORDER



## WOOD SERIES

The possibilities are endless when you choose wooden materials. Endless and timeless, in terms of size, shape, finish and colour. High-end style, this collection features our Monterey series shape with a high gloss white finish, black "reveal" edge and black linea interior. Add a matching custom tote bag to complete the look.



### FOIL / PAD PRINT

F: inside liner and packer lid / PP: inside top liner and packer lid  
 12+ 35¢ each  
 144+ 32¢ each  
 504+ 26¢ each

Minimum 12 per style.  
Please allow 2 - 3 weeks for printed items from approved art.

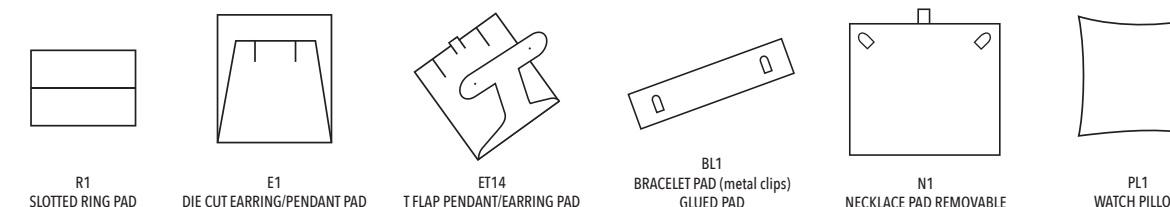

# CREATE YOUR OWN LOOK

# IN STOCK Hinged Boxes

JEWELLERY PACKAGING

JEWELLERY PACKAGING



**COORDINATING  
EUROTOTES**  
See pages 55

Available Colours



Outer Box  
**150MC - Black Gloss**



Outer Box  
**320M - Mahogany**



**150MCB -  
OPTIONAL  
BLACK INTERIOR  
RING BOX ONLY**

## Monterey II

Wood series with modern lines and a gloss finish.

- Soft white leatherette interior
- Packaged in a 2-piece white traditional outer box

CODE	DESCRIPTION	SIZE (inches)	PRICE/EACH	
			12+	144+
A 36821	Ring (R1)	2.375 x 2.375 x 2	\$12.38	\$10.12
B 36822	Earring (E1)	2.375 x 2.375 x 2	\$12.38	\$10.12
C 36843	Utility T-pad (ET14)	4 x 4 x 2	\$18.69	\$16.60
D 36850	Pillow (PL1)	4.375 x 4.375 x 2.75	\$24.00	\$20.18
E 36893	Bracelet (BL1R)	9.5 x 2.375 x 1.5	\$27.88	\$23.30
F 36813	Necklace (N1)	7.5 x 7.5 x 2	\$40.14	\$31.02

SCAN THIS CODE ON  
YOUR PHONE TO ORDER



## WOOD SERIES

The possibilities are endless when you choose wooden materials. Endless and timeless, in terms of size, shape, finish and colour. High-end style, this collection features our Monterey series shape with a high gloss white finish, black "reveal" edge and black linea interior. Add a matching custom tote bag to complete the look.

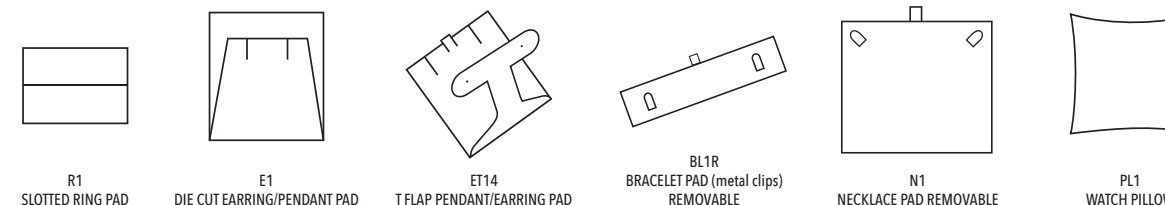

### FOIL / PAD PRINT

F: inside liner and packer lid / PP: all 3 locations  
12+ 35¢ each  
144+ 32¢ each  
504+ 26¢ each

Minimum 12 per style.  
Please allow 2 - 3 weeks for printed items from approved art.

All print orders subject to set-up charges. Applicable artwork, and plate charges may apply. See page 98.

# CREATE YOUR OWN LOOK

# IN STOCK Hinged Boxes

JEWELLERY PACKAGING

JEWELLERY PACKAGING



## Signature Series

This modernized classic is a must have.

- Plush black velvet hinged boxes accented with suede pads and bengaline trim detail
- Packaged in a coordinating 2-piece outer box

CODE	DESCRIPTION	SIZE (inches)	PRICE/EACH	
			12+	144+
A 36521151	Ring (R1)	1.96 x 1.96 x 1.96	\$9.72	\$8.56
B 36522151	Pendant/Earring (E1)	2.36 x 2.36 x 2.28	\$12.11	\$9.87
C 36583151	Utility (empty)	3.93 x 3.93 x 2.36	\$13.26	\$11.66
C1 69550151	Pillow (PL1)	fits utility box	\$3.31	\$2.92
C2 69583151	Triple Flip Pad (T3)	fits utility box	\$3.31	\$2.92
D 36573151	Necklace (N3)	7 x 7 x 1.77	\$21.41	\$18.84

SCAN THIS CODE ON  
YOUR PHONE TO ORDER

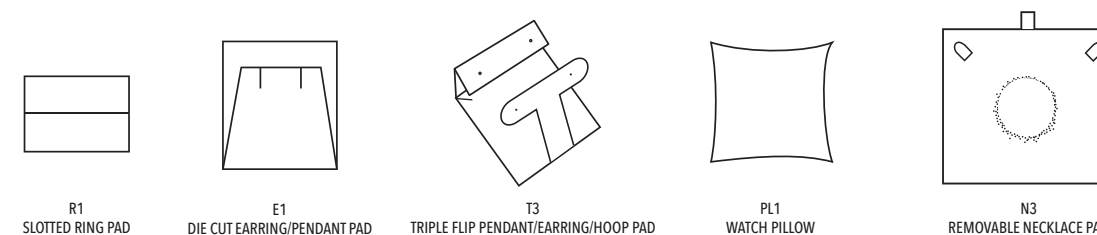

## VELVET SERIES

Plush velvet hinged boxes accented with suede pads and bengaline trim detail.

**FOIL / PAD PRINT**  
F / PP: inside liner and packer lid  
12+ 35¢ each  
144+ 32¢ each  
504+ 26¢ each

Minimum 12 per style.  
Please allow 2 - 3 weeks for printed items from approved art.

All print orders subject to set-up charges. Applicable artwork, and plate charges may apply. See page 98.

# CREATE YOUR OWN LOOK

# IN STOCK Hinged Boxes

JEWELLERY PACKAGING

JEWELLERY PACKAGING



**COORDINATING  
EUROTOTE**  
See page 59

Available Colours



559W - Carbon Black

009W - Moon Glow

289W - Palladium

## Whisper

Elegant curves and round corners.

- Monochromatic metallic pinsketch linea fabric
- Packaged in a coordinating 2-piece outer box

CODE	DESCRIPTION	SIZE (inches)	PRICE/EACH	
			12+	144+
A 36821	Ring (R1)	2.375 x 2.375 x 2.125	\$8.68	\$7.58
B 36822	Earring (E1)	2.375 x 2.375 x 2.125	\$8.68	\$7.58
C 36823	Large Ring (R1)	3.25 x 3.25 x 2.25	\$11.68	\$10.11
D 36883	Utility T-pad (ET14)	3.25 x 3.25 x 2.25	\$11.68	\$10.11
E 36850	Pillow (PL1)	4 x 4 x 2.75	\$15.78	\$13.74
F 36893	Bracelet (BL1)	9.25 x 2.5 x 1.75	\$15.57	\$13.60
G 36873	Necklace (N3)	6.5 x 8 x 1.75	\$24.34	\$19.99

SCAN THIS CODE ON  
YOUR PHONE TO ORDER

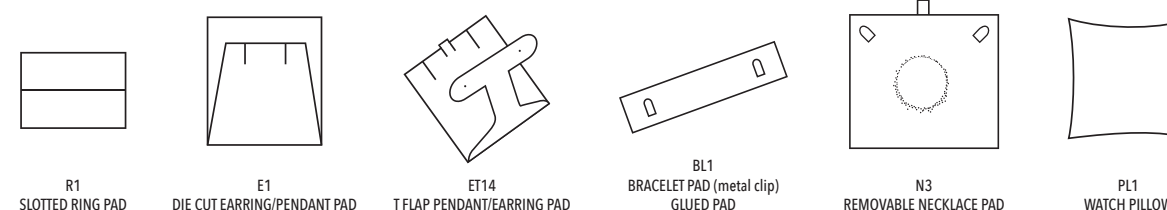

## WHISPER SERIES

Our modern luxury box is shown here in a stylish textured gold paper called: Shuttle. Matching texture, the interior and pads create a seamless look.



### FOIL / PAD PRINT

F: inside liner and packer lid / PP: all 3 locations  
12+ 35¢ each  
144+ 32¢ each  
504+ 26¢ each

Minimum 12 per style.  
Please allow 2 - 3 weeks for printed items from approved art.

All print orders subject to set-up charges. Applicable artwork, and plate charges may apply. See page 98.

# CREATE YOUR OWN LOOK

# IN STOCK Hinged Boxes

JEWELLERY PACKAGING

JEWELLERY PACKAGING



## ECLIPSE SERIES

This eclipse collection features an elegant champagne custom embossed covering with an ivory shimmer interior and gold printed logo on the top liner. The custom rope handle tote completes this beautiful collection.



**COORDINATING EUROTOTE**  
See page 56

Available Colours



813 - Linea Blue Celestial



663 - Linea Aubergine



423 - Brown

## Eclipse

Classic square corners with a distinctive crescent style front.

- Linea Aubergine and Linea Blue Celestial coverings with Ivory Shimmer satin top liners and pads. Packaged in coordinating full-depth 2-piece outer box
- Rich Brown leatherette covering with Champagne satin top liners and sueded pads. Packaged in white full-depth 2-piece outer box

CODE	DESCRIPTION	SIZE (inches)	AUBERGINE AND BLUE PRICE/EACH		BROWN PRICE/EACH	
			12+	144+	12+	144+
A 36821	Ring (R1)	2.5 x 2.5 x 1.75	\$9.10	\$7.93	\$7.59	\$6.04
B 36822	Earring/Pendant (E1)	2.5 x 2.5 x 1.75	\$9.10	\$7.93	\$7.59	\$6.04
C 36883	Utility T-pad (ET14)	3.75 x 4 x 1.75	\$13.67	\$12.13	\$10.00	\$8.55
D 36893	Bracelet (BL1R)	9.25 x 2.5 x 1.75	\$17.23	\$15.14	\$12.76	\$10.44
E 36873	Necklace (N2)	6.5 x 8 x 1.75	\$28.18	\$23.21	\$24.81	\$20.83
F 36850	Pillow (PL1)	3.75 x 4.25 x 3	\$18.14	\$15.84	\$13.55	\$11.14

SCAN THIS CODE ON YOUR PHONE TO ORDER

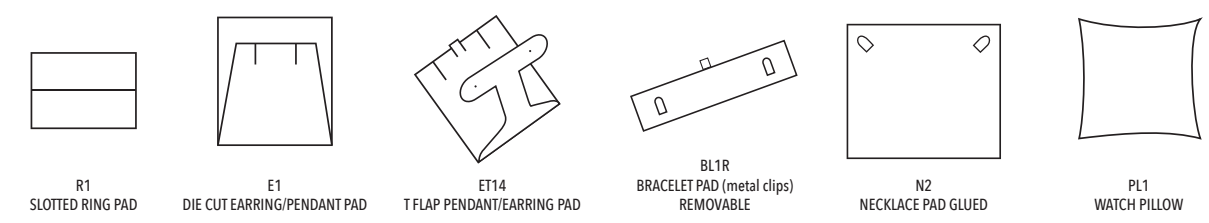

**FOIL / PAD PRINT**  
F: inside liner and packer lid / PP: all 3 locations  
12+ 35¢ each  
144+ 32¢ each  
504+ 26¢ each

Minimum 12 per style.  
Please allow 2 - 3 weeks for printed items from approved art.

All print orders subject to set-up charges. Applicable artwork, and plate charges may apply. See page 98.

# IN STOCK

## Hinged Boxes

JEWELLERY PACKAGING



**COORDINATING EUROTOTE**  
See pages 56



Available Colours



674 - Green

Outer Box

114 - Blue

Outer Box

153 - Black

Outer Box

**New**

**NEW Black**  
Estimated time of arrival  
Summer 2024

SCAN THIS CODE ON YOUR PHONE TO ORDER



## Estate

Contemporary style with a touch of tradition.

- White velvet pads and satin top liners
- Packaged in a coordinating 2-piece outer box

CODE	DESCRIPTION	SIZE (inches)	PRICE/EACH	
			12+	144+
A 36021 ___	Ring (R1)	2 x 2.25 x 1.875	\$6.94	\$5.50
B 36022 ___	Earring (E1)	2 x 2.125 x 1.625	\$6.72	\$5.36
C 36084 ___	Utility T-pad (ET14)	3.5 x 3.5 x 1.5	\$8.70	\$7.09
D 36093 ___	Bracelet (BL1R)	8.5 x 2.125 x 1	\$14.95	\$11.99
E 36073 ___	Necklace (N3)	7.125 x 4.375 x 1.25	\$21.25	\$17.02



**FOIL / PAD PRINT**  
F: inside liner and packer lid / PP: all 3 locations  
12+ 35¢ each  
144+ 32¢ each  
504+ 26¢ each

Minimum 12 per style.  
Please allow 2 - 3 weeks for printed items from approved art.



# IN STOCK

## Hinged Boxes

JEWELLERY PACKAGING



**COORDINATING EUROTOTE**  
See page 56



50% Recycled Shell

**BLACK INTERIOR OPTION 153B - Black on Black**

**WHITE INTERIOR OPTION 153 - White on Black**



Outer Box

## Roma

Distinctive round corner styling with sculpted sides.

- Lizard style embossed covering with leatherette interior
- Packaged in a 2-piece coordinating outer box with ¼ depth lids

CODE	DESCRIPTION	SIZE (inches)	PRICE/EACH	
			12+	144+
A 36421 ___	Ring (R1)	2.25 x 2.25 x 1.75	\$6.66	\$5.40
B 36422 ___	Earring (E1)	2.25 x 2.25 x 1.75	\$6.66	\$5.40
C 36484 ___	Utility T-pad (ET14)	3.75 x 3.75 x 2	\$8.80	\$7.51
D 36493 ___	Bracelet (BL1R)	9.375 x 2.25 x 1.5	\$11.63	\$9.97
E 36477 ___	Necklace (N3)	7.5 x 7.5 x 2.125	\$24.23	\$20.39



**FOIL / PAD PRINT**  
F: inside liner and packer lid / PP: all 3 locations  
12+ 35¢ each  
144+ 32¢ each  
504+ 26¢ each

Minimum 12 per style.  
Please allow 2 - 3 weeks for printed items from approved art.



SCAN THIS CODE ON YOUR PHONE TO ORDER



# CREATE YOUR OWN LOOK



## GEO SERIES

A series completely unique with added top stitching to the covering and upgrading the fabric to a luxurious grey leatherette. This Geo collection features a debossed logo on the top of the lid. Matching dark interior pads create a seamless look to showcase fine pieces. Packaged in two-tone 3/4 depth outer box with a silver embossed print. This collection is completed with coordinating custom rope handle totes.

# IN STOCK

## Hinged Boxes



### E-Commerce Jewellery Boxes

Deliver the 'in-store' experience to your customer's door.  
See page 79 for more information

**COORDINATING EUROTOTE**  
See page 54



Available Colours



873B - Bronze



563P - Purple



153B - Black



083P - Platinum\*



415B - Black Packer with Ivory Pouch  
456P - Purple Packer with Ivory Pouch  
427T - Bronze Packer with Ivory Pouch

### Geo

Modern texture in a choice of 4 colour options.

- Ivory brushed leatherette pads and satin top liners
- Packaged in a coordinating 3/4 depth 2-piece outer box

CODE	DESCRIPTION	SIZE (inches)	PRICE/EACH	
			12+	144+
A 36221	Ring/Earring (R1)	2.375 x 2.375 x 2.375	\$6.05	\$4.95
B 36283	T-pad Pendant (ET14)	3.5 x 4.5 x 1.5	\$7.20	\$6.21
C 36293	Bracelet (BL1R)	9 x 2.375 x 1.5	\$9.45	\$8.03
D 36273	Necklace (N3)	7 x 7 x 1.5	\$15.09	\$13.05
E 36220	Proposal Box* (R2)	2.36 x 2.36 x .94	\$4.21	\$3.68
F 36224	Lighted Ring/Earring* (R1)	2.36 x 2.36 x 2.36	\$15.20	\$13.32
G 09030	Pouch with Box*	3 x 4	\$2.91	\$2.47
69221100G	Earring Pad to fit Ring/Earring box (E8)		\$1.03	

\* not available in Platinum

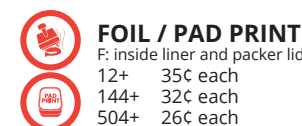
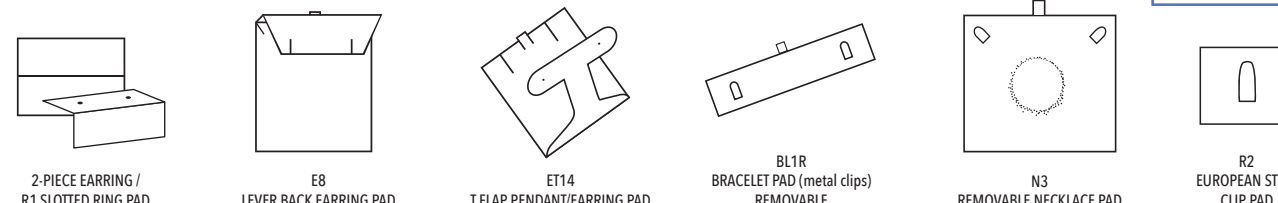

**FOIL / PAD PRINT**  
F: inside liner and packer lid / PP: all 3 locations  
12+ 35¢ each  
144+ 32¢ each  
504+ 26¢ each

Minimum 12 per style.  
Please allow 2 - 3 weeks for printed items from approved art.

All print orders subject to set-up charges. Applicable artwork, and plate charges may apply. See page 98.

# SPECIAL ORDER

## Geo Series Boxes and Bags

JEWELLERY PACKAGING



Available in 16 colours  
in a selection of 4 luxurious  
textured papers.



Shown in Celestial Blue

Shown in Moss

Shown in Brick

Contact your representative for assistance  
selecting your texture and colour.

# SPECIAL ORDER

## Geo Series Boxes and Bags

JEWELLERY PACKAGING

### 16 Colour Options Available



### 4 Texture Paper Options Available

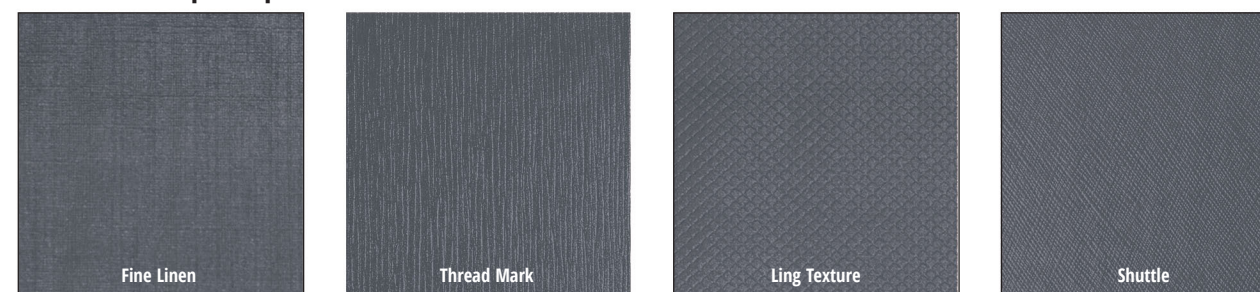

### Geo Hinged Packaging

- Ivory brushed leatherette pads and satin top liners
- Packaged in a coordinating ¾ depth 2-piece outer box

DESCRIPTION	SIZE (inches)	PRICE/EACH
Ring/Earring (R1)	2.375 x 2.375 x 2.375	\$5.70
T-pad Pendant (ET14)	3.5 x 4.5 x 1.5	\$6.64
Bracelet (BL1R)	9 x 2.375 x 1.5	\$7.77
Necklace (N3)	7 x 7 x 1.5	\$11.38
Proposal Box (R2)	2.36 x 2.36 x .94	\$4.53

**FOIL PRINT - INCLUDED IN PRICE**  
Inside Top Liner  
Packer Lid

Boxes: Minimum 1500 assorted. (min 100 per box)  
Bags: Minimum 1000 each size with purchase of 1500 boxes.  
Estimated lead time: 12 - 14 weeks for printed items from approved art.

### Geo Eurototes

- 110 gsm uncoated paper with 8mm rope handles
- Foil printed two sides

SIZE (inches)	PRICE/EACH
6 x 3.5 x 6 x 3.5	\$1.47
9 x 3.5 x 7 x 3.5	\$1.76
10.5 x 5 x 8.5 x 5	\$2.16

**FOIL PRINT**  
INCLUDED IN PRICE

Bags Only: Minimum 3000 each size.  
Estimated lead time: 12 - 14 weeks for printed items from approved art.

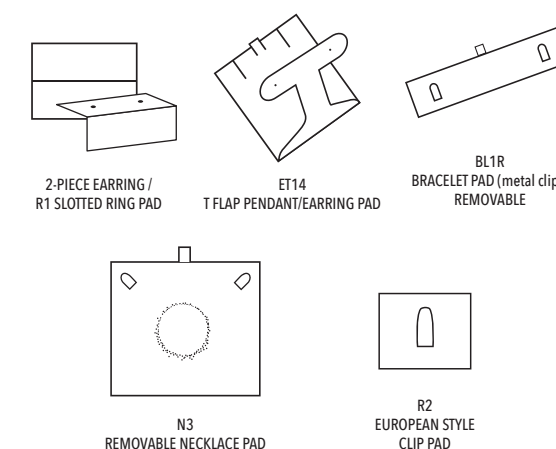

## Our Top Selling Collection Just Got Even Better!

Printing included for  
any of the items in this program.

Choice of Matte or Metallic Foil Print:  
Gold, Silver, Copper or Black.

All print orders subject to set-up charges. Applicable artwork, and plate charges may apply. See page 98.

# IN STOCK

## Hinged Boxes

JEWELLERY PACKAGING



**COORDINATING  
EUROTOTE**  
See page 55

### Palladium Inlay

Stylish contemporary series.

- Palladium grey brushed exterior
- Cream pads and top liner with matching exterior edge
- Packaged in a coordinating 2-piece outer box

CODE	DESCRIPTION	SIZE (inches)	PRICE/EACH	
			12+	144+
A 36221283P	Ring (R1)	2.25 x 2 x 1.75	\$6.32	\$5.19
B 36222283P	Earring (E1)	2.25 x 2 x 1.75	\$6.32	\$5.19
C 36283283P	Utility T-pad (ET14)	3.18 x 4.17 x 1.41	\$8.91	\$7.57
D 36293283P	Bracelet (BL1)	8.6 x 2.16 x 1	\$10.24	\$8.58
E 36273283P	Necklace (N2)	6.25 x 4.4 x 1.41	\$12.23	\$10.31

SCAN THIS CODE ON  
YOUR PHONE TO ORDER



#### FOIL / PAD PRINT

F: inside liner and packer lid / PP: all 3 locations  
12+ 35¢ each  
144+ 32¢ each  
504+ 26¢ each

Minimum 12 per style.  
Please allow 2 - 3 weeks for printed items from approved art.



# IN STOCK

## Hinged Boxes

JEWELLERY PACKAGING



**COORDINATING  
EUROTOTE**  
See page 57



### Glitter Black

Sparkle and shine with this great glittering series.

- Black faux suede pads and satin top liners
- Packaged in individual black sleeves

CODE	DESCRIPTION	SIZE (inches)	PRICE/EACH	
			12+	144+
A 36221183GB	Ring (R1)	1.75 x 2 x 1.5	\$2.77	\$2.44
B 36222183GB	Earring (E1)	1.75 x 2 x 1.5	\$2.77	\$2.44
C 36284183GB	Utility T-pad (ET14)	3.5 x 3.5 x 1.25	\$4.67	\$4.12
D 36293183GB	Bracelet (BL1)	8.75 x 2.125 x 1	\$6.02	\$5.29
E 36273183GB	Necklace (N2)	6.25 x 4.25 x 1.25	\$7.67	\$6.74

SCAN THIS CODE ON  
YOUR PHONE TO ORDER



#### FOIL / PAD PRINT

F: inside liner / PP: inside top liner and box lid  
12+ 35¢ each  
144+ 32¢ each  
504+ 26¢ each

Minimum 12 per style.  
Please allow 2 - 3 weeks for printed items from approved art.



# CREATE YOUR OWN LOOK

# IN STOCK Hinged Boxes



**COORDINATING EUROTOTE**  
See below and on page 54

Available Colours

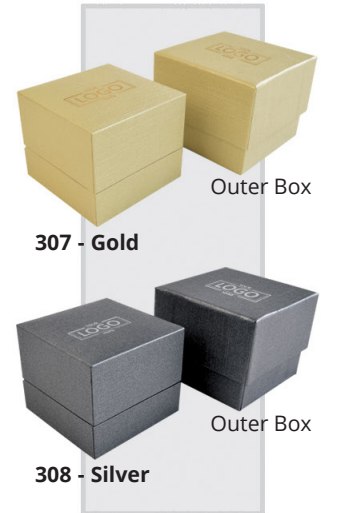

## Vantage II

Elegant gold or silver in a linen embossed pattern.

- White satin top liners and leatherette bottom pads
- Packaged in a coordinating 3/4 depth lid 2-piece outer box

CODE	DESCRIPTION	SIZE (inches)	PRICE/EACH	
			12+	144+
A 36221	Ring/Earring (R1/E8)	2 x 2 x 1.625	\$5.15	\$4.37
B 36232	T-Pad Pendant (ET14)	2.64 x 2.72 x 2.165	\$6.18	\$5.25
C 36284	Utility T-pad (ET14)	3.5 x 3.5 x 2	\$7.50	\$6.37
D 36293	Bracelet (BL1)	8.625 x 2.125 x 1.25	\$10.23	\$8.69
E 36273	Necklace (N2)	6.25 x 4.5 x 1.5	\$12.85	\$10.91

**FOIL / PAD PRINT**  
F: inside liner and packer lid / PP: all 3 locations  
12+ 35¢ each  
144+ 32¢ each  
504+ 26¢ each

Minimum 12 per style.  
Please allow 2 - 3 weeks for printed items from approved art.

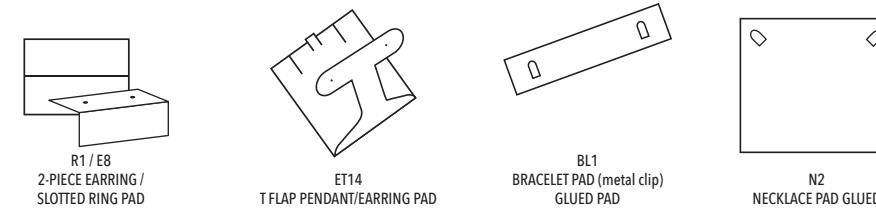

## VANTAGE SERIES

6 pieces - 2 boxes + 4 inserts + 9 presentations. A streamlined and customized assortment.



## Coordinating Eurototes

- 150 gsm uncoated paper with 8mm paper cord handles
- Minimum 100 per colour

CODE	SIZE (inches)	PRICE/EACH		
		100+	500+	1000+
230606	6 x 3.5 x 6 x 3.5	\$1.28	\$1.17	\$1.01
231008	10.5 x 5 x 8.5 x 5	\$1.63	\$1.46	\$1.25

07V - Gold



08V - Silver



**FOIL PRINT**  
100+ 35¢ each  
1000+ 32¢ each  
2500+ 26¢ each

Estimated lead time: 2 - 3 weeks for printed items from approved art.



All print orders subject to set-up charges. Applicable artwork, and plate charges may apply. See page 98.

# IN STOCK

## Hinged Boxes

COORDINATING EUROTOTE  
See page 56



Available Colours



### Jewellers Velvet

Lasting traditions.

- Satin top liners
- Packaged in a white 2-piece outer box

CODE	DESCRIPTION	SIZE (inches)	12+	144+
A 36121	Ring (R1)	2 x 2.125 x 1.5	\$3.69	\$2.87
B 36141	Double Ring (R1)	2.5 x 2 x 1.5	\$4.32	\$3.35
C 36122	Earring (E2)	2 x 2.125 x 1.5	\$3.69	\$2.87
D 36132	Utility T-pad (ET14)	2.5 x 2.5 x 1.25	\$4.45	\$3.48
E 36163	Pendant (E1)	2.25 x 3 x 1.125	\$4.96	\$3.73
F 36183	Utility (EP4)	3.5 x 3.375 x 1.5	\$6.84	\$5.37
G 36193	Bracelet (BL1)	8 x 2 x 1.25	\$7.58	\$5.88
H 36173	Necklace (N2)	7 x 4.25 x 1.5	\$11.58	\$9.16

SCAN THIS CODE ON YOUR PHONE TO ORDER

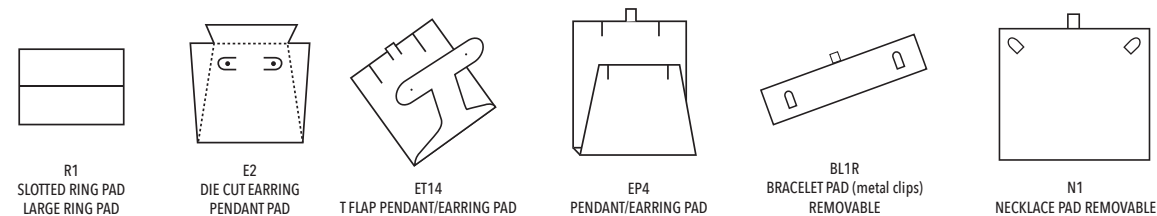

#### FOIL / PAD PRINT

F: inside liner and packer lid / PP: inside top liner and packer lid  
12+ 35¢ each  
144+ 32¢ each  
504+ 26¢ each

Minimum 12 per style.  
Please allow 2 - 3 weeks for printed items from approved art.



# IN STOCK

## Hinged Box

COORDINATING EUROTOTE  
See page 54



### Alpha

Style meets value.

- Soft white leatherette and top liners
- Packaged in a white 2-piece outer box

CODE	DESCRIPTION	SIZE (inches)	PRICE / EACH	
			12+	144+
A 36621002	Ring (R1)	1.875 x 2.125 x 1.375	\$2.96	\$2.66
B 36641002	Double Ring (R1)	2.375 x 2 x 1.5	\$3.28	\$2.95
C 36622002	Earring (E2)	1.875 x 2.125 x 1.375	\$2.83	\$2.55
D 36663002	Pendant (EP4)	2.25 x 3 x 1.125	\$3.92	\$3.53
E 36632002	T-pad Pendant (ET14)	2.5 x 2.5 x 1.25	\$3.43	\$3.09
F 36683002	Utility (EP4)	3.875 x 3.25 x 1.375	\$5.44	\$4.89
G 36693002	Bracelet (BL1)	8 x 2.125 x 1	\$5.85	\$5.27
H 36673002	Necklace (N1)	7 x 4.25 x 1.375	\$8.60	\$7.74

SCAN THIS CODE ON YOUR PHONE TO ORDER

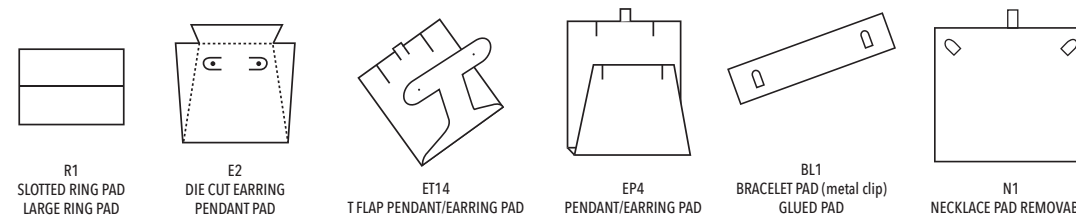

#### FOIL / PAD PRINT

F: inside liner and packer lid / PP: inside top liner and packer lid  
12+ 35¢ each  
144+ 32¢ each  
504+ 26¢ each

Minimum 12 per style.  
Please allow 2 - 3 weeks for printed items from approved art.



# IN STOCK

## Hinged Boxes

**COORDINATING EUROTOTE**  
See page 56



### E-Commerce Jewellery Boxes

Deliver the 'in-store' experience to your customer's door.  
See page 79 for more information



Available Colours



003 - White

663 - Burgundy

153 - Black

## Horizon

The gold standard in a classic white, burgundy and black.

- White velour pads and satin top liners
- Packaged in a white traditional 2-piece outer box

CODE	DESCRIPTION	SIZE (inches)	12+	144+
A 36621 ___	Ring (R1)	2.125 x 2 x 2	\$3.92	\$3.06
B 36622 ___	Earring (E1)	2.125 x 2 x 2	\$3.92	\$3.06
C 36641 ___	Double Ring (R1)	3 x 2 x 2	\$4.48	\$3.65
D 36684 ___	Utility T-pad (ET14)	3.5 x 3.5 x 1.5	\$5.65	\$4.52
E 36632 ___	T-Pad Pendant (ET14)	2.75 x 2.75 x 1.375	\$5.59	\$4.38
F 36693 ___	Bracelet (BL1)	8.25 x 2.125 x 1.25	\$7.38	\$6.00
G 36673 ___	Necklace (N2)	6.25 x 5 x 1.5	\$11.58	\$9.09
H 36650 ___	Bangle (R1)	1 x 3.75 x 3.125	\$4.82	\$4.14
I 69621000B	Bead Pad for earring box		\$0.68	\$0.56

### BLACK PADS AVAILABLE (3 SIZES)

J 36621153B	Single Ring Pad (black)	2.125 X 2	box w/pad	\$3.92	\$3.06
69622153B	Stud Earring Pad (black)	2.125 x 2	pad only	\$0.34	\$0.34
69633153B	Pend/Earring Pad (black)	2.75 x 2.75	pad only	\$1.09	\$1.09



### Bead Pad

- pad fits stud earring box
- ribbon threads through bead
- ribbon wraps to back and is held by clip



**FOIL / PAD PRINT**  
F: inside liner and packer lid / PP: all 3 locations  
12+ 35¢ each  
144+ 32¢ each  
504+ 26¢ each

Minimum 12 per style.  
Please allow 2 - 3 weeks for printed items from approved art.

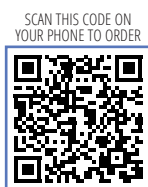

# IN STOCK

## Hinged Box

**COORDINATING ALL PAPER EUROTOTE**  
See page 57



Outer Sleeve

## EcoBox

Modern look inside and out.

- Gunther Mele Mission Green product
- Made with recycled paper exterior
- Made with 50% recycled material plastic shell
- Resuede interior material (49% recycled)



50% Recycled Shell

CODE	DESCRIPTION	SIZE (inches)	PRICE/EACH	
			12+	144+
A 36121000	Ring/Earring (R1)	2 x 2 x 1.5	\$4.93	\$4.18
B 36163000	T-Pad Pendant/Earring (ET14)	3.75 x 3.75 x 1.33	\$7.92	\$6.73
C 36193000	Bracelet (BL1)	8.5 x 2 x .91	\$6.97	\$5.92
D 36173000	Necklace (N3)	7 x 5 x 1.10	\$12.65	\$10.76

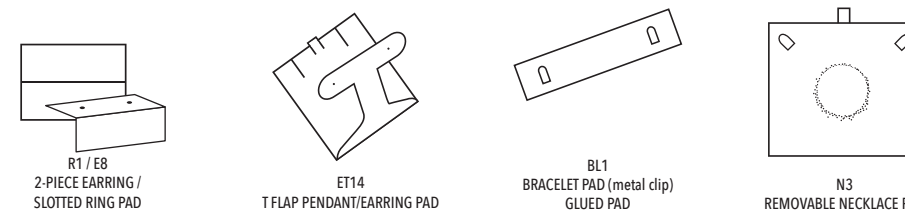

**FOIL / PAD PRINT**  
F: inside liner / PP: top lid  
12+ 35¢ each  
144+ 32¢ each  
504+ 26¢ each

Minimum 12 per style.  
Please allow 2 - 3 weeks for printed items from approved art.

# CREATE YOUR OWN LOOK

## TELL YOUR BRAND STORY CREATE YOUR UNIQUE IDENTITY



### Create Your Own Look in 7 Easy Steps

Speak to your sales representative for a consultation.

## Looking for 100% custom design? Design your very own jewellery packaging.

### STEP 1:

Choose your box style. We have access to endless design and looks. You dream it, we can create it. Choose from wood, plastic, MDF and paperboard shells. Select hinged or 2-piece. MOQ:  
Plastic or Metal 2,500  
Wood 1,000  
Paperboard 5,000

### STEP 2:

Choose your covering and colour. Leatherette, velvet, paper. Design your texture—hundreds to choose from, or create your own. Brushed leatherette, embossed papers, smooth, textured. Select from our colour books, or use Pantone to specify your exact colours.

### STEP 3:

Specify the interior. Select pad colour and material for inside lid. Leatherette, brushed leatherette, flocked, velvet, velour. Decide on the top interior material—leatherette, brushed leatherette, satin, flocked, velvet. Select colour—white, black, ivory are most common. Option—create a reveal with contrasting colour.

### STEP 4:

Design your packer. 2-piece box or sleeve. Often you can use the same material or create a coordinating colour. Option -- add die cuts at bottom for ribbon, and/or reveal for contrasting colour.



### STEP 5:

Design logo placement. Areas to consider:  
Inside box lid (Top Satin)  
Packer Lid (can be centered, or placed at lower corner if using ribbon)  
Top Lid



### STEP 6:

Select your pad designs. (See page 35)

### STEP 7:

Email your artwork. Artwork ultimately needs to be in Vector file format. Your graphic designers should be able to assist you. Gunther Mele is also available to provide artwork assistance and full service design, cost is \$75/hour, min half hour charge.

CYOL has 16-20 weeks lead time. (Time frames based on signed approved artwork, quote and deposit). Printing and pre-production samples included at no extra charge.

### Please note:

Logos with intricate lines and details (such as diamonds), often will not translate in small print areas, such as top satins. Designs with text and simple outlines work best for inside of ring boxes, etc. Reps and our designers will advise you when artwork should be modified to produce best results.

To ensure accuracy and best quality, signatures are required on all artwork documents and quote documents where noted. Production will not commence until all artwork, quotes and deposits are finalized and signed off. Your rep is available to work with you to ensure all documentation is completed to prevent delays. Please ensure your email access is update date.

## Complete your look!

Bags, Tissue, Pouches, Ribbon, Displays, Necklace folders, and more!

Select from our in stock or create your own. Gunther Mele is your one stop for all your needs.

Our sales representative can help you design all your packaging and displays to tell your unique brand story.

# CREATE YOUR OWN LOOK

## RING PADS

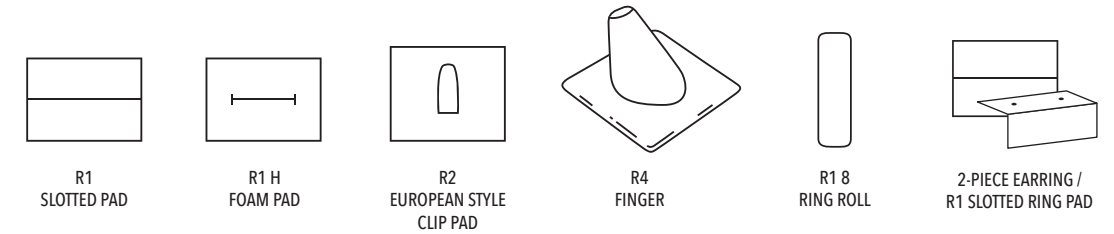

## EARRING PADS

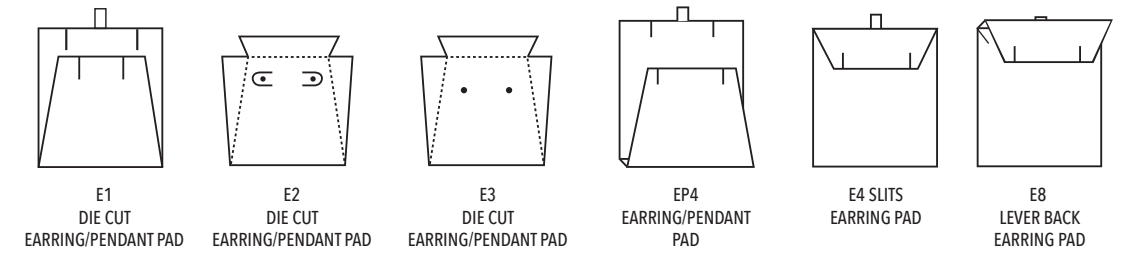

## EARRING/PENDANT PADS

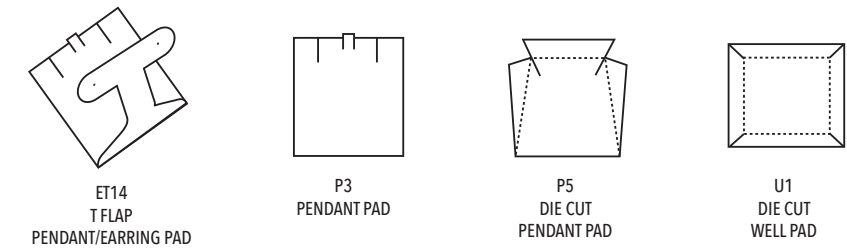

## BRACELET AND WATCH PADS

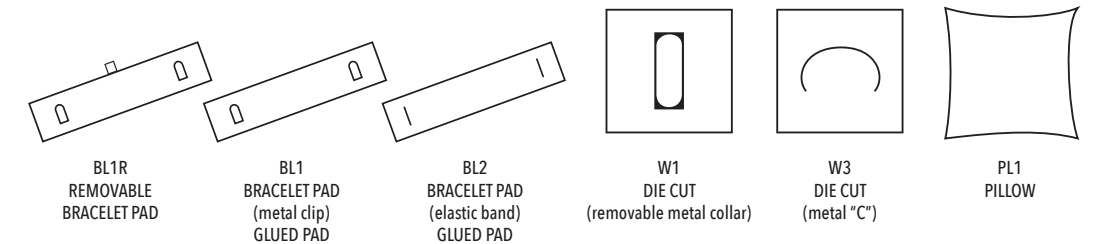

## NECKLACE PADS

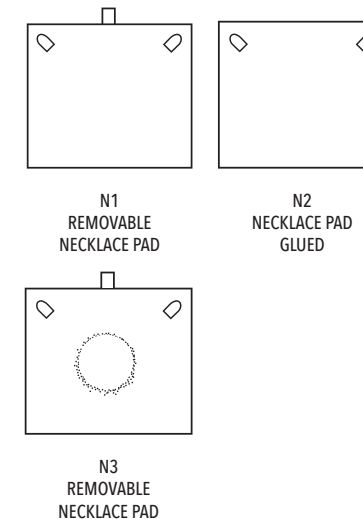

## TRIPLE FLIP PADS

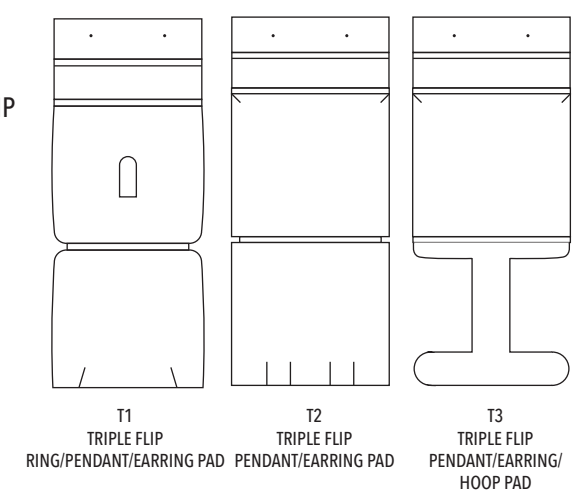

# IN STOCK

## Jewellery Packaging



### Nano Clutch

Perfect for gifting and on the go, this collection is going places!

- Linea envelope, and pad
- Packaged in a 2-piece matching outer box

CODE	DESCRIPTION	SIZE (inches)	PRICE/EACH	
			12+	144+
09121	Ring (R1)	2.55 X 2.55	\$2.49	\$2.30
09163	Pendant (P3)	4 X 4	\$3.04	\$2.80
09193	Bracelet (BL1R)	9.625 X 3.125	\$4.19	\$3.85
09173	Necklace (N1)	6.625 X 6.625	\$5.72	\$5.27

Available Colours



151C - Carbon Black

001M - Diamond White

SCAN THIS CODE ON YOUR PHONE TO ORDER

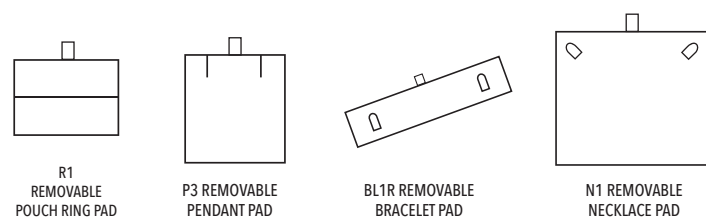

#### FOIL / PAD PRINT

F: outside flap and packer / PP: outside flap and packer  
 12+ 35c each  
 144+ 32c each  
 504+ 26c each

Minimum 12 per style.  
 Please allow 2 - 3 weeks for printed items from approved art.



See page 34.

# IN STOCK

## Jewellery Folders



### Passport Jewellery Folders

Designed with stylish envelope closure, snaps tight to keep jewels secure.

- Linea exteriors, satin interior
- Packaged in a 2-Piece white outer box
- Two colours soft white and black
- Case pack of 12

SCAN THIS CODE ON YOUR PHONE TO ORDER



CODE	DESCRIPTION	SIZE (inches)	12+	144+
367950	Bracelet	8.25 x 1.75	\$5.90	\$5.02
367900	Necklace/Pearl	6 x 8	\$9.83	\$8.40



#### FOIL / PAD PRINT

Bracelet: F and PP: inside bottom flap and packer lid  
 Necklace: PP: top flap / F and PP: inside flap and packer lid  
 12+ 35c each  
 144+ 32c each  
 504+ 26c each

Estimated lead time: 2 - 3 weeks for printed items from approved art.



### Global Jewellery Folders

Wide gusset folder for larger pieces.

- Bronze and pearl linea
- Packaged in a 2-Piece matching outer box
- Black faux suede
- Case pack of 12
- Satin interior and magnetic closure

CODE	SIZE (in.)	PRICE /EACH	
		12+	144+
36790	5.5 x 7.5	\$12.48	\$10.47



#### FOIL / PAD PRINT

PP: top flap / F and PP: inside flap and packer lid  
 12+ 35c each  
 144+ 32c each  
 504+ 26c each

Estimated lead time: 2 - 3 weeks for printed items from approved art.

SCAN THIS CODE ON YOUR PHONE TO ORDER



009P - Pearl

### Hoop Earring Folder

Black ultrasuede folder with top stitch finish and black interior. Holds hoop earrings up to 2.75" in diameter.

- Packaged in a white 2-Piece outer box
- Case pack of 12

CODE	SIZE (in.)	PRICE /EACH	
		12+	144+
36791015	4.5 x 4.5	\$4.60	\$3.96



#### FOIL / PAD PRINT

F: packer lid / PP: packer lid  
 12+ 35c each  
 144+ 32c each  
 504+ 26c each

Estimated lead time: 2 - 3 weeks for printed items from approved art.

SCAN THIS CODE ON YOUR PHONE TO ORDER



# CREATE YOUR OWN LOOK

# IN STOCK 2-Piece Boxes

JEWELLERY PACKAGING

JEWELLERY PACKAGING



COORDINATING  
ALL PAPER EUROTOTE  
See page 57

**New**

## Tux

**A timeless classic.**

- Black 2-piece boxes with white flocked foam pads
- Crisp white grosgrain ribbon
- Packaged in individual white sleeves

CODE	DESCRIPTION	SIZE (inches)	CASE PACK	PRICE/EACH	
				25+	500+
A 31521153	Ring (R1)	2.5 x 2.25 x 2	50	\$2.39	\$2.11
B 31583153	Utility (EP4)	3 x 3 x 2	50	\$3.31	\$2.91
C 31593153	Bracelet (BLR1)	9 x 2.25 x 1.5	50	\$4.55	\$4.00
D 31573153	Necklace (N1)	6.25 x 8 x 2	25	\$5.95	\$5.24

SCAN THIS CODE ON  
YOUR PHONE TO ORDER

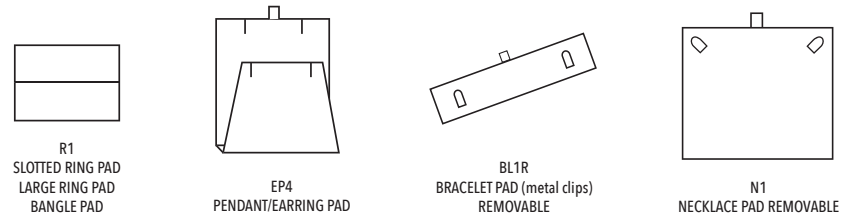

**FOIL / PAD PRINT**  
F: inside and top lid / PP: inside and top lid  
50/100+ 35¢ each  
1000+ 32¢ each  
2500+ 26¢ each

Minimum one case pack.  
Please allow 2 - 3 weeks for printed items from approved art.

All print orders subject to set-up charges. Applicable artwork, and plate charges may apply. See page 98.

All print orders subject to set-up charges. Applicable artwork, and plate charges may apply. See page 98.

# IN STOCK

## Paperboard Hinged

JEWELLERY PACKAGING



**COORDINATING EUROTOTE**  
See page 56



Outer Sleeve

Pads are removable and reversible. Choose white flock or black flock.



### Deco

Iconic black and white.

- Paperboard construction, covered in smooth laminate paper
- Flocked reversible black and white foam pads
- Packaged in individual white sleeves

CODE	DESCRIPTION	SIZE (inches)	CASE PACK	PRICE/EACH	
				50+	500+
A 31621153D	Ring (R1H)	2 x 2 x 1	50	\$1.68	\$1.42
B 31622153D	Earring (P3)	2 x 2 x 1	50	\$1.68	\$1.42
C 31632153D	Large Earring (P3)	2.5 x 2.5 x 1.75	50	\$2.18	\$1.85
D 31684153D	Utility (P2)	3.75 x 3.75 x 1.5	50	\$3.46	\$2.94
E 31693153D	Bracelet (BL1)	9 x 2 x 1.125	50	\$3.63	\$3.08
F 31673153D	Necklace (N2)	6.5 x 8 x 2	50	\$7.80	\$6.63

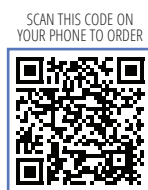

SCAN THIS CODE ON YOUR PHONE TO ORDER

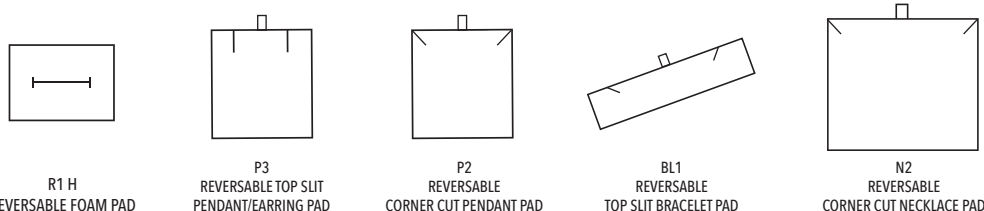

**FOIL / PAD PRINT**  
F: inside and top lid / PP: inside and top lid  
50+ 35¢ each  
500+ 32¢ each  
2500+ 26¢ each

Minimum one case pack.  
Please allow 2 - 3 weeks for printed items from approved art.



# IN STOCK

## Specialty

JEWELLERY PACKAGING



### The Drawer Box

Eco-friendly, on trend series.

- Removable resuede recycled pads
- Fixed ring pad with foam
- Made with 100% recycled paperboard
- Coordinates with the Nano Pouch for a stunning reveal (earring & pendant)



CODE	DESCRIPTION	SIZE (inches)	CASE PACK	PRICE/EACH	
				50+	500+
31050603	Ring (R1)	2.24 x 2.36 x 1.98	50	\$2.67	\$2.13
31070703	Earring Utility	2.75 x 2.83 x 1.57	50	\$3.07	\$2.46
31101003	Pendant Utility	3.93 x 4 x 1.57	50	\$4.01	\$3.21

SCAN THIS CODE ON YOUR PHONE TO ORDER



**PAD PRINT**  
PP: box top  
50+ 35¢ each  
500+ 32¢ each  
2500+ 26¢ each

Minimum one case pack.  
Please allow 2 - 3 weeks for printed items from approved art.

### Vision Box

Unique transparent 3D window box with coordinating display stand.

- Transparent puncture resistant elastic film
- Conforms to hold any jewellery piece
- Coordinating display base (extra)

CODE	DESCRIPTION	SIZE (inches)	PRICE/EACH	
			12+	144+
36301103	Small	2.68 x 2.68 x .75	\$1.19	\$0.95
36302103	Medium	3.5 x 3.5 x .75	\$1.59	\$1.27
36303103	Large	4.25 x 4.25 x .75	\$1.99	\$1.59
69300103	Base (pkg of 12)	2.25 x 2.25 x .62	\$0.99	\$0.73

SCAN THIS CODE ON YOUR PHONE TO ORDER



**PAD PRINT**  
PP: side of lid - text only - limited space  
12+ 35¢ each  
144+ 32¢ each  
504+ 26¢ each

Minimum 12 per style.  
Please allow 2 - 3 weeks for printed items from approved art.

All print orders subject to set-up charges. Applicable artwork, and plate charges may apply. See page 98.

# IN STOCK

## Paperboard Hinged

# IN STOCK

## 2-Piece Boxes

JEWELLERY PACKAGING

JEWELLERY PACKAGING



**COORDINATING EUROTOTE**  
See pages 56

### Royale

Hinged, white paperboard boxes covered in finely ribbed paper with gold accent lines.

- Texture paper wrapped hinged boxes with white flocked foam pads
- Match with Rope Handle Eurototes
- Packaged in individual white sleeves

CODE	DESCRIPTION	SIZE (inches)	CASE PACK	PRICE/EACH	
				50+	1000+
31545003	Ring/Earring (R1H)	2.5 x 2 x 1.5	100	\$1.47	\$1.34
31533003	Pendant/Earring (P2)	2.75 x 2.75 x 1	100	\$1.76	\$1.55
31560003	Utility (P3)	3.5 x 3.5 x 1	50	\$2.14	\$1.88
31580003	Bracelet (BL2)	8.125 x 2.125 x 1	50	\$2.76	\$2.48
31575003	Necklace (N1)	6.5 x 4.5 x 1	50	\$4.25	\$3.69

SCAN THIS CODE ON YOUR PHONE TO ORDER

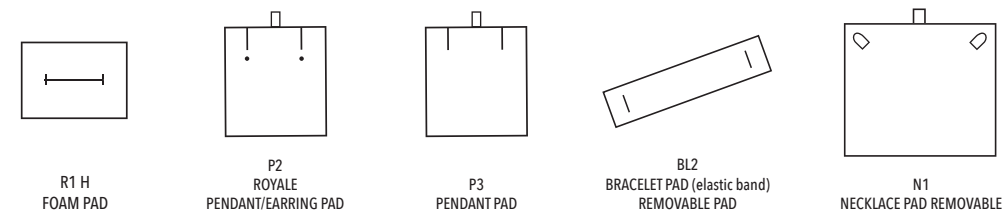

**FOIL / PAD PRINT**  
F: inside and top lid / PP: inside and top lid  
50/100+ 35c each  
1000+ 32c each  
2500+ 26c each

Minimum one case pack.  
Please allow 2 - 3 weeks for printed items from approved art.



**New**

Available Colours



Perfectly partners with our Whisper series. As shown here with the Moonglow hinged boxes.

### Mystique

- Texture paper wrapped 2-piece boxes with flocked foam pads
- Packaged in individual white sleeves

CODE	DESCRIPTION	SIZE (inches)	CASE PACK	PRICE/EACH	
				25+	500+
A 31221 ---	Ring (R1)	2.5 x 2.25 x 2	100	\$2.49	\$2.24
B 31222 ---	Earring (EP4)	2 x 1.5 x 1.187	100	\$1.91	\$1.72
C 31263 ---	Utility (P3)	3 x 3 x 2.125	100	\$2.82	\$2.54
D 31293 ---	Bracelet (BL1R)	9 x 2.375 x 1.5	50	\$4.06	\$3.65
E 31273 ---	Necklace (N1)	6.375 x 8 x 2	25	\$5.82	\$5.24

SCAN THIS CODE ON YOUR PHONE TO ORDER

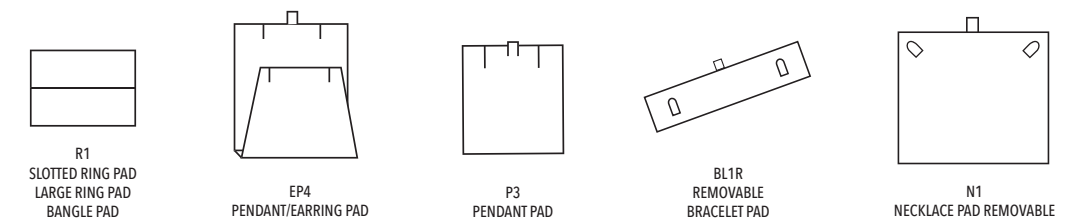

**FOIL / PAD PRINT**  
F: inside and top lid / PP: inside and top lid  
50/100+ 35c each  
1000+ 32c each  
2500+ 26c each

Minimum one case pack.  
Please allow 2 - 3 weeks for printed items from approved art.

All print orders subject to set-up charges. Applicable artwork, and plate charges may apply. See page 98.

All print orders subject to set-up charges. Applicable artwork, and plate charges may apply. See page 98.

# SPECIAL ORDER

## Nest Boxes

### Cotton Filled

CODE	PRICE /EACH	
	50+	1000+
31011	\$1.03	\$0.94
31021	\$1.10	\$1.00
31032	\$1.23	\$1.11
31033	\$1.46	\$1.32
31036	\$1.64	\$1.49
31034	\$1.78	\$1.62
31053	\$1.70	\$1.55
31065	\$2.38	\$2.17
31082	\$1.60	\$1.46
31085	\$3.04	\$2.76



Minimum one case pack.  
Estimated lead time - Please allow 3 weeks for unprinted items and 4 weeks for printed items from approved art.

**FOIL / PAD PRINT**  
F: top lid only / PP: top lid only  
50/100+ 35¢ each  
1000+ 32¢ each  
2500+ 26¢ each

#### Available Colours



CODE	SIZE (inches)	CASE PACK	Available Colours											
			061	000K	007	008	009	029	354	353	045	0155	015P	055
31011	1.75 x 1.125 x .625	100	✓	✓	✓	✓	-	-	-	-	-	✓	✓	-
31021	2.5 x 1.5 x .875	100	✓	✓	✓	✓	✓	✓	✓	✓	✓	✓	✓	✓
31032	3 x 2.125 X 1	100	✓	✓	✓	✓	✓	✓	✓	✓	✓	✓	✓	✓
31033	3.5 x 3.5 x 1	100	✓	✓	✓	✓	✓	✓	✓	✓	✓	✓	✓	✓
31036	3.5 x 3.5 x 1.5	100	-	✓	✓	✓	-	-	-	-	-	✓	✓	✓
31034	3.5 x 3.5 x 2	100	-	✓	✓	✓	-	-	-	-	-	✓	✓	✓
31053	5.25 x 3.75 x .875	100	✓	✓	✓	✓	✓	✓	✓	✓	✓	✓	✓	✓
31065	6 x 5 x 1	50	-	✓	✓	✓	✓	✓	✓	-	✓	✓	✓	✓
31082	8 x 2 x .875	100	-	✓	✓	✓	✓	✓	✓	-	✓	✓	✓	✓
31085	8 x 5.5 x 1.25	50	✓	✓	✓	✓	-	-	-	-	✓	✓	✓	✓



CODE	SIZE (inches)	CASE PACK	Available Colours											
			093	098	099	060	056	028	025	026	076	075	081	019
31011	1.75 x 1.125 x .625	100	-	-	-	-	-	-	-	-	-	✓	✓	-
31021	2.5 x 1.5 x .875	100	✓	✓	✓	✓	✓	✓	✓	✓	✓	✓	✓	✓
31032	3 x 2.125 X 1	100	✓	✓	✓	✓	✓	✓	✓	✓	✓	✓	✓	✓
31033	3.5 x 3.5 x 1	100	✓	✓	✓	✓	✓	✓	✓	✓	✓	✓	✓	✓
31036	3.5 x 3.5 x 1.5	100	-	-	-	-	✓	-	-	-	✓	✓	-	-
31034	3.5 x 3.5 x 2	100	-	-	-	-	✓	-	-	-	✓	✓	-	-
31053	5.25 x 3.75 x .875	100	✓	✓	✓	✓	✓	✓	✓	✓	✓	✓	✓	✓
31065	6 x 5 x 1	50	✓	✓	✓	-	✓	-	✓	✓	✓	✓	✓	-
31082	8 x 2 x .875	100	✓	-	-	-	✓	-	-	-	✓	✓	-	-
31085	8 x 5.5 x 1.25	50	-	-	-	-	-	-	-	-	✓	✓	-	-

## Berkeley Series

Four sizes, including one that can accommodate gift cards, are available, each with a white flocked removable platform.

See page 61 for more information and for matching paper bags!  
**All are recyclable, reusable and biodegradable.**



All print orders subject to set-up charges. Applicable artwork, and plate charges may apply. See page 98.

# IN STOCK

## Nest Boxes



These boxes match our **Damask Paper Shoppers** - page 63 and **Damask Pouches** - page 49



## Damask

Style and substance in a simple packaging combination.

- Black and white 2-piece box
- 100% recycled board box
- Cotton fill pad wrapped with damask patterned tissue
- See our matching bag and pouch to complete your collection

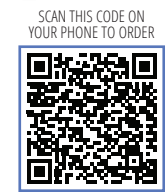

**FOIL / PAD PRINT**  
F: top lid only / PP: top lid only  
100+ 35¢ each  
1000+ 32¢ each  
2500+ 26¢ each

Estimated lead time: 2 - 3 weeks for printed items from approved art.

CODE	DESCRIPTION	SIZE (inches)	CASE PACK	PRICE /EACH	
				100+	1000+
31570153D	Earring	3 x 2.125 x 1	100	\$0.78	\$0.67
31555153D	Brooch	3.5 x 3.5 x 1	100	\$0.92	\$0.79
31564153D	Bracelet	8 x 2 x .875	100	\$1.08	\$0.94
31558153D	Necklace	6 x 5 x 1	100	\$1.57	\$1.33

Minimum order is one case pack.

White Swirl Pattern

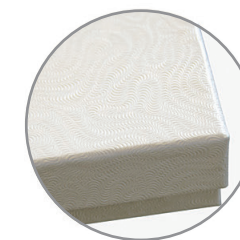

## White Economy

Sometimes a simple box is all you need!

- Made with 100% recycled board covered with white swirl paper
- Cotton filled to hold jewellery in place



**FOIL / PAD PRINT**  
F: top lid only / PP: top lid only  
50/100+ 35¢ each  
1000+ 32¢ each  
2500+ 26¢ each

Estimated lead time: 2 - 3 weeks for printed items from approved art.

CODE	DESCRIPTION	SIZE (inches)	CASE PACK	PRICE /EACH	
				50+	1000+
31502103	Charm	2.5 x 1.5 x .875	100	\$0.67	\$0.59
31570103	Earring	3 x 2.125 x 1	100	\$0.75	\$0.63
31555103	Brooch	3.5 x 3.5 x 1	100	\$0.85	\$0.75
31564103	Bracelet	8 x 2 x .875	100	\$0.96	\$0.85
31558103	Necklace	6 x 5 x 1	50	\$1.23	\$1.11
31576103	Large Necklace	8 x 5.5 x 1.25	50	\$1.90	\$1.65
31259103	Stand-Up Bangle	3.5 x 2 x 2 x 2	100	\$2.46	\$2.21

Minimum order is one case pack.

All print orders subject to set-up charges. Applicable artwork, and plate charges may apply. See page 98.

# SPECIAL ORDER

## Gift Card Boxes



### Monte Carlo Gift Card Box

People love gift cards, this box takes the presentation to a new level.

- Smooth paper hinged box with magnetic closure
- Removable insert holds card securely
- We suggest the black box with our gloss black GL2 print

CODE	SIZE (inches)	CASE	PRICE/EACH	
			100+	1000+
310239 __	5.125 x 4 x 1	100	\$3.82	



#### FOIL / PAD PRINT

F: inside lid only / PP: inside and outside lid

100+	35¢ each
1000+	32¢ each
2500+	26¢ each

Estimated lead time: 3 weeks for unprinted items and 4 weeks for printed items from approved art.

Gift Cards Not Included.

Gift Cards Not Included.

# IN STOCK

## Gift Card Boxes



### Black Box with Ribbon

Estimated lead time: 2 - 3 weeks for printed items from approved art.

Minimum order is one case pack.

CODE	SIZE (inches)	CASE	PRICE/EACH	
			100+	1000+
31040315	4 x 3 x .625	100	\$1.76	\$1.34



#### FOIL / PAD PRINT

F and PP: inside and top lid

100+	35¢ each
1000+	32¢ each
2500+	26¢ each



### Pewter Box with Ribbon

Estimated lead time: 2 - 3 weeks for printed items from approved art.

Minimum order is one case pack.

CODE	SIZE (inches)	CASE	PRICE/EACH	
			50+	1000+
31040742	7.5 x 4.25 x .625	50	\$2.42	\$2.28



#### FOIL / PAD PRINT

F and PP: inside and top lid

50+	35¢ each
1000+	32¢ each
2500+	26¢ each



### Gift Card Nest Box

- White paperboard platforms
- Silver or White exterior

CODE	SIZE (inches)	CASE	PRICE/EACH	
			100+	1000+
313230 __	3.5 x 2.25 x .75	100	\$2.13	



Estimated lead time: 3 weeks for unprinted items and 4 weeks for printed items from approved art.



### Gift Certificate Box

Minimum order is one case pack.

CODE	SIZE (inches)	CASE PACK	PRICE/EACH	
			100+	1000+
0922100 _ B	Gift Certificate Box Only see colour options 6.625 x 3.25 x .5	100	\$2.68	

Gift Certificate Box Colour:



#### FOIL / PAD PRINT

F and PP: top lid only

100+	35¢ each
1000+	32¢ each
2500+	26¢ each



Sold separately.

### Gift Certificate and Box

Estimated lead time: 2 - 3 weeks for printed items from approved art.

CODE	SIZE (inches)	CASE PACK	PRICE/EACH	
			100+	1000+
09221002B	White Gift Certificate Box Only	100	\$2.68	
18197	English Gift Certificate 6.375 x 3.125" folded	100	\$0.85	
18196	French Gift Certificate 6.375 x 3.125" folded	100	\$0.85	

Gift certificates are pre-numbered.



#### FOIL / PAD PRINT

F and PP: certificate and top lid

100+	35¢ each
1000+	32¢ each
2500+	26¢ each

Minimum order is one case pack.

## IN STOCK Finishing Touches

Available to finish the look of your gift certificate/card.

Stretch Loops (100 pack min.)

09500607 6" -	Gold	\$0.16/ea
09500608 6" -	Silver	\$0.16/ea
09501007 10" -	Gold	\$0.18/ea
09501008 10" -	Silver	\$0.18/ea

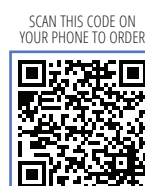

Dress it up with printed ribbon!  
See page 90.



# SPECIAL ORDER

## Pouches

### Natural Jute and Natural Cotton

• Minimum 100 per size.  
Estimated lead time: 6 weeks for printed items from approved art.



#### Natural Cotton - FOIL PRINT ONLY

CODE	SIZE (in.)	PRICE /EACH	
		100+	1000+
09030400NC	3 x 4	\$0.64	\$0.52
09050600NC	5 x 6	\$0.90	\$0.74
09061000NC	6 x 10	\$1.36	\$1.11
09081200NC	8 x 12	\$1.82	\$1.49

#### Natural Jute - NO PRINT

CODE	SIZE (in.)	PRICE /EACH	
		100+	1000+
09050500NJ	3 x 5 1/2	\$1.18	\$0.97
09050600NJ	5 x 6	\$1.40	\$1.14
09061000NJ	6 x 10	\$1.85	\$1.52

**FOIL PRINT**  
100+ 32c each  
1000+ 29c each  
2500+ 24c each

## Organza

CODE	SIZE (inches)	PRICE /EACH	
		100+	1000+
A 09905 ___	2 x 2.5	\$0.45	\$0.37
B 09910 ___	3 x 4	\$0.48	\$0.39
C 09915 ___	4 x 5.5	\$0.63	\$0.51
D 09920 ___	5 x 6.5	\$0.72	\$0.59
E 09925 ___	5.5 x 9	\$1.07	\$0.87
F 09930 ___	6 x 14	\$1.25	\$1.01
G 09950 ___	22 x 25 (not shown)	\$4.13	\$3.31

Organza Colours (Not exactly as shown.)

Black - 030	Silver - 012	White - 029
Hunter - 589	Navy - 370	Smoke Blue - 337
Lt. Blue - 305	Burgundy - 276	Ultra Violet - 467
Purple - 465	Lavender - 430	Copper - 073
Orange - 750	Olive - 563	Mint - 530
Red - 250	Pink - 115	Gold - 690
Baby Maize - 617	Ivory - 810	Mauve - 161
Pastel Green - 513	Fruit Punch - 155	Yellow - 645
Turquoise - 340	Royal - 350	Fuchsia - 187



Minimum 100 per size/colour.

Estimated lead time: 6 weeks for printed items from approved art.  
Foil printed to be determined.

**FOIL PRINT - TBD**  
100+ 35c each  
1000+ 32c each  
2500+ 26c each

A is only available in Silver, White, Pink, Lavender, Gold and Ivory.

F not available in Fruit Punch, Orange, Royal, Turquoise and Yellow.

G is only available in Silver, White, Pink, Red, Burgundy, Lt. Blue, Royal, Lavender, Mint, Olive, Gold and Ivory.

# IN STOCK

## Pouches

### Geo Series

• Minimum case pack 12.

Estimated lead time: 2 - 3 weeks for printed items from approved art.



CODE	TYPE	SIZE (in.)	PRICE /EACH	
			12+	144+
A 09030415B	Geo Pouch with Black Box	3 x 4	\$2.91	\$2.47
B 09030456P	Geo Pouch with Purple Box	3 x 4	\$2.91	\$2.47
C 09030427T	Geo Pouch with Bronze Box	3 x 4	\$2.91	\$2.47

**FOIL / PAD PRINT**  
F and PP: pouch and packer lid  
12+ 35c each  
144+ 32c each  
504+ 26c each

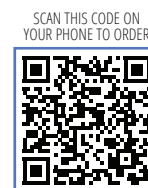

Estimated lead time: 2 - 3 weeks for printed items from approved art.

**FOIL / PAD PRINT**  
100+ 35c each  
1000+ 32c each  
2500+ 26c each

+ Bell Pouches and Wedding Pouch minimums:

**FOIL / PAD PRINT**  
12+ 35c each  
144+ 32c each  
504+ 26c each

# IN STOCK

## Pouches

### Microfiber

• Minimum case pack 100

Economical packaging for inexpensive items or repairs.



CODE	COLOUR	SIZE (inches)	PRICE /EACH	
			100+	500+
09040315	Black	4 x 3	\$1.33	\$1.17
09050415	Black	5-1/2 x 4	\$1.98	\$1.68
09040311	Blue	4 x 3	\$1.33	\$1.17
09050411	Blue	5-1/2 x 4	\$1.98	\$1.68

#### Damask Pouches

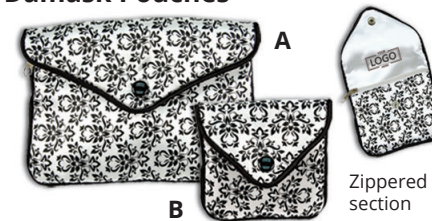

Zippered section

#### Envelope Pouches with snap closure



Available in black. Packaged in a 2-piece, pearlized, dark grey outer box.

#### Microfiber Bell Pouches +

• Minimum case pack of 12



#### White Leatherette Pouches



Gold Metallic Pouches

#### Velveteen Pouches



Black - 615
Royal Blue - 611
Brown - 612
Green - 667
Burgundy - 666

\*\*See chart for 2-piece SPECIAL ORDER outer box for the Velveteen pouches.

#### Wedding Pouches +

White satin pouch with a white 2-piece outer box. • Minimum case pack 12



CODE	TYPE	SIZE (in.)	CASE PACK	PRICE/EACH	
				100+	1000+
A 09040515D	Large Damask Pouch	5.5 x 4	100	\$3.01	\$2.47
B 09030315D	Small Damask Pouch	3 x 3	100	\$1.93	\$1.75
C 09304715	Large Envelope Pouch	3 x 4	100	\$2.94	\$2.78
D 09203715	Small Envelope Pouch	2.375 x 2.75	100	\$2.27	\$2.08
E 09525115B	Large Microfiber Bell Pouch	4.375 x 5.3751	12	\$1.53	\$1.31
F 09324115B	Small Microfiber Bell Pouch	3.25 x 4.5	12	\$1.23	\$1.06
G 09314700	Large White Leatherette Pouch	3 x 4	100	\$1.05	\$0.92
H 09203700	Small White Leatherette Pouch	2.75 x 3.25	100	\$0.75	\$0.67
I 09314807	Gold Metallic Pouch	3 x 4	100	\$0.81	\$0.79
J 09405 ___	*Velveteen Pouches	4 x 5.5	100	\$1.01	\$0.68
K 09314 ___	*Velveteen Pouches	3 x 4	100	\$0.83	\$0.57
31314003	White 2-piece outer box**	3.25 x 4.25	100	\$1.34	\$1.22
31065000K	White 2-piece outer box	6 x 5 x 1	50	\$2.38	\$2.17
L 37501006	White Wedding Pouches	1.875 x 2.5	12	\$1.08	\$0.87

\* See photo for colour code

All print orders subject to set-up charges. Applicable artwork, and plate charges may apply. See page 98.

All print orders subject to set-up charges. Applicable artwork, and plate charges may apply. See page 98.

# SPECIAL ORDER

## Jewellery Care

Customize with your store brand!

Quality professional jewellery care, such as LAVISH, starts as an add-on sale or complimentary gift with purchase and keeps customers coming back for more. Every time customers clean their jewellery with customized LAVISH jewellery care, they will think of your store.

SCAN THIS CODE ON YOUR PHONE TO ORDER



Estimated lead time: 3-4 weeks for printed items from approved art.

## Full Colour Digital Printed Labels

Create your own full colour look or our artist can create a design for your approval. Estimated lead time: 3 - 4 weeks for custom printed items from approved art.



### Lavish Jewellery Bath

8 fl. oz. (236 ml)  
**04530000C** \$5.93 ea  
 Minimum order 150 jars



### Lavish Polishing Cloth

6" x 4" - Slate Grey with Vellum Envelope  
**04540000C** \$5.21 ea

Screen print colours: Black, Silver, Gold or White  
 Minimum order 200 cloths



### Lavish Foam

1.69 fl. oz. (50 ml)      2.5 fl. oz. (75 ml)  
**04510050C** \$6.97 ea    **04510075C** \$9.13 ea  
 Minimum order 96 bottles per size



### Lavish Click Clean Pen

.108 fl. oz. (3.2 ml)  
**04520000C** \$7.40 ea  
 Minimum order 100 pens



Non-Toxic



Made in the USA



Biodegradable



Safe

User and Eco Friendly. Lavish is a bio-based cleaning formula that contains no harsh chemicals, peroxides, phosphates, or ammonia.

Lavish was developed and is made by a 3rd generation jeweller/gemologist whose ambition is to provide you with the safest, and most effective product available.

Lavish is biodegradable. It breaks down rapidly and completely, meaning it will not contaminate or pollute our water, or our environment.

Lavish is safe for you, your jewelry, and our planet. From costume jewelry to your heirloom pieces, Lavish will bring back the sparkle and shine without the worry.

## Diamond & Gem Cloths

Microfiber Cloth removes small dust, oily film, fingerprints and other residue from fine jewellery. Chemical Free. Lint Free. AVAILABLE IN LIGHT BLUE ONLY. Estimated lead time: 4 - 6 weeks for custom printed cloths from approved art.

8 x 8" Blue Cloth **04780800C** \$5.12 ea  
 Minimum order is 144 cloths.



# IN STOCK

## Jewellery Care

Available for immediate shipment.

We care about your jewellery as much as you do!



We care about your jewellery, that's why we use better ingredients, better packaging, and you get better performance to keep you sparkling brighter all day long. Use Lavish everyday to safely and conveniently make your jewellery sparkle and shine more than it ever has.



SCAN THIS CODE ON YOUR PHONE TO ORDER



### Lavish Jewellery Bath

Jewellery bath includes 1 pod of our jewellery cleaner concentrate. An effective jewellery cleaner that can be used on all jewellery from Pearls and Opals to Diamonds without the risk of damage.

8 fl. oz. (236 ml)  
**04530000** \$6.23 ea  
 50 per case pack



### Lavish Foam

Our Lavish Jewellery Cleaning Foam is our #1 customer favorite product. The foam is a special blend of bio-based surfactants that coalesce in a foam to efficiently break down the daily buildup of grime and allow it to be easy rinsed away leaving nothing but sparkle and shine. The foam is dispensed through a non-aerosol pump foamer, so there are no nasty propellants to damage our ozone layer.

1.69 fl. oz. (50 ml)      2.5 fl. oz. (75 ml)  
**04510050** \$7.31 ea    **04510075** \$9.58 ea  
 48 per case pack per size



### Lavish Click Clean Pen

The Lavish Click Clean Pen is the ultra portable, ultra quick way to put the bling back in your ring. The non-toxic formulation is safe for all your jewellery and is ready to go whenever, wherever you are. The one-handed click action gives you control so you can dispense just the right amount of cleaning solution onto your jewellery. The soft brush tip makes it easy to get into hard to reach areas of your jewellery and underneath stones.

.108 fl. oz. (3.2 ml)  
**04520000** \$7.77 ea    50 per case pack



### Lavish Polishing Cloth

Gold, Silver, Platinum oh my!

Bring back the shine of all your metals with the Lavish signature polishing cloth. Our polishing cloth is infused with a gentle and effective polishing compound that will bring back the luster and shine to your jewellery. Great for use on gold, silver, platinum, and other precious metals.

Note: To avoid the possibility of small scratches, care should be taken to avoid contact with stones other than diamonds. 8 fl. oz. (236 ml)

6" x 4" - Slate Grey with Vellum Envelope  
**04540000** \$5.47 ea  
 50 per case pack



## Handling Gloves

White microfiber. One size fits all  
 The natural oils in our skin can often leave displeasing marks on jewellery. Our microfiber, lint-free gloves are ideal for handling and protecting your most precious inventory.

**05000296** \$2.95 /pair  
 Minimum order - 6 pairs

# IN STOCK

## Jewellery Care

Estimated lead time: 2 - 3 weeks for printed items from approved art.



### Repair Envelopes

CODE	DESCRIPTION	SIZE (in)	1000	3000	5000	10000
A 09850000	2-Part NCR	4.25 x 9	\$0.41	\$0.37	\$0.32	\$0.26
B 09845200	Plain-no perf., text or numbers	3.5 x 6.125	\$0.18	\$0.16	\$0.15	\$0.14
C 09845300	Double Perforated	3.5 x 6.125	\$0.22	\$0.19	\$0.16	\$0.14
D 09845400	Single Perforated	3.5 x 6.125	\$0.24	\$0.21	\$0.18	\$0.15
E 09850000E	2-part NCR - NO PRINT	4.25 x 9	\$0.30	\$0.30	\$0.30	\$0.30

SCAN THIS CODE ON YOUR PHONE TO ORDER



• Prices include one colour printing. A second colour is \$ 0.029/each.  
Minimum 1000 per style. Printing colours: Black, Red, Green and Blue



Please allow 2 - 3 weeks for printing.  
\$37 set-up charge applies.

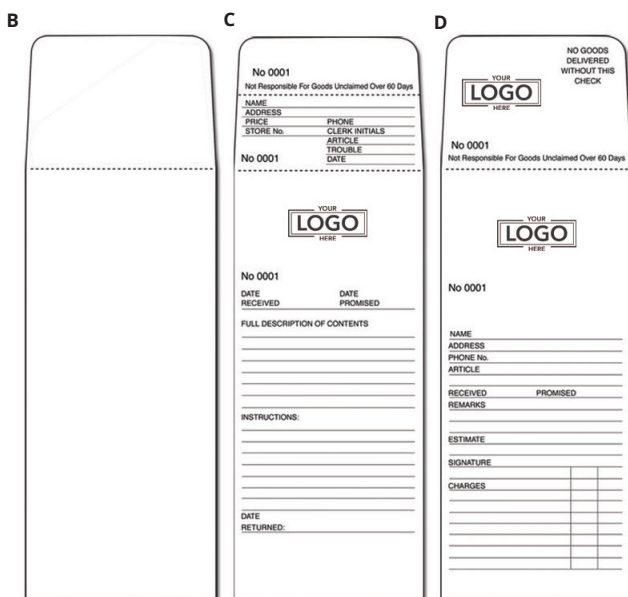

### Tags and Miscellaneous Accessories



CODE	DESCRIPTION	PACK MIN.	PRICE
E 08270207	Plastic Ring Tags - Gold	Box/1000	\$136.21
F 08270208	Plastic Ring Tags - Silver	Box/1000	\$136.21
G 08090707	Plastic With String Tags - Gold	Box/1000	\$136.21
H 08090708	Plastic With String Tags - Silver	Box/1000	\$136.21
I 08810800	Super Mylar Ring Tags - Wide	Box/1000	\$53.66
J 08810700	Super Mylar Ring tags - Narrow	Box/1000	\$35.77
08833000	Fine Pen Marker (not shown)	1	\$15.13

SCAN THIS CODE ON YOUR PHONE TO ORDER



# BAGS

## EUROTOTES, SHOPPERS, CYOL, REUSABLE & APPAREL



Available for immediate shipping for above items.

All print orders subject to set-up charges. Applicable artwork, and plate charges may apply. See page 98.

# IN STOCK

## Rope Handle Eurototes

SCAN THIS CODE ON YOUR PHONE TO ORDER



BAGS



08V - Silver

Linen Paper Detail

Vantage II Eurototes  
Available Colours



08V - Silver  
Matches Vantage Silver  
Hinged Packaging  
See page 29.

07V - Gold  
Matches Vantage Gold  
Hinged Packaging  
See page 29.

## Vantage II Eurototes

- 150 gsm uncoated art paper
- 5 mm pp cord knotted handles
- Folded top turn and cardboard reinforced bottom
- Minimum order is 100 per colour per size

CODE	SIZE (inches)	PRICE/EACH		
		100+	500+	1000+
A 230606 ___	6 x 3.5 x 6 x 3.5	\$1.28	\$1.17	\$1.01
B 231008 ___	10.5 x 5 x 8.5 x 5	\$1.63	\$1.46	\$1.25

Estimated lead time: 2 - 3 weeks for printed items from approved art.



**FOIL PRINT**  
100+ 35¢ each  
1000+ 32¢ each  
2500+ 26¢ each

Eclipse and Geo Eurototes  
Available Colours



56G - Purple  
Matches Geo Purple  
Hinged Packaging  
See page 23.

27G - Bronze  
Matches Geo Bronze  
Hinged Packaging  
See page 23.



27G - Bronze

Shimmer Paper Detail

## Eclipse and Geo Eurototes

- 150 gsm uncoated art paper
- 5 mm pp cord knotted handles
- Folded top turn and cardboard reinforced bottom
- Minimum order is 100 per colour per size



66E - Aubergine  
Matches Eclipse Aubergine  
Hinged Packaging  
See page 19.

81E - Blue  
Matches Eclipse Blue  
Hinged Packaging  
See page 19.

All print orders subject to set-up charges. Applicable artwork, and plate charges may apply. See page 98.

# IN STOCK

## Luxury Grosgrain Handle Eurototes

BAGS



## Luxury Grosgrain Handle Eurototes

- Gloss and matte lamination
- 157 gsm art paper
- 7/8" matching grosgrain, knotted handles
- Fold over top turn and cardboard reinforced bottom
- Minimum order is 100 per colour per size

CODE	SIZE (inches)	CASE PACK	PRICE/EACH		
			100+	500+	1000+
A 230606 ___	6 x 3 x 6 x 3	100	\$1.18	\$1.06	\$0.91
B 230810 ___	8 x 4 x 10 x 4	100	\$1.24	\$1.12	\$0.96
C 231209 ___	12.5 x 4.5 x 9 x 4.5	100	\$1.49	\$1.34	\$1.15
D 231612 ___	16 x 6 x 12 x 6	100	\$2.03	\$1.83	\$1.56
E 232014 ___*	20 x 6 x 14 x 6	100	\$2.27	\$2.04	\$1.76

\* champagne and pewter not available in this size.

Estimated lead time: 2 - 3 weeks for printed items from approved art.



**FOIL PRINT**  
100+ 35¢ each  
1000+ 32¢ each  
2500+ 26¢ each



**TRANSFER PRINT**  
100+ \$2.45 each  
1000+ \$2.25 each  
300 bags minimum

Available Colours



15BM  
Black Matte

15BG  
Black Gloss

02C  
Champagne

08P  
Pewter

00W  
White

SCAN THIS CODE ON YOUR PHONE TO ORDER



All print orders subject to set-up charges. Applicable artwork, and plate charges may apply. See page 98.

# IN STOCK

## Eco-Lux Eurototes

**New**



### Eco-Lux Eurototes

- 100% recyclable
- 138 gsm art paper
- 8 mm paper rope handle
- Folded top turn and cardboard reinforced bottom
- Minimum order is 100 per colour per size

CODE	TYPE	SIZE (inches)	CASE PACK	PRICE/EACH		
				100+	500+	1000+
A 239606 __	Novelty	6 x 3.5 x 6 x 3.5	100	\$1.17	\$1.04	\$0.91
B 239709 __	Small gift	9 x 3.5 x 7 x 3.5	100	\$1.33	\$1.14	\$1.02
C 239810 __	Gift	8 x 4 x 10 x 4	100	\$1.46	\$1.25	\$1.14
D 230908 __ T	Trapezoid	9/7 x 4 x 8.5 x 4	100	\$1.72	\$1.40	\$1.34
E 238116 __	Fashion	16 x 6 x 12 x 6	100	\$2.70	\$2.37	\$2.06
F 231011 __	Watch	10 x 5 x 11 x 5	100	\$1.88	\$1.55	\$1.38



Estimated lead time: 2 - 3 weeks for printed items from approved art.



**FOIL PRINT**  
100+ 35¢ each  
1000+ 32¢ each  
2500+ 26¢ each



**DIGITAL PRINT\***  
1-999 62¢ each  
1000-2999 40¢ each  
3000+ 35¢ each



**TRANSFER PRINT**  
100+ \$2.45 each  
1000+ \$2.25 each  
300 bags minimum

\*Best printed on white.



15-Black 00-White 07-Gold 08-Silver 42-Brown 11-Blue 10-Green

	15-Black	00-White	07-Gold	08-Silver	42-Brown	11-Blue	10-Green
Novelty	✓	✓	✓	✓	✓	✓	✓
Small Gift	✓	✓	✓	✓	✓	✓	✓
Gift	✓	✓	✓	✓	✓	✓	✓
Trapezoid	✓	✓	✓	—	✓	—	—
Fashion	✓	✓	✓	✓	✓	—	—
Watch	✓	✓	✓	—	—	—	—

All print orders subject to set-up charges. Applicable artwork, and plate charges may apply. See page 98.

# IN STOCK

## All Paper Eurototes



### All Paper Eurotote with Paper Rope Handle

- 100% recyclable
- 40% post-consumer waste
- 190 gsm uncoated paper
- 8 mm paper cord knotted handles
- Folded top turn and cardboard reinforced bottom
- Minimum order is 100 per colour per size

CODE	SIZE (inches)	CASE PACK	PRICE/EACH		
			100+	500+	1000+
A 230606 _ _ _ _	6 x 3.5 x 6 x 3.5	100	\$0.99	\$0.88	\$0.75
B 230810 _ _ _ _	8 x 4 x 10 x 4	100	\$1.08	\$0.95	\$0.81
C 231013 _ _ _ _	10 x 5 x 13 x 5	100	\$1.23	\$1.08	\$0.91
D 231612 _ _ _ _	16 x 6 x 12 x 6	100	\$1.85	\$1.64	\$1.40

Estimated lead time: 2 - 3 weeks for printed items from approved art.  
\*Black and Navy bags cannot be digital printed.



**FOIL PRINT**  
100+ 35¢ each  
1000+ 32¢ each  
2500+ 26¢ each



**DIGITAL PRINT**  
1-999 62¢ each  
1000-2999 40¢ each  
3000+ 35¢ each

\*Best printed on kraft, white and cream bags.

Available Colours



75AK Kraft 00AW White 15AB Black 28AC Cream



All print orders subject to set-up charges. Applicable artwork, and plate charges may apply. See page 98.

# CREATE YOUR OWN LOOK

## Full Colour Paper Eurototes

Make a creative impression...  
the combinations are endless!



Prices include up to 2 ink print colours:

TYPE	SIZE (inches)
Novelty	6 x 3.5 x 6 x 3.5
Small Gift	9 x 3.5 x 7 x 3.5
Gift	8 x 4 x 10 x 4
Trapezoid	9/7 x 4 x 8.5 x 4
Wine	3.375 x 3.5 x 13 x 3.5
Fashion	16 x 6 x 12 x 6
Saville	16 x 6 x 19 x 6

Prices include 4 colour process print:

TYPE	SIZE (inches)
Novelty	6 x 3.5 x 6 x 3.5
Small Gift	9 x 3.5 x 7 x 3.5
Gift	8 x 4 x 10 x 4
Trapezoid	9/7 x 4 x 8.5 x 4
Wine	3.375 x 3.5 x 13 x 3.5
Fashion	16 x 6 x 12 x 6
Saville	16 x 6 x 19 x 6

• Combination foil print and ink printing available.

• No charge for printing plates  
(proof charge applies)

• Substitute a satin ribbon handle for the  
standard rope

Unique printing  
options available.

Double Stamping  
shown here.



Estimated lead time: 14 - 16  
weeks for delivery from  
approved art.



### Create Your Own Look:

Choose your bag style.  
Send us your artwork.  
For 100% full colour  
design, speak to your  
sales representative.

• Add metal grommets to your bag

# SPECIAL ORDER



## Manhattan Eurototes

- Made with 40% PCW\*
- Made with 75% PCW\*\*
- Biodegradable
- 5/8" poly/cotton twill knotted handle
- Recyclable once handle has been removed
- Folded top turn and cardboard reinforced bottom

SCAN THIS CODE ON  
YOUR PHONE TO ORDER



12" Wide Gussets!



CODE	TYPE	CASE	PRICE/EACH		
			100+	500+	1000+
A 245845 __	Mini	100	\$1.31	\$1.24	\$1.18
B 245841 __	Petite	100	\$1.64	\$1.55	\$1.48
C 245843 __	Vanity	100	\$2.08	\$1.97	\$1.87
D 245844 __	Fashion	100	\$2.85	\$2.70	\$2.56
E 245860 __	X-Large	50	\$4.39	\$4.16	\$3.95
F 245898 __	Bottle Bag	100	\$1.80	\$1.70	\$1.62

CODE	TYPE	CASE	PRICE/EACH		
			100+	500+	1000+
24585615	Medium - Black	100	\$5.85	\$5.55	\$5.27
24585715	Large - Black	100	\$6.55	\$6.20	\$5.89
24585600	Medium - White	100	\$5.85	\$5.55	\$5.27
24585700	Large - White	100	\$6.55	\$6.20	\$5.89
24585675	Medium - Kraft	100	\$5.85	\$5.55	\$5.27
24585775	Large - Kraft	100	\$6.55	\$6.20	\$5.89

Available  
Colours



Estimated lead time: 3 - 5  
weeks for printed items  
from approved art.



**FOIL PRINT**  
100+ 35¢ each  
1000+ 32¢ each  
2500+ 26¢ each



**TRANSFER PRINT**  
100+ \$2.45 each  
1000+ \$2.25 each  
300 bags minimum

Style	15* Black	00* White	75** Kraft	08* Grey	09* Red	41* Fuchsia	11** Navy	61* Green
Mini 5 x 4 x 6 x 4 in	✓	✓	✓	✓	✓	✓	✓	✓
Petite 8 x 4 x 10 x 4 in	✓	✓	✓	✓	✓	✓	✓	✓
Vanity 10 x 5 x 13 x 5 in	✓	✓	✓	✓	✓	✓	✓	✓
Fashion 16 x 6 x 12 x 6 in	✓	✓	✓	✓	✓	✓	✓	✓
X-Large 20 x 6 x 14 x 6 in	✓	✓	✓	—	—	—	—	—
Bottle 4.5 x 4.5 x 15 x 4.5 in	✓	✓	✓	—	✓	—	—	—
Wide Gusset Medium 12.5 x 12 x 12 x 12 in.	✓	✓	✓	—	—	—	—	—
Wide Gusset Large 16 x 12 x 11 x 12 in.	✓	✓	✓	—	—	—	—	—

All print orders subject to set-up charges. Applicable artwork, and plate charges may apply. See page 98.

All print orders subject to set-up charges. Applicable artwork, and plate charges may apply. See page 98.

# SPECIAL ORDER

# SPECIAL ORDER

## Paper Shoppers

BAGS

BAGS



Thick Woven Handle Detail

Available Colours



## 5th Avenue Eurototes

- Embossed laminated finish with printed gloss and coordinating colour interior, 210 gsm
- Woven handles, top slit style, W fold bottom with removable bottom board
- Minimum order is 100 per colour per size

CODE	SIZE (inches)	CASE PACK	PRICE/EACH	
			100+	1000+
A 245820 __	8 x 3.5 x 6 x 3.5	100	\$3.37	\$3.19
B 245821 __	12.5 x 4.5 x 9 x 4.5	100	\$5.34	\$5.06
C 245822 ___	17 x 6 x 12.75 x 6	100	\$7.29	\$6.90

SCAN THIS CODE ON YOUR PHONE TO ORDER



**FOIL PRINT**  
100+ 35¢ each  
1000+ 32¢ each  
2500+ 26¢ each



**TRANSFER PRINT**  
100+ \$2.45 each  
1000+ \$2.25 each  
300 bags minimum



## Tints and Pinstripe on Kraft

- Twist paper handle
- 120 gsm paper

SCAN THIS CODE ON YOUR PHONE TO ORDER



Pinstripe Detail

Tints on Kraft



Pinstripe on Kraft



CODE	DESCRIPTION	SIZE (inches)	CASE PACK	PRICE/EACH
230508 ____	Prime	5 x 3 x 8 x 3	250	\$0.97
230809 ____	Petite	8 x 4.5 x 10	250	\$1.00
231611 ____	Fashion	16 x 6 x 12 x 6	250	\$1.57



**TRANSFER PRINT**  
250+ \$2.45 each  
1000+ \$2.25 each  
300 bags minimum



**INK PRINT**  
250+ 34¢ each  
1000+ 29¢ each  
2500+ 24¢ each

Estimated lead time:  
Approx. 6 weeks for No Print Bags.  
Approx 8 - 10 weeks for Printed items from approved art.



Available Colours



## San Fran Natural Shoppers

Simple yet striking keyline design collection.



100% Recyclable

CODE	SIZE (inches)	CASE PACK	PRICE/EACH		
			100+	500+	1000+
249703 __	7 x 3 x 7 x 3	100	\$1.19	\$1.14	\$1.10
249704 __	10 x 4 x 10 x 4	100	\$1.54	\$1.49	\$1.44
249711 __	16 x 6 x 12 x 6	100	\$2.25	\$2.17	\$2.09

SCAN THIS CODE ON YOUR PHONE TO ORDER



Please allow 2 - 3 weeks for printed items from approved art.



**FOIL PRINT**  
100+ 35¢ each  
1000+ 32¢ each  
2500+ 26¢ each



**DIGITAL PRINT**  
Only on white and kraft.  
1-999 62¢ each  
1000-2999 40¢ each  
3000+ 35¢ each



**TRANSFER PRINT**  
100+ \$2.45 each  
1000+ \$2.25 each  
300 bags minimum



**INK PRINT**  
100+ 34¢ each  
1000+ 29¢ each  
2500+ 24¢ each

\*Best printed on white and kraft bags.

## Berkeley Nest Boxes

Coordinating with San Fran Natural Shoppers, these 2-piece boxes finish the look.

- Glossy paper
- White flocked platform inserts

CODE	SIZE (inches)	CASE PACK	PRICE/EACH	
			100+	1000+
32201 ___	3 x 3 x 1.25	100	\$1.84	\$1.75
32202 ___	3.5 x 3.5 x 2	100	\$2.79	\$2.64
32203 ___	5 x 5 x 1.5	100	\$3.49	\$3.31
32204 ___	9 x 4.5 x 2*	100	\$4.38	\$4.15

\* 231 - Black, 849 - Red and 505 - Kraft are not available in this size.



**FOIL / PAD PRINT**  
F: top lid only / PP: top lid only  
100+ 35¢ each  
1000+ 32¢ each  
2500+ 26¢ each

Minimum one case pack.  
Estimated lead time - Please allow 3 weeks for unprinted items and 4 weeks for printed items from approved art.

Available Colours



100% Recycled Board

SCAN THIS CODE ON YOUR PHONE TO ORDER



# CREATE YOUR OWN LOOK

## Full Colour Simply Paper Shoppers

Make a creative impression...  
the combinations are endless!



### Simply Paper Shoppers

**Kraft with paper twist handles, print 1 colour on 2 sides <25%**

TYPE	SIZE (inches)	CASE PACK
Prime	5.25 x 3.5 x 8.25	250
Petite	8 x 4 x 10	250
Vanity	10 x 5 x 13	250
Celebrity	13 x 6 x 15.5	250
Fashion	16 x 6 x 12	250
Saville	16 x 6 x 19	200
Universal	18 x 6 x 19	200
Wine	5.25 x 3.5 x 13	250

Any 2 Sizes  
Minimum 3000  
Special Pricing

**White with paper twist handles, print 1 colour on 2 sides <25%**

TYPE	SIZE (inches)	CASE PACK
Prime	5.25 x 3.5 x 8.25	250
Petite	8 x 4 x 10	250
Vanity	10 x 5 x 13	250
Celebrity	13 x 6 x 15.5	250
Fashion	16 x 6 x 12	250
Saville	16 x 6 x 19	200
Universal	18 x 6 x 19	200
Wine	5.25 x 3.5 x 13	250

Any 2 Sizes  
Minimum 3000  
Special Pricing



**Create Your Own Look:**  
Choose your bag style.  
Send us your artwork.  
For 100% full colour  
design, speak to your  
sales representative.



96% Recycled Material

• Minimum 5,000 per size or any  
2 sizes, minimum 3000 per size

• Add a second colour

• Go 100% ink coverage

• Add a rope handle

Estimated lead time: 12 - 14  
weeks for printed items from  
approved art.



CODE	TYPE	SIZE (inches)	CASE	12 - Kraft PRICE/EACH		00 - White PRICE/EACH		Tints PRICE/EACH		Metallics PRICE/EACH	
				250+	1000+	250+	1000+	250+	1000+	250+	1000+
230508_*	Prime	5 x 3.5 x 8 x 3.5	250	\$0.44	\$0.37	\$0.55	\$0.43	\$0.68	\$0.57	\$0.61	\$0.52
230809_	Petite	8 x 4.5 x 10.75 x 4.5	250	\$0.50	\$0.44	\$0.55	\$0.47	\$0.71	\$0.64	\$0.76	\$0.68
230914_	Vanity	10 x 5 x 13 x 5	250	\$0.55	\$0.52	\$0.60	\$0.55	—	—	—	—
231315_	Celebrity	13 x 6 x 15 x 6	250	\$0.62	\$0.57	\$0.71	\$0.66	—	—	—	—
231611_	Fashion	16 x 6 x 12 x 6	250	\$0.61	\$0.57	\$0.66	\$0.60	\$0.87	\$0.77	\$1.20	\$1.09
231619_	Saville	16 x 6 x 19 x 6	**	\$0.79	\$0.67	\$0.90	\$0.79	\$1.18	\$1.08	\$1.86	\$1.73
231819_	Universal	18 x 7 x 18.75 x 7	200	\$0.81	\$0.71	\$0.88	\$0.79	—	—	—	—
230513_	Wine Shopper	5.25 x 3.5 x 13	250	\$0.82	\$0.76	\$0.98	\$0.91	—	—	—	—

Available Colours

	12- Kraft	00- White	35- Black	41- Navy	07- Gold	08- Silver
Prime	✓	✓	✓	✓	✓	✓
Petite	✓	✓	✓	✓	✓	✓
Vanity	✓	✓	—	—	—	—
Celebrity	✓	✓	—	—	—	—
Fashion	✓	✓	✓	✓	✓	✓
Saville	✓	✓	✓	✓	✓	✓
Universal	✓	✓	✓	✓	✓	✓
Wine	✓	✓	—	—	—	—

\* White and Kraft is 230508\_ P

\*\* Black, Navy, Gold and Silver 230508\_ PR

\*\* White and Kraft are sold in case packs of  
200 and the Black, Navy, Gold and Silver are  
sold in case packs of 250

**Sturdy, durable.  
Our best value bags.**

**FOIL PRINT**  
100+ 35¢ each  
1000+ 32¢ each  
2500+ 26¢ each

**DIGITAL PRINT**  
Only on white and kraft.  
1-999 62¢ each  
1000-2999 40¢ each  
3000+ 35¢ each

**TRANSFER PRINT**  
100+ \$2.45 each  
1000+ \$2.25 each  
300 bags minimum

**INK PRINT**  
100+ 34¢ each  
1000+ 29¢ each  
2500+ 24¢ each

Please allow 2 - 3 weeks for printed items from approved art.  
\*Best printed on kraft, white, gold and silver bags.



### Damask Paper Shoppers

• 110 gsm paper  
• Minimum order is 100 per size

CODE	TYPE	SIZE (inches)	CASE PACK	PRICE/EACH	
				100+	1000+
23080915D	Petite	8 x 4 x 10 x 4	100	\$0.71	\$0.62
23101315D	Vanity	10 x 5 x 13 x 5	100	\$0.76	\$0.66
23161215D	Fashion	16 x 6 x 12 x 6	100	\$0.89	\$0.76

Please allow 2 - 3 weeks for printed items from approved art.

**FOIL PRINT**  
100+ 35¢ each  
1000+ 32¢ each  
2500+ 26¢ each

**DIGITAL PRINT**  
1-999 62¢ each  
1000-2999 40¢ each  
3000+ 35¢ each

**TRANSFER PRINT**  
100+ \$2.45 each  
1000+ \$2.25 each  
300 bags minimum

**INK PRINT**  
100+ 34¢ each  
1000+ 29¢ each  
2500+ 24¢ each

All print orders subject to set-up charges. Applicable artwork, and plate charges may apply. See page 98.

# IN STOCK

## Paper Shoppers

The Mission Green Sustainable Solution for single-use plastic merchandise shoppers.



70% Recycled Material



Please allow 2 - 3 weeks for printed items from approved art.



**FOIL PRINT**  
100+ 35¢ each  
1000+ 32¢ each  
2500+ 26¢ each



**DIGITAL PRINT**  
1-999 62¢ each  
1000-2999 40¢ each  
3000+ 35¢ each



**TRANSFER PRINT**  
100+ \$2.45 each  
1000+ \$2.25 each  
300 bags minimum



**INK PRINT**  
100+ 34¢ each  
1000+ 29¢ each  
2500+ 24¢ each

## Merchandise Die Cut Bags

- Reinforced fold-over handle plus side gusset
- 80 gsm paper

CODE	SIZE (inches)	CASE PACK	PRICE/EACH
23081275	8 x 2 x 12	500	\$0.40
23101575	10 x 2 x 15	500	\$0.44
23141875	14 x 4 x 18	250	\$0.63



## Merchandise Bags

- 110 gsm paper

CODE	SIZE (in)	CASE	75 - Kraft PRICE/EACH	00 - White PRICE/EACH
230609__	6 x 9	2000	\$0.07	\$0.09
230710__	7 x 10	500	\$0.09	\$0.09
230912__	9 x 12	500	\$0.10	\$0.14
231114__	11 x 14	500	\$0.13	\$0.18
231316__	13 x 16	500	\$0.19	\$0.25

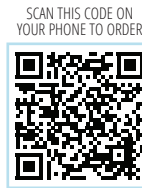

Please allow 2 - 3 weeks for printed items from approved art.



**FOIL PRINT**  
100+ 35¢ each  
1000+ 32¢ each  
2500+ 26¢ each



**DIGITAL PRINT**  
1-999 62¢ each  
1000-2999 40¢ each  
3000+ 35¢ each



**TRANSFER PRINT**  
100+ \$2.45 each  
1000+ \$2.25 each  
300 bags minimum



**INK PRINT**  
100+ 34¢ each  
1000+ 29¢ each  
2500+ 24¢ each

All print orders subject to set-up charges. Applicable artwork, and plate charges may apply. See page 98.

# IN STOCK

## Food Service Paper



Tamper Proof Strips  
Across Both Sets of Handles



100% Recycled Material

## Food Service Kraft Paper Shoppers

- Sturdy and durable
- 110 gsm
- Made from 100% recycled kraft paper

CODE	DESCRIPTION	SIZE (inches)	CASE PACK	PRICE/EACH	
				250+	1000+
A 23121775F	SOS Shopper	12 x 7 x 17 x 7	250	\$0.27	\$0.25
B 23141512F	Paper Twist with Tamper Tape	14 x 10 x 15.5 x 10	200	\$0.86	\$0.75

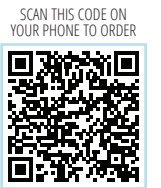

Please allow 2 - 3 weeks for printed items from approved art.



**FOIL PRINT**  
100+ 35¢ each  
1000+ 32¢ each  
2500+ 26¢ each



**DIGITAL PRINT**  
1-999 62¢ each  
1000-2999 40¢ each  
3000+ 35¢ each



**TRANSFER PRINT**  
100+ \$2.45 each  
1000+ \$2.25 each  
300 bags minimum



**INK PRINT**  
100+ 34¢ each  
1000+ 29¢ each  
2500+ 24¢ each

All print orders subject to set-up charges. Applicable artwork, and plate charges may apply. See page 98.

# CREATE YOUR OWN LOOK

BAGS

## Natural Jute/Cotton Bags

- 22" long and 1" width natural flat jute cotton handle

SIZE (inches)	PRICE/EACH			
	500+	1000+	2000+	5000+
16 x 14 x 3	\$4.67	\$4.03	\$3.36	\$3.00



3" Bottom Gusset

## Laminated Jute Bags

- 18" long and 1.5" width white cotton flat twill handle

SIZE (inches)	PRICE/EACH			
	500+	1000+	2000+	5000+
8 x 8	\$3.48	\$2.94	\$2.40	\$2.05

White Cotton Handle



## Markin Cotton Canvas Bags

- 24" long and 1" width Markin canvas flat handle

SIZE (inches)	PRICE/EACH			
	500+	1000+	2000+	5000+
12 x 16	\$4.25	\$3.72	\$3.16	\$2.88



All Canvas

## Mix Medium Jute Bags

- 12" long and 1" width Buffalo leather flat handle
- Top trim Joco fabrics in upper and lower portion of body
- Canvas cloth piping in the border of stitching
- Laminated

SIZE (inches)	PRICE/EACH			
	500+	1000+	2000+	5000+
16 x 18 x 6	\$13.91	\$11.71	\$10.71	\$9.78



## Tube Handle Natural Jute Laminated Bags

- 15" Round Tube Handle

SIZE (inches)	PRICE/EACH			
	500+	1000+	2000+	5000+
8 x 8	\$6.31	\$5.33	\$4.63	\$4.20



## Flat Handle Natural Jute Laminated Bags

- 16" long & 1.5" width jute flat handle

SIZE (inches)	PRICE/EACH			
	500+	1000+	2000+	5000+
12 x 16	\$6.05	\$4.98	\$4.54	\$4.14



# CREATE YOUR OWN LOOK

BAGS

# IN STOCK

## Ultrasonic

BAGS

**New**



### Ultrasonic Bag

- 110 GSM
- PP non woven
- Heat sealed construction - no stitching
- Durable

CODE	SIZE (inches)	CASE PACK	PRICE/EACH	
			100+	1000+
21091101	9 x 5 x 11	100	\$0.62	\$0.50
21161401	16 x 6 x 14	100	\$0.99	\$0.79

SCAN THIS CODE ON YOUR PHONE TO ORDER



**DIGITAL PRINT**  
 1-999 62¢ each  
 1000-2999 40¢ each  
 3000+ 35¢ each

Please allow 2 - 3 weeks for printed items from approved art.

# IN STOCK

## Reusable RPET

BAGS

**New**



RPET is known as Recycled Polyethylene Terephthalate. It's a strong, durable material constructed from 80% recycled plastic bottles.



00 - White

15 - Black

### Smart Bag

- 80 GSM
- RPET material
- Made from reclaimed water bottles
- Small bag made with 7 recycled plastic bottles
- Large bag made with 11 recycled plastic bottles

CODE	SIZE (inches)	CASE PACK	PRICE/EACH	
			100+	1000+
210912 __	9 x 5 x 12 x 5	100	\$1.68	\$1.46
211614 __	16 x 6 x 14 x 6	100	\$1.93	\$1.64



80% Recycled PET

SCAN THIS CODE ON YOUR PHONE TO ORDER



**FOIL PRINT - TBD**  
 100+ 35¢ each  
 1000+ 32¢ each  
 2500+ 26¢ each



**SCREEN PRINT**  
 100+ \$1.25 each  
 500+ \$1.08 each  
 1000+ 90¢ each

Please allow 2 - 3 weeks for printed items from approved art.

# CREATE YOUR OWN LOOK

## Reusable Fabric Style Shoppers

Make a creative impression...  
the combinations are endless!

# IN STOCK Reusable Shoppers



### Full Colour Laminated Bags

- Plates extra per design/side.  
Additions for extra charge
- Add matte lamination /bag
  - Add a carded bottom /bag
  - Zipper top /bag
  - Gusset print /bag



#### Shopping Bags (inches)

- 9 x 4 x 11 x 4
- 11 1/4 x 4 1/4 x 12 x 4 1/4
- 14 x 4 x 16 x 4
- 16 x 6 x 12 x 6
- 16 x 5 x 15 x 5

80 GSM NON-WOVEN  
SILK SCREEN PRINT ONE COLOUR 2 SIDES  
1"X24" HANDLES - "X" STITCH

---

100 GSM NON-WOVEN WITH LAMINATION  
PRINT 4 COLOUR PROCESS  
1"X24" PP WEBBING HANDLES - "X" STITCH



#### Non-woven Polypropylene

Soft, yet durable. Use this for light to medium weight loads.



#### Woven Polypropylene

Our strongest material. This rigid weave will handle heavy items.

120 GSM PP WOVEN WITH LAMINATION  
PRINT 4 COLOUR PROCESS  
1"X24" PP WEBBING HANDLES - "X" STITCH

Many more sizes available - just ask!



**Create Your Own Look:**  
Choose your bag style. Send us your artwork. For 100% full colour design, speak to your sales representative.

- Minimum quantity 2,000 per size
- Estimated lead time: 14 - 16 weeks for printed items from approved art.



CODE	DESCRIPTION	SIZE (inches)	CASE PACK	PRICE/EACH	
				100+	1000+
A	21141615B Black Tote with 4" gusset	14 x 4 x 16 x 4	100	\$2.25	\$1.60
B	21111315BW Six Bottle Wine Tote	11.5 x 7.25 x 13 x 7.25	100	\$3.17	\$3.05
C	21141655B Black Tote with 8" gusset	14 x 8 x 16 x 8	100	\$2.43	\$1.77
D	21141609R Red Tote with 8" gusset	14 x 8 x 16 x 8	100	\$2.46	\$1.81
E	21141675C Large Kraft Composite Tote	14 x 6 x 16 x 6	100	\$2.58	-
F	21081075C Small Kraft Composite Tote	8 x 4 x 10 x 4	100	\$1.72	-

**FOIL PRINT**  
100+ 35¢ each  
1000+ 32¢ each  
2500+ 26¢ each

**SCREEN PRINT**  
100+ \$1.25 each  
500+ \$1.08 each  
1000+ 90¢ each

**TRANSFER PRINT**  
100+ \$2.45 each  
1000+ \$2.25 each  
300 bags minimum

Estimated lead time:  
2 - 3 weeks for printed items from approved art.

# IN STOCK

## Non-Woven Garment Covers

Great for resale or promotions!

CODE	SIZE (inches)	CASE PACK	PRICE/EACH UNPRINTED
A 21244015	24 x 42	100	\$3.81
B 21245415	24 x 54	100	\$5.44
C 21247215	24 x 72 + 4	100	\$8.96

Silk screen set-up charge: \$75.00

Please allow 2-3 weeks for printed items from approved art.



**SCREEN PRINT**  
 100+ \$1.25 each  
 500+ \$1.08 each  
 1000+ 90c each

SCAN THIS CODE ON YOUR PHONE TO ORDER



A

Suit Bag 24" x 42"

B

Coat Bags 24" x 54"

C

Gown Bags  
 24" x 72" + 4"  
 gusset all around

LOOP FOR FOLDING OVER

**In Stock**  
 One roll, white with no print  
**\$373.75 any size**  
 21214000S, 21215400S, 21217300S



## CREATE YOUR OWN LOOK

## Non-Woven Garment Covers

Custom Colours Available

SIZE	DESCRIPTION
24 x 42	Suit Bag
24 x 54	Coat Bag
24 x 72 + 4	Gown - Black

Please allow 14 - 16 weeks from approved art for delivery.  
 Minimum 1000 per size.

Pricing includes printing on one side with one colour.

## BOXES GIFT AND APPAREL



# IN STOCK

# IN STOCK

GIFT AND APPAREL BOXES

## Rigid Collapsible Boxes



**New**



Ships flat and assembles without the use of peel and stick tape.

- 100% recyclable gift box
- 70% less storage space than rigid box
- Keepsake

CODE	DESCRIPTION	SIZE (in)	CASE PACK	PRICE/EACH	
				50+	500+
45090800	Small	9.25 x 8.5 x 4.25	50	\$4.94	\$4.35
45141000	Medium	14.5 x 10.5 x 4.25	50	\$6.04	\$5.41
45161200	Large	16 x 12 x 6.25	50	\$8.47	\$7.56



All 3 sizes fit inside our 3 sizes of Gift Ecomm boxes.

Please allow 3-5 weeks for printed items from approved art.

**FOIL PRINT**  
Exterior and interior lid  
40/60/100+ 35¢ each  
1000+ 32¢ each  
2500+ 26¢ each

**DIGITAL PRINT**  
1-499 62¢ each  
500-999 40¢ each  
1000+ 35¢ each

**INK PRINT**  
25/50/100+ 34¢ each  
1000+ 29¢ each  
2500+ 24¢ each



## White Foldings

- Our most economical option ships flat and stores flat
- Please allow 2 - 3 weeks for printed items from approved art



Please allow 2 - 3 weeks for printed items from approved art.

**FOIL PRINT**  
50/100+ 35¢ each  
1000+ 32¢ each  
2500+ 26¢ each

**INK PRINT**  
50/100+ 34¢ each  
1000+ 29¢ each  
2500+ 24¢ each

CODE	DESCRIPTION	SIZE (inches)	CASE	PRICE/EACH	
				100+	1000+
32058003	G58	Baby Mugs	3.5 x 3.5 x 2	100	\$0.27 \$0.24
32001003	G1	Mugs	4 x 4 x 4	100	\$0.29 \$0.25
32002003	G2	Cups and Saucers	6 x 6 x 4	100	\$0.41 \$0.36
32043003	G43	Bowls, etc.	10 x 8 x 4	100	\$0.55 \$0.51
32033003	G33	Bowls, etc.	10 x 10 x 6	100	\$1.35 \$1.18
32005003	G5	Teapots, etc.	8 x 8 x 5	100	\$0.82 \$0.74
32006003	G6	Teapots, etc.	8 x 8 x 8	100	\$1.21 \$1.09
32048003	G48	Fork, Knife, Spoon	13 x 4 x 2	100	\$1.45 \$1.31
32036003	G36	Casseroles	11 x 11 x 4.5	100	\$1.35 \$1.18
32013003	G13	Plates	5 x 5 x 2	100	\$0.39 \$0.33
32004003	G4	Plates	8 x 8 x 2	100	\$0.70 \$0.60
32008003	G8	Plates	11 x 11 x 2	100	\$0.84 \$0.74
32009003	G9	Plates	13.5 x 13.5 x 2	100	\$1.14 \$1.05
32040003	G40	Plates	15 x 15 x 2	100	\$1.48 \$1.34
32003003	G3	All purpose	7 x 4 x 3	100	\$0.49 \$0.44
32010003	G10	All purpose	9 x 4.5 x 4.5	100	\$0.54 \$0.48
32038003	G38	All purpose	12 x 4 x 4	100	\$0.68 \$0.62
32041003	G41	All purpose	10 x 7 x 7	100	\$1.05 \$0.99
32224003	G24*	2-Piece Boxes - Base	6 x 6 x 10	100	\$0.73 \$0.66
32124003	G24*	2-Piece Boxes - Lid		100	\$0.73 \$0.66

\* Must be ordered together. Pricing shown is for base and lid combined.



## Apparel Boxes

- Minimum order quantity is one case pack
- Please allow 2 - 3 weeks for printed in stock boxes from approved art

IN STOCK COLOURS



SPECIAL ORDER COLOUR

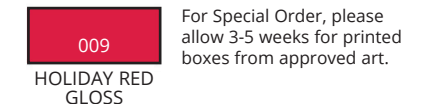

CODE	DESCRIPTION	CASE SIZE (inches)	PACK	WHITE PRICE /EACH		KRAFT PINSTRIPE PRICE/EACH		COLOURS PRICE/EACH	
				100+	1000+	100+	1000+	100+	1000+
A 32072	Glove/Sock*	11.5 x 5.5 x 1.5	100	\$1.51	\$1.26	\$1.68	\$1.40	—	—
B 32073	Lingerie/T-Shirt	11.5 x 8.5 x 1.625	100	\$1.70	\$1.41	\$1.75	\$1.46	\$3.07	\$2.56
C 32075	Shirt	15 x 9.5 x 2	100	\$1.86	\$1.55	\$1.98	\$1.65	\$4.27	\$3.56
D 32076	Sweater/Dress	17 x 11 x 2.5	50	\$3.15	\$2.62	\$3.32	\$2.76	\$5.94	\$4.95
E 32077	Jacket/Robe	19 x 12 x 3	50	\$4.19	\$3.49	\$3.89	\$3.37	\$6.85	\$5.93
F 32078	Coat/Gown**	24 x 14 x 4	25	\$6.68	\$5.78	\$7.01	\$6.07	\$10.31	\$8.93
G 32071	Sweater (white only)	15 x 11 x 4.5	50	\$5.05	\$4.37	—	—	—	—

**FOIL PRINT**  
25/50/100+ 35¢ each  
1000+ 32¢ each  
2500+ 26¢ each

**INK PRINT**  
25/50/100+ 34¢ each  
1000+ 29¢ each  
2500+ 24¢ each

\* Kraft pinstripe and White only \*\* Not available in Black

Please allow 2 - 3 weeks for printed in stock boxes from approved art.

All print orders subject to set-up charges. Applicable artwork, and plate charges may apply. See page 98.

All print orders subject to set-up charges. Applicable artwork, and plate charges may apply. See page 98.

# SPECIAL ORDER

## Malibu Magnetic Closure Gift Box

Dual purpose - great for gifting and use after.  
Perfect for e-commerce business subscriptions.

- Smooth paper covering
- Magnetic closures
- Three colours and three sizes
- Inserts available via special order. Ask your representative



CODE	DESCRIPTION	SIZE (in)	CASE PACK	PRICE/EACH 40+
454103 __	Small	8.5 x 2.75 x 1.625	100	\$3.78
454104 __	Medium	7.25 x 5.5 x 1.375	60	\$5.18
454116 __	Large	10.75 x 7.125 x 1.625	40	\$6.15

Please allow 3-5 weeks for printed items from approved art.



**FOIL PRINT**  
Exterior and interior lid  
40/60/100+ 35¢ each  
1000+ 32¢ each  
2500+ 26¢ each

SCAN THIS CODE ON YOUR PHONE TO ORDER



## Tuckit® Folding Gift Boxes

- One piece boxes fold and tuck together for a solid bottom
- 18 sizes available • 100% recycled content (min. 35% post consumer) - kraft excluded



Bottom tucks into place for a secure fit.



CODE	SIZE (inches)	CASE PACK	ECONO WHITE PRICE/EACH		KRAFT PRICE/EACH		GLOSS COLOURS PRICE/EACH	
			100+	1000+	100+	1000+	100+	1000+
334103 __	3 x 3 x 2	100	\$0.56	\$0.51	\$0.49	\$0.45	N/A	N/A
334180 __	3 x 3 x 3	100	\$0.49	\$0.45	\$0.52	\$0.47	N/A	N/A
334111 __	4 x 4 x 4	100	\$0.65	\$0.59	\$0.64	\$0.58	\$1.15	\$1.05
334115 __	6 x 4.5 x 4.5	100	\$0.95	\$0.86	\$0.99	\$0.90	\$1.47	\$1.34
334113 __	6 x 6 x 4	100	\$1.25	\$1.13	\$1.25	\$1.13	\$2.01	\$1.83
334114 __	6 x 6 x 6	100	\$1.36	\$1.23	\$1.59	\$1.45	\$1.93	\$1.76
334120 __	8 x 8 x 3.5	100	\$2.13	\$1.93	\$2.18	\$1.98	\$3.06	\$2.79
33412100	8 x 8 x 6	50	\$3.17	\$2.64	N/A	N/A	N/A	N/A
33412200	8 x 8 x 8.5	100	\$3.65	\$3.04	N/A	N/A	N/A	N/A
334119 __	9 x 4.5 x 4.5	100	\$1.31	\$1.19	\$1.45	\$1.32	\$2.01	\$1.83
334183 __	10 x 5 x 4	100	\$1.36	\$1.24	\$1.23	\$1.12	N/A	N/A
* 334124 __	10 x 10 x 6	50	\$3.77	\$3.43	\$4.07	\$3.70	\$6.04	\$5.49
* 334131 __	12 x 6 x 6	50	\$2.30	\$2.09	\$2.07	\$1.88	\$2.63	\$2.40
* 334125 __	12 x 12 x 2.5	50	\$2.65	\$2.41	\$3.72	\$3.39	\$3.84	\$3.49
* 334136 __	12 x 12 x 5.5	50	\$4.55	\$4.14	\$5.07	\$4.61	\$3.38	\$3.08
334186 __	14 x 6 x 6	50	\$3.34	\$3.04	\$3.89	\$3.53	N/A	N/A
33414500	14 x 14 x 5	25	\$5.49	\$4.99	N/A	N/A	N/A	N/A
33416700	16 x 16 x 7	25	\$7.51	\$6.83	N/A	N/A	N/A	N/A

\* not available in Gloss Black

100% recycled content (min. 35% post consumer) - kraft excluded

Please allow 3 - 5 weeks for printed items from approved art.



**FOIL PRINT**  
50/100+ 35¢ each  
1000+ 32¢ each  
2500+ 26¢ each

SCAN THIS CODE ON YOUR PHONE TO ORDER



## E-Commerce BOXES AND MAILER ENVELOPES



All print orders subject to set-up charges. Applicable artwork, and plate charges may apply. See page 98.

All print orders subject to set-up charges. Applicable artwork, and plate charges may apply. See page 98.

# CREATE YOUR OWN LOOK

Eco-Friendly, Recyclable  
E-Commerce Packaging



## Custom E-Commerce Gift Boxes

Go above and beyond to impress customers and exceed their expectations by delivering more than just a product, but also an experience.

- Please allow 12 - 14 weeks for printed items from approved art

### SIZE (inches)

10 x 6 x 4
11.125 x 8.75 x 4
14.5 x 7.25 x 5
17 x 12 x 4.25
17.125 x 11.125 x 2

**NO PLATE CHARGES!**

## Custom Poly Mailers

- 2.0 mil co-extruded LDPE film
- White exterior with black interior
- 2" adhesive lip
- Plate charges apply
- Please allow 12 - 14 weeks for printed items from approved art

### SIZE (inches)

9 x 12 + 2
12 x 15 1/2 + 2
14 1/2 x 19 + 2
19 x 24 + 2

### OTHER TYPES OF MAILERS AVAILABLE:

Product Description	Minimum Qty
Recycled Poly Mailers	25,000+
Padded Paper Mailers	40,000+
Paper Apparel Mailers	10,000+
Rigid Paper Mailers	10,000+
Bubble Poly Mailers	25,000+



50% Recycled Shell  
Made in the US

### Ask Your Representative For Details On Personalizing Your E-Commerce Mailers

10,000 minimum  
1, 2 or 4 colour process. One or both sides



### Create Your Own Look:

Choose your box style.  
Send us your artwork.  
For 100% full colour design, speak to your sales representative.

# IN STOCK

Available for immediate shipment.

Deliver the 'in-store' experience to your customer's door.



## Gift and Apparel Ecommerce

- Reversible kraft with oyster or black interior
- Sturdy E Flute for safe delivery in 3 sizes
- Pack flat with 50 pieces/carton

SCAN THIS CODE ON YOUR PHONE TO ORDER



CODE	SIZE (inches)	CASE	OYSTER/KRAFT PRICE/EACH			BLACK/KRAFT PRICE/EACH		
			50+	500+	1000+	50+	500+	1000+
451009 ___	10.25 x 9.062 x 4.375	50	\$2.34	\$2.08	\$1.87	\$2.77	\$2.46	\$2.22
451511 ___	15.562 x 11.062 x 4.562	50	\$3.33	\$2.81	\$2.55	\$3.88	\$3.28	\$2.93
451612 ___	16.937 x 12.625 x 6.5	50	\$4.31	\$3.89	\$3.45	\$4.96	\$4.47	\$3.96

\*Kraft and White sides only for Digital Print.  
Add a customized In Stock Seal. See page 94.  
Add a Special Order Full Colour Seal. See page 96.



**DIGITAL PRINT**  
Only on white and kraft.  
1-499 62¢ each  
500-999 40¢ each  
1000+ 35¢ each

SCAN THIS CODE ON YOUR PHONE TO ORDER



## Jewellery Ecommerce For Geo and Horizon packaging.

- Reversible kraft boxes with black or metallic bronze interior
- Black flock inserts available to fit Horizon and Geo jewellery packaging\*
- Minimum case pack 25

CODE	DESCRIPTION	SIZE (inches)	PRICE/EACH		
			25+	250+	1000+
450505 ___	Small Ecom Box	5.75 x 5.75 x 2.5	\$1.54	\$1.46	\$1.22
451010 ___	Large Ecom Box	10.25 x 10.25 x 2.5	\$3.08	\$2.83	\$2.56
<b>Horizon Inserts</b>					
69221003H	Ring to fit small box		\$0.57	\$0.52	\$0.38
69632003H	T-pad to fit small box		\$0.57	\$0.52	\$0.38
69684003H	Utility to fit small box		\$0.57	\$0.52	\$0.38
69693003H	Bracelet to fit large box		\$0.93	\$0.74	\$0.66
<b>Geo Inserts</b>					
69221153G	Ring to fit small box		\$0.57	\$0.52	\$0.38
69283153G	T-pad to fit small box		\$0.57	\$0.52	\$0.38
69293153G	Bracelet to fit large box		\$0.93	\$0.74	\$0.66
69273153G	Necklace to fit large box		\$0.93	\$0.74	\$0.66

Add a customized In Stock Seal. See page 94.  
Add a Special Order Full Colour Seal. See page 96.

All print orders subject to set-up charges. Applicable artwork, and plate charges may apply. See page 98.

# IN STOCK

## Recyclable Ecommerce Mailer

- Natural brown kraft paper
- 150 gsm recycled paper - 40% PCW
- Strong and flexible with 3" gussets
- 1 sku - customizable to sizes



CODE	SIZE (inches)	CASE PACK	PRICE/EACH	
			200+	1000+
52524512	20.5 x 3 x 17.75	200	\$1.03	\$0.91

FOIL PRINT		
200+	35c each	
1000+	32c each	
2500+	26c each	



Eco-Friendly – “Be Proud of the Way You Ship”

### A Recycled Poly Mailers

- IN STOCK -				
CODE	SIZE (in)	CASE	PRICE/EACH	
			1+	4+
52091286	9 x 12	1000	\$0.57	\$0.54
52101386	10 x 13	1000	\$0.60	\$0.57
52121586	12 x 15.5	500	\$0.79	\$0.75

- SPECIAL ORDER -				
CODE	SIZE (in)	CASE	PRICE/EACH	
			1+	4+
52060986	6 x 9	1000	\$0.41	\$0.39
52071086	7.5 x 10.5	1000	\$0.48	\$0.45
52141986	14.5 x 19	250	\$1.33	\$1.26
52192486	19 x 24	125	\$2.16	\$2.04
52242486	24 x 24	125	\$2.92	\$2.77

### B Padded Paper Mailers

- IN STOCK -				
CODE	SIZE (in)	CASE	PRICE/EACH	
			1+	4+
52060976	6 x 9	250	\$0.87	\$0.83
52081176	8.5 x 11	100	\$1.38	\$1.31

- SPECIAL ORDER -				
CODE	SIZE (in)	CASE	PRICE/EACH	
			1+	4+
52101576	10.5 x 15	2 100	\$2.04	\$1.93

### C Paper Apparel Mailers

- IN STOCK -				
CODE	SIZE (in)	CASE	PRICE/EACH	
			1+	4+
52101375	10 x 13	250	\$1.46	\$1.39
52121575	12 x 15.5	150	\$1.96	\$1.85
52101975	10.5 x 4 x 19	100	\$2.32	\$2.20

- SPECIAL ORDER -				
CODE	SIZE (in)	CASE	PRICE/EACH	
			1+	4+
52070975	7 x 9	250	\$0.95	\$0.90

### D Rigid Paper Mailers

- IN STOCK -				
CODE	SIZE (in)	CASE	PRICE/EACH	
			1+	4+
52061012	6 x 10	500	\$0.68	\$0.65
52061212	6 x 2.5 x 12	500	\$0.98	\$0.93
52091412	9.5 x 14.5	250	\$1.19	\$1.12

- SPECIAL ORDER -				
CODE	SIZE (in)	CASE	PRICE/EACH	
			1+	4+
52081212	8.5 x 12	250	\$0.90	\$0.85
52101612	10.5 x 16	250	\$1.43	\$1.35
52121912	12.5 x 19	250	\$1.62	\$1.53

For more product information on recyclability and material content, visit [gunthermele.com](http://gunthermele.com)

### E Bubble Poly Mailers

- SPECIAL ORDER - NO PRINT				
CODE	SIZE (in)	CASE	PRICE/EACH	
			1+	4+
52040600	4 x 6.75	500	\$0.63	\$0.59
52060800	6.5 x 8.75	250	\$0.71	\$0.67
52081000	8.5 x 10.75	100	\$1.06	\$1.01

Custom printing available. Minimum 25,000 quantities.



FOIL PRINT		
100+	35c each	
1000+	32c each	
2500+	26c each	

PAD PRINT		
100+	35c each	
1000+	32c each	
2500+	26c each	

INK PRINT		
100+	34c each	
1000+	29c each	
2500+	24c each	



All print orders subject to set-up charges. Applicable artwork, and plate charges may apply. See page 98.

# FINISHING TOUCHES

## RIBBON, TISSUE, WRAP AND SEALS



All print orders subject to set-up charges. Applicable artwork, and plate charges may apply. See page 98.

# IN STOCK

## Inspirations Gift Wrap

Inspirations  
Giftwrap

By Gunther Mele

Available for immediate shipment.



Inspirations  
Giftwrap

By Gunther Mele

Available for immediate shipment.



# IN STOCK

## Inspirations Gift Wrap

GIFT WRAP

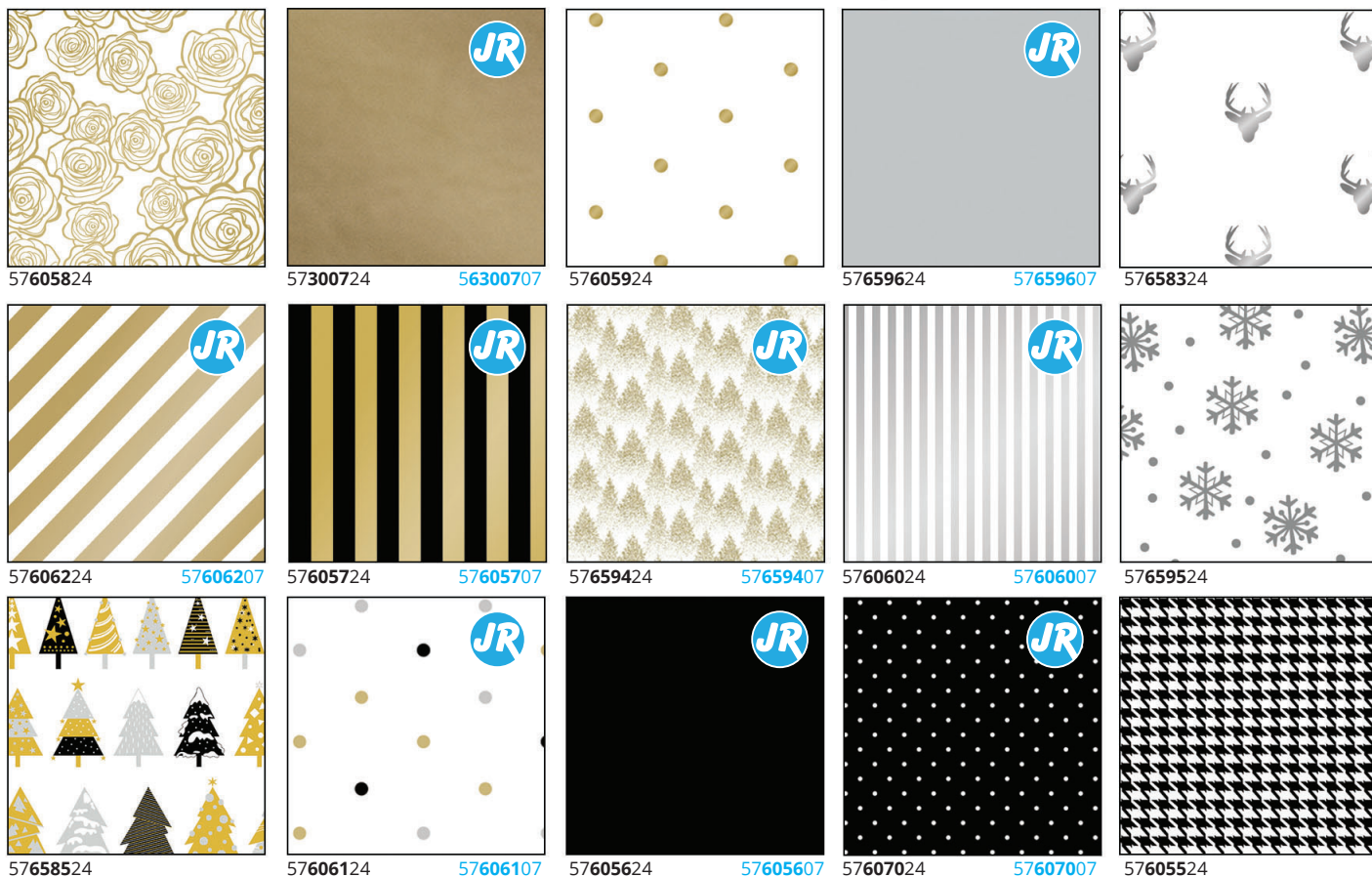

24" x 417' - 1/2 Ream Roll  
**\$109.07** Code # 57 \_\_\_\_ 24  
each

8" x 150' - Jewellers Rolls **\$44.52** Code # 57 \_\_\_\_ 07  
each

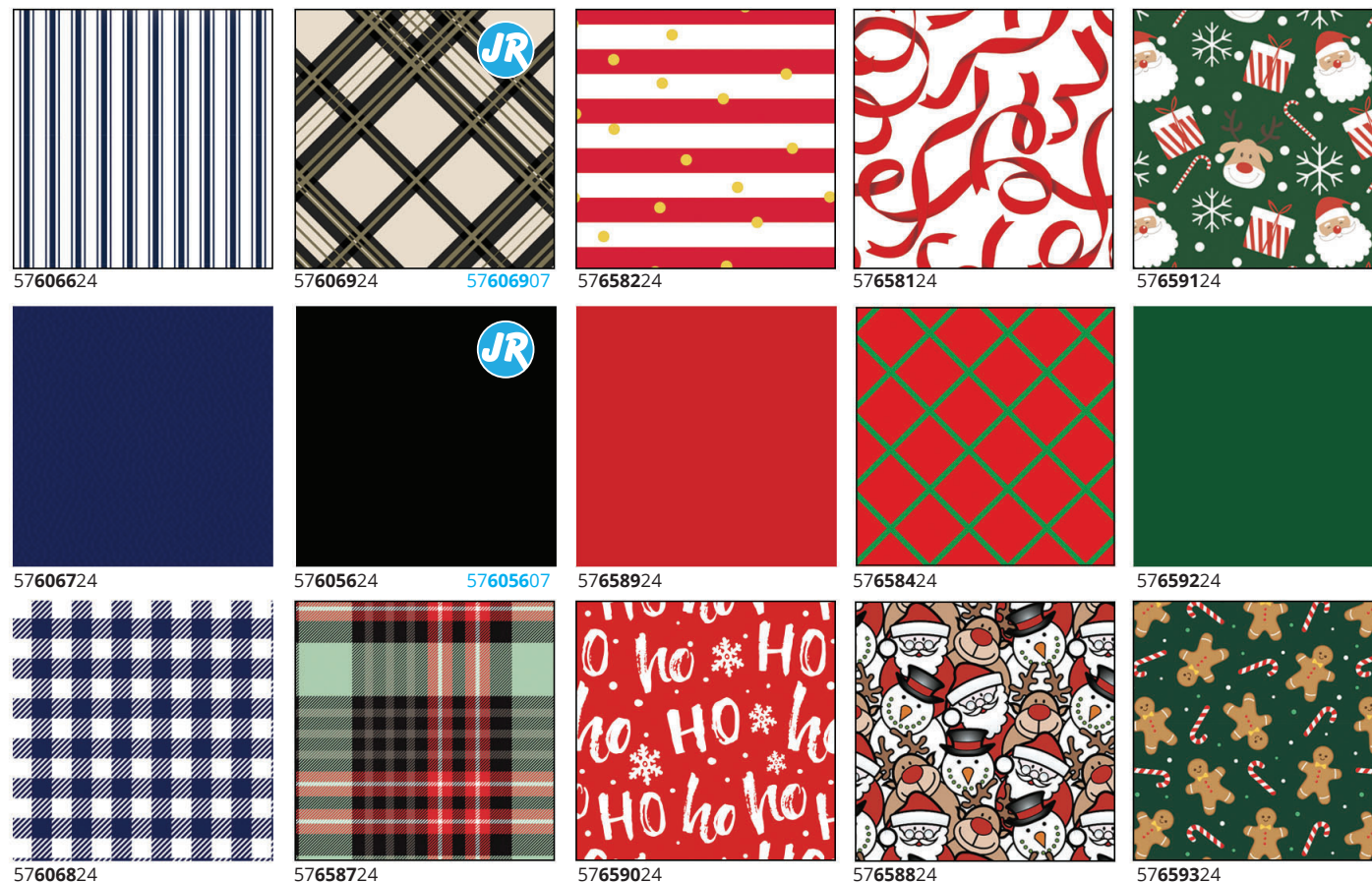

24" x 417' - 1/2 Ream Roll  
**\$109.07** Code # 57 \_\_\_\_ 24  
each

8" x 150' - Jewellers Rolls **\$44.52** Code # 57 \_\_\_\_ 07  
each

# SPECIAL ORDER

Sullivan Designs

Please allow 4 - 6 weeks for shipment.

GIFT WRAP

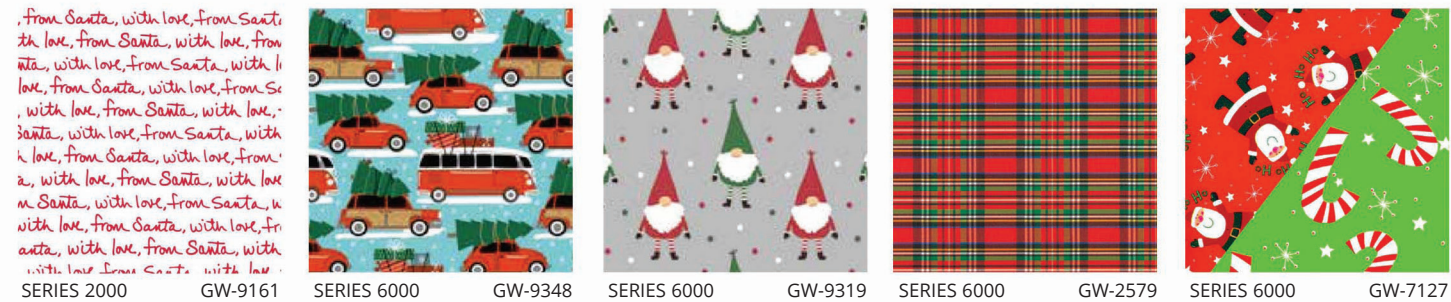

SERIES 2000 GW-9161    SERIES 6000 GW-9348    SERIES 6000 GW-9319    SERIES 6000 GW-2579    SERIES 6000 GW-7127



SERIES 9500 GW-9178    SERIES 6000 GW-0737    SERIES 9000 GW-9109    SERIES 6000 GW-9368    SERIES 6000 GW-9005

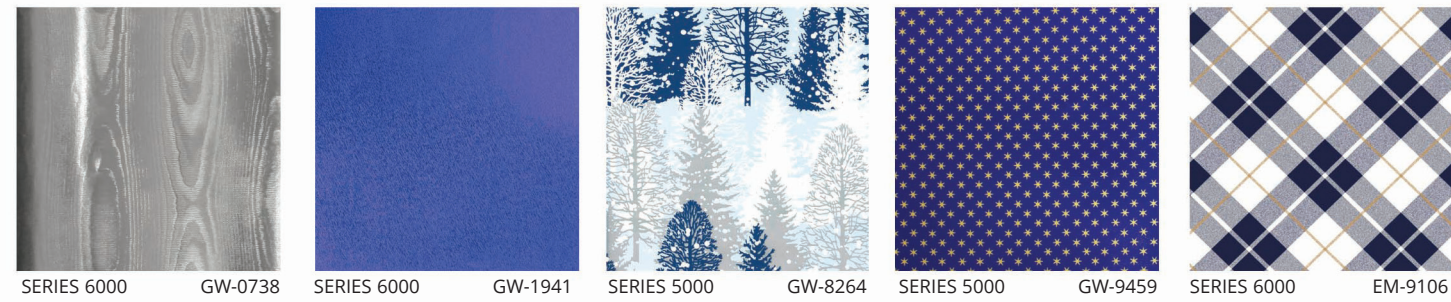

SERIES 6000 GW-0738    SERIES 6000 GW-1941    SERIES 5000 GW-8264    SERIES 5000 GW-9459    SERIES 6000 EM-9106

# SPECIAL ORDER

Sullivan Designs

Please allow 4 - 6 weeks for shipment.

GIFT WRAP



SERIES 2000 GW-7301    SERIES 5000 GW-9432    SERIES 6000 GW-9437    SERIES 6000 GW-9021    SERIES 6000 GW-9441



SERIES 2000 GW-0407    SERIES 6000 GW-1519    SERIES 2000 GW-9464    SERIES 6000 GW-1518    SERIES 9000 GW-8387

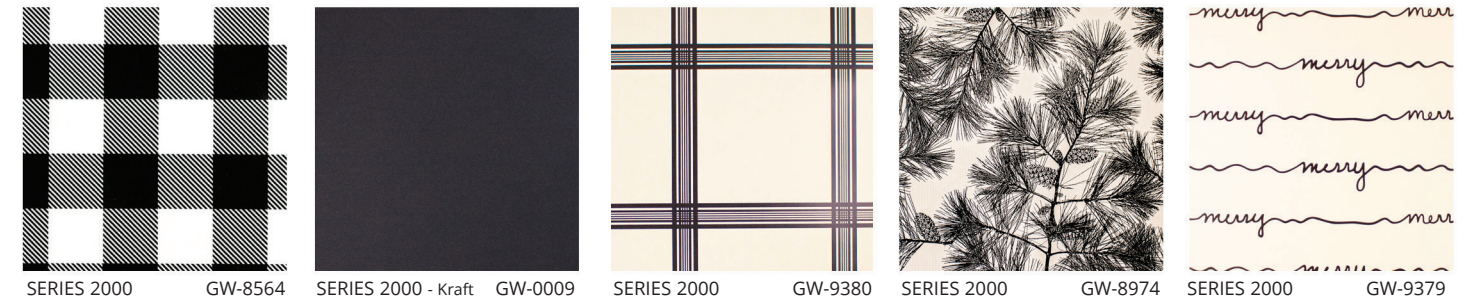

SERIES 2000 GW-8564    SERIES 2000 - Kraft GW-0009    SERIES 2000 GW-9380    SERIES 2000 GW-8974    SERIES 2000 GW-9379

Additional custom order designs available to choose from. Contact your area sales representative for more info.

## SULLIVAN designs available in 1/2 Ream Rolls and Full Ream Rolls

NOTE: All Sullivan gift wrap orders must include GW design code.

MINIMUM ORDER: 1 Roll per design (15" rolls must be ordered in multiples of 2 rolls per design)

SLITTING CHARGE: A slitting charge of \$25.00 applies to each individual roll. No more than two slits per roll; (2 slits = \$25.00)

	15H	24H	30H	15F	24F	30F
Pricing Level	Half Ream 15" x 417'	Half Ream 24" x 417'	Half Ream 30" x 417'	Full Ream 15" x 833'	Full Ream 24" x 833'	Full Ream 30" x 833'
1000 Series	\$135.32	\$209.60	\$241.15	\$222.27	\$352.37	\$415.05
2000 Series	\$170.89	\$295.03	\$314.72	\$297.61	\$484.80	\$568.15
5000 Series	\$215.13	\$347.63	\$400.20	\$381.06	\$627.05	\$732.06
6000 Series	\$253.28	\$414.18	\$476.53	\$459.60	\$746.47	\$884.84
7500 Series	\$249.79	\$410.12	\$472.26	\$454.85	\$758.11	\$882.38
9000 Series	\$296.18	\$487.94	\$562.30	\$543.08	\$907.68	\$1056.10
9500 Series	\$326.97	\$541.43	\$623.89	\$604.82	\$1014.79	\$1179.59

View our entire Selection online at [GUNTHERMELE.COM](http://GUNTHERMELE.COM)

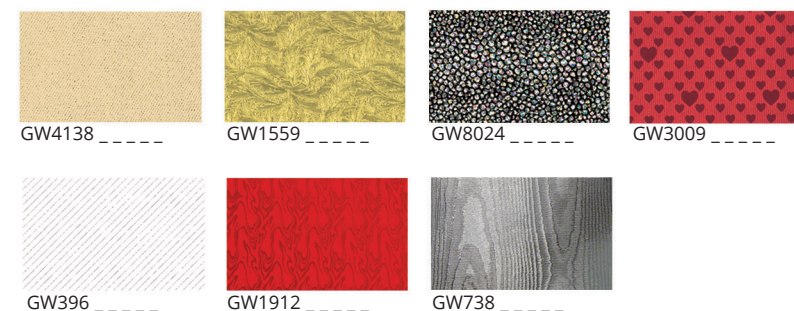

**Jewellers Rolls**

Size: 7.375" x 150'

**\$86.89/roll**

Minimum order 1 roll.  
JRX150 - Jeweller Roll suffix code.



Gift wrap dispenser with serrated edge can be added to your custom jewellers roll order for \$8.26 each. Code: 09715000

# CREATE YOUR OWN LOOK

• Please allow 6 - 8 weeks for printed items from approved art.



**Printed Tissue:** Pick a PMS print colour and we will match it.

– See page 87 for Special Order Tissue Colours!

CODE	DESCRIPTION	SIZE (in)	PACKAGED	PRICE/EACH	
				10 REAMS	30 REAMS
20869000G	White	20 X 30	480	\$119.46	\$103.36
20869000M	Coloured	20 x 30	480	\$171.24	\$148.17
20869000GK	Kraft	20 x 30	480	\$119.46	\$103.36
20869001M	Metallic SS*	20 x 30	200	\$283.39	\$268.74

\* SS - single sided

Print included in price of tissue.

Minimum 10 reams. Note: Plates extra \$310.00 (per colour).  
Ships in approximately 6 - 8 weeks.

For metallic ink print: add 10% to the price above.  
For > 50% ink coverage, an additional \$10 per ream.  
All custom orders subject to a +/-10% over/under run.

Custom Printed  
White Tissue – 10 Reams  
**\$1194.60**

# IN STOCK

Available for immediate shipment.

## Spotlight Tissue Colours

CODE	DESCRIPTION	SIZE (in)	PKG	PRICE/EACH		
				1 - 4	5+	25+
20819290S	White Economy	19 x 29	480	\$21.81	\$18.70	\$15.58
208551_G	Spotlight on Value (colours)	20 x 30	480	\$41.72	\$39.74	\$39.74
208559_G	Spotlight on Value (metallic)	20 x 30	200	\$75.13	\$73.73	\$72.34
20850102	#1 White Economy	19 x 14.5	480	\$10.00	\$8.75	\$7.19
20851800	#1 White Bleached	18 x 9 dia.	1 roll	\$124.66/roll		
20852000	#1 White Bleached	20 x 9 dia.	1 roll	\$154.26/roll		

10 in stock tissue colours to choose from.  
Plus check out our assorted Pre-Pack!

SCAN THIS CODE ON YOUR PHONE TO ORDER



14 DANDELION	16 ORANGE	19 BRIGHT LIME	56 ZIPPY GRAPE	60 EMERALD	21 HOT PINK	07 GOLD
66 BURGUNDY	* Hot Pink (21) and Burgundy (66) are \$55.23/each				08 SILVER	

# SPECIAL ORDER

## Unprinted Tissue

Unprinted, minimum 1 ream (per colour).  
Ships in approximately 4 - 6 weeks.

CODE	DESCRIPTION	SIZE (in)	Packaged	PRICE/REAM	
				1 REAM	25+ REAMS
20899_--	Special Order Colours	20 x 30	480 sheets	\$56.27	\$49.36

NE-100 LIGHT PINK	NE-110 PINK	NE-120 CORAL ROSE	NE-124 AZALEA	NE-126 SCARLET	NE-130 RED	NE-131 DEEP SCARLET	NE-145 FUCHSIA	NE-148 HOT PINK	NE-150 CERISE	NE-155 ZIPPY GRAPE
NE-160 PURPLE	NE-164 SANDSTONE	NE-165 BURGUNDY	NE-170 DUBONNET	NE-190 PEACH	NE-195 TANGERINE	NE-200 ORANGE	NE-210 LIGHT YELLOW	NE-220 YELLOW	NE-222 DANDELION	NE-223 OATMEAL
NE-226 POPPY	NE-230 GOLDENROD	NE-235 PISTACHIO	NE-246 EMERALD	NE-247 JADE	NE-245 PALE MINT	NE-250 MID GREEN	NE-251 GROOVY GREEN	NE-255 BRIGHT LIME	NE-265 TEAL	NE-266 BALSAM
NE-269 OASIS GREEN	NE-270 DARK GREEN	NE-273 FESTIVE GREEN	NE-274 CEDAR GREEN	NE-275 FOREST GREEN	NE-277 TAPESTRY GREEN	NE-278 AZURE	NE-279 OXFORD BLUE	NE-281 BLUE BREEZE	NE-300 TURQUOISE	NE-305 CERULEAN
NE-306 BRILLIANT BLUE	NE-308 SAPPHIRE	NE-310 DARK BLUE	NE-325 LILAC	NE-330 LAVENDER	NE-335 PERIWINKLE	NE-338 LILAC PERFUME	NE-340 PLUM	NE-341 RASPBERRY FIZ	NE-345 CRANBERRY	NE-347 CRÈME
NE-350 FRENCH VANILLA	NE-354 SHADOW GREY	NE-356 GRANITE	NE-357 NOBLE GOLD	NE-359 ESPRESSO	NE-360 DESERT TAN	NE-361 BERMUDA SAND	NE-362 TERRA COTTA	NE-366 BURNT SIENNA	NE-370 CHOCOLATE	NE-371 RAW SIENNA
NE-375 ANTIQUE BLUE	NE-382 COLONIAL BLUE	NE-385 NAVY BLUE	NE-386 MORNING MIST	NE-389 MOUNTAIN MIST	NE-390 GRAY	NE-400 BLACK	NE-410 BIRCH	NE-415 DUNE BEIGE	NE-417 PARCHMENT	

# IN STOCK

Available for immediate shipment.

## Curling Ribbon

See chart for available colours

CODE	PRICE/ROLL
<b>COLOURS - 3/16" x 500 yards</b> 148373 __	\$4.76
<b>METALLIC - 3/16" x 250 yards</b> 148378 __	\$12.88



## 2.75" Star Bows

See chart for available colours

CODE	CASE PACK	PRICE/EACH	1000+
<b>COLOURS - 2.75" x 17 loop</b> 142311 __	200	\$0.20	\$0.18
<b>METALLIC - 2.5" x 17 loop</b> 14531107 Gold	200	\$0.20	\$0.18
14531108 Silver	200	\$0.20	\$0.18

Min: case pack



## 3.75" Star Bows

See chart for available colours

CODE	CASE PACK	PRICE/EACH	1000+
<b>COLOURS - 3.75" x 13 loop</b> 143512 __	200	\$0.21	\$0.19
<b>METALLIC - 3.75" x 17 loop</b> 14551207 Gold	200	\$0.30	\$0.28
14551208 Silver	200	\$0.30	\$0.28

Min: case pack

## Splendor Ribbon

See chart for available colours

CODE	PRICE/ROLL
<b>COLOURS - 3/4" x 250 yards</b> 141050 __	\$13.087
<b>METALLIC - 3/4" x 100 yards</b> 14013007 Gold	\$17.43
14013008 Silver	\$17.43



99 - Everyday Assortment Star Bows  
Available in 2.75" and 3.75"



98 - Christmas Assortment Star Bows  
Available in 2.75" and 3.75"



Metallic Star Bows  
Available in 2.75" and 3.75"



RIBBONS

BOWS

# IN STOCK

Available for immediate shipment.

## Perfect Bows™

Minimum: 50 per size, per colour.

CODE	SIZE	PRICE/EACH	
		50+	1000+
140515 __	5.5" Perfect Bow	\$1.62	\$1.46



## Pull Bows

Minimum: 100 per size, per colour.

CODE	SIZE	STANDARD COLOURS		METALLIC COLOURS	
		100+	1000+	100+	1000+
132000 __	Petite 2" Bows	\$0.31	\$0.27	\$0.43	\$0.39
134000 __	Std. 4" Bows	\$0.52	\$0.47	\$0.73	\$0.67



## Mini Metallic Star Bows

252 per pack

CODE	DESCRIPTION	PRICE/PACK
14121099	Assorted	\$41.58
14121017	Gold	\$41.58
14121008	Silver	\$41.58



## Matte Wraphia™

CODE	SIZE	PRICE/ROLL
148367 __	100 yds	\$10.73

## Paper Roll/Ream Dispenser and Tape



CODE	DESCRIPTION	PRICE/EA
09850124	Paper Roll/Ream Roll dispenser - 24" rack	\$84.04

SCAN THIS CODE ON YOUR PHONE TO ORDER



## Ribbon Shredder

CODE:	09878600
PRICE:	\$9.04 each

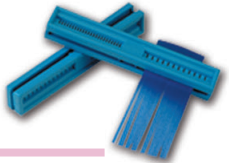

## Curling Ribbon Roll Dispenser

CODE:	09850100
PRICE:	\$136.35 each



Holds 12 Rolls

## Cellophane (1.0mil)

CODE	DESCRIPTION	SIZE	PRICE/ROLL
16400506	Clear Cellophane	40" x 100'	\$21.67



SCAN THIS CODE ON YOUR PHONE TO ORDER



Color # Name	Curling Ribbon	2.75" Star Bows	3.75" Star Bows	Splendor Ribbon
00 - White				
86 - Ivory				
29 - Vanilla				
61 - Pastel Yellow				
03 - Yellow				
13 - Daffodil				
14 - Sunshine Yellow				
07 - Gold				
08 - Silver				
27 - Holiday Gold				
22 - Melon				
73 - Coral				
16 - Tropical Orange				
17 - Orange				
12 - Chocolate				
75 - Baby Pink				
01 - Pink				
57 - Azalea				
09 - Hot Red				
58 - Lava Red				
66 - Burgundy				
41 - Beauty				
59 - Dubonnet Rose				
28 - Orchid				
05 - Lavender				
56 - Purple				
54 - Periwinkle				

Color # Name	Curling Ribbon	2.75" Star Bows	3.75" Star Bows	Splendor Ribbon
50 - Plum				
11 - Royal				
81 - Navy				
77 - Baby Blue				
02 - Light Blue				
47 - Aqua				
32 - Caribbean Blue				
55 - Robin's Egg				
25 - Turquoise				
71 - Sea Green				
18 - Celery				
74 - Spruce				
60 - Hunter				
84 - Teal				
04 - Mint				
19 - Citrus				
96 - Leaf				
30 - Celadon				
10 - Emerald				
70 - Antique Silver				
15 - Black				
07 - Metallic Gold				
08 - Metallic Silver				
09 - Metallic Red				
10 - Metallic Green				
99 - Everyday Assortment	N/A			N/A
98 - Christmas Assortment	N/A			N/A

# SPECIAL ORDER

RIBBON

## Unprinted Satin and Grosgrain Ribbon

See chart to the right for ribbon colours.



### Single Face Satin

WIDTH	CODE	PRICE/EA
3/8" x 100 yd roll	14031 ___	\$23.94
5/8" x 100 yd roll	14032 ___	\$25.68
7/8" x 100 yd roll	14033 ___	\$42.43
1-1/2" x 50 yd roll	14034 ___	\$31.82

### Grosgrain

WIDTH	CODE	PRICE/EA
3/8" x 100 yd roll	14160 ___	\$23.68
5/8" x 100 yd roll	14161 ___	\$28.70
7/8" x 100 yd roll	14162 ___	\$42.38
1-1/2" x 50 yd roll	14170 ___	\$27.53

1 roll minimum.

Lead time please allow 4-6 weeks for shipment. SPECIAL ORDER

## Printed Satin Ribbon

Enquire about our new selection of ribbon colors from your sales representative.



### Single Face Satin

WIDTH	CODE	PRICE/EA
3/8" x 100 yd roll	14150002	\$47.56
5/8" x 100 yd roll	14150003	\$50.88
7/8" x 100 yd roll	14150005	\$59.21
1-1/2" x 100 yd roll	14150015	\$95.11

(2 x 50 yd rolls)

500 yard minimum per width. Note: Plates extra \$94.00 (per colour).

### Foil Print Colours

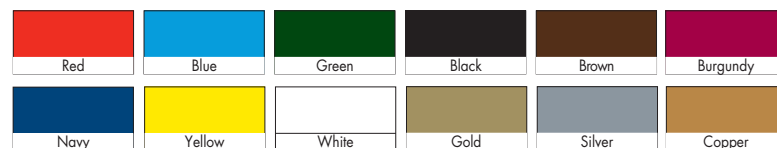

Contact your sales representative.



**FOIL PRINT**  
Included in price of ribbon

Please allow 3-4 weeks for printed items from approved art.

All print orders subject to set-up charges. Applicable artwork, and plate charges may apply. See page 98.

# SPECIAL ORDER

While we strive for accuracy in our catalogue, actual product may be slightly different than pictured.

Please allow 3-4 weeks for printed items from approved art.

RIBBON

3/8"		5/8"		7/8"		1-1/2"		COLOUR NUMBER AND NAME	3/8"		5/8"		7/8"		1-1/2"		COLOUR NUMBER AND NAME
Single Face Satin	Grosgrain	Single Face Satin	Grosgrain	Single Face Satin	Grosgrain	Single Face Satin	Grosgrain		Single Face Satin	Grosgrain	Single Face Satin	Grosgrain	Single Face Satin	Grosgrain	Single Face Satin	Grosgrain	
								029 - White									462 - Royal Orchid
								007 - Shell Grey									464 - Delphinium
								012 - Silver									465 - Purple
								015 - Grey									470 - Regal Purple
								022 - Pewter									473 - Amethyst
								028 - Antique White									528 - Lemon Grass
								813 - Oyster									530 - Mint
								016 - Portobello									533 - Jungle Green
								030 - Black									547 - New Chartreuse
								115 - Powder Pink									548 - Kiwi
								117 - Light Pink									550 - Apple Green
								150 - Pink									558 - Leaf
								156 - Hot Pink									567 - Spring Moss
								175 - Shocking Pink									570 - Moss
								187 - Azalea									580 - Emerald
								241 - Living Coral									586 - New Neon Green
								250 - Red									587 - Forest Green
								252 - Hot Red									617 - Baby Maize
								260 - Scarlet									640 - Lemon
								275 - Wine									645 - Daffodil
								277 - Burgundy									650 - Maize
								285 - Plum									660 - Yellow Gold
								305 - Light Blue									675 - Gold
								331 - Dusty Blue									690 - Old Gold
								312 - Blue									722 - Burnt Sienna
								315 - Navajo Turquoise									743 - Ginger
								329 - Cobalt									750 - Torrid Orange
								340 - Turquoise									789 - Sherry
								343 - Tornado Blue									790 - Currant
								350 - Royal									810 - Ivory
								352 - Electric Blue									815 - Cream
								353 - Century Blue									825 - Natural
								365 - Light Navy									835 - Tan
								370 - Navy									841 - Khaki
								412 - Purple Haze									850 - Brown
								430 - Light Orchid									866 - Coffee
								450 - Orchid									

# IN STOCK

In stock and ready to ship.

## Simply Sheer Asiana Ribbon

Monofilament-Edge



CODE	SIZE	PRICE/ROLL
149435 __	7/8" x 100 yards	\$16.82
149436 __	1 1/2" x 100 yards	\$18.56

• minimum order: one roll.



Can be special ordered in additional colours!

SCAN THIS CODE ON YOUR PHONE TO ORDER



# SPECIAL ORDER

Please allow 4 - 6 weeks for shipment.

## Contessa Ribbon

Wire-Edge  
Single Face Satin



CODE	SIZE	PRICE/ROLL
14163 __	1 1/2" x 25 yards	\$18.05
*14164 __	2 1/4" x 25 yards	\$27.08

• minimum order: one roll.



\* 2-1/4" is only available in 029-White, 260-Scarlet and 810-Ivory.

SCAN THIS CODE ON YOUR PHONE TO ORDER



## Encore Ribbon

Wire-Edge



CODE	SIZE	PRICE/ROLL
141650 __	5/8" x 25 yards	\$8.49
141660 __	1 1/2" x 25 yards	\$16.20
141670 __	2 1/2" x 25 yards	\$24.65

• minimum order: one roll.



\* not available in 5/8"  
† not available in 2 1/2"

SCAN THIS CODE ON YOUR PHONE TO ORDER



Please allow 4 - 6 weeks  
for printed items from  
approved art.

# CREATE YOUR OWN LOOK

## Raised Ink Printing

See chart below for ribbon colours.

Pick your own colours for raised print - NO PLATE CHARGE

Available in: 5/8" x 100 yd roll, 7/8" x 100 yd roll, 1-1/2" x 50 yd roll  
40 roll minimum for all printed ribbon.

**Sheer Ribbon Colours** All colours are available in all sizes. See page 90-91 for single face satin and grosgrain colour availability.



Single Face Satin Ribbon with Raised Print



Sheer Ribbon with Raised Print



Grosgrain Ribbon with Raised Print

# IN STOCK

# IN STOCK

SEALS

SEALS



**FOIL PRINT**  
Included in the price.  
Please allow 2-3 weeks for printing.



For a no-print solution, order our in stock embossed seals.



## Customized Seals-Foil Printed

CODE	One colour foil print/each SIZE	SPECIAL ORDER Two colour/each		SPECIAL ORDER Acetate 1 colour/each		SPECIAL ORDER Acetate 2 colour/each			
		2000+	5000+	2000+	5000+	2000+	5000+		
25 4 digit label code 2 digit label colour	A	\$0.12	\$0.10	\$0.1577	\$0.1242	\$0.1792	\$0.1393	\$0.2062	\$0.1598
	B	\$0.13	\$0.12	\$0.1685	\$0.1307	\$0.2149	\$0.1685	\$0.2473	\$0.1976
	C	\$0.15	\$0.14	\$0.1803	\$0.1501	\$0.2750	\$0.1977	\$0.2894	\$0.2354
	D*	\$0.17	\$0.15	\$0.1922	\$0.1598	\$0.3175	\$0.2538	\$0.3424	\$0.2743

\$80 plate charge

NO PLATE CHARGES

Label Colours Available:



\* D sized Seals and Clear print are SPECIAL ORDER.  
See foil chart on inside back cover of catalogue for available print colours.

## Pre-printed Labels

Available for immediate shipment.

CODE	SIZE	CASE	PRICE/EACH	
			1000+	5000+
25401007S	5/8 x 3/8"	1000	\$0.13	\$0.12
25401407S	5/8 x 3/8"	1000	\$0.13	\$0.12
25406208S	5/8 x 3/8"	1000	\$0.13	\$0.12
25401007V	3/4" oval	1000	\$0.13	\$0.12
25401407V	3/4" oval	1000	\$0.13	\$0.12
25406008V	3/4" oval	1000	\$0.13	\$0.12

1000/box minimum order - 1 box of 1000.

## Embossed Seals

Available for immediate shipment.

500/box min. order - 1 box.	CODE	SIZE	PRICE/EA
	Gold 08701207	1.5" dia.	\$0.09
	Silver 08701208	1.5" dia.	\$0.09

ACTUAL EMBOSSED PATTERN 1.5" DIA.

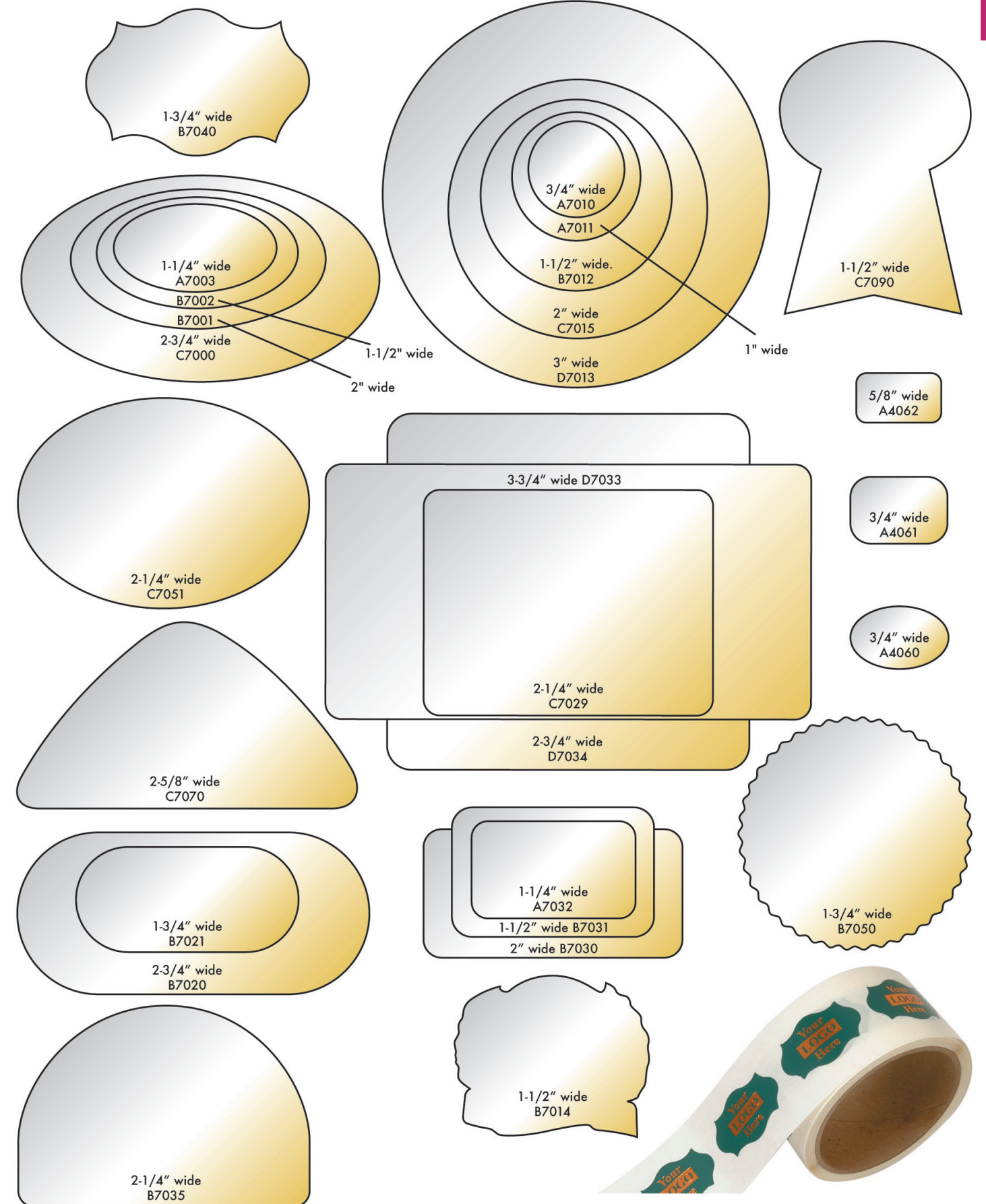
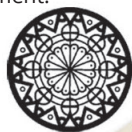

All print orders subject to set-up charges. Applicable artwork, and plate charges may apply. See page 98.

# SPECIAL ORDER

# SPECIAL ORDER

Please allow 4 - 6 weeks for printing from approved art. NO PLATE CHARGE!

## Custom Full Colour Seals

Full colour, edge to edge print.  
Thirty sizes to choose from.  
"Picture Perfect" Seals

Speak with  
your Sales  
Representative  
to order.

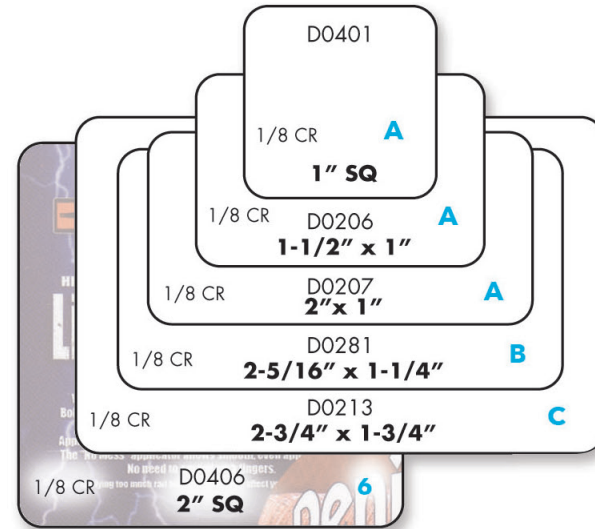

Please allow 4 - 6 weeks for printing from approved art.  
NO PLATE CHARGE!

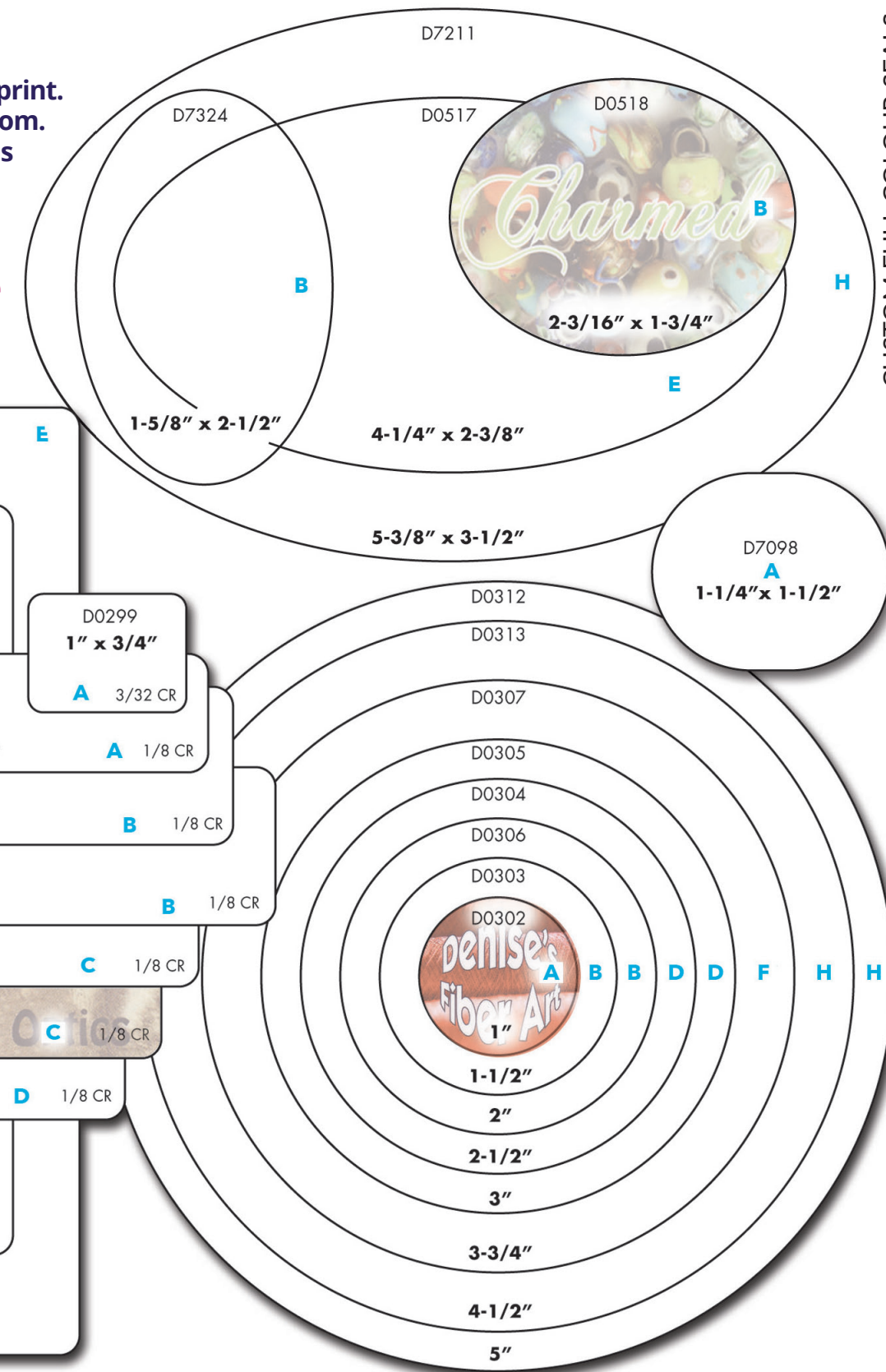
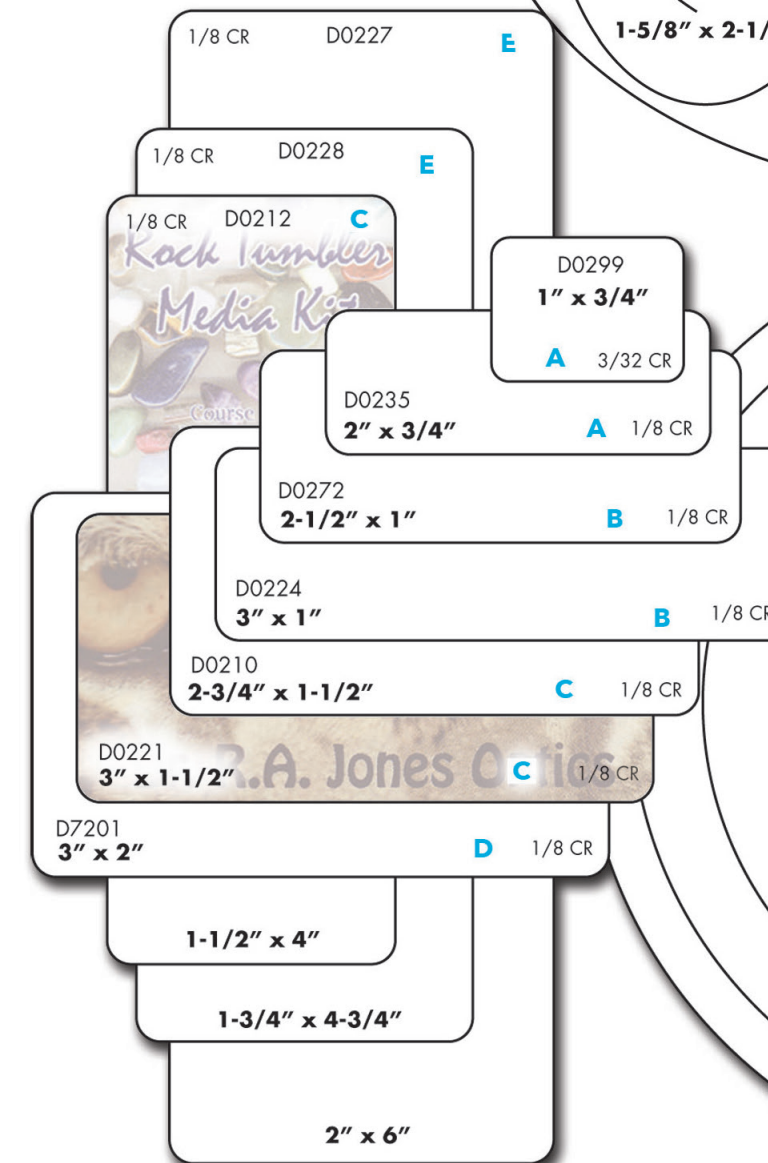
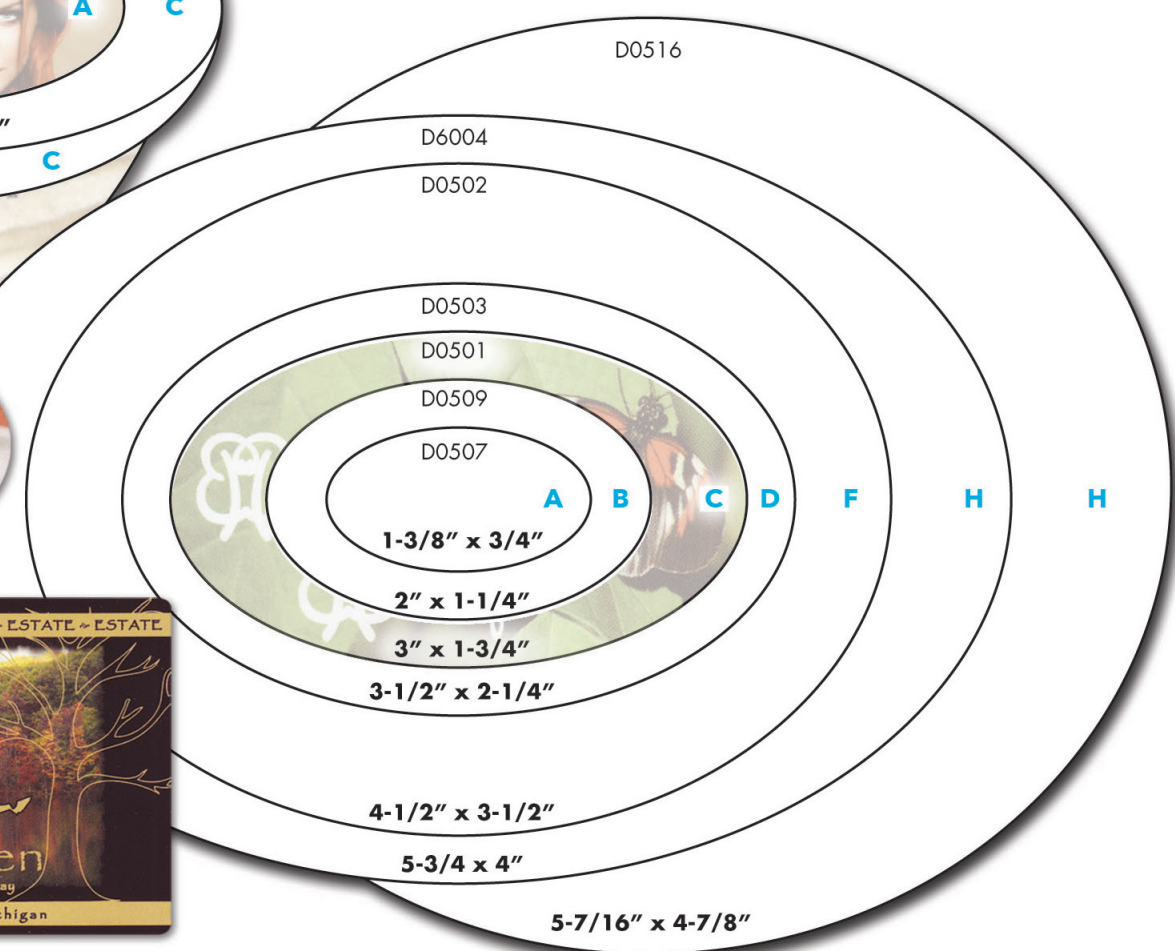
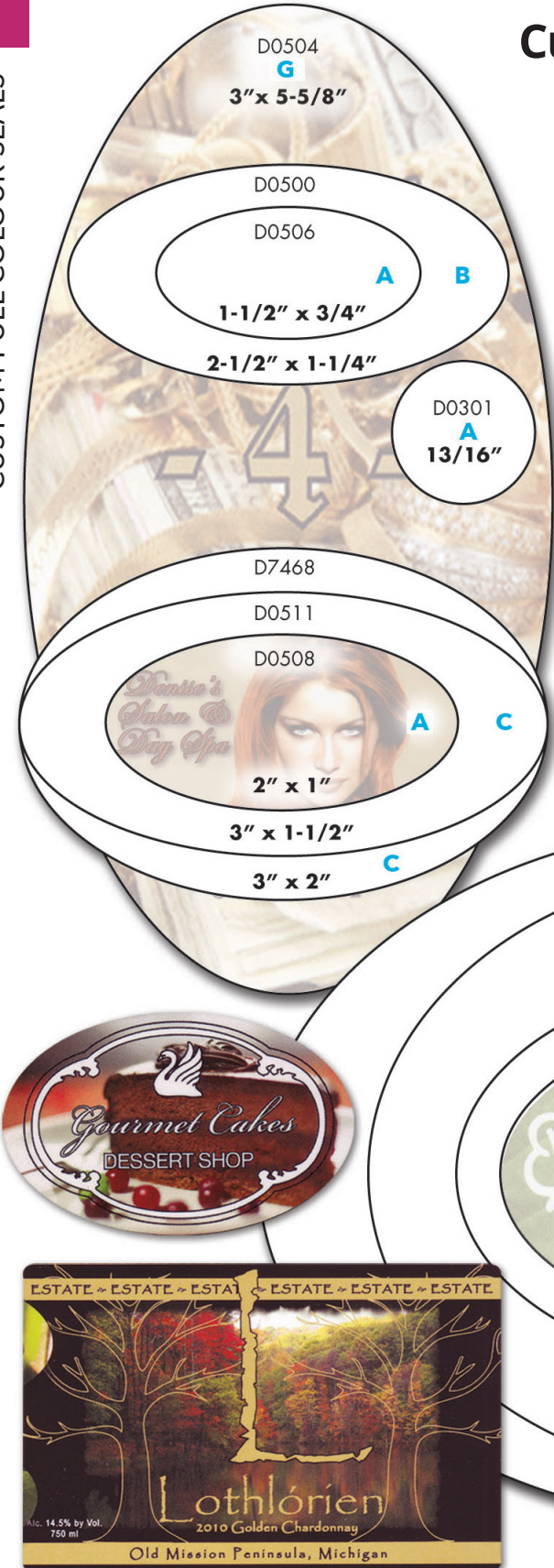

CUSTOM FULL COLOUR SEALS







CUSTOM FULL COLOUR SEALS

# PRINTING INFORMATION

Have your name and logo printed... it's easy!

1. **Select your box or bag style, colour and size.**

2. **Choose the printing method you wish to use.**

-  **A. FOIL PRINTING:** Foil is applied to the bag or box using a combination of heat and pressure on a magnesium print plate to create an elegant appearance. Choice of Metallic or Matte foils. Cost of Foil Printing Print plate per size and colour - \$94.00 (maximum 30 square inches)
-  **B. PAD PRINTING:** Ink is applied to smooth surfaces allowing us to print your logo in places never before possible. Cost of Pad Print plate per size and colour - \$104.50 (maximum 3.75 square inches)
-  **C. FULL COLOUR DIGITAL PRINT:** Utilizing the latest 4-colour process technology, we now offer full colour digital printing graphics on non-laminated paper bags and boxes.
-  **D. FULL COLOUR TRANSFER:** We offer full colour transfer printed graphics on fabric and nylon bags using a heat press process. This full colour transfer print creates an image that allows for vibrant designs. Pricing is the same regardless of the amount of colours used in a design. Have your full colour image applied to your bags for just \$2.45 per bag (minimum 300 bags)
-  **E. INK PRINTING:** Ink is applied to the box or bag using a rubber printing plate. This method is ideal for larger coverage prints and is economically priced. Cost of Ink Printing Plate per size per colour starting at \$137.50. (maximum 25 square inches)
-  **F. SILK SCREEN:** Die fast ink is applied to Fabric Style Bags through a screen. The process allows the ink to permeate into the fabric dimples for optimal coverage. Screen charge of \$65.00 applies with each order.

3. **Choose the Print Colour**

When Foil Printing, select from 41 foil colours in 4 different finishes: Metallic (High Sheen or Matte), flat, gloss or pearlized. For ink printing select from our 9 standard colours for in stock items, or ask about Pantone Matching for Special Order items such as Simply Bags and Fabric Style Bags.

4. **Send us your artwork.**

If you are a new print customer, send us your artwork by e-mail. Artwork must be vector with fonts outlined or high resolution (300 dpi) actual size jpg if vector can not be located.

If you don't have artwork or your artwork needs adjustments, we have a talented design team who can assist you. Contact one of our sales representatives or email us your ideas today. For pricing, see the artwork charges section.

**Acceptable Artwork Formats**

- Vector files (preferred): Adobe Illustrator with .ai, .eps, or .pdf file extension. If the logo was ever professionally made, at a marketing agency, print shop or sign maker, they will have the logo on file. Check with the original graphic designer. If vector cannot be provided, ALL raster formats will be subject to additional art charges as in most cases it will have to be converted to a vector to meet our printers requirements.
- Raster files: (ie. PDF, PSD, TIF, or JPEG) Actual size, high resolution (300dpi or more), is required for all full colour reproduction.
- Please include fonts (.ttf) or convert fonts to outlines when sending ANY Illustrator file, saved as AI, EPS or PDF.

**The following formats are NOT acceptable**

- Publisher (.pub) • CorelDraw (.cdr) • small GIF or BMP internet images • low resolution JPG
- Any Word or spreadsheet documents - '.docx', '.xls', '.wpd', '.od'

If unsure about any format including "what is a vector" please send all inquiries to your inside Customer Service Rep.

## OTHER PRINTING COSTS

**Artwork Charges:** As mentioned above, we have a talented creative team that can work with you to design, create, manipulate or re-size your store logo or name. Artwork service is charged at a rate of \$75.00/hour, min. 1/2 hour.

**Set-up Charges:** Every print job requires a machine to be set-up. A charge will be applied to every order. Foil, Ink, Pad and Digital printing is charged at \$37.00. Silk Screen printing is \$75. Please note: multiple print sizes of the same logo require multiple set-ups.

**Plate Charges:** Plate charges apply one-time only. Each time you require a 'new' print design (i.e. Logo change, Print Size Adjustment etc.) a new plate must be created. Once the plate is made, we will hold it for you in our warehouse and it will be available for all future printing requirements. Plate charges range in cost from \$94.00 for a Foil Printing plate to \$137.50+ for an Ink Printing Plate. (maximum 25 square inches)

## FOIL STAMPING COLOURS

Metallic Options

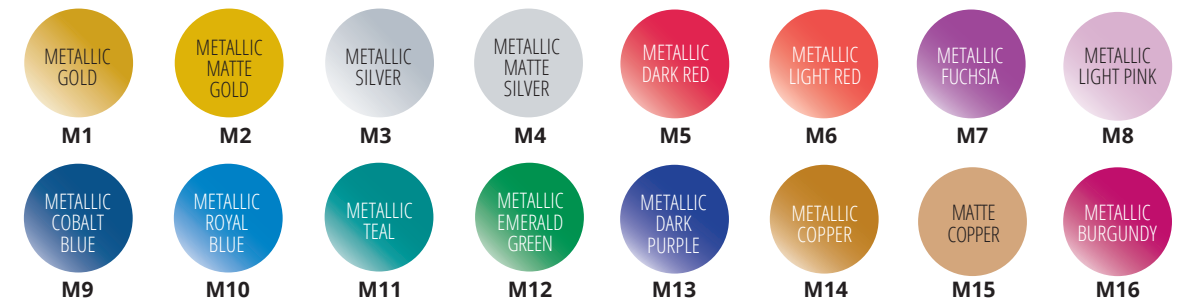

Metallic options feature a high sheen finish unless otherwise indicated as matte finish.

Flat Options



Pearlized Options

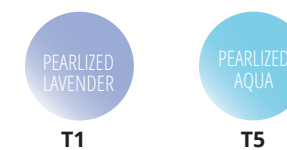

Gloss Options

Gloss Clear - allows the colour of the bag or box to show-through. Gives that tone on tone special highlighted look.



Satine Foil Colours



## INK PRINTING COLOURS

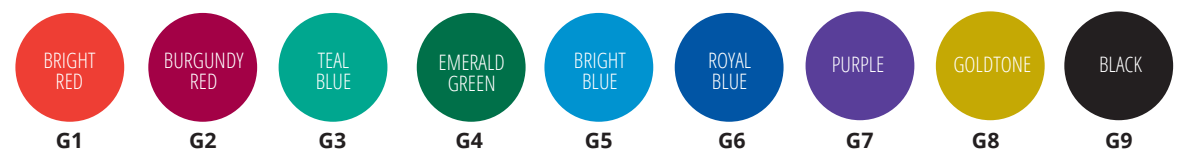

## PAD PRINTING COLOURS

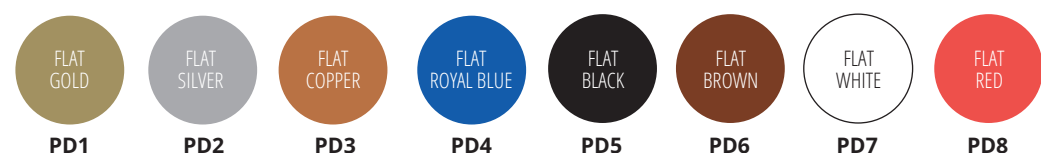

Colours shown are representations only and may not reflect true production colours.

# Want it. Design it. Get it.

## PLACE AN ORDER

Toll Free CANADA: 1.888.486.8437  
Email: [packaging@gunthermele.com](mailto:packaging@gunthermele.com)

Toll Free USA: 1.800.516.0108  
Email: [gmp@gunthermele.com](mailto:gmp@gunthermele.com)

Order on line: [gunthermele.com](http://gunthermele.com)



## EASY PAYMENT OPTIONS

- Online at: [gunthermele.com](http://gunthermele.com) and pay with your credit card
- Over the phone, by: Visa or Mastercard
- Via your bank's online bill payment option by selecting "Gunther Mele" as payee
- Contact head office to set up EFT or ACH

Sign up for paperless billing. See our website for more information.

## TERMS AND CONDITIONS:

- Minimum order \$250.00.
- F.O.B point CANADA: Brantford, Ontario Canada
- F.O.B. point USA: Buffalo, NY USA.
- Net 30 days O.A.C.
- New account payment terms: Visa or MasterCard 50% deposit with order, balance due upon shipping.
- Defective merchandise will be accepted back for credit only if claimed within 15 days of receipt of shipment. Authorization number must be obtained by contacting our customer service department 1.888.486.8437.
- In-transit damages and shortages must be claimed with the freight carrier at time of delivery.
- All lead times are estimates only (from receipt of approved artwork and credit) and are not guaranteed.
- Plate charges where applicable are:
  - Foil Print Dies: \$94.00 per size (maximum 30 square inches)
  - Pad Dies: \$104.50 per size (maximum 3.75 square inches)
  - Ink Plates \$137.50 (maximum 25 square inches)
- **While we strive for accuracy in our catalogue, actual product may be slightly different than pictured.**
- Prices subject to change without notice.

