





OUR VISION

“Helping our customers tell their unique brand story while providing a customer experience like no other.”

– Darrell King, President

Welcome to our new packaging guide – our 165th version since our founding in 1857. We have some exciting developments in the following pages. Most of the changes we have ushered in this year are centered around a more sustainable approach to our business with an emphasis on the materials we use and the reusability of our products. We have begun to view all of our products through this new lens of eco-minded sustainability. We call this our **“Mission Green”**.

Mission Green drives us to use materials that are either from recycled or sustainable sources. It also focuses us on a vastly overlooked practice in sustainability: reusability.



RECYCLED

There are two important terms that classify the source of recycled content. These are: post-consumer waste and post-industrial waste. Post-consumer waste (PCW). Wherever possible, we are using paper and now plastics that are derived, at least partially if not fully, from municipal recycling programs and this term post-consumer implies that it has been recovered after consumer use. Post-industrial waste (PIW). Another key source of recycled material. In this instance, scrap material is diverted from the landfill and recycled into new material to be used in production. Product Examples include: our brand new, Canadian made paper twist shoppers made from paper that is derived from 96% post-consumer waste. Our new “resuede” is a luxurious recycled material that feels like plush suede but is produced using recycled materials to create a luxury look and feel. We feature our resuede material in our Drawer Series box (page 41) and our Eco Series of hinged boxes (page 33)

SUSTAINABLE



FSC® – Forestry Stewardship Council®. In short, this governing body oversees wood and pulp (paper) products derived from responsibly managed forests. This global governing body is an intricate certification process that verifies paper and its sources. In the instances where paper needs to come from new pulp source, we are choosing to use papers that carry the widely recognized FSC designation.

REUSABLE

Jewellery packaging has an inherent keepsake quality. Most people will collect jewellery boxes for storage and sentimental value. We have also been studying consumer behavior and there is demand for an after use of jewellery packaging. Our active lifestyles and thirst for travel dictates the need to store and protect jewelry when it is not being worn. With that, we have introduced our new Nano™ collection of luxurious and practical travel pouches that not only present the jewellery exquisitely but also doubles as ongoing storage and protection for our society who is always on the go.

In nearly every category we have exciting new products that meet our Mission Green criteria. These are just the first steps of our journey toward more sustainable and eco-conscious packaging solutions and we hope you'll join us on this important journey.

NEW PRODUCT



Richmond Series
Satin walnut
See page 11



Glitter Black
Glittery series
See page 27



Tux
Timeless classic
See page 39



Mystique Moonglow
See page 43



Mystique Palladium
See page 43



Eco-Lux Eurototes
See page 56



Alpha
Style meets value
See page 31



Jewellers Velvet Sapphire
New sapphire colour
See page 30



Geo Platinum
New palladium colour
See page 23



Ultrasonic
Heat sealed and durable
See page 68



The Smart Bag
Reclaimed H2O bottles
See page 69



Rigid Collapsible
100% recyclable
See page 74

SPECIAL ORDER

Jewellery Display



SPECIAL ORDER

Jewellery Display

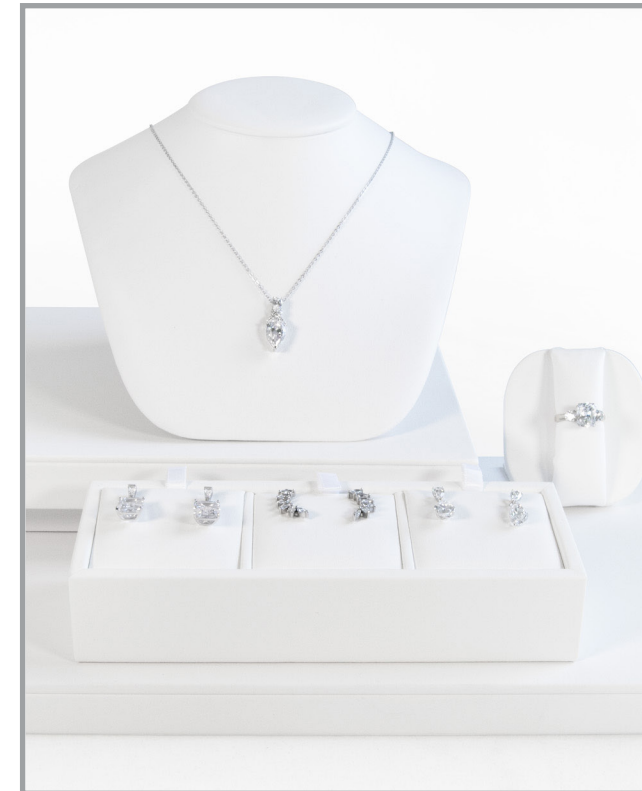

Platforms and Risers

Ring Showcase

Pendant & Earring Stands

Neck Forms & Bracelet Stands

Trays, Counter Pads,
Chain Ramps

Open Stock and Prepacks
Available

**Save 25% when you buy
\$500 or more!**



Tell your brand story
Create your unique identity

Elevate the
shopping experience

Drive more sales

**Complimentary
Display Design**

Financing Programs Available

*Complete set of renderings available with payment of deposit.
Deposits will be deducted from invoice at time of billing.



TABLE OF CONTENTS

Jewellery Packaging

| | | | |
|---|---------|---|-----------|
| Hinged Packaging | 10 - 33 | Horizon Series | 32 |
| New Richmond Wood Series | 11 | EcoBox ECO | 33 |
| Monterey II | 13 | Create Your Own Look Details | 34 - 35 |
| Signature Series | 15 | Jewellery Folders | 36 and 37 |
| Whisper | 17 | Paperboard Jewellery Packaging..... | 38 - 43 |
| Eclipse Series ECO | 19 | New Tux Series ECO | 39 |
| Estate Series | 20 | Deco Series ECO | 40 |
| Roma Series ECO | 21 | ECO The Drawer Box, Vision Box | 41 |
| New Geo Series (new colour) ECO | 23 | Royale Series | 42 |
| Geo Special Order | 25 | New Mystique Series ECO | 43 |
| Palladium Inlay | 26 | Nest Boxes ECO | 44 - 45 |
| New Glitter Black | 27 | Gift Card and Certificate Boxes | 46 - 47 |
| Vantage II ECO | 29 | Pouches | 48 - 49 |
| New Jewellers Velvet (new colour) | 39 | Jewellery Cloths and Cleaners | 50 - 51 |
| New Alpha Series | 31 | Repair Envelopes and Tags | 52 |

Bags

| | | | |
|---|----|--|---------|
| Vantage, Eclipse and Geo Eurototes | 54 | Paper Twist Handle & Damask ECO | 63 |
| Grosgrain Handle Eurototes | 55 | Merchandise Paper Bags ECO | 64 |
| New Eco-Lux Paper Eurototes ECO | 56 | Food Service Kraft Bags ECO | 65 |
| All Paper Eurototes ECO | 57 | New CYOL Jute and Cotton ECO | 66 - 67 |
| CYOL Rope Handle | 58 | New Ultrasonic Weld Reusable ECO | 68 |
| Manhattan Eurototes | 59 | New Smart Bag Reusable | 69 |
| 5th Avenue Eurototes | 60 | Custom Full Colour Reusable | 70 |
| Special Order Tints and Pinstripe | 60 | In Stock Reusable Fabric Shoppers..... | 71 |
| New San Fran Natural Shoppers ECO | 61 | Garment Covers..... | 94 |
| CYOL Simply Paper Shoppers ECO | 62 | | |

Gift Boxes and E-Commerce

| | | | |
|---|----|---|----|
| New Rigid Collapsible ECO | 74 | CYOL E-Com Boxes and Mailers..... | 78 |
| White Folding Gift Boxes | 75 | In Stock E-Com Boxes for Gift & Apparel.... | 79 |
| Apparel Boxes | 75 | In Stock E-Com Boxes for Jewellery | 79 |
| Malibu Magnetic Gift Box | 76 | In Stock and S/O E-Com Mailers | 80 |
| Tuckit® Boxes ECO | 76 | | |

Finishing Touches

| | | | |
|-------------------------------------|---------|---------------------------------------|---------|
| Inspirations Gift Wrap | 82 - 83 | Printed and Unprinted Ribbon | 90 - 93 |
| Special Order Gift wrap | 84- 85 | In Stock Seals - Foil Print | 94 - 95 |
| Special Order Jewellers Rolls | 85 | Custom Seals - Full Colour | 96 - 97 |
| Tissue Paper | 86 - 87 | Print Information & Print Colours.... | 98 - 99 |
| Bows, Cellophane & Dispensers | 88- 89 | | |

JEWELLERY PACKAGING



CREATE YOUR OWN LOOK

IN STOCK Hinged Boxes

JEWELLERY PACKAGING

JEWELLERY PACKAGING



**COORDINATING
EUROTOTES**
See pages 55

New

Outer Box

Richmond ETA: Summer 2024

- Satin walnut
- Ivory brushed suedine pads and top liners
- Packaged in a black 2-piece outer box

| CODE | DESCRIPTION | SIZE (inches) | PRICE /EACH | |
|------------|----------------------|----------------------|-------------|---------|
| | | | 12+ | 144+ |
| A 36521420 | Ring (R1) | 2.375 x 2.375 x 2 | \$12.70 | \$11.43 |
| B 36522420 | Earring (E1) | 2.375 x 2.375 x 2 | \$13.34 | \$12.01 |
| C 36583420 | Utility T-pad (ET14) | 4 x 4 x 2 | \$22.23 | \$20.01 |
| D 36550420 | Pillow (PL1) | 4.375 x 4.375 x 2.75 | \$28.80 | \$25.92 |
| E 36593420 | Bracelet (BL1) | 9.5 x 2.375 x 1.5 | \$25.81 | \$23.23 |
| F 36573420 | Necklace (N1) | 7.5 x 7.5 x 2 | \$40.31 | \$36.28 |

SCAN THIS CODE ON
YOUR PHONE TO ORDER



WOOD SERIES

The possibilities are endless when you choose wooden materials. Endless and timeless, in terms of size, shape, finish and colour. High-end style, this collection features our Monterey series shape with a high gloss white finish, black "reveal" edge and black linea interior. Add a matching custom tote bag to complete the look.



FOIL / PAD PRINT
F: inside liner and packer lid / PP: inside top liner and packer lid

| | |
|------|----------|
| 12+ | 35¢ each |
| 144+ | 32¢ each |
| 504+ | 26¢ each |

Minimum 12 per style.
Please allow 2 - 3 weeks for printed items
from approved art.

CREATE YOUR OWN LOOK

IN STOCK Hinged Boxes

JEWELLERY PACKAGING

JEWELLERY PACKAGING



**COORDINATING
EUROTOTES**
See pages 55

Available Colours



Outer Box
150MC - Black Gloss



Outer Box
320M - Mahogany



**150MCB -
OPTIONAL
BLACK INTERIOR
RING BOX ONLY**

Monterey II

Wood series with modern lines and a gloss finish.

- Soft white leatherette interior
- Packaged in a 2-piece white traditional outer box

| CODE | DESCRIPTION | SIZE (inches) | PRICE/EACH | |
|---------|----------------------|----------------------|------------|---------|
| | | | 12+ | 144+ |
| A 36821 | Ring (R1) | 2.375 x 2.375 x 2 | \$12.38 | \$10.12 |
| B 36822 | Earring (E1) | 2.375 x 2.375 x 2 | \$12.38 | \$10.12 |
| C 36843 | Utility T-pad (ET14) | 4 x 4 x 2 | \$18.69 | \$16.60 |
| D 36850 | Pillow (PL1) | 4.375 x 4.375 x 2.75 | \$24.00 | \$20.18 |
| E 36893 | Bracelet (BL1R) | 9.5 x 2.375 x 1.5 | \$27.88 | \$23.30 |
| F 36813 | Necklace (N1) | 7.5 x 7.5 x 2 | \$40.14 | \$31.02 |

SCAN THIS CODE ON
YOUR PHONE TO ORDER



WOOD SERIES

The possibilities are endless when you choose wooden materials. Endless and timeless, in terms of size, shape, finish and colour. High-end style, this collection features our Monterey series shape with a high gloss white finish, black "reveal" edge and black linea interior. Add a matching custom tote bag to complete the look.

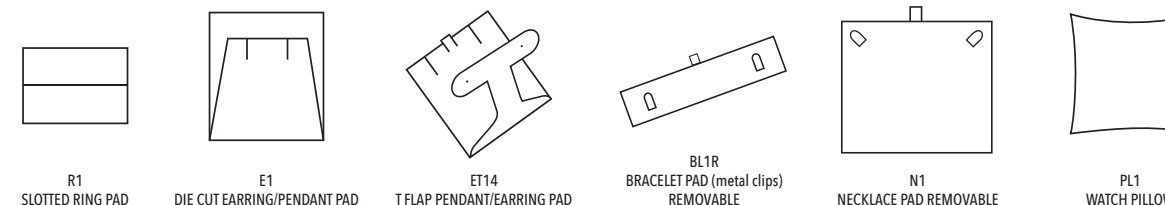

FOIL / PAD PRINT

F: inside liner and packer lid / PP: all 3 locations
12+ 35¢ each
144+ 32¢ each
504+ 26¢ each

Minimum 12 per style.
Please allow 2 - 3 weeks for printed items from approved art.

All print orders subject to set-up charges. Applicable artwork, and plate charges may apply. See page 98.

CREATE YOUR OWN LOOK

IN STOCK Hinged Boxes

JEWELLERY PACKAGING

JEWELLERY PACKAGING



Signature Series

This modernized classic is a must have.

- Plush black velvet hinged boxes accented with suede pads and bengaline trim detail
- Packaged in a coordinating 2-piece outer box

| CODE | DESCRIPTION | SIZE (inches) | PRICE/EACH | |
|-------------|----------------------|--------------------|------------|---------|
| | | | 12+ | 144+ |
| A 36521151 | Ring (R1) | 1.96 x 1.96 x 1.96 | \$9.72 | \$8.56 |
| B 36522151 | Pendant/Earring (E1) | 2.36 x 2.36 x 2.28 | \$12.11 | \$9.87 |
| C 36583151 | Utility (empty) | 3.93 x 3.93 x 2.36 | \$13.26 | \$11.66 |
| C1 69550151 | Pillow (PL1) | fits utility box | \$3.31 | \$2.92 |
| C2 69583151 | Triple Flip Pad (T3) | fits utility box | \$3.31 | \$2.92 |
| D 36573151 | Necklace (N3) | 7 x 7 x 1.77 | \$21.41 | \$18.84 |

SCAN THIS CODE ON
YOUR PHONE TO ORDER

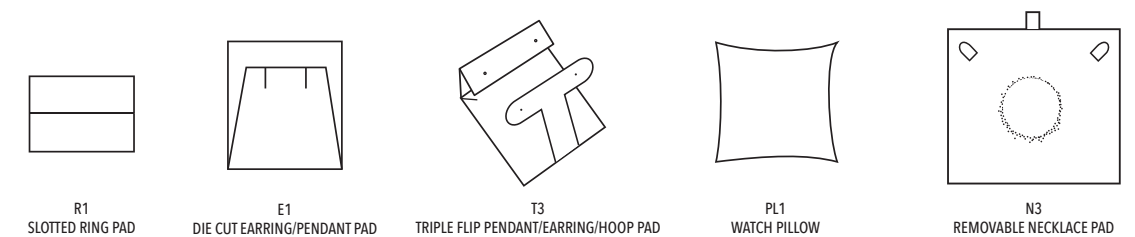

VELVET SERIES

Plush velvet hinged boxes accented with suede pads and bengaline trim detail.

FOIL / PAD PRINT
F / PP: inside liner and packer lid
12+ 35¢ each
144+ 32¢ each
504+ 26¢ each

Minimum 12 per style.
Please allow 2 - 3 weeks for printed items from approved art.

All print orders subject to set-up charges. Applicable artwork, and plate charges may apply. See page 98.

CREATE YOUR OWN LOOK

IN STOCK Hinged Boxes

JEWELLERY PACKAGING

JEWELLERY PACKAGING



**COORDINATING
EUROTOTE**
See page 59

Available Colours



Outer Box
559W - Carbon Black



Outer Box
009W - Moon Glow



Outer Box
289W - Palladium

Whisper

Elegant curves and round corners.

- Monochromatic metallic pinsketch linea fabric
- Packaged in a coordinating 2-piece outer box

| CODE | DESCRIPTION | SIZE (inches) | PRICE/EACH | |
|---------|----------------------|-----------------------|------------|---------|
| | | | 12+ | 144+ |
| A 36821 | Ring (R1) | 2.375 x 2.375 x 2.125 | \$8.68 | \$7.58 |
| B 36822 | Earring (E1) | 2.375 x 2.375 x 2.125 | \$8.68 | \$7.58 |
| C 36823 | Large Ring (R1) | 3.25 x 3.25 x 2.25 | \$11.68 | \$10.11 |
| D 36883 | Utility T-pad (ET14) | 3.25 x 3.25 x 2.25 | \$11.68 | \$10.11 |
| E 36850 | Pillow (PL1) | 4 x 4 x 2.75 | \$15.78 | \$13.74 |
| F 36893 | Bracelet (BL1) | 9.25 x 2.5 x 1.75 | \$15.57 | \$13.60 |
| G 36873 | Necklace (N3) | 6.5 x 8 x 1.75 | \$24.34 | \$19.99 |

SCAN THIS CODE ON
YOUR PHONE TO ORDER



WHISPER SERIES

Our modern luxury box is shown here in a stylish textured gold paper called: Shuttle. Matching texture, the interior and pads create a seamless look.

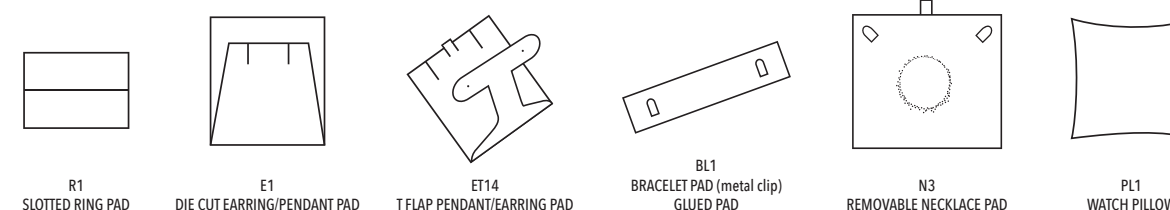

FOIL / PAD PRINT
F: inside liner and packer lid / PP: all 3 locations
12+ 35¢ each
144+ 32¢ each
504+ 26¢ each

Minimum 12 per style.
Please allow 2 - 3 weeks for printed items from approved art.

All print orders subject to set-up charges. Applicable artwork, and plate charges may apply. See page 98.

CREATE YOUR OWN LOOK

IN STOCK Hinged Boxes

JEWELLERY PACKAGING

JEWELLERY PACKAGING



ECLIPSE SERIES

This eclipse collection features an elegant champagne custom embossed covering with an ivory shimmer interior and gold printed logo on the top liner. The custom rope handle tote completes this beautiful collection.



COORDINATING EUROTOTE
See page 56

Available Colours



813 - Linea Blue Celestial



663 - Linea Aubergine



423 - Brown



Eclipse

Classic square corners with a distinctive crescent style front.

- Linea Aubergine and Linea Blue Celestial coverings with Ivory Shimmer satin top liners and pads. Packaged in coordinating full-depth 2-piece outer box
- Rich Brown leatherette covering with Champagne satin top liners and sueded pads. Packaged in white full-depth 2-piece outer box

| CODE | DESCRIPTION | SIZE (inches) | AUBERGINE AND BLUE PRICE/EACH | | BROWN PRICE/EACH | |
|---------|----------------------|-------------------|-------------------------------|---------|------------------|---------|
| | | | 12+ | 144+ | 12+ | 144+ |
| A 36821 | Ring (R1) | 2.5 x 2.5 x 1.75 | \$9.10 | \$7.93 | \$7.59 | \$6.04 |
| B 36822 | Earring/Pendant (E1) | 2.5 x 2.5 x 1.75 | \$9.10 | \$7.93 | \$7.59 | \$6.04 |
| C 36883 | Utility T-pad (ET14) | 3.75 x 4 x 1.75 | \$13.67 | \$12.13 | \$10.00 | \$8.55 |
| D 36893 | Bracelet (BL1R) | 9.25 x 2.5 x 1.75 | \$17.23 | \$15.14 | \$12.76 | \$10.44 |
| E 36873 | Necklace (N2) | 6.5 x 8 x 1.75 | \$28.18 | \$23.21 | \$24.81 | \$20.83 |
| F 36850 | Pillow (PL1) | 3.75 x 4.25 x 3 | \$18.14 | \$15.84 | \$13.55 | \$11.14 |

SCAN THIS CODE ON YOUR PHONE TO ORDER

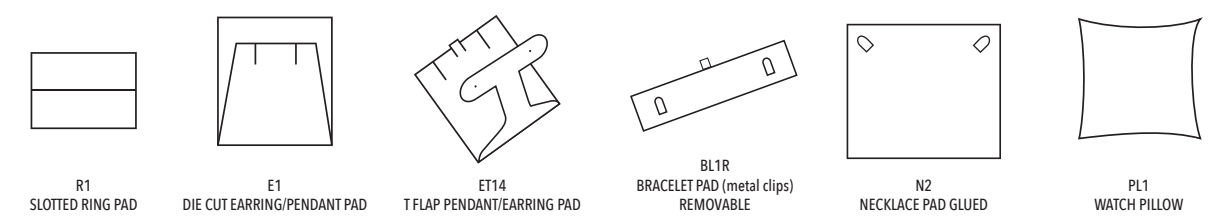

FOIL / PAD PRINT
F: inside liner and packer lid / PP: all 3 locations
12+ 35¢ each
144+ 32¢ each
504+ 26¢ each

Minimum 12 per style.
Please allow 2 - 3 weeks for printed items from approved art.

All print orders subject to set-up charges. Applicable artwork, and plate charges may apply. See page 98.

IN STOCK

Hinged Boxes

JEWELLERY PACKAGING



COORDINATING EUROTOTE
See pages 56



Available Colours



674 - Green

Outer Box

114 - Blue

Outer Box

153 - Black

Outer Box

New

NEW Black
Estimated time of arrival
Summer 2024

SCAN THIS CODE ON YOUR PHONE TO ORDER



Estate

Contemporary style with a touch of tradition.

- White velvet pads and satin top liners
- Packaged in a coordinating 2-piece outer box

| CODE | DESCRIPTION | SIZE (inches) | PRICE/EACH | |
|-------------|----------------------|----------------------|------------|---------|
| | | | 12+ | 144+ |
| A 36021 ___ | Ring (R1) | 2 x 2.25 x 1.875 | \$6.94 | \$5.50 |
| B 36022 ___ | Earring (E1) | 2 x 2.125 x 1.625 | \$6.72 | \$5.36 |
| C 36084 ___ | Utility T-pad (ET14) | 3.5 x 3.5 x 1.5 | \$8.70 | \$7.09 |
| D 36093 ___ | Bracelet (BL1R) | 8.5 x 2.125 x 1 | \$14.95 | \$11.99 |
| E 36073 ___ | Necklace (N3) | 7.125 x 4.375 x 1.25 | \$21.25 | \$17.02 |

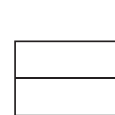

R1
SLOTTED RING PAD

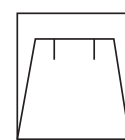

E1
DIE CUT EARRING/PENDANT PAD



ET14
T FLAP PENDANT/EARRING PAD

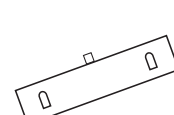

BL1R
BRACELET PAD (metal clips)
REMOVABLE

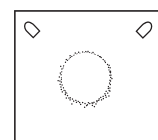

N3
REMOVABLE NECKLACE PAD
GLUED IN



FOIL / PAD PRINT

F: inside liner and packer lid / PP: all 3 locations
12+ 35¢ each
144+ 32¢ each
504+ 26¢ each

Minimum 12 per style.
Please allow 2 - 3 weeks for printed items from approved art.



See page 34.

IN STOCK

Hinged Boxes

JEWELLERY PACKAGING



COORDINATING EUROTOTE
See page 56



50% Recycled Shell

BLACK INTERIOR OPTION 153B - Black on Black

WHITE INTERIOR OPTION 153 - White on Black



Outer Box

Roma

Distinctive round corner styling with sculpted sides.

- Lizard style embossed covering with leatherette interior
- Packaged in a 2-piece coordinating outer box with ¼ depth lids

| CODE | DESCRIPTION | SIZE (inches) | PRICE/EACH | |
|-------------|----------------------|--------------------|------------|---------|
| | | | 12+ | 144+ |
| A 36421 ___ | Ring (R1) | 2.25 x 2.25 x 1.75 | \$6.66 | \$5.40 |
| B 36422 ___ | Earring (E1) | 2.25 x 2.25 x 1.75 | \$6.66 | \$5.40 |
| C 36484 ___ | Utility T-pad (ET14) | 3.75 x 3.75 x 2 | \$8.80 | \$7.51 |
| D 36493 ___ | Bracelet (BL1R) | 9.375 x 2.25 x 1.5 | \$11.63 | \$9.97 |
| E 36477 ___ | Necklace (N3) | 7.5 x 7.5 x 2.125 | \$24.23 | \$20.39 |

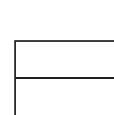

R1
SLOTTED RING PAD

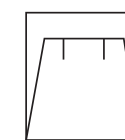

E1
DIE CUT EARRING/PENDANT PAD

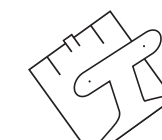

ET14
T FLAP PENDANT/EARRING PAD

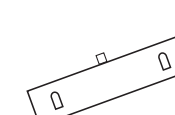

BL1R
BRACELET PAD (metal clips)
REMOVABLE

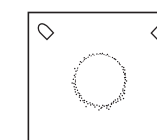

N3
REMOVABLE NECKLACE PAD
GLUED IN



FOIL / PAD PRINT

F: inside liner and packer lid / PP: all 3 locations
12+ 35¢ each
144+ 32¢ each
504+ 26¢ each

Minimum 12 per style.
Please allow 2 - 3 weeks for printed items from approved art.



See page 34.

SCAN THIS CODE ON YOUR PHONE TO ORDER



CREATE YOUR OWN LOOK



GEO SERIES

A series completely unique with added top stitching to the covering and upgrading the fabric to a luxurious grey leatherette. This Geo collection features a debossed logo on the top of the lid. Matching dark interior pads create a seamless look to showcase fine pieces. Packaged in two-tone 3/4 depth outer box with a silver embossed print. This collection is completed with coordinating custom rope handle totes.

IN STOCK

Hinged Boxes



E-Commerce Jewellery Boxes

Deliver the 'in-store' experience to your customer's door.
See page 79 for more information

COORDINATING EUROTOTE
See page 54



Available Colours



873B - Bronze



563P - Purple



153B - Black



083P - Platinum*



415B - Black Packer with Ivory Pouch
456P - Purple Packer with Ivory Pouch
427T - Bronze Packer with Ivory Pouch

Geo

Modern texture in a choice of 4 colour options.

- Ivory brushed leatherette pads and satin top liners
- Packaged in a coordinating 3/4 depth 2-piece outer box

| CODE | DESCRIPTION | SIZE (inches) | PRICE/EACH | |
|-----------|--|-----------------------|------------|---------|
| | | | 12+ | 144+ |
| A 36221 | Ring/Earring (R1) | 2.375 x 2.375 x 2.375 | \$6.05 | \$4.95 |
| B 36283 | T-pad Pendant (ET14) | 3.5 x 4.5 x 1.5 | \$7.20 | \$6.21 |
| C 36293 | Bracelet (BL1R) | 9 x 2.375 x 1.5 | \$9.45 | \$8.03 |
| D 36273 | Necklace (N3) | 7 x 7 x 1.5 | \$15.09 | \$13.05 |
| E 36220 | Proposal Box* (R2) | 2.36 x 2.36 x .94 | \$4.21 | \$3.68 |
| F 36224 | Lighted Ring/Earring* (R1) | 2.36 x 2.36 x 2.36 | \$15.20 | \$13.32 |
| G 09030 | Pouch with Box* | 3 x 4 | \$2.91 | \$2.47 |
| 69221100G | Earring Pad to fit Ring/Earring box (E8) | | \$1.03 | |

* not available in Platinum

SCAN THIS CODE ON YOUR PHONE TO ORDER

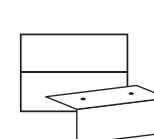

2-PIECE EARRING / R1 SLOTTED RING PAD

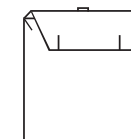

E8 LEVER BACK EARRING PAD

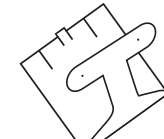

ET14 T FLAP PENDANT/EARRING PAD

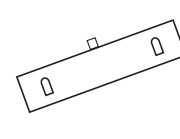

BL1R BRACELET PAD (metal clips) REMOVABLE

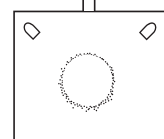

N3 REMOVABLE NECKLACE PAD

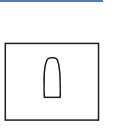

R2 EUROPEAN STYLE CLIP PAD



FOIL / PAD PRINT
F: inside liner and packer lid / PP: all 3 locations
12+ 35¢ each
144+ 32¢ each
504+ 26¢ each

Minimum 12 per style.
Please allow 2 - 3 weeks for printed items from approved art.

All print orders subject to set-up charges. Applicable artwork, and plate charges may apply. See page 98.

SPECIAL ORDER

Geo Series Boxes and Bags

JEWELLERY PACKAGING



Available in 16 colours
in a selection of 4 luxurious
textured papers.



Shown in Celestial Blue

Shown in Moss

Shown in Brick

Contact your representative for assistance
selecting your texture and colour.

SPECIAL ORDER

Geo Series Boxes and Bags

JEWELLERY PACKAGING

16 Colour Options Available



4 Texture Paper Options Available

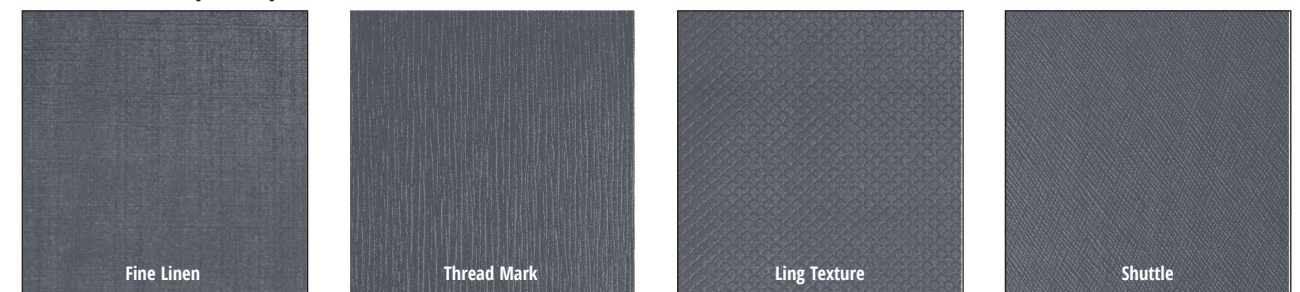

Geo Hinged Packaging

- Ivory brushed leatherette pads and satin top liners
- Packaged in a coordinating ¾ depth 2-piece outer box

| DESCRIPTION | SIZE (inches) | PRICE/EACH |
|----------------------|-----------------------|------------|
| Ring/Earring (R1) | 2.375 x 2.375 x 2.375 | \$5.70 |
| T-pad Pendant (ET14) | 3.5 x 4.5 x 1.5 | \$6.64 |
| Bracelet (BL1R) | 9 x 2.375 x 1.5 | \$7.77 |
| Necklace (N3) | 7 x 7 x 1.5 | \$11.38 |
| Proposal Box (R2) | 2.36 x 2.36 x .94 | \$4.53 |

FOIL PRINT - INCLUDED IN PRICE
Inside Top Liner
Packer Lid

Boxes: Minimum 1500 assorted. (min 100 per box)
Bags: Minimum 1000 each size with purchase of 1500 boxes.
Estimated lead time: 12 - 14 weeks for printed items from approved art.

Geo Eurototes

- 110 gsm uncoated paper with 8mm rope handles
- Foil printed two sides

| SIZE (inches) | PRICE/EACH |
|--------------------|------------|
| 6 x 3.5 x 6 x 3.5 | \$1.47 |
| 9 x 3.5 x 7 x 3.5 | \$1.76 |
| 10.5 x 5 x 8.5 x 5 | \$2.16 |

FOIL PRINT
INCLUDED IN PRICE

Bags Only: Minimum 3000 each size.
Estimated lead time: 12 - 14 weeks for printed items from approved art.

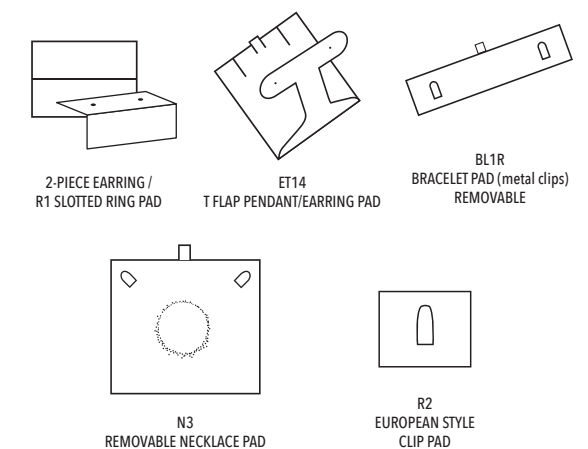

Our Top Selling Collection Just Got Even Better!

Printing included for
any of the items in this program.

Choice of Matte or Metallic Foil Print:
Gold, Silver, Copper or Black.

All print orders subject to set-up charges. Applicable artwork, and plate charges may apply. See page 98.

IN STOCK

Hinged Boxes

JEWELLERY PACKAGING



COORDINATING EUROTOTE
See page 55

Palladium Inlay

Stylish contemporary series.

- Palladium grey brushed exterior
- Cream pads and top liner with matching exterior edge
- Packaged in a coordinating 2-piece outer box

| CODE | DESCRIPTION | SIZE (inches) | PRICE/EACH | |
|-------------|----------------------|--------------------|------------|---------|
| | | | 12+ | 144+ |
| A 36221283P | Ring (R1) | 2.25 x 2 x 1.75 | \$6.32 | \$5.19 |
| B 36222283P | Earring (E1) | 2.25 x 2 x 1.75 | \$6.32 | \$5.19 |
| C 36283283P | Utility T-pad (ET14) | 3.18 x 4.17 x 1.41 | \$8.91 | \$7.57 |
| D 36293283P | Bracelet (BL1) | 8.6 x 2.16 x 1 | \$10.24 | \$8.58 |
| E 36273283P | Necklace (N2) | 6.25 x 4.4 x 1.41 | \$12.23 | \$10.31 |

SCAN THIS CODE ON YOUR PHONE TO ORDER



FOIL / PAD PRINT
F: inside liner and packer lid / PP: all 3 locations
12+ 35¢ each
144+ 32¢ each
504+ 26¢ each

Minimum 12 per style.
Please allow 2 - 3 weeks for printed items from approved art.



IN STOCK

Hinged Boxes

JEWELLERY PACKAGING



COORDINATING EUROTOTE
See page 57



Glitter Black

Sparkle and shine with this great glittering series.

- Black faux suede pads and satin top liners
- Packaged in individual black sleeves

| CODE | DESCRIPTION | SIZE (inches) | PRICE/EACH | |
|--------------|----------------------|--------------------|------------|--------|
| | | | 12+ | 144+ |
| A 36221183GB | Ring (R1) | 1.75 x 2 x 1.5 | \$2.77 | \$2.44 |
| B 36222183GB | Earring (E1) | 1.75 x 2 x 1.5 | \$2.77 | \$2.44 |
| C 36284183GB | Utility T-pad (ET14) | 3.5 x 3.5 x 1.25 | \$4.67 | \$4.12 |
| D 36293183GB | Bracelet (BL1) | 8.75 x 2.125 x 1 | \$6.02 | \$5.29 |
| E 36273183GB | Necklace (N2) | 6.25 x 4.25 x 1.25 | \$7.67 | \$6.74 |

SCAN THIS CODE ON YOUR PHONE TO ORDER



FOIL / PAD PRINT
F: inside liner / PP: inside top liner and box lid
12+ 35¢ each
144+ 32¢ each
504+ 26¢ each

Minimum 12 per style.
Please allow 2 - 3 weeks for printed items from approved art.



CREATE YOUR OWN LOOK

IN STOCK Hinged Boxes

JEWELLERY PACKAGING

JEWELLERY PACKAGING



VANTAGE SERIES

6 pieces - 2 boxes + 4 inserts + 9 presentations. A streamlined and customized assortment.



COORDINATING EUROTOTE
See below and on page 54

Available Colours



Vantage II

Elegant gold or silver in a linen embossed pattern.

- White satin top liners and leatherette bottom pads
- Packaged in a coordinating 3/4 depth lid 2-piece outer box

| CODE | DESCRIPTION | SIZE (inches) | PRICE/EACH | |
|---------|----------------------|----------------------|------------|---------|
| | | | 12+ | 144+ |
| A 36221 | Ring/Earring (R1/E8) | 2 x 2 x 1.625 | \$5.15 | \$4.37 |
| B 36232 | T-Pad Pendant (ET14) | 2.64 x 2.72 x 2.165 | \$6.18 | \$5.25 |
| C 36284 | Utility T-pad (ET14) | 3.5 x 3.5 x 2 | \$7.50 | \$6.37 |
| D 36293 | Bracelet (BL1) | 8.625 x 2.125 x 1.25 | \$10.23 | \$8.69 |
| E 36273 | Necklace (N2) | 6.25 x 4.5 x 1.5 | \$12.85 | \$10.91 |

FOIL / PAD PRINT
F: inside liner and packer lid / PP: all 3 locations
12+ 35¢ each
144+ 32¢ each
504+ 26¢ each

Minimum 12 per style.
Please allow 2 - 3 weeks for printed items from approved art.

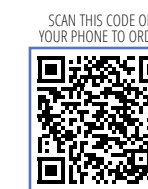
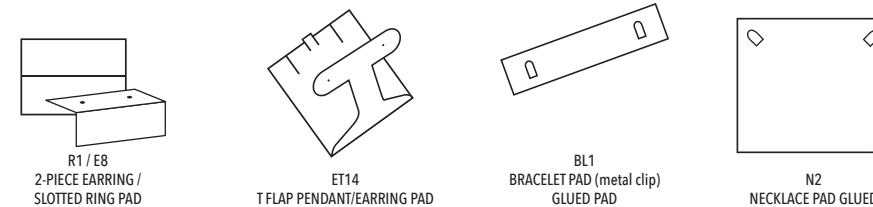

Coordinating Eurototes

- 150 gsm uncoated paper with 8mm paper cord handles
- Minimum 100 per colour

| CODE | SIZE (inches) | PRICE/EACH | | |
|--------|--------------------|------------|--------|--------|
| | | 100+ | 500+ | 1000+ |
| 230606 | 6 x 3.5 x 6 x 3.5 | \$1.28 | \$1.17 | \$1.01 |
| 231008 | 10.5 x 5 x 8.5 x 5 | \$1.63 | \$1.46 | \$1.25 |

07V - Gold



08V - Silver



FOIL PRINT
100+ 35¢ each
1000+ 32¢ each
2500+ 26¢ each

Estimated lead time: 2 - 3 weeks for printed items from approved art.

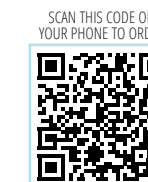

All print orders subject to set-up charges. Applicable artwork, and plate charges may apply. See page 98.

IN STOCK

Hinged Boxes

COORDINATING EUROTOTE
See page 56



Available Colours



Jewellers Velvet

Lasting traditions.

- Satin top liners
- Packaged in a white 2-piece outer box

| CODE | DESCRIPTION | SIZE (inches) | 12+ | 144+ |
|---------|----------------------|-------------------|---------|--------|
| A 36121 | Ring (R1) | 2 x 2.125 x 1.5 | \$3.69 | \$2.87 |
| B 36141 | Double Ring (R1) | 2.5 x 2 x 1.5 | \$4.32 | \$3.35 |
| C 36122 | Earring (E2) | 2 x 2.125 x 1.5 | \$3.69 | \$2.87 |
| D 36132 | Utility T-pad (ET14) | 2.5 x 2.5 x 1.25 | \$4.45 | \$3.48 |
| E 36163 | Pendant (E1) | 2.25 x 3 x 1.125 | \$4.96 | \$3.73 |
| F 36183 | Utility (EP4) | 3.5 x 3.375 x 1.5 | \$6.84 | \$5.37 |
| G 36193 | Bracelet (BL1) | 8 x 2 x 1.25 | \$7.58 | \$5.88 |
| H 36173 | Necklace (N2) | 7 x 4.25 x 1.5 | \$11.58 | \$9.16 |

SCAN THIS CODE ON YOUR PHONE TO ORDER

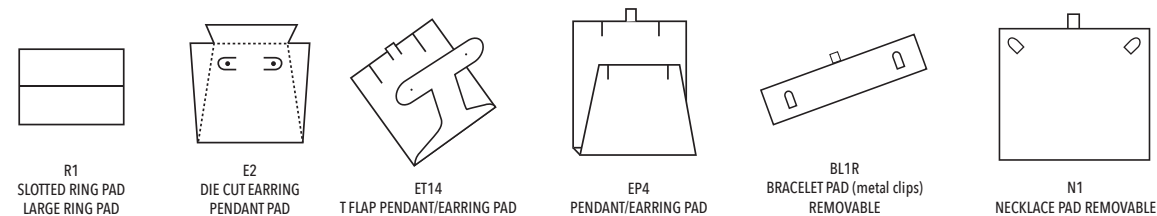

FOIL / PAD PRINT

F: inside liner and packer lid / PP: inside top liner and packer lid
12+ 35¢ each
144+ 32¢ each
504+ 26¢ each

Minimum 12 per style.
Please allow 2 - 3 weeks for printed items from approved art.



IN STOCK

Hinged Box

COORDINATING EUROTOTE
See page 54



Alpha

Style meets value.

- Soft white leatherette and top liners
- Packaged in a white 2-piece outer box

| CODE | DESCRIPTION | SIZE (inches) | PRICE / EACH | |
|------------|----------------------|-----------------------|--------------|--------|
| | | | 12+ | 144+ |
| A 36621002 | Ring (R1) | 1.875 x 2.125 x 1.375 | \$2.96 | \$2.66 |
| B 36641002 | Double Ring (R1) | 2.375 x 2 x 1.5 | \$3.28 | \$2.95 |
| C 36622002 | Earring (E2) | 1.875 x 2.125 x 1.375 | \$2.83 | \$2.55 |
| D 36663002 | Pendant (EP4) | 2.25 x 3 x 1.125 | \$3.92 | \$3.53 |
| E 36632002 | T-pad Pendant (ET14) | 2.5 x 2.5 x 1.25 | \$3.43 | \$3.09 |
| F 36683002 | Utility (EP4) | 3.875 x 3.25 x 1.375 | \$5.44 | \$4.89 |
| G 36693002 | Bracelet (BL1) | 8 x 2.125 x 1 | \$5.85 | \$5.27 |
| H 36673002 | Necklace (N1) | 7 x 4.25 x 1.375 | \$8.60 | \$7.74 |

SCAN THIS CODE ON YOUR PHONE TO ORDER

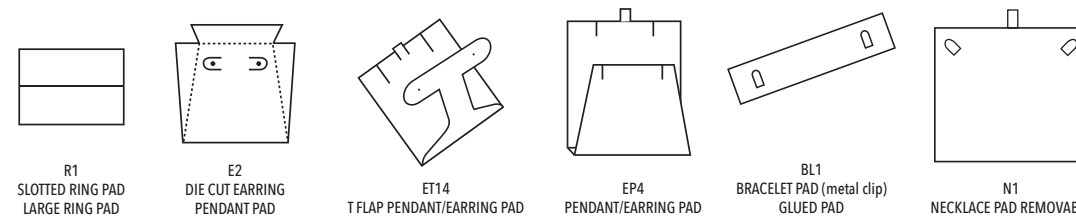

FOIL / PAD PRINT

F: inside liner and packer lid / PP: inside top liner and packer lid
12+ 35¢ each
144+ 32¢ each
504+ 26¢ each

Minimum 12 per style.
Please allow 2 - 3 weeks for printed items from approved art.



IN STOCK

Hinged Boxes

COORDINATING EUROTOTE
See page 56



E-Commerce Jewellery Boxes

Deliver the 'in-store' experience to your customer's door.
See page 79 for more information



Available Colours



003 - White

663 - Burgundy

153 - Black

Horizon

The gold standard in a classic white, burgundy and black.

- White velour pads and satin top liners
- Packaged in a white traditional 2-piece outer box

| CODE | DESCRIPTION | SIZE (inches) | 12+ | 144+ |
|-------------|--------------------------|---------------------|---------|--------|
| A 36621 | Ring (R1) | 2.125 x 2 x 2 | \$3.92 | \$3.06 |
| B 36622 | Earring (E1) | 2.125 x 2 x 2 | \$3.92 | \$3.06 |
| C 36641 | Double Ring (R1) | 3 x 2 x 2 | \$4.48 | \$3.65 |
| D 36684 | Utility T-pad (ET14) | 3.5 x 3.5 x 1.5 | \$5.65 | \$4.52 |
| E 36632 | T-Pad Pendant (ET14) | 2.75 x 2.75 x 1.375 | \$5.59 | \$4.38 |
| F 36693 | Bracelet (BL1) | 8.25 x 2.125 x 1.25 | \$7.38 | \$6.00 |
| G 36673 | Necklace (N2) | 6.25 x 5 x 1.5 | \$11.58 | \$9.09 |
| H 36650 | Bangle (R1) | 1 x 3.75 x 3.125 | \$4.82 | \$4.14 |
| I 69621000B | Bead Pad for earring box | | \$0.68 | \$0.56 |

BLACK PADS AVAILABLE (3 SIZES)

| | | | | | |
|-------------|--------------------------|-------------|-----------|--------|--------|
| J 36621153B | Single Ring Pad (black) | 2.125 X 2 | box w/pad | \$3.92 | \$3.06 |
| 69622153B | Stud Earring Pad (black) | 2.125 x 2 | pad only | \$0.34 | \$0.34 |
| 69633153B | Pend/Earring Pad (black) | 2.75 x 2.75 | pad only | \$1.09 | \$1.09 |



Bead Pad

- pad fits stud earring box
- ribbon threads through bead
- ribbon wraps to back and is held by clip



FOIL / PAD PRINT
F: inside liner and packer lid / PP: all 3 locations
12+ 35¢ each
144+ 32¢ each
504+ 26¢ each

Minimum 12 per style.
Please allow 2 - 3 weeks for printed items from approved art.

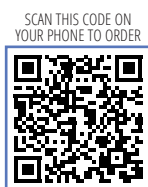

IN STOCK

Hinged Box

COORDINATING ALL PAPER EUROTOTE
See page 57



Outer Sleeve

EcoBox

Modern look inside and out.

- Gunther Mele Mission Green product
- Made with recycled paper exterior
- Made with 50% recycled material plastic shell
- Resuede interior material (49% recycled)



50% Recycled Shell

| CODE | DESCRIPTION | SIZE (inches) | 12+ | 144+ |
|------------|------------------------------|--------------------|---------|---------|
| A 36121000 | Ring/Earring (R1) | 2 x 2 x 1.5 | \$4.93 | \$4.18 |
| B 36163000 | T-Pad Pendant/Earring (ET14) | 3.75 x 3.75 x 1.33 | \$7.92 | \$6.73 |
| C 36193000 | Bracelet (BL1) | 8.5 x 2 x .91 | \$6.97 | \$5.92 |
| D 36173000 | Necklace (N3) | 7 x 5 x 1.10 | \$12.65 | \$10.76 |

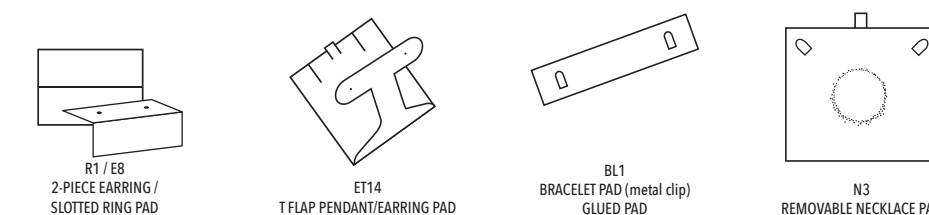

FOIL / PAD PRINT
F: inside liner / PP: top lid
12+ 35¢ each
144+ 32¢ each
504+ 26¢ each

Minimum 12 per style.
Please allow 2 - 3 weeks for printed items from approved art.

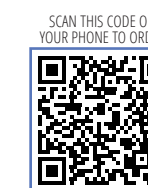

CREATE YOUR OWN LOOK

TELL YOUR BRAND STORY CREATE YOUR UNIQUE IDENTITY



Create Your Own Look
in 7 Easy Steps

Speak to your
sales representative
for a consultation.

Looking for 100% custom design? Design your very own jewellery packaging.

STEP 1:

Choose your box style.
We have access to endless design and looks. You dream it, we can create it.
Choose from wood, plastic, MDF and paperboard shells.
Select hinged or 2-piece.
MOQ:
Plastic or Metal 2,500
Wood 1,000
Paperboard 5,000

STEP 2:

Choose your covering and colour.
Leatherette, velvet, paper.
Design your texture—hundreds to choose from, or create your own. Brushed leatherette, embossed papers, smooth, textured, Select from our colour books, or use Pantone to specify your exact colours.

STEP 3:

Specify the interior.
Select pad colour and material for inside lid.
Leatherette, brushed leatherette, flocked, velvet, velour.
Decide on the top interior material—leatherette, brushed leatherette, satin, flocked, velvet.
Select colour—white, black, ivory are most common.
Option—create a reveal with contrasting colour.

STEP 4:

Design your packer.
2- piece box or sleeve.
Often you can use the same material or create a coordinating colour.
Option -- add die cuts at bottom for ribbon, and/or reveal for contrasting colour.



STEP 5:

Design logo placement.
Areas to consider:
Inside box lid (Top Satin)
Packer Lid (can be centered, or placed at lower corner if using ribbon)
Top Lid



STEP 6:

Select your pad designs. (See page 35)

STEP 7:

Email your artwork.
Artwork ultimately needs to be in Vector file format. Your graphic designers should be able to assist you. Gunther Mele is also available to provide artwork assistance and full service design, cost is \$75/hour, min half hour charge.

CYOL has 16-20 weeks lead time. (Time frames based on signed approved artwork, quote and deposit).
Printing and pre-production samples included at no extra charge.

Please note:

Logos with intricate lines and details (such as diamonds), often will not translate in small print areas, such as top satins. Designs with text and simple outlines work best for inside of ring boxes, etc. Reps and our designers will advise you when artwork should be modified to produce best results.

To ensure accuracy and best quality, signatures are required on all artwork documents and quote documents where noted. Production will not commence until all artwork, quotes and deposits are finalized and signed off. Your rep is available to work with you to ensure all documentation is completed to prevent delays. Please ensure your email access is update date.

Complete your look!

Bags, Tissue, Pouches, Ribbon, Displays, Necklace folders, and more!

Select from our in stock or create your own. Gunther Mele is your one stop for all your needs.

Our sales representative can help you design all your packaging and displays to tell your unique brand story.

CREATE YOUR OWN LOOK

RING PADS

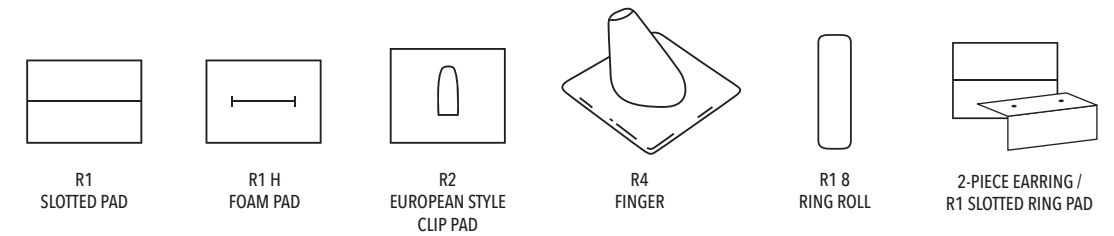

EARRING PADS

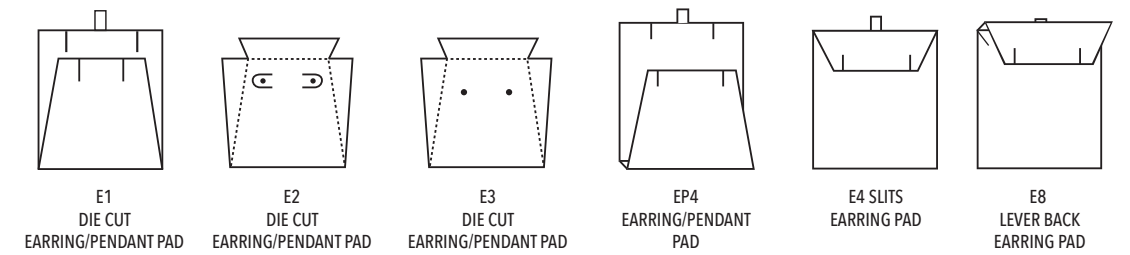

EARRING/PENDANT PADS

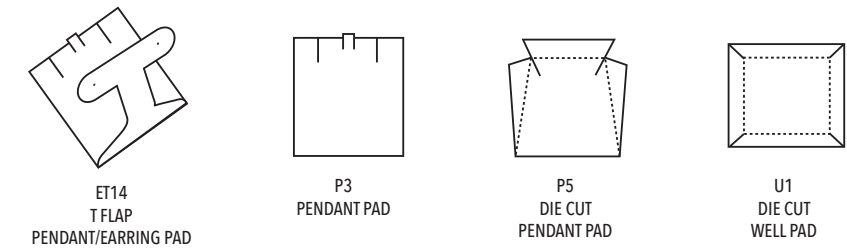

BRACELET AND WATCH PADS

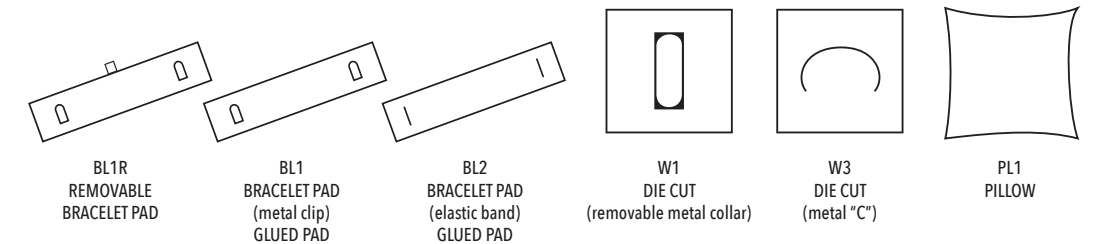

NECKLACE PADS

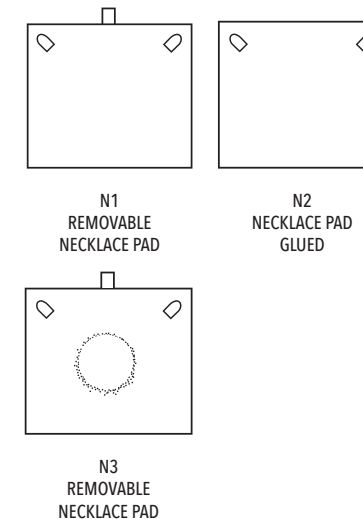

TRIPLE FLIP PADS

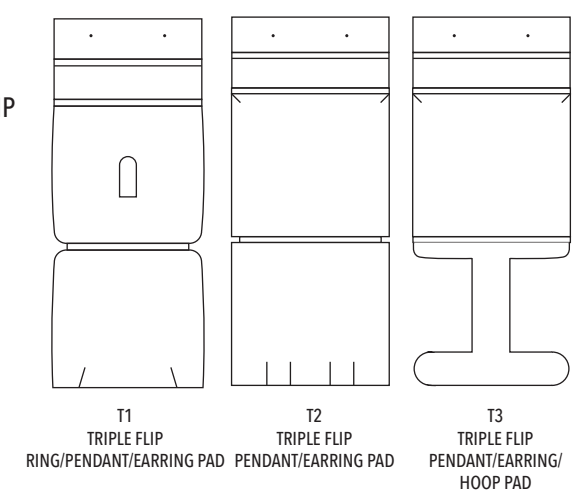

IN STOCK

Jewellery Packaging



Nano Clutch

Perfect for gifting and on the go, this collection is going places!

- Linea envelope, and pad
- Packaged in a 2-piece matching outer box

| CODE | DESCRIPTION | SIZE (inches) | PRICE/EACH | |
|-------|-----------------|---------------|------------|--------|
| | | | 12+ | 144+ |
| 09121 | Ring (R1) | 2.55 X 2.55 | \$2.49 | \$2.30 |
| 09163 | Pendant (P3) | 4 X 4 | \$3.04 | \$2.80 |
| 09193 | Bracelet (BL1R) | 9.625 X 3.125 | \$4.19 | \$3.85 |
| 09173 | Necklace (N1) | 6.625 X 6.625 | \$5.72 | \$5.27 |

Available Colours



151C - Carbon Black

001M - Diamond White

SCAN THIS CODE ON YOUR PHONE TO ORDER

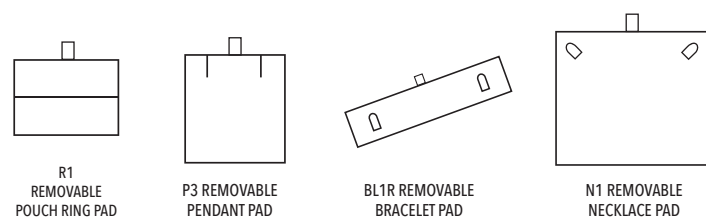

FOIL / PAD PRINT

F: outside flap and packer / PP: outside flap and packer
 12+ 35c each
 144+ 32c each
 504+ 26c each

Minimum 12 per style.
 Please allow 2 - 3 weeks for printed items from approved art.



See page 34.

All print orders subject to set-up charges. Applicable artwork, and plate charges may apply. See page 98.

IN STOCK

Jewellery Folders



Passport Jewellery Folders

Designed with stylish envelope closure, snaps tight to keep jewels secure.

- Linea exteriors, satin interior
- Packaged in a 2-Piece white outer box
- Two colours soft white and black
- Case pack of 12

SCAN THIS CODE ON YOUR PHONE TO ORDER



| CODE | DESCRIPTION | SIZE (inches) | 12+ | 144+ |
|--------|----------------|---------------|--------|--------|
| 367950 | Bracelet | 8.25 x 1.75 | \$5.90 | \$5.02 |
| 367900 | Necklace/Pearl | 6 x 8 | \$9.83 | \$8.40 |



FOIL / PAD PRINT

Bracelet: F and PP: inside bottom flap and packer lid
 Necklace: PP: top flap / F and PP: inside flap and packer lid
 12+ 35c each
 144+ 32c each
 504+ 26c each

Estimated lead time: 2 - 3 weeks for printed items from approved art.



Global Jewellery Folders

Wide gusset folder for larger pieces.

- Bronze and pearl linea
- Packaged in a 2-Piece matching outer box
- Black faux suede
- Case pack of 12
- Satin interior and magnetic closure

| CODE | SIZE (in.) | PRICE /EACH | |
|-------|------------|-------------|---------|
| | | 12+ | 144+ |
| 36790 | 5.5 x 7.5 | \$12.48 | \$10.47 |



FOIL / PAD PRINT

PP: top flap / F and PP: inside flap and packer lid
 12+ 35c each
 144+ 32c each
 504+ 26c each

Estimated lead time: 2 - 3 weeks for printed items from approved art.

SCAN THIS CODE ON YOUR PHONE TO ORDER



Hoop Earring Folder

Black ultrasuede folder with top stitch finish and black interior. Holds hoop earrings up to 2.75" in diameter.

- Packaged in a white 2-Piece outer box
- Case pack of 12

| CODE | SIZE (in.) | PRICE /EACH | |
|----------|------------|-------------|--------|
| | | 12+ | 144+ |
| 36791015 | 4.5 x 4.5 | \$4.60 | \$3.96 |



FOIL / PAD PRINT

F: packer lid / PP: packer lid
 12+ 35c each
 144+ 32c each
 504+ 26c each

Estimated lead time: 2 - 3 weeks for printed items from approved art.

SCAN THIS CODE ON YOUR PHONE TO ORDER



All print orders subject to set-up charges. Applicable artwork, and plate charges may apply. See page 98.

CREATE YOUR OWN LOOK

IN STOCK 2-Piece Boxes

JEWELLERY PACKAGING

JEWELLERY PACKAGING



COORDINATING
ALL PAPER EUROTOTE
See page 57

New

Tux

A timeless classic.

- Black 2-piece boxes with white flocked foam pads
- Crisp white grosgrain ribbon
- Packaged in individual white sleeves

| CODE | DESCRIPTION | SIZE (inches) | CASE PACK | PRICE/EACH | |
|------------|-----------------|----------------|-----------|------------|--------|
| | | | | 25+ | 500+ |
| A 31521153 | Ring (R1) | 2.5 x 2.25 x 2 | 50 | \$2.39 | \$2.11 |
| B 31583153 | Utility (EP4) | 3 x 3 x 2 | 50 | \$3.31 | \$2.91 |
| C 31593153 | Bracelet (BLR1) | 9 x 2.25 x 1.5 | 50 | \$4.55 | \$4.00 |
| D 31573153 | Necklace (N1) | 6.25 x 8 x 2 | 25 | \$5.95 | \$5.24 |

SCAN THIS CODE ON
YOUR PHONE TO ORDER

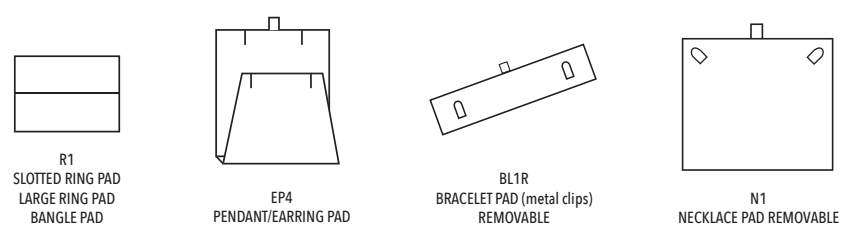

FOIL / PAD PRINT
F: inside and top lid / PP: inside and top lid
50/100+ 35¢ each
1000+ 32¢ each
2500+ 26¢ each

Minimum one case pack.
Please allow 2 - 3 weeks for printed items from approved art.

All print orders subject to set-up charges. Applicable artwork, and plate charges may apply. See page 98.

All print orders subject to set-up charges. Applicable artwork, and plate charges may apply. See page 98.

IN STOCK

Paperboard Hinged

JEWELLERY PACKAGING



COORDINATING EUROTOTE
See page 56



Recycled Paperboard



Pads are removable and reversible. Choose white flock or black flock.



Deco

Iconic black and white.

- Paperboard construction, covered in smooth laminate paper
- Flocked reversible black and white foam pads
- Packaged in individual white sleeves

| CODE | DESCRIPTION | SIZE (inches) | CASE PACK | PRICE/EACH | |
|-------------|--------------------|-------------------|-----------|------------|--------|
| | | | | 50+ | 500+ |
| A 31621153D | Ring (R1H) | 2 x 2 x 1 | 50 | \$1.68 | \$1.42 |
| B 31622153D | Earring (P3) | 2 x 2 x 1 | 50 | \$1.68 | \$1.42 |
| C 31632153D | Large Earring (P3) | 2.5 x 2.5 x 1.75 | 50 | \$2.18 | \$1.85 |
| D 31684153D | Utility (P2) | 3.75 x 3.75 x 1.5 | 50 | \$3.46 | \$2.94 |
| E 31693153D | Bracelet (BL1) | 9 x 2 x 1.125 | 50 | \$3.63 | \$3.08 |
| F 31673153D | Necklace (N2) | 6.5 x 8 x 2 | 50 | \$7.80 | \$6.63 |

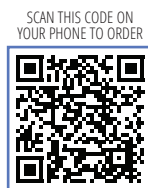

SCAN THIS CODE ON YOUR PHONE TO ORDER

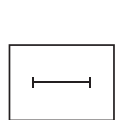

R1 H
REVERSABLE FOAM PAD

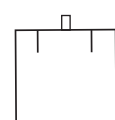

P3
REVERSABLE TOP SLIT
PENDANT/EARRING PAD

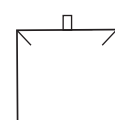

P2
REVERSABLE
CORNER CUT PENDANT PAD

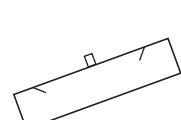

BL1
REVERSABLE
TOP SLIT BRACELET PAD

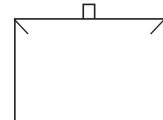

N2
REVERSABLE
CORNER CUT NECKLACE PAD



FOIL / PAD PRINT

F: inside and top lid / PP: inside and top lid
50+ 35¢ each
500+ 32¢ each
2500+ 26¢ each

Minimum one case pack.
Please allow 2 - 3 weeks for printed items from approved art.



See page 34.

IN STOCK

Specialty

JEWELLERY PACKAGING



The Drawer Box

Eco-friendly, on trend series.

- Removable resuede recycled pads
- Fixed ring pad with foam
- Made with 100% recycled paperboard
- Coordinates with the Nano Pouch for a stunning reveal (earring & pendant)



Recycled Paperboard



See page 34.

| CODE | DESCRIPTION | SIZE (inches) | CASE PACK | PRICE/EACH | |
|----------|-----------------|--------------------|-----------|------------|--------|
| | | | | 50+ | 500+ |
| 31050603 | Ring (R1) | 2.24 x 2.36 x 1.98 | 50 | \$2.67 | \$2.13 |
| 31070703 | Earring Utility | 2.75 x 2.83 x 1.57 | 50 | \$3.07 | \$2.46 |
| 31101003 | Pendant Utility | 3.93 x 4 x 1.57 | 50 | \$4.01 | \$3.21 |

SCAN THIS CODE ON YOUR PHONE TO ORDER



PAD PRINT

PP: box top
50+ 35¢ each
500+ 32¢ each
2500+ 26¢ each

Minimum one case pack.
Please allow 2 - 3 weeks for printed items from approved art.

Vision Box

Unique transparent 3D window box with coordinating display stand.

- Transparent puncture resistant elastic film
- Conforms to hold any jewellery piece
- Coordinating display base (extra)

| CODE | DESCRIPTION | SIZE (inches) | PRICE/EACH | |
|----------|------------------|-------------------|------------|--------|
| | | | 12+ | 144+ |
| 36301103 | Small | 2.68 x 2.68 x .75 | \$1.19 | \$0.95 |
| 36302103 | Medium | 3.5 x 3.5 x .75 | \$1.59 | \$1.27 |
| 36303103 | Large | 4.25 x 4.25 x .75 | \$1.99 | \$1.59 |
| 69300103 | Base (pkg of 12) | 2.25 x 2.25 x .62 | \$0.99 | \$0.73 |

SCAN THIS CODE ON YOUR PHONE TO ORDER



PAD PRINT

PP: side of lid - text only - limited space
12+ 35¢ each
144+ 32¢ each
504+ 26¢ each

Minimum 12 per style.
Please allow 2 - 3 weeks for printed items from approved art.

All print orders subject to set-up charges. Applicable artwork, and plate charges may apply. See page 98.

IN STOCK

Paperboard Hinged

IN STOCK

2-Piece Boxes

JEWELLERY PACKAGING

JEWELLERY PACKAGING



COORDINATING EUROTOTE
See pages 56

Royale

Hinged, white paperboard boxes covered in finely ribbed paper with gold accent lines.

- Texture paper wrapped hinged boxes with white flocked foam pads
- Match with Rope Handle Eurototes
- Packaged in individual white sleeves

| CODE | DESCRIPTION | SIZE (inches) | CASE PACK | PRICE/EACH | |
|----------|----------------------|-------------------|-----------|------------|--------|
| | | | | 50+ | 1000+ |
| 31545003 | Ring/Earring (R1H) | 2.5 x 2 x 1.5 | 100 | \$1.47 | \$1.34 |
| 31533003 | Pendant/Earring (P2) | 2.75 x 2.75 x 1 | 100 | \$1.76 | \$1.55 |
| 31560003 | Utility (P3) | 3.5 x 3.5 x 1 | 50 | \$2.14 | \$1.88 |
| 31580003 | Bracelet (BL2) | 8.125 x 2.125 x 1 | 50 | \$2.76 | \$2.48 |
| 31575003 | Necklace (N1) | 6.5 x 4.5 x 1 | 50 | \$4.25 | \$3.69 |

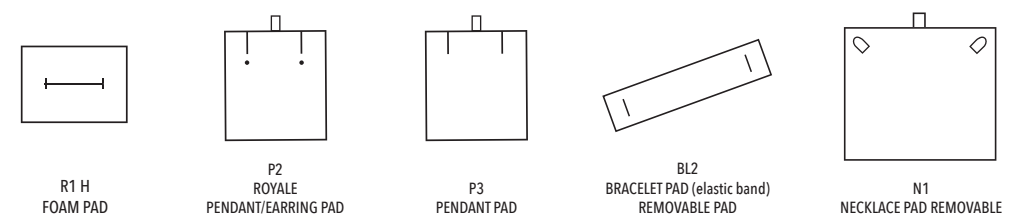

FOIL / PAD PRINT
F: inside and top lid / PP: inside and top lid
50/100+ 35c each
1000+ 32c each
2500+ 26c each

Minimum one case pack.
Please allow 2 - 3 weeks for printed items from approved art.

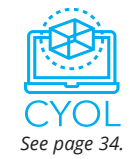

New

Available Colours



Perfectly partners with our Whisper series. As shown here with the Moonglow hinged boxes.

Mystique

- Texture paper wrapped 2-piece boxes with flocked foam pads
- Packaged in individual white sleeves

| CODE | DESCRIPTION | SIZE (inches) | CASE PACK | PRICE/EACH | |
|---------|-----------------|-----------------|-----------|------------|--------|
| | | | | 25+ | 500+ |
| A 31221 | Ring (R1) | 2.5 x 2.25 x 2 | 100 | \$2.49 | \$2.24 |
| B 31222 | Earring (EP4) | 2 x 1.5 x 1.187 | 100 | \$1.91 | \$1.72 |
| C 31263 | Utility (P3) | 3 x 3 x 2.125 | 100 | \$2.82 | \$2.54 |
| D 31293 | Bracelet (BL1R) | 9 x 2.375 x 1.5 | 50 | \$4.06 | \$3.65 |
| E 31273 | Necklace (N1) | 6.375 x 8 x 2 | 25 | \$5.82 | \$5.24 |

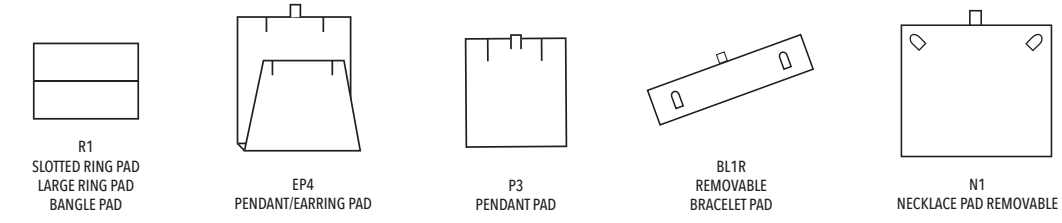
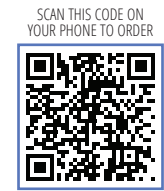

FOIL / PAD PRINT
F: inside and top lid / PP: inside and top lid
50/100+ 35c each
1000+ 32c each
2500+ 26c each

Minimum one case pack.
Please allow 2 - 3 weeks for printed items from approved art.

All print orders subject to set-up charges. Applicable artwork, and plate charges may apply. See page 98.

All print orders subject to set-up charges. Applicable artwork, and plate charges may apply. See page 98.

SPECIAL ORDER

Nest Boxes

Cotton Filled

| CODE | PRICE /EACH | |
|-------|-------------|--------|
| | 50+ | 1000+ |
| 31011 | \$1.03 | \$0.94 |
| 31021 | \$1.10 | \$1.00 |
| 31032 | \$1.23 | \$1.11 |
| 31033 | \$1.46 | \$1.32 |
| 31036 | \$1.64 | \$1.49 |
| 31034 | \$1.78 | \$1.62 |
| 31053 | \$1.70 | \$1.55 |
| 31065 | \$2.38 | \$2.17 |
| 31082 | \$1.60 | \$1.46 |
| 31085 | \$3.04 | \$2.76 |

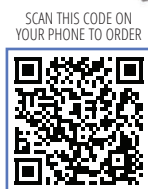

Minimum one case pack.
Estimated lead time - Please allow 3 weeks for unprinted items and 4 weeks for printed items from approved art.

FOIL / PAD PRINT
F: top lid only / PP: top lid only
50/100+ 35¢ each
1000+ 32¢ each
2500+ 26¢ each

Available Colours



| CODE | SIZE (inches) | CASE PACK | Available Colours | | | | | | | | | | | |
|-------|---------------------|-----------|-------------------|------|-----|-----|-----|-----|-----|-----|-----|------|------|-----|
| | | | 061 | 000K | 007 | 008 | 009 | 029 | 354 | 353 | 045 | 0155 | 015P | 055 |
| 31011 | 1.75 x 1.125 x .625 | 100 | ✓ | ✓ | ✓ | ✓ | - | - | - | - | - | ✓ | ✓ | - |
| 31021 | 2.5 x 1.5 x .875 | 100 | ✓ | ✓ | ✓ | ✓ | ✓ | ✓ | ✓ | ✓ | ✓ | ✓ | ✓ | ✓ |
| 31032 | 3 x 2.125 X 1 | 100 | ✓ | ✓ | ✓ | ✓ | ✓ | ✓ | ✓ | ✓ | ✓ | ✓ | ✓ | ✓ |
| 31033 | 3.5 x 3.5 x 1 | 100 | ✓ | ✓ | ✓ | ✓ | ✓ | ✓ | ✓ | ✓ | ✓ | ✓ | ✓ | ✓ |
| 31036 | 3.5 x 3.5 x 1.5 | 100 | - | ✓ | ✓ | ✓ | - | - | - | - | - | ✓ | ✓ | ✓ |
| 31034 | 3.5 x 3.5 x 2 | 100 | - | ✓ | ✓ | ✓ | - | - | - | - | - | ✓ | ✓ | ✓ |
| 31053 | 5.25 x 3.75 x .875 | 100 | ✓ | ✓ | ✓ | ✓ | ✓ | ✓ | ✓ | ✓ | ✓ | ✓ | ✓ | ✓ |
| 31065 | 6 x 5 x 1 | 50 | - | ✓ | ✓ | ✓ | ✓ | ✓ | ✓ | - | ✓ | ✓ | ✓ | ✓ |
| 31082 | 8 x 2 x .875 | 100 | - | ✓ | ✓ | ✓ | ✓ | ✓ | ✓ | - | ✓ | ✓ | ✓ | ✓ |
| 31085 | 8 x 5.5 x 1.25 | 50 | ✓ | ✓ | ✓ | ✓ | - | - | - | - | ✓ | ✓ | ✓ | ✓ |



| CODE | SIZE (inches) | CASE PACK | Available Colours | | | | | | | | | | | |
|-------|---------------------|-----------|-------------------|-----|-----|-----|-----|-----|-----|-----|-----|-----|-----|-----|
| | | | 093 | 098 | 099 | 060 | 056 | 028 | 025 | 026 | 076 | 075 | 081 | 019 |
| 31011 | 1.75 x 1.125 x .625 | 100 | - | - | - | - | - | - | - | - | - | ✓ | ✓ | - |
| 31021 | 2.5 x 1.5 x .875 | 100 | ✓ | ✓ | ✓ | ✓ | ✓ | ✓ | ✓ | ✓ | ✓ | ✓ | ✓ | ✓ |
| 31032 | 3 x 2.125 X 1 | 100 | ✓ | ✓ | ✓ | ✓ | ✓ | ✓ | ✓ | ✓ | ✓ | ✓ | ✓ | ✓ |
| 31033 | 3.5 x 3.5 x 1 | 100 | ✓ | ✓ | ✓ | ✓ | ✓ | ✓ | ✓ | ✓ | ✓ | ✓ | ✓ | ✓ |
| 31036 | 3.5 x 3.5 x 1.5 | 100 | - | - | - | - | ✓ | - | - | - | ✓ | ✓ | - | - |
| 31034 | 3.5 x 3.5 x 2 | 100 | - | - | - | - | ✓ | - | - | - | ✓ | ✓ | - | - |
| 31053 | 5.25 x 3.75 x .875 | 100 | ✓ | ✓ | ✓ | ✓ | ✓ | ✓ | ✓ | ✓ | ✓ | ✓ | ✓ | ✓ |
| 31065 | 6 x 5 x 1 | 50 | ✓ | ✓ | ✓ | - | ✓ | - | ✓ | ✓ | ✓ | ✓ | ✓ | - |
| 31082 | 8 x 2 x .875 | 100 | ✓ | - | - | - | ✓ | - | - | - | ✓ | ✓ | - | - |
| 31085 | 8 x 5.5 x 1.25 | 50 | - | - | - | - | - | - | - | - | ✓ | ✓ | - | - |

Berkeley Series

Four sizes, including one that can accommodate gift cards, are available, each with a white flocked removable platform.

See page 61 for more information and for matching paper bags!
All are recyclable, reusable and biodegradable.



All print orders subject to set-up charges. Applicable artwork, and plate charges may apply. See page 98.

IN STOCK

Nest Boxes



These boxes match our **Damask Paper Shoppers** - page 63 and **Damask Pouches** - page 49



Damask

Style and substance in a simple packaging combination.

- Black and white 2-piece box
- 100% recycled board box
- Cotton fill pad wrapped with damask patterned tissue
- See our matching bag and pouch to complete your collection

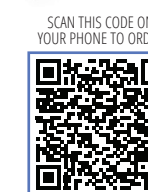

FOIL / PAD PRINT
F: top lid only / PP: top lid only
100+ 35¢ each
1000+ 32¢ each
2500+ 26¢ each

Estimated lead time: 2 - 3 weeks for printed items from approved art.

| CODE | DESCRIPTION | SIZE (inches) | CASE PACK | PRICE /EACH | |
|-----------|-------------|---------------|-----------|-------------|--------|
| | | | | 100+ | 1000+ |
| 31570153D | Earring | 3 x 2.125 x 1 | 100 | \$0.78 | \$0.67 |
| 31555153D | Brooch | 3.5 x 3.5 x 1 | 100 | \$0.92 | \$0.79 |
| 31564153D | Bracelet | 8 x 2 x .875 | 100 | \$1.08 | \$0.94 |
| 31558153D | Necklace | 6 x 5 x 1 | 100 | \$1.57 | \$1.33 |

Minimum order is one case pack.

White Swirl Pattern

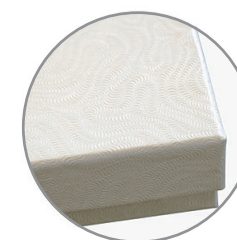

White Economy

Sometimes a simple box is all you need!

- Made with 100% recycled board covered with white swirl paper
- Cotton filled to hold jewellery in place



FOIL / PAD PRINT
F: top lid only / PP: top lid only
50/100+ 35¢ each
1000+ 32¢ each
2500+ 26¢ each

Estimated lead time: 2 - 3 weeks for printed items from approved art.

| CODE | DESCRIPTION | SIZE (inches) | CASE PACK | PRICE /EACH | |
|----------|-----------------|------------------|-----------|-------------|--------|
| | | | | 50+ | 1000+ |
| 31502103 | Charm | 2.5 x 1.5 x .875 | 100 | \$0.67 | \$0.59 |
| 31570103 | Earring | 3 x 2.125 x 1 | 100 | \$0.75 | \$0.63 |
| 31555103 | Brooch | 3.5 x 3.5 x 1 | 100 | \$0.85 | \$0.75 |
| 31564103 | Bracelet | 8 x 2 x .875 | 100 | \$0.96 | \$0.85 |
| 31558103 | Necklace | 6 x 5 x 1 | 50 | \$1.23 | \$1.11 |
| 31576103 | Large Necklace | 8 x 5.5 x 1.25 | 50 | \$1.90 | \$1.65 |
| 31259103 | Stand-Up Bangle | 3.5 x 2 x 2 x 2 | 100 | \$2.46 | \$2.21 |

Minimum order is one case pack.

All print orders subject to set-up charges. Applicable artwork, and plate charges may apply. See page 98.

SPECIAL ORDER

Gift Card Boxes



Monte Carlo Gift Card Box

People love gift cards, this box takes the presentation to a new level.

- Smooth paper hinged box with magnetic closure
- Removable insert holds card securely
- We suggest the black box with our gloss black GL2 print

| CODE | SIZE (inches) | CASE | PRICE/EACH | |
|-----------|---------------|------|------------|-------|
| | | | 100+ | 1000+ |
| 310239 __ | 5.125 x 4 x 1 | 100 | \$3.82 | |



FOIL / PAD PRINT

F: inside lid only / PP: inside and outside lid
 100+ 35¢ each
 1000+ 32¢ each
 2500+ 26¢ each
 Estimated lead time: 3 weeks for unprinted items and 4 weeks for printed items from approved art.



Gift Card Nest Box

- White paperboard platforms
- Silver or White exterior

| CODE | SIZE (inches) | CASE | PRICE/EACH | |
|-----------|------------------|------|------------|-------|
| | | | 100+ | 1000+ |
| 313230 __ | 3.5 x 2.25 x .75 | 100 | \$2.13 | |



Estimated lead time: 3 weeks for unprinted items and 4 weeks for printed items from approved art.



Gift Certificate Box

Minimum order is one case pack.

| CODE | SIZE (inches) | CASE PACK | PRICE/EACH | |
|-------------|---|-----------|------------|-------|
| | | | 100+ | 1000+ |
| 0922100 _ B | Gift Certificate Box Only see colour options 6.625 x 3.25 x .5 | 100 | \$2.68 | |

Gift Certificate Box Colour:



FOIL / PAD PRINT
 F and PP: top lid only
 100+ 35¢ each
 1000+ 32¢ each
 2500+ 26¢ each



IN STOCK Finishing Touches

Available to finish the look of your gift certificate/card.

Stretch Loops (100 pack min.)

| | |
|----------------|------------------|
| 09500607 6" - | Gold \$0.16/ea |
| 09500608 6" - | Silver \$0.16/ea |
| 09501007 10" - | Gold \$0.18/ea |
| 09501008 10" - | Silver \$0.18/ea |

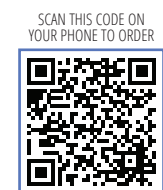

Dress it up with printed ribbon!
 See page 90.



IN STOCK

Gift Card Boxes



Black Box with Ribbon

Estimated lead time: 2 - 3 weeks for printed items from approved art.

Minimum order is one case pack.

| CODE | SIZE (inches) | CASE | PRICE/EACH | |
|----------|---------------|------|------------|--------|
| | | | 100+ | 1000+ |
| 31040315 | 4 x 3 x .625 | 100 | \$1.76 | \$1.34 |



FOIL / PAD PRINT

F and PP: inside and top lid
 100+ 35¢ each
 1000+ 32¢ each
 2500+ 26¢ each

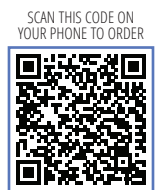

Pewter Box with Ribbon

Estimated lead time: 2 - 3 weeks for printed items from approved art.

Minimum order is one case pack.

| CODE | SIZE (inches) | CASE | PRICE/EACH | |
|----------|-------------------|------|------------|--------|
| | | | 50+ | 1000+ |
| 31040742 | 7.5 x 4.25 x .625 | 50 | \$2.42 | \$2.28 |



FOIL / PAD PRINT

F and PP: inside and top lid
 50+ 35¢ each
 1000+ 32¢ each
 2500+ 26¢ each



Gift Certificate and Box

Estimated lead time: 2 - 3 weeks for printed items from approved art.

| CODE | SIZE (inches) | CASE PACK | PRICE/EACH | |
|-----------|---|-----------|------------|-------|
| | | | 100+ | 1000+ |
| 09221002B | White Gift Certificate Box Only | 100 | \$2.68 | |
| 18197 | English Gift Certificate 6.375 x 3.125" folded | 100 | \$0.85 | |
| 18196 | French Gift Certificate 6.375 x 3.125" folded | 100 | \$0.85 | |

Gift certificates are pre-numbered.

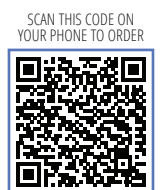

FOIL / PAD PRINT

F and PP: certificate and top lid
 100+ 35¢ each
 1000+ 32¢ each
 2500+ 26¢ each

Minimum order is one case pack.

All print orders subject to set-up charges. Applicable artwork, and plate charges may apply. See page 98.

All print orders subject to set-up charges. Applicable artwork, and plate charges may apply. See page 98.

SPECIAL ORDER

Pouches

Natural Jute and Natural Cotton

• Minimum 100 per size.
Estimated lead time: 6 weeks for printed items from approved art.



Natural Cotton - FOIL PRINT ONLY

| CODE | SIZE (in.) | PRICE /EACH | |
|------------|------------|-------------|--------|
| | | 100+ | 1000+ |
| 09030400NC | 3 x 4 | \$0.64 | \$0.52 |
| 09050600NC | 5 x 6 | \$0.90 | \$0.74 |
| 09061000NC | 6 x 10 | \$1.36 | \$1.11 |
| 09081200NC | 8 x 12 | \$1.82 | \$1.49 |

Natural Jute - NO PRINT

| CODE | SIZE (in.) | PRICE /EACH | |
|------------|------------|-------------|--------|
| | | 100+ | 1000+ |
| 09050500NJ | 3 x 5 1/2 | \$1.18 | \$0.97 |
| 09050600NJ | 5 x 6 | \$1.40 | \$1.14 |
| 09061000NJ | 6 x 10 | \$1.85 | \$1.52 |

FOIL PRINT
100+ 32c each
1000+ 29c each
2500+ 24c each

Organza

| CODE | SIZE (inches) | PRICE /EACH | |
|-------------|---------------------|-------------|--------|
| | | 100+ | 1000+ |
| A 09905 ___ | 2 x 2.5 | \$0.45 | \$0.37 |
| B 09910 ___ | 3 x 4 | \$0.48 | \$0.39 |
| C 09915 ___ | 4 x 5.5 | \$0.63 | \$0.51 |
| D 09920 ___ | 5 x 6.5 | \$0.72 | \$0.59 |
| E 09925 ___ | 5.5 x 9 | \$1.07 | \$0.87 |
| F 09930 ___ | 6 x 14 | \$1.25 | \$1.01 |
| G 09950 ___ | 22 x 25 (not shown) | \$4.13 | \$3.31 |

Organza Colours (Not exactly as shown.)

| | | |
|--------------------|-------------------|--------------------|
| Black - 030 | Silver - 012 | White - 029 |
| Hunter - 589 | Navy - 370 | Smoke Blue - 337 |
| Lt. Blue - 305 | Burgundy - 276 | Ultra Violet - 467 |
| Purple - 465 | Lavender - 430 | Copper - 073 |
| Orange - 750 | Olive - 563 | Mint - 530 |
| Red - 250 | Pink - 115 | Gold - 690 |
| Baby Maize - 617 | Ivory - 810 | Mauve - 161 |
| Pastel Green - 513 | Fruit Punch - 155 | Yellow - 645 |
| Turquoise - 340 | Royal - 350 | Fuchsia - 187 |

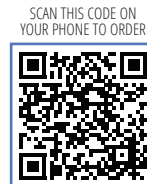

Minimum 100 per size/colour.

Estimated lead time: 6 weeks for printed items from approved art.
Foil printed to be determined.

FOIL PRINT - TBD
100+ 35c each
1000+ 32c each
2500+ 26c each

A is only available in Silver, White, Pink, Lavender, Gold and Ivory.

F not available in Fruit Punch, Orange, Royal, Turquoise and Yellow.

G is only available in Silver, White, Pink, Red, Burgundy, Lt. Blue, Royal, Lavender, Mint, Olive, Gold and Ivory.

Gold - 690 MOQ of 1000 pieces and 6-8 weeks lead time.

IN STOCK

Pouches

Geo Series

• Minimum case pack 12.

Estimated lead time: 2 - 3 weeks for printed items from approved art.



| CODE | TYPE | SIZE (in.) | PRICE /EACH | |
|-------------|---------------------------|------------|-------------|--------|
| | | | 12+ | 144+ |
| A 09030415B | Geo Pouch with Black Box | 3 x 4 | \$2.91 | \$2.47 |
| B 09030456P | Geo Pouch with Purple Box | 3 x 4 | \$2.91 | \$2.47 |
| C 09030427T | Geo Pouch with Bronze Box | 3 x 4 | \$2.91 | \$2.47 |

FOIL / PAD PRINT
F and PP: pouch and packer lid
12+ 35c each
144+ 32c each
504+ 26c each

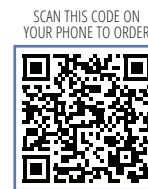

Estimated lead time: 2 - 3 weeks for printed items from approved art.

FOIL / PAD PRINT
100+ 35c each
1000+ 32c each
2500+ 26c each

+ Bell Pouches and Wedding Pouch minimums:

FOIL / PAD PRINT
12+ 35c each
144+ 32c each
504+ 26c each

IN STOCK

Pouches

Microfiber

• Minimum case pack 100

Economical packaging for inexpensive items or repairs.



| CODE | COLOUR | SIZE (inches) | PRICE /EACH | |
|----------|--------|---------------|-------------|--------|
| | | | 100+ | 500+ |
| 09040315 | Black | 4 x 3 | \$1.33 | \$1.17 |
| 09050415 | Black | 5-1/2 x 4 | \$1.98 | \$1.68 |
| 09040311 | Blue | 4 x 3 | \$1.33 | \$1.17 |
| 09050411 | Blue | 5-1/2 x 4 | \$1.98 | \$1.68 |

Damask Pouches



Envelope Pouches with snap closure



Microfiber Bell Pouches +



White Leatherette Pouches



Velveteen Pouches



Wedding Pouches +



• Minimum case pack of 100

**See chart for 2-piece SPECIAL ORDER outer box for the Velveteen pouches.

| CODE | TYPE | SIZE (in.) | CASE PACK | PRICE/EACH | |
|-------------|-------------------------------|----------------|-----------|------------|--------|
| | | | | 100+ | 1000+ |
| A 09040515D | Large Damask Pouch | 5.5 x 4 | 100 | \$3.01 | \$2.47 |
| B 09030315D | Small Damask Pouch | 3 x 3 | 100 | \$1.93 | \$1.75 |
| C 09304715 | Large Envelope Pouch | 3 x 4 | 100 | \$2.94 | \$2.78 |
| D 09203715 | Small Envelope Pouch | 2.375 x 2.75 | 100 | \$2.27 | \$2.08 |
| E 09525115B | Large Microfiber Bell Pouch | 4.375 x 5.3751 | 12 | \$1.53 | \$1.31 |
| F 09324115B | Small Microfiber Bell Pouch | 3.25 x 4.5 | 12 | \$1.23 | \$1.06 |
| G 09314700 | Large White Leatherette Pouch | 3 x 4 | 100 | \$1.05 | \$0.92 |
| H 09203700 | Small White Leatherette Pouch | 2.75 x 3.25 | 100 | \$0.75 | \$0.67 |
| I 09314807 | Gold Metallic Pouch | 3 x 4 | 100 | \$0.81 | \$0.79 |
| J 09405 ___ | *Velveteen Pouches | 4 x 5.5 | 100 | \$1.01 | \$0.68 |
| K 09314 ___ | *Velveteen Pouches | 3 x 4 | 100 | \$0.83 | \$0.57 |
| 31314003 | White 2-piece outer box** | 3.25 x 4.25 | 100 | \$1.34 | \$1.22 |
| 31065000K | White 2-piece outer box | 6 x 5 x 1 | 50 | \$2.38 | \$2.17 |
| L 37501006 | White Wedding Pouches | 1.875 x 2.5 | 12 | \$1.08 | \$0.87 |

* See photo for colour code

All print orders subject to set-up charges. Applicable artwork, and plate charges may apply. See page 98.

All print orders subject to set-up charges. Applicable artwork, and plate charges may apply. See page 98.

SPECIAL ORDER

Jewellery Care

Customize with your store brand!

Quality professional jewellery care, such as LAVISH, starts as an add-on sale or complimentary gift with purchase and keeps customers coming back for more. Every time customers clean their jewellery with customized LAVISH jewellery care, they will think of your store.

SCAN THIS CODE ON YOUR PHONE TO ORDER



Estimated lead time: 3-4 weeks for printed items from approved art.

Full Colour Digital Printed Labels

Create your own full colour look or our artist can create a design for your approval. Estimated lead time: 3 - 4 weeks for custom printed items from approved art.



Lavish Jewellery Bath

8 fl. oz. (236 ml)
04530000C \$5.93 ea
 Minimum order 150 jars



Lavish Polishing Cloth

6" x 4" - Slate Grey with Vellum Envelope
04540000C \$5.21 ea

Screen print colours: Black, Silver, Gold or White
 Minimum order 200 cloths



Lavish Foam

1.69 fl. oz. (50 ml) 2.5 fl. oz. (75 ml)
04510050C \$6.97 ea **04510075C** \$9.13 ea
 Minimum order 96 bottles per size



Lavish Click Clean Pen

.108 fl. oz. (3.2 ml)
04520000C \$7.40 ea
 Minimum order 100 pens



Non-Toxic



Made in the USA



Biodegradable



Safe

User and Eco Friendly. Lavish is a bio-based cleaning formula that contains no harsh chemicals, peroxides, phosphates, or ammonia.

Lavish was developed and is made by a 3rd generation jeweller/gemologist whose ambition is to provide you with the safest, and most effective product available.

Lavish is biodegradable. It breaks down rapidly and completely, meaning it will not contaminate or pollute our water, or our environment.

Lavish is safe for you, your jewelry, and our planet. From costume jewelry to your heirloom pieces, Lavish will bring back the sparkle and shine without the worry.

Diamond & Gem Cloths

Microfiber Cloth removes small dust, oily film, fingerprints and other residue from fine jewellery. Chemical Free. Lint Free. AVAILABLE IN LIGHT BLUE ONLY. Estimated lead time: 4 - 6 weeks for custom printed cloths from approved art.

8 x 8" Blue Cloth **04780800C** \$5.12 ea
 Minimum order is 144 cloths.



IN STOCK

Jewellery Care

Available for immediate shipment.

We care about your jewellery as much as you do!



We care about your jewellery, that's why we use better ingredients, better packaging, and you get better performance to keep you sparkling brighter all day long. Use Lavish everyday to safely and conveniently make your jewellery sparkle and shine more than it ever has.



SCAN THIS CODE ON YOUR PHONE TO ORDER



Lavish Jewellery Bath

Jewellery bath includes 1 pod of our jewellery cleaner concentrate. An effective jewellery cleaner that can be used on all jewellery from Pearls and Opals to Diamonds without the risk of damage.

8 fl. oz. (236 ml)
04530000 \$6.23 ea
 50 per case pack



Lavish Polishing Cloth

Gold, Silver, Platinum oh my!

Bring back the shine of all your metals with the Lavish signature polishing cloth. Our polishing cloth is infused with a gentle and effective polishing compound that will bring back the luster and shine to your jewellery. Great for use on gold, silver, platinum, and other precious metals.

Note: To avoid the possibility of small scratches, care should be taken to avoid contact with stones other than diamonds. 8 fl. oz. (236 ml)

6" x 4" - Slate Grey with Vellum Envelope
04540000 \$5.47 ea
 50 per case pack

Lavish Foam

Our Lavish Jewellery Cleaning Foam is our #1 customer favorite product. The foam is a special blend of bio-based surfactants that coalesce in a foam to efficiently break down the daily buildup of grime and allow it to be easy rinsed away leaving nothing but sparkle and shine. The foam is dispensed through a non-aerosol pump foamer, so there are no nasty propellants to damage our ozone layer.

1.69 fl. oz. (50 ml) 2.5 fl. oz. (75 ml)
04510050 \$7.31 ea **04510075** \$9.58 ea
 48 per case pack per size



Lavish Click Clean Pen

The Lavish Click Clean Pen is the ultra portable, ultra quick way to put the bling back in your ring. The non-toxic formulation is safe for all your jewellery and is ready to go whenever, wherever you are. The one-handed click action gives you control so you can dispense just the right amount of cleaning solution onto your jewellery. The soft brush tip makes it easy to get into hard to reach areas of your jewellery and underneath stones.

.108 fl. oz. (3.2 ml)
04520000 \$7.77 ea 50 per case pack



Handling Gloves

White microfiber. One size fits all
 The natural oils in our skin can often leave displeasing marks on jewellery. Our microfiber, lint-free gloves are ideal for handling and protecting your most precious inventory.

05000296 \$2.95 /pair
 Minimum order - 6 pairs

IN STOCK

Jewellery Care

Estimated lead time: 2 - 3 weeks for printed items from approved art.

Repair Envelopes

 **NO PLATE CHARGES!**

| CODE | DESCRIPTION | SIZE (in) | 1000 | 3000 | 5000 | 10000 |
|-------------|---------------------------------|-------------|--------|--------|--------|--------|
| A 09850000 | 2-Part NCR | 4.25 x 9 | \$0.41 | \$0.37 | \$0.32 | \$0.26 |
| B 09845200 | Plain-no perf., text or numbers | 3.5 x 6.125 | \$0.18 | \$0.16 | \$0.15 | \$0.14 |
| C 09845300 | Double Perforated | 3.5 x 6.125 | \$0.22 | \$0.19 | \$0.16 | \$0.14 |
| D 09845400 | Single Perforated | 3.5 x 6.125 | \$0.24 | \$0.21 | \$0.18 | \$0.15 |
| E 09850000E | 2-part NCR - NO PRINT | 4.25 x 9 | \$0.30 | \$0.30 | \$0.30 | \$0.30 |

SCAN THIS CODE ON YOUR PHONE TO ORDER



• Prices include one colour printing. A second colour is \$ 0.029/each.
Minimum 1000 per style. Printing colours: Black, Red, Green and Blue



Please allow 2 - 3 weeks for printing.
\$37 set-up charge applies.

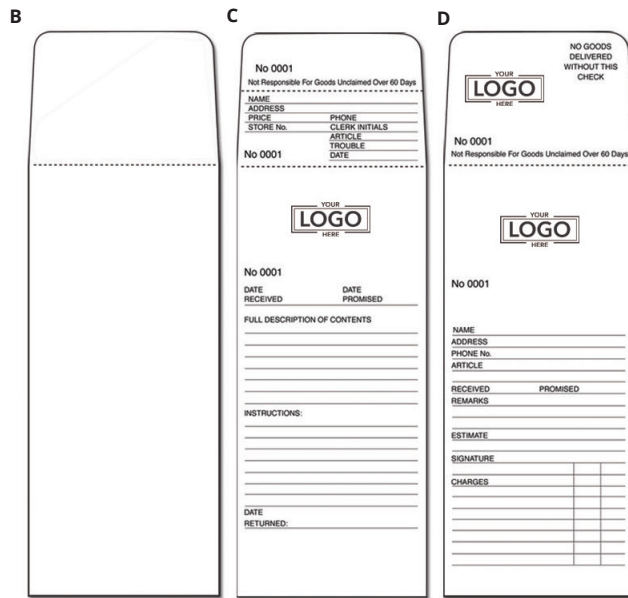

Tags and Miscellaneous Accessories



SCAN THIS CODE ON YOUR PHONE TO ORDER



| CODE | DESCRIPTION | PACK MIN. | PRICE |
|------------|-----------------------------------|-----------|----------|
| E 08270207 | Plastic Ring Tags - Gold | Box/1000 | \$136.21 |
| F 08270208 | Plastic Ring Tags - Silver | Box/1000 | \$136.21 |
| G 08090707 | Plastic With String Tags - Gold | Box/1000 | \$136.21 |
| H 08090708 | Plastic With String Tags - Silver | Box/1000 | \$136.21 |
| I 08810800 | Super Mylar Ring Tags - Wide | Box/1000 | \$53.66 |
| J 08810700 | Super Mylar Ring tags - Narrow | Box/1000 | \$35.77 |
| 08833000 | Fine Pen Marker (not shown) | 1 | \$15.13 |



BAGS

EUROTOTES, SHOPPERS, CYOL, REUSABLE & APPAREL



Available for immediate shipping for above items.

All print orders subject to set-up charges. Applicable artwork, and plate charges may apply. See page 98.

IN STOCK

Rope Handle Eurototes

SCAN THIS CODE ON YOUR PHONE TO ORDER



BAGS



08V - Silver

Linen Paper Detail

Vantage II Eurototes
Available Colours



08V - Silver
Matches Vantage Silver
Hinged Packaging
See page 29.

07V - Gold
Matches Vantage Gold
Hinged Packaging
See page 29.

Vantage II Eurototes

- 150 gsm uncoated art paper
- 5 mm pp cord knotted handles
- Folded top turn and cardboard reinforced bottom
- Minimum order is 100 per colour per size

| CODE | SIZE (inches) | PRICE/EACH | | |
|--------------|--------------------|------------|--------|--------|
| | | 100+ | 500+ | 1000+ |
| A 230606 ___ | 6 x 3.5 x 6 x 3.5 | \$1.28 | \$1.17 | \$1.01 |
| B 231008 ___ | 10.5 x 5 x 8.5 x 5 | \$1.63 | \$1.46 | \$1.25 |

Estimated lead time: 2 - 3 weeks for printed items from approved art.



FOIL PRINT
100+ 35¢ each
1000+ 32¢ each
2500+ 26¢ each

Eclipse and Geo Eurototes
Available Colours



56G - Purple
Matches Geo Purple
Hinged Packaging
See page 23.

27G - Bronze
Matches Geo Bronze
Hinged Packaging
See page 23.

27G - Bronze



Shimmer Paper Detail

Eclipse and Geo Eurototes

- 150 gsm uncoated art paper
- 5 mm pp cord knotted handles
- Folded top turn and cardboard reinforced bottom
- Minimum order is 100 per colour per size



66E - Aubergine
Matches Eclipse Aubergine
Hinged Packaging
See page 19.

81E - Blue
Matches Eclipse Blue
Hinged Packaging
See page 19.

IN STOCK

Luxury Grosgrain Handle Eurototes

BAGS



Luxury Grosgrain Handle Eurototes

- Gloss and matte lamination
- 157 gsm art paper
- 7/8" matching grosgrain, knotted handles
- Fold over top turn and cardboard reinforced bottom
- Minimum order is 100 per colour per size

| CODE | SIZE (inches) | CASE PACK | PRICE/EACH | | |
|---------------|----------------------|-----------|------------|--------|--------|
| | | | 100+ | 500+ | 1000+ |
| A 230606 ___ | 6 x 3 x 6 x 3 | 100 | \$1.18 | \$1.06 | \$0.91 |
| B 230810 ___ | 8 x 4 x 10 x 4 | 100 | \$1.24 | \$1.12 | \$0.96 |
| C 231209 ___ | 12.5 x 4.5 x 9 x 4.5 | 100 | \$1.49 | \$1.34 | \$1.15 |
| D 231612 ___ | 16 x 6 x 12 x 6 | 100 | \$2.03 | \$1.83 | \$1.56 |
| E 232014 ___* | 20 x 6 x 14 x 6 | 100 | \$2.27 | \$2.04 | \$1.76 |

* champagne and pewter not available in this size.

Estimated lead time: 2 - 3 weeks for printed items from approved art.

Available Colours



FOIL PRINT
100+ 35¢ each
1000+ 32¢ each
2500+ 26¢ each



TRANSFER PRINT
100+ \$2.45 each
1000+ \$2.25 each
300 bags minimum



15BM Black Matte 15BG Black Gloss 02C Champagne 08P Pewter 00W White

SCAN THIS CODE ON YOUR PHONE TO ORDER



IN STOCK

Eco-Lux Eurototes

New



Eco-Lux Eurototes

- 100% recyclable
- 138 gsm art paper
- 8 mm paper rope handle
- Folded top turn and cardboard reinforced bottom
- Minimum order is 100 per colour per size

| CODE | TYPE | SIZE (inches) | CASE PACK | PRICE/EACH | | |
|---------------|------------|-------------------|-----------|------------|--------|--------|
| | | | | 100+ | 500+ | 1000+ |
| A 239606 __ | Novelty | 6 x 3.5 x 6 x 3.5 | 100 | \$1.17 | \$1.04 | \$0.91 |
| B 239709 __ | Small gift | 9 x 3.5 x 7 x 3.5 | 100 | \$1.33 | \$1.14 | \$1.02 |
| C 239810 __ | Gift | 8 x 4 x 10 x 4 | 100 | \$1.46 | \$1.25 | \$1.14 |
| D 230908 __ T | Trapezoid | 9/7 x 4 x 8.5 x 4 | 100 | \$1.72 | \$1.40 | \$1.34 |
| E 238116 __ | Fashion | 16 x 6 x 12 x 6 | 100 | \$2.70 | \$2.37 | \$2.06 |
| F 231011 __ | Watch | 10 x 5 x 11 x 5 | 100 | \$1.88 | \$1.55 | \$1.38 |



Estimated lead time: 2 - 3 weeks for printed items from approved art.

- FOIL PRINT**
100+ 35¢ each
1000+ 32¢ each
2500+ 26¢ each
- DIGITAL PRINT***
1-999 62¢ each
1000-2999 40¢ each
3000+ 35¢ each
- TRANSFER PRINT**
100+ \$2.45 each
1000+ \$2.25 each
300 bags minimum

*Best printed on white.



| | 15-Black | 00-White | 07-Gold | 08-Silver | 42-Brown | 11-Blue | 10-Green |
|------------|----------|----------|---------|-----------|----------|---------|----------|
| Novelty | ✓ | ✓ | ✓ | ✓ | ✓ | ✓ | ✓ |
| Small Gift | ✓ | ✓ | ✓ | ✓ | ✓ | ✓ | ✓ |
| Gift | ✓ | ✓ | ✓ | ✓ | ✓ | ✓ | ✓ |
| Trapezoid | ✓ | ✓ | ✓ | — | ✓ | — | — |
| Fashion | ✓ | ✓ | ✓ | ✓ | ✓ | — | — |
| Watch | ✓ | ✓ | ✓ | — | — | — | — |

All print orders subject to set-up charges. Applicable artwork, and plate charges may apply. See page 98.

IN STOCK

All Paper Eurototes



All Paper Eurotote with Paper Rope Handle

- 100% recyclable
- 40% post-consumer waste
- 190 gsm uncoated paper
- 8 mm paper cord knotted handles
- Folded top turn and cardboard reinforced bottom
- Minimum order is 100 per colour per size

| CODE | SIZE (inches) | CASE PACK | PRICE/EACH | | |
|------------------|-------------------|-----------|------------|--------|--------|
| | | | 100+ | 500+ | 1000+ |
| A 230606 _ _ _ _ | 6 x 3.5 x 6 x 3.5 | 100 | \$0.99 | \$0.88 | \$0.75 |
| B 230810 _ _ _ _ | 8 x 4 x 10 x 4 | 100 | \$1.08 | \$0.95 | \$0.81 |
| C 231013 _ _ _ _ | 10 x 5 x 13 x 5 | 100 | \$1.23 | \$1.08 | \$0.91 |
| D 231612 _ _ _ _ | 16 x 6 x 12 x 6 | 100 | \$1.85 | \$1.64 | \$1.40 |

Estimated lead time: 2 - 3 weeks for printed items from approved art.
*Black and Navy bags cannot be digital printed.

- FOIL PRINT**
100+ 35¢ each
1000+ 32¢ each
2500+ 26¢ each
- DIGITAL PRINT**
1-999 62¢ each
1000-2999 40¢ each
3000+ 35¢ each

*Best printed on kraft, white and cream bags.

Available Colours



All print orders subject to set-up charges. Applicable artwork, and plate charges may apply. See page 98.

CREATE YOUR OWN LOOK

Full Colour Paper Eurototes

Make a creative impression...
the combinations are endless!



Prices include up to 2 ink print colours:

| TYPE | SIZE (inches) |
|------------|------------------------|
| Novelty | 6 x 3.5 x 6 x 3.5 |
| Small Gift | 9 x 3.5 x 7 x 3.5 |
| Gift | 8 x 4 x 10 x 4 |
| Trapezoid | 9/7 x 4 x 8.5 x 4 |
| Wine | 3.375 x 3.5 x 13 x 3.5 |
| Fashion | 16 x 6 x 12 x 6 |
| Saville | 16 x 6 x 19 x 6 |

Prices include 4 colour process print:

| TYPE | SIZE (inches) |
|------------|------------------------|
| Novelty | 6 x 3.5 x 6 x 3.5 |
| Small Gift | 9 x 3.5 x 7 x 3.5 |
| Gift | 8 x 4 x 10 x 4 |
| Trapezoid | 9/7 x 4 x 8.5 x 4 |
| Wine | 3.375 x 3.5 x 13 x 3.5 |
| Fashion | 16 x 6 x 12 x 6 |
| Saville | 16 x 6 x 19 x 6 |

- Combination foil print and ink printing available.
- No charge for printing plates (proof charge applies)
- Substitute a satin ribbon handle for the standard rope
- Add metal grommets to your bag



Unique printing options available.

Double Stamping shown here.

Estimated lead time: 14 - 16 weeks for delivery from approved art.



Create Your Own Look:

Choose your bag style. Send us your artwork. For 100% full colour design, speak to your sales representative.

SPECIAL ORDER



Manhattan Eurototes

- Made with 40% PCW*
- Made with 75% PCW**
- Biodegradable
- 5/8" poly/cotton twill knotted handle
- Recyclable once handle has been removed
- Folded top turn and cardboard reinforced bottom

SCAN THIS CODE ON YOUR PHONE TO ORDER



12" Wide Gussets!



| CODE | TYPE | CASE | PRICE/EACH | | |
|-------------|------------|------|------------|--------|--------|
| | | | 100+ | 500+ | 1000+ |
| A 245845 __ | Mini | 100 | \$1.31 | \$1.24 | \$1.18 |
| B 245841 __ | Petite | 100 | \$1.64 | \$1.55 | \$1.48 |
| C 245843 __ | Vanity | 100 | \$2.08 | \$1.97 | \$1.87 |
| D 245844 __ | Fashion | 100 | \$2.85 | \$2.70 | \$2.56 |
| E 245860 __ | X-Large | 50 | \$4.39 | \$4.16 | \$3.95 |
| F 245898 __ | Bottle Bag | 100 | \$1.80 | \$1.70 | \$1.62 |

| CODE | TYPE | CASE | PRICE/EACH | | |
|----------|----------------|------|------------|--------|--------|
| | | | 100+ | 500+ | 1000+ |
| 24585615 | Medium - Black | 100 | \$5.85 | \$5.55 | \$5.27 |
| 24585715 | Large - Black | 100 | \$6.55 | \$6.20 | \$5.89 |
| 24585600 | Medium - White | 100 | \$5.85 | \$5.55 | \$5.27 |
| 24585700 | Large - White | 100 | \$6.55 | \$6.20 | \$5.89 |
| 24585675 | Medium - Kraft | 100 | \$5.85 | \$5.55 | \$5.27 |
| 24585775 | Large - Kraft | 100 | \$6.55 | \$6.20 | \$5.89 |

Available Colours



Estimated lead time: 3 - 5 weeks for printed items from approved art.



FOIL PRINT
100+ 35¢ each
1000+ 32¢ each
2500+ 26¢ each



TRANSFER PRINT
100+ \$2.45 each
1000+ \$2.25 each
300 bags minimum

| Style | 15* Black | 00* White | 75** Kraft | 08* Grey | 09* Red | 41* Fuchsia | 11** Navy | 61* Green |
|---|-----------|-----------|------------|----------|---------|-------------|-----------|-----------|
| Mini 5 x 4 x 6 x 4 in | ✓ | ✓ | ✓ | ✓ | ✓ | ✓ | ✓ | ✓ |
| Petite 8 x 4 x 10 x 4 in | ✓ | ✓ | ✓ | ✓ | ✓ | ✓ | ✓ | ✓ |
| Vanity 10 x 5 x 13 x 5 in | ✓ | ✓ | ✓ | ✓ | ✓ | ✓ | ✓ | ✓ |
| Fashion 16 x 6 x 12 x 6 in | ✓ | ✓ | ✓ | ✓ | ✓ | ✓ | ✓ | ✓ |
| X-Large 20 x 6 x 14 x 6 in | ✓ | ✓ | ✓ | — | — | — | — | — |
| Bottle 4.5 x 4.5 x 15 x 4.5 in | ✓ | ✓ | ✓ | — | ✓ | — | — | — |
| Wide Gusset Medium 12.5 x 12 x 12 x 12 in. | ✓ | ✓ | ✓ | — | — | — | — | — |
| Wide Gusset Large 16 x 12 x 11 x 12 in. | ✓ | ✓ | ✓ | — | — | — | — | — |

All print orders subject to set-up charges. Applicable artwork, and plate charges may apply. See page 98.

All print orders subject to set-up charges. Applicable artwork, and plate charges may apply. See page 98.

SPECIAL ORDER

SPECIAL ORDER

Paper Shoppers

BAGS

BAGS



Thick Woven Handle Detail

Available Colours



Available Colours



5th Avenue Eurototes

- Embossed laminated finish with printed gloss and coordinating colour interior, 210 gsm
- Woven handles, top slit style, W fold bottom with removable bottom board
- Minimum order is 100 per colour per size

| CODE | SIZE (inches) | CASE PACK | PRICE/EACH | |
|--------------|----------------------|-----------|------------|--------|
| | | | 100+ | 1000+ |
| A 245820 __ | 8 x 3.5 x 6 x 3.5 | 100 | \$3.37 | \$3.19 |
| B 245821 __ | 12.5 x 4.5 x 9 x 4.5 | 100 | \$5.34 | \$5.06 |
| C 245822 ___ | 17 x 6 x 12.75 x 6 | 100 | \$7.29 | \$6.90 |

SCAN THIS CODE ON YOUR PHONE TO ORDER



FOIL PRINT
100+ 35¢ each
1000+ 32¢ each
2500+ 26¢ each



TRANSFER PRINT
100+ \$2.45 each
1000+ \$2.25 each
300 bags minimum

San Fran Natural Shoppers

Simple yet striking keyline design collection.



SCAN THIS CODE ON YOUR PHONE TO ORDER



| CODE | SIZE (inches) | CASE PACK | PRICE/EACH | | |
|-----------|-----------------|-----------|------------|--------|--------|
| | | | 100+ | 500+ | 1000+ |
| 249703 __ | 7 x 3 x 7 x 3 | 100 | \$1.19 | \$1.14 | \$1.10 |
| 249704 __ | 10 x 4 x 10 x 4 | 100 | \$1.54 | \$1.49 | \$1.44 |
| 249711 __ | 16 x 6 x 12 x 6 | 100 | \$2.25 | \$2.17 | \$2.09 |

Please allow 2 - 3 weeks for printed items from approved art.



FOIL PRINT
100+ 35¢ each
1000+ 32¢ each
2500+ 26¢ each



DIGITAL PRINT
Only on white and kraft.
1-999 62¢ each
1000-2999 40¢ each
3000+ 35¢ each



TRANSFER PRINT
100+ \$2.45 each
1000+ \$2.25 each
300 bags minimum



INK PRINT
100+ 34¢ each
1000+ 29¢ each
2500+ 24¢ each

*Best printed on white and kraft bags.



Tints and Pinstripe on Kraft

- Twist paper handle
- 120 gsm paper

SCAN THIS CODE ON YOUR PHONE TO ORDER



Pinstripe Detail

Tints on Kraft



Pinstripe on Kraft



| CODE | DESCRIPTION | SIZE (inches) | CASE PACK | PRICE/EACH |
|-------------|-------------|-----------------|-----------|------------|
| 230508 ____ | Prime | 5 x 3 x 8 x 3 | 250 | \$0.97 |
| 230809 ____ | Petite | 8 x 4.5 x 10 | 250 | \$1.00 |
| 231611 ____ | Fashion | 16 x 6 x 12 x 6 | 250 | \$1.57 |



TRANSFER PRINT
250+ \$2.45 each
1000+ \$2.25 each
300 bags minimum



INK PRINT
250+ 34¢ each
1000+ 29¢ each
2500+ 24¢ each

Estimated lead time:
Approx. 6 weeks for No Print Bags.
Approx 8 - 10 weeks for Printed items from approved art.

Berkeley Nest Boxes

Coordinating with San Fran Natural Shoppers, these 2-piece boxes finish the look.

- Glossy paper
- White flocked platform inserts

| CODE | SIZE (inches) | CASE PACK | PRICE/EACH | |
|-----------|---------------|-----------|------------|--------|
| | | | 100+ | 1000+ |
| 32201 ___ | 3 x 3 x 1.25 | 100 | \$1.84 | \$1.75 |
| 32202 ___ | 3.5 x 3.5 x 2 | 100 | \$2.79 | \$2.64 |
| 32203 ___ | 5 x 5 x 1.5 | 100 | \$3.49 | \$3.31 |
| 32204 ___ | 9 x 4.5 x 2* | 100 | \$4.38 | \$4.15 |

* 231 - Black, 849 - Red and 505 - Kraft are not available in this size.



FOIL / PAD PRINT
F: top lid only / PP: top lid only
100+ 35¢ each
1000+ 32¢ each
2500+ 26¢ each

Minimum one case pack.
Estimated lead time - Please allow 3 weeks for unprinted items and 4 weeks for printed items from approved art.

Available Colours



100% Recycled Board

SCAN THIS CODE ON YOUR PHONE TO ORDER



CREATE YOUR OWN LOOK

Full Colour Simply Paper Shoppers

Make a creative impression...
the combinations are endless!



Simply Paper Shoppers

Kraft with paper twist handles, print 1 colour on 2 sides <25%

| TYPE | SIZE (inches) | CASE PACK |
|-----------|-------------------|-----------|
| Prime | 5.25 x 3.5 x 8.25 | 250 |
| Petite | 8 x 4 x 10 | 250 |
| Vanity | 10 x 5 x 13 | 250 |
| Celebrity | 13 x 6 x 15.5 | 250 |
| Fashion | 16 x 6 x 12 | 250 |
| Saville | 16 x 6 x 19 | 200 |
| Universal | 18 x 6 x 19 | 200 |
| Wine | 5.25 x 3.5 x 13 | 250 |

Any 2 Sizes
Minimum 3000
Special Pricing

White with paper twist handles, print 1 colour on 2 sides <25%

| TYPE | SIZE (inches) | CASE PACK |
|-----------|-------------------|-----------|
| Prime | 5.25 x 3.5 x 8.25 | 250 |
| Petite | 8 x 4 x 10 | 250 |
| Vanity | 10 x 5 x 13 | 250 |
| Celebrity | 13 x 6 x 15.5 | 250 |
| Fashion | 16 x 6 x 12 | 250 |
| Saville | 16 x 6 x 19 | 200 |
| Universal | 18 x 6 x 19 | 200 |
| Wine | 5.25 x 3.5 x 13 | 250 |

Any 2 Sizes
Minimum 3000
Special Pricing



Create Your Own Look:
Choose your bag style.
Send us your artwork.
For 100% full colour
design, speak to your
sales representative.



96% Recycled Material

• Minimum 5,000 per size or any
2 sizes, minimum 3000 per size

• Add a second colour

• Go 100% ink coverage

• Add a rope handle

Estimated lead time: 12 - 14
weeks for printed items from
approved art.



| CODE | TYPE | SIZE (inches) | CASE | 12 - Kraft PRICE/EACH | | 00 - White PRICE/EACH | | Tints PRICE/EACH | | Metallics PRICE/EACH | |
|----------|--------------|-----------------------|------|--------------------------|--------|--------------------------|--------|---------------------|--------|-------------------------|--------|
| | | | | 250+ | 1000+ | 250+ | 1000+ | 250+ | 1000+ | 250+ | 1000+ |
| 230508_* | Prime | 5 x 3.5 x 8 x 3.5 | 250 | \$0.44 | \$0.37 | \$0.55 | \$0.43 | \$0.68 | \$0.57 | \$0.61 | \$0.52 |
| 230809_ | Petite | 8 x 4.5 x 10.75 x 4.5 | 250 | \$0.50 | \$0.44 | \$0.55 | \$0.47 | \$0.71 | \$0.64 | \$0.76 | \$0.68 |
| 230914_ | Vanity | 10 x 5 x 13 x 5 | 250 | \$0.55 | \$0.52 | \$0.60 | \$0.55 | — | — | — | — |
| 231315_ | Celebrity | 13 x 6 x 15 x 6 | 250 | \$0.62 | \$0.57 | \$0.71 | \$0.66 | — | — | — | — |
| 231611_ | Fashion | 16 x 6 x 12 x 6 | 250 | \$0.61 | \$0.57 | \$0.66 | \$0.60 | \$0.87 | \$0.77 | \$1.20 | \$1.09 |
| 231619_ | Saville | 16 x 6 x 19 x 6 | ** | \$0.79 | \$0.67 | \$0.90 | \$0.79 | \$1.18 | \$1.08 | \$1.86 | \$1.73 |
| 231819_ | Universal | 18 x 7 x 18.75 x 7 | 200 | \$0.81 | \$0.71 | \$0.88 | \$0.79 | — | — | — | — |
| 230513_ | Wine Shopper | 5.25 x 3.5 x 13 | 250 | \$0.82 | \$0.76 | \$0.98 | \$0.91 | — | — | — | — |

Available Colours

| | 12- Kraft | 00- White | 35- Black | 41- Navy | 07- Gold | 08- Silver |
|-----------|-----------|-----------|-----------|----------|----------|------------|
| Prime | ✓ | ✓ | ✓ | ✓ | ✓ | ✓ |
| Petite | ✓ | ✓ | ✓ | ✓ | ✓ | ✓ |
| Vanity | ✓ | ✓ | — | — | — | — |
| Celebrity | ✓ | ✓ | — | — | — | — |
| Fashion | ✓ | ✓ | ✓ | ✓ | ✓ | ✓ |
| Saville | ✓ | ✓ | ✓ | ✓ | ✓ | ✓ |
| Universal | ✓ | ✓ | ✓ | ✓ | ✓ | ✓ |
| Wine | ✓ | ✓ | — | — | — | — |

* White and Kraft is 230508_ P

** Black, Navy, Gold and Silver 230508_ PR

** White and Kraft are sold in case packs of
200 and the Black, Navy, Gold and Silver are
sold in case packs of 250

**Sturdy, durable.
Our best value bags.**

FOIL PRINT
100+ 35¢ each
1000+ 32¢ each
2500+ 26¢ each

DIGITAL PRINT
Only on white and kraft.
1-999 62¢ each
1000-2999 40¢ each
3000+ 35¢ each

TRANSFER PRINT
100+ \$2.45 each
1000+ \$2.25 each
300 bags minimum

INK PRINT
100+ 34¢ each
1000+ 29¢ each
2500+ 24¢ each

Please allow 2 - 3 weeks for printed items from approved art.
*Best printed on kraft, white, gold and silver bags.



Damask Paper Shoppers

• 110 gsm paper
• Minimum order is 100 per size

| CODE | TYPE | SIZE (inches) | CASE PACK | PRICE/EACH | |
|-----------|---------|-----------------|-----------|------------|--------|
| | | | | 100+ | 1000+ |
| 23080915D | Petite | 8 x 4 x 10 x 4 | 100 | \$0.71 | \$0.62 |
| 23101315D | Vanity | 10 x 5 x 13 x 5 | 100 | \$0.76 | \$0.66 |
| 23161215D | Fashion | 16 x 6 x 12 x 6 | 100 | \$0.89 | \$0.76 |

Please allow 2 - 3 weeks for printed items from approved art.

FOIL PRINT
100+ 35¢ each
1000+ 32¢ each
2500+ 26¢ each

DIGITAL PRINT
1-999 62¢ each
1000-2999 40¢ each
3000+ 35¢ each

TRANSFER PRINT
100+ \$2.45 each
1000+ \$2.25 each
300 bags minimum

INK PRINT
100+ 34¢ each
1000+ 29¢ each
2500+ 24¢ each

All print orders subject to set-up charges. Applicable artwork, and plate charges may apply. See page 98.

IN STOCK

Paper Shoppers

The Mission Green Sustainable Solution for single-use plastic merchandise shoppers.



70% Recycled Material



Please allow 2 - 3 weeks for printed items from approved art.



FOIL PRINT
100+ 35¢ each
1000+ 32¢ each
2500+ 26¢ each



DIGITAL PRINT
1-999 62¢ each
1000-2999 40¢ each
3000+ 35¢ each



TRANSFER PRINT
100+ \$2.45 each
1000+ \$2.25 each
300 bags minimum



INK PRINT
100+ 34¢ each
1000+ 29¢ each
2500+ 24¢ each

Merchandise Die Cut Bags

- Reinforced fold-over handle plus side gusset
- 80 gsm paper

| CODE | SIZE (inches) | CASE PACK | PRICE/EACH |
|----------|---------------|-----------|------------|
| 23081275 | 8 x 2 x 12 | 500 | \$0.40 |
| 23101575 | 10 x 2 x 15 | 500 | \$0.44 |
| 23141875 | 14 x 4 x 18 | 250 | \$0.63 |

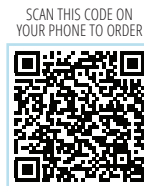

Merchandise Bags

- 110 gsm paper

| CODE | SIZE (in) | CASE | 75 - Kraft PRICE/EACH | 00 - White PRICE/EACH |
|----------|-----------|------|-----------------------|-----------------------|
| 230609__ | 6 x 9 | 2000 | \$0.07 | \$0.09 |
| 230710__ | 7 x 10 | 500 | \$0.09 | \$0.09 |
| 230912__ | 9 x 12 | 500 | \$0.10 | \$0.14 |
| 231114__ | 11 x 14 | 500 | \$0.13 | \$0.18 |
| 231316__ | 13 x 16 | 500 | \$0.19 | \$0.25 |

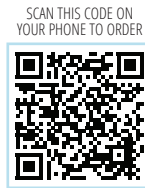

Please allow 2 - 3 weeks for printed items from approved art.



FOIL PRINT
100+ 35¢ each
1000+ 32¢ each
2500+ 26¢ each



DIGITAL PRINT
1-999 62¢ each
1000-2999 40¢ each
3000+ 35¢ each



TRANSFER PRINT
100+ \$2.45 each
1000+ \$2.25 each
300 bags minimum



INK PRINT
100+ 34¢ each
1000+ 29¢ each
2500+ 24¢ each

All print orders subject to set-up charges. Applicable artwork, and plate charges may apply. See page 98.

IN STOCK

Food Service Paper



Tamper Proof Strips
Across Both Sets of Handles



100% Recycled Material

Food Service Kraft Paper Shoppers

- Sturdy and durable
- 110 gsm
- Made from 100% recycled kraft paper

| CODE | DESCRIPTION | SIZE (inches) | CASE PACK | PRICE/EACH | |
|-------------|------------------------------|---------------------|-----------|------------|--------|
| | | | | 250+ | 1000+ |
| A 23121775F | SOS Shopper | 12 x 7 x 17 x 7 | 250 | \$0.27 | \$0.25 |
| B 23141512F | Paper Twist with Tamper Tape | 14 x 10 x 15.5 x 10 | 200 | \$0.86 | \$0.75 |

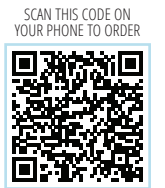

Please allow 2 - 3 weeks for printed items from approved art.



FOIL PRINT
100+ 35¢ each
1000+ 32¢ each
2500+ 26¢ each



DIGITAL PRINT
1-999 62¢ each
1000-2999 40¢ each
3000+ 35¢ each



TRANSFER PRINT
100+ \$2.45 each
1000+ \$2.25 each
300 bags minimum



INK PRINT
100+ 34¢ each
1000+ 29¢ each
2500+ 24¢ each

All print orders subject to set-up charges. Applicable artwork, and plate charges may apply. See page 98.

CREATE YOUR OWN LOOK

BAGS

Natural Jute/Cotton Bags

- 22" long and 1" width natural flat jute cotton handle

| SIZE (inches) | PRICE/EACH | | | |
|---------------|------------|--------|--------|--------|
| | 500+ | 1000+ | 2000+ | 5000+ |
| 16 x 14 x 3 | \$4.67 | \$4.03 | \$3.36 | \$3.00 |



3" Bottom Gusset

Laminated Jute Bags

- 18" long and 1.5" width white cotton flat twill handle

| SIZE (inches) | PRICE/EACH | | | |
|---------------|------------|--------|--------|--------|
| | 500+ | 1000+ | 2000+ | 5000+ |
| 8 x 8 | \$3.48 | \$2.94 | \$2.40 | \$2.05 |

White Cotton Handle



Markin Cotton Canvas Bags

- 24" long and 1" width Markin canvas flat handle

| SIZE (inches) | PRICE/EACH | | | |
|---------------|------------|--------|--------|--------|
| | 500+ | 1000+ | 2000+ | 5000+ |
| 12 x 16 | \$4.25 | \$3.72 | \$3.16 | \$2.88 |



All Canvas

Mix Medium Jute Bags

- 12" long and 1" width Buffalo leather flat handle
- Top trim Joco fabrics in upper and lower portion of body
- Canvas cloth piping in the border of stitching
- Laminated

| SIZE (inches) | PRICE/EACH | | | |
|---------------|------------|---------|---------|--------|
| | 500+ | 1000+ | 2000+ | 5000+ |
| 16 x 18 x 6 | \$13.91 | \$11.71 | \$10.71 | \$9.78 |



Tube Handle Natural Jute Laminated Bags

- 15" Round Tube Handle

| SIZE (inches) | PRICE/EACH | | | |
|---------------|------------|--------|--------|--------|
| | 500+ | 1000+ | 2000+ | 5000+ |
| 8 x 8 | \$6.31 | \$5.33 | \$4.63 | \$4.20 |



Flat Handle Natural Jute Laminated Bags

- 16" long & 1.5" width jute flat handle

| SIZE (inches) | PRICE/EACH | | | |
|---------------|------------|--------|--------|--------|
| | 500+ | 1000+ | 2000+ | 5000+ |
| 12 x 16 | \$6.05 | \$4.98 | \$4.54 | \$4.14 |



CREATE YOUR OWN LOOK

BAGS

IN STOCK

Ultrasonic

BAGS

New



Ultrasonic Bag

- 110 GSM
- PP non woven
- Heat sealed construction - no stitching
- Durable

| CODE | SIZE (inches) | CASE PACK | PRICE/EACH | |
|----------|---------------|-----------|------------|--------|
| | | | 100+ | 1000+ |
| 21091101 | 9 x 5 x 11 | 100 | \$0.62 | \$0.50 |
| 21161401 | 16 x 6 x 14 | 100 | \$0.99 | \$0.79 |

SCAN THIS CODE ON YOUR PHONE TO ORDER



DIGITAL PRINT
 1-999 62¢ each
 1000-2999 40¢ each
 3000+ 35¢ each

Please allow 2 - 3 weeks for printed items from approved art.

IN STOCK

Reusable RPET

BAGS

New



RPET is known as Recycled Polyethylene Terephthalate. It's a strong, durable material constructed from 80% recycled plastic bottles.



00 - White

15 - Black

Smart Bag

- 80 GSM
- RPET material
- Made from reclaimed water bottles
- Small bag made with 7 recycled plastic bottles
- Large bag made with 11 recycled plastic bottles

| CODE | SIZE (inches) | CASE PACK | PRICE/EACH | |
|-----------|-----------------|-----------|------------|--------|
| | | | 100+ | 1000+ |
| 210912 __ | 9 x 5 x 12 x 5 | 100 | \$1.68 | \$1.46 |
| 211614 __ | 16 x 6 x 14 x 6 | 100 | \$1.93 | \$1.64 |



80% Recycled PET

SCAN THIS CODE ON YOUR PHONE TO ORDER



FOIL PRINT - TBD
 100+ 35¢ each
 1000+ 32¢ each
 2500+ 26¢ each



SCREEN PRINT
 100+ \$1.25 each
 500+ \$1.08 each
 1000+ 90¢ each

Please allow 2 - 3 weeks for printed items from approved art.

CREATE YOUR OWN LOOK

Reusable Fabric Style Shoppers

Make a creative impression...
the combinations are endless!

IN STOCK Reusable Shoppers



Full Colour Laminated Bags

- Plates extra per design/side.
Additions for extra charge
- Add matte lamination /bag
 - Add a carded bottom /bag
 - Zipper top /bag
 - Gusset print /bag



Shopping Bags (inches)

- 9 x 4 x 11 x 4
- 11 1/4 x 4 1/4 x 12 x 4 1/4
- 14 x 4 x 16 x 4
- 16 x 6 x 12 x 6
- 16 x 5 x 15 x 5

80 GSM NON-WOVEN
SILK SCREEN PRINT ONE COLOUR 2 SIDES
1"X24" HANDLES - "X" STITCH

100 GSM NON-WOVEN WITH LAMINATION
PRINT 4 COLOUR PROCESS
1"X24" PP WEBBING HANDLES - "X" STITCH



Non-woven Polypropylene

Soft, yet durable. Use this for light to medium weight loads.



Woven Polypropylene

Our strongest material. This rigid weave will handle heavy items.

120 GSM PP WOVEN WITH LAMINATION
PRINT 4 COLOUR PROCESS
1"X24" PP WEBBING HANDLES - "X" STITCH

Many more sizes available - just ask!



Create Your Own Look:
Choose your bag style. Send us your artwork. For 100% full colour design, speak to your sales representative.

- Minimum quantity 2,000 per size
- Estimated lead time: 14 - 16 weeks for printed items from approved art.

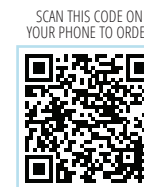

| CODE | DESCRIPTION | SIZE (inches) | CASE PACK | PRICE/EACH | |
|------|--------------------------------------|-------------------------|-----------|------------|--------|
| | | | | 100+ | 1000+ |
| A | 21141615B Black Tote with 4" gusset | 14 x 4 x 16 x 4 | 100 | \$2.25 | \$1.60 |
| B | 21111315BW Six Bottle Wine Tote | 11.5 x 7.25 x 13 x 7.25 | 100 | \$3.17 | \$3.05 |
| C | 21141655B Black Tote with 8" gusset | 14 x 8 x 16 x 8 | 100 | \$2.43 | \$1.77 |
| D | 21141609R Red Tote with 8" gusset | 14 x 8 x 16 x 8 | 100 | \$2.46 | \$1.81 |
| E | 21141675C Large Kraft Composite Tote | 14 x 6 x 16 x 6 | 100 | \$2.58 | - |
| F | 21081075C Small Kraft Composite Tote | 8 x 4 x 10 x 4 | 100 | \$1.72 | - |

FOIL PRINT
100+ 35¢ each
1000+ 32¢ each
2500+ 26¢ each

SCREEN PRINT
100+ \$1.25 each
500+ \$1.08 each
1000+ 90¢ each

TRANSFER PRINT
100+ \$2.45 each
1000+ \$2.25 each
300 bags minimum

Estimated lead time:
2 - 3 weeks for printed items from approved art.

IN STOCK

Non-Woven Garment Covers

Great for resale or promotions!

| CODE | SIZE (inches) | CASE PACK | PRICE/EACH UNPRINTED |
|------------|---------------|-----------|----------------------|
| A 21244015 | 24 x 42 | 100 | \$3.81 |
| B 21245415 | 24 x 54 | 100 | \$5.44 |
| C 21247215 | 24 x 72 + 4 | 100 | \$8.96 |

Silk screen set-up charge: \$75.00

Please allow 2-3 weeks for printed items from approved art.



SCREEN PRINT
 100+ \$1.25 each
 500+ \$1.08 each
 1000+ 90c each

SCAN THIS CODE ON YOUR PHONE TO ORDER



A

Suit Bag 24" x 42"

B

Coat Bags 24" x 54"

C

Gown Bags
 24" x 72" + 4"
 gusset all around

LOOP FOR FOLDING OVER

In Stock
 One roll, white with no print
\$373.75 any size
 21214000S and 21215400S



CREATE YOUR OWN LOOK

Non-Woven Garment Covers

Custom Colours Available

| SIZE | DESCRIPTION |
|-------------|--------------|
| 24 x 42 | Suit Bag |
| 24 x 54 | Coat Bag |
| 24 x 72 + 4 | Gown - Black |

Please allow 14 - 16 weeks from approved art for delivery.
 Minimum 1000 per size.

Pricing includes printing on one side with one colour.

BOXES

GIFT AND APPAREL



IN STOCK

IN STOCK

GIFT AND APPAREL BOXES

Rigid Collapsible Boxes



Ships flat and assembles without the use of peel and stick tape.

- 100% recyclable gift box
- 70% less storage space than rigid box
- Keepsake

| CODE | DESCRIPTION | SIZE (in) | CASE PACK | PRICE/EACH | |
|----------|-------------|--------------------|-----------|------------|--------|
| | | | | 50+ | 500+ |
| 45090800 | Small | 9.25 x 8.5 x 4.25 | 50 | \$4.94 | \$4.35 |
| 45141000 | Medium | 14.5 x 10.5 x 4.25 | 50 | \$6.04 | \$5.41 |
| 45161200 | Large | 16 x 12 x 6.25 | 50 | \$8.47 | \$7.56 |



All 3 sizes fit inside our 3 sizes of Gift Ecomm boxes.

Please allow 3-5 weeks for printed items from approved art.

FOIL PRINT
Exterior and interior lid
40/60/100+ 35¢ each
1000+ 32¢ each
2500+ 26¢ each

DIGITAL PRINT
1-499 62¢ each
500-999 40¢ each
1000+ 35¢ each

INK PRINT
25/50/100+ 34¢ each
1000+ 29¢ each
2500+ 24¢ each



White Foldings

- Our most economical option ships flat and stores flat
- Please allow 2 - 3 weeks for printed items from approved art



Please allow 2 - 3 weeks for printed items from approved art.

FOIL PRINT
50/100+ 35¢ each
1000+ 32¢ each
2500+ 26¢ each

INK PRINT
50/100+ 34¢ each
1000+ 29¢ each
2500+ 24¢ each

| CODE | DESCRIPTION | SIZE (inches) | CASE | PRICE/EACH | |
|----------|-------------|----------------------|-----------------|------------|---------------|
| | | | | 100+ | 1000+ |
| 32058003 | G58 | Baby Mugs | 3.5 x 3.5 x 2 | 100 | \$0.27 \$0.24 |
| 32001003 | G1 | Mugs | 4 x 4 x 4 | 100 | \$0.29 \$0.25 |
| 32002003 | G2 | Cups and Saucers | 6 x 6 x 4 | 100 | \$0.41 \$0.36 |
| 32043003 | G43 | Bowls, etc. | 10 x 8 x 4 | 100 | \$0.55 \$0.51 |
| 32033003 | G33 | Bowls, etc. | 10 x 10 x 6 | 100 | \$1.35 \$1.18 |
| 32005003 | G5 | Teapots, etc. | 8 x 8 x 5 | 100 | \$0.82 \$0.74 |
| 32006003 | G6 | Teapots, etc. | 8 x 8 x 8 | 100 | \$1.21 \$1.09 |
| 32048003 | G48 | Fork, Knife, Spoon | 13 x 4 x 2 | 100 | \$1.45 \$1.31 |
| 32036003 | G36 | Casseroles | 11 x 11 x 4.5 | 100 | \$1.35 \$1.18 |
| 32013003 | G13 | Plates | 5 x 5 x 2 | 100 | \$0.39 \$0.33 |
| 32004003 | G4 | Plates | 8 x 8 x 2 | 100 | \$0.70 \$0.60 |
| 32008003 | G8 | Plates | 11 x 11 x 2 | 100 | \$0.84 \$0.74 |
| 32009003 | G9 | Plates | 13.5 x 13.5 x 2 | 100 | \$1.14 \$1.05 |
| 32040003 | G40 | Plates | 15 x 15 x 2 | 100 | \$1.48 \$1.34 |
| 32003003 | G3 | All purpose | 7 x 4 x 3 | 100 | \$0.49 \$0.44 |
| 32010003 | G10 | All purpose | 9 x 4.5 x 4.5 | 100 | \$0.54 \$0.48 |
| 32038003 | G38 | All purpose | 12 x 4 x 4 | 100 | \$0.68 \$0.62 |
| 32041003 | G41 | All purpose | 10 x 7 x 7 | 100 | \$1.05 \$0.99 |
| 32224003 | G24* | 2-Piece Boxes - Base | 6 x 6 x 10 | 100 | \$0.73 \$0.66 |
| 32124003 | G24* | 2-Piece Boxes - Lid | | 100 | \$0.73 \$0.66 |

* Must be ordered together. Pricing shown is for base and lid combined.



Apparel Boxes

- Minimum order quantity is one case pack
- Please allow 2 - 3 weeks for printed in stock boxes from approved art

IN STOCK COLOURS



SPECIAL ORDER COLOUR

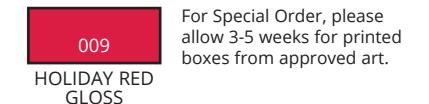

| CODE | DESCRIPTION | CASE SIZE (inches) | PACK | WHITE PRICE /EACH | | KRAFT PINSTRIPE PRICE/EACH | | COLOURS PRICE/EACH | |
|---------|----------------------|--------------------|------|-------------------|--------|----------------------------|--------|--------------------|--------|
| | | | | 100+ | 1000+ | 100+ | 1000+ | 100+ | 1000+ |
| A 32072 | Glove/Sock* | 11.5 x 5.5 x 1.5 | 100 | \$1.51 | \$1.26 | \$1.68 | \$1.40 | — | — |
| B 32073 | Lingerie/T-Shirt | 11.5 x 8.5 x 1.625 | 100 | \$1.70 | \$1.41 | \$1.75 | \$1.46 | \$3.07 | \$2.56 |
| C 32075 | Shirt | 15 x 9.5 x 2 | 100 | \$1.86 | \$1.55 | \$1.98 | \$1.65 | \$4.27 | \$3.56 |
| D 32076 | Sweater/Dress | 17 x 11 x 2.5 | 50 | \$3.15 | \$2.62 | \$3.32 | \$2.76 | \$5.94 | \$4.95 |
| E 32077 | Jacket/Robe | 19 x 12 x 3 | 50 | \$4.19 | \$3.49 | \$3.89 | \$3.37 | \$6.85 | \$5.93 |
| F 32078 | Coat/Gown** | 24 x 14 x 4 | 25 | \$6.68 | \$5.78 | \$7.01 | \$6.07 | \$10.31 | \$8.93 |
| G 32071 | Sweater (white only) | 15 x 11 x 4.5 | 50 | \$5.05 | \$4.37 | — | — | — | — |

FOIL PRINT
25/50/100+ 35¢ each
1000+ 32¢ each
2500+ 26¢ each

INK PRINT
25/50/100+ 34¢ each
1000+ 29¢ each
2500+ 24¢ each

* Kraft pinstripe and White only ** Not available in Black

Please allow 2 - 3 weeks for printed in stock boxes from approved art.

All print orders subject to set-up charges. Applicable artwork, and plate charges may apply. See page 98.

All print orders subject to set-up charges. Applicable artwork, and plate charges may apply. See page 98.

SPECIAL ORDER

Malibu Magnetic Closure Gift Box

Dual purpose - great for gifting and use after.
Perfect for e-commerce business subscriptions.

- Smooth paper covering
- Magnetic closures
- Three colours and three sizes
- Inserts available via special order. Ask your representative



| CODE | DESCRIPTION | SIZE (in) | CASE PACK | PRICE/EACH 40+ |
|-----------|-------------|-----------------------|-----------|----------------|
| 454103 __ | Small | 8.5 x 2.75 x 1.625 | 100 | \$3.78 |
| 454104 __ | Medium | 7.25 x 5.5 x 1.375 | 60 | \$5.18 |
| 454116 __ | Large | 10.75 x 7.125 x 1.625 | 40 | \$6.15 |

Please allow 3-5 weeks for printed items from approved art.



FOIL PRINT
Exterior and interior lid
40/60/100+ 35¢ each
1000+ 32¢ each
2500+ 26¢ each

SCAN THIS CODE ON YOUR PHONE TO ORDER



Tuckit® Folding Gift Boxes

- One piece boxes fold and tuck together for a solid bottom
- 18 sizes available • 100% recycled content (min. 35% post consumer) - kraft excluded



Bottom tucks into place for a secure fit.



| CODE | SIZE (inches) | CASE PACK | ECONO WHITE PRICE/EACH | | KRAFT PRICE/EACH | | GLOSS COLOURS PRICE/EACH | |
|-------------|---------------|-----------|------------------------|--------|------------------|--------|--------------------------|--------|
| | | | 100+ | 1000+ | 100+ | 1000+ | 100+ | 1000+ |
| 334103 __ | 3 x 3 x 2 | 100 | \$0.56 | \$0.51 | \$0.49 | \$0.45 | N/A | N/A |
| 334180 __ | 3 x 3 x 3 | 100 | \$0.49 | \$0.45 | \$0.52 | \$0.47 | N/A | N/A |
| 334111 __ | 4 x 4 x 4 | 100 | \$0.65 | \$0.59 | \$0.64 | \$0.58 | \$1.15 | \$1.05 |
| 334115 __ | 6 x 4.5 x 4.5 | 100 | \$0.95 | \$0.86 | \$0.99 | \$0.90 | \$1.47 | \$1.34 |
| 334113 __ | 6 x 6 x 4 | 100 | \$1.25 | \$1.13 | \$1.25 | \$1.13 | \$2.01 | \$1.83 |
| 334114 __ | 6 x 6 x 6 | 100 | \$1.36 | \$1.23 | \$1.59 | \$1.45 | \$1.93 | \$1.76 |
| 334120 __ | 8 x 8 x 3.5 | 100 | \$2.13 | \$1.93 | \$2.18 | \$1.98 | \$3.06 | \$2.79 |
| 33412100 | 8 x 8 x 6 | 50 | \$3.17 | \$2.64 | N/A | N/A | N/A | N/A |
| 33412200 | 8 x 8 x 8.5 | 100 | \$3.65 | \$3.04 | N/A | N/A | N/A | N/A |
| 334119 __ | 9 x 4.5 x 4.5 | 100 | \$1.31 | \$1.19 | \$1.45 | \$1.32 | \$2.01 | \$1.83 |
| 334183 __ | 10 x 5 x 4 | 100 | \$1.36 | \$1.24 | \$1.23 | \$1.12 | N/A | N/A |
| * 334124 __ | 10 x 10 x 6 | 50 | \$3.77 | \$3.43 | \$4.07 | \$3.70 | \$6.04 | \$5.49 |
| * 334131 __ | 12 x 6 x 6 | 50 | \$2.30 | \$2.09 | \$2.07 | \$1.88 | \$2.63 | \$2.40 |
| * 334125 __ | 12 x 12 x 2.5 | 50 | \$2.65 | \$2.41 | \$3.72 | \$3.39 | \$3.84 | \$3.49 |
| * 334136 __ | 12 x 12 x 5.5 | 50 | \$4.55 | \$4.14 | \$5.07 | \$4.61 | \$3.38 | \$3.08 |
| 334186 __ | 14 x 6 x 6 | 50 | \$3.34 | \$3.04 | \$3.89 | \$3.53 | N/A | N/A |
| 33414500 | 14 x 14 x 5 | 25 | \$5.49 | \$4.99 | N/A | N/A | N/A | N/A |
| 33416700 | 16 x 16 x 7 | 25 | \$7.51 | \$6.83 | N/A | N/A | N/A | N/A |

* not available in Gloss Black

100% recycled content (min. 35% post consumer) - kraft excluded

Please allow 3 - 5 weeks for printed items from approved art.



FOIL PRINT
50/100+ 35¢ each
1000+ 32¢ each
2500+ 26¢ each

SCAN THIS CODE ON YOUR PHONE TO ORDER



E-Commerce BOXES AND MAILER ENVELOPES



All print orders subject to set-up charges. Applicable artwork, and plate charges may apply. See page 98.

All print orders subject to set-up charges. Applicable artwork, and plate charges may apply. See page 98.

CREATE YOUR OWN LOOK

Eco-Friendly, Recyclable
E-Commerce Packaging



Custom E-Commerce Gift Boxes

Go above and beyond to impress customers and exceed their expectations by delivering more than just a product, but also an experience.

- Please allow 12 - 14 weeks for printed items from approved art

SIZE (inches)

| |
|---------------------|
| 10 x 6 x 4 |
| 11.125 x 8.75 x 4 |
| 14.5 x 7.25 x 5 |
| 17 x 12 x 4.25 |
| 17.125 x 11.125 x 2 |

NO PLATE CHARGES!

Custom Poly Mailers

- 2.0 mil co-extruded LDPE film
- White exterior with black interior
- 2" adhesive lip
- Plate charges apply
- Please allow 12 - 14 weeks for printed items from approved art

SIZE (inches)

| |
|-----------------|
| 9 x 12 + 2 |
| 12 x 15 1/2 + 2 |
| 14 1/2 x 19 + 2 |
| 19 x 24 + 2 |

OTHER TYPES OF MAILERS AVAILABLE:

| Product Description | Minimum Qty |
|-----------------------|-------------|
| Recycled Poly Mailers | 25,000+ |
| Padded Paper Mailers | 40,000+ |
| Paper Apparel Mailers | 10,000+ |
| Rigid Paper Mailers | 10,000+ |
| Bubble Poly Mailers | 25,000+ |



50% Recycled Shell
Made in the US

Ask Your Representative For Details On Personalizing Your E-Commerce Mailers

10,000 minimum
1, 2 or 4 colour process. One or both sides



Create Your Own Look:
Choose your box style.
Send us your artwork.
For 100% full colour design, speak to your sales representative.

IN STOCK

Available for immediate shipment.

Deliver the 'in-store' experience to your customer's door.



Gift and Apparel Ecommerce

- Reversible kraft with oyster or black interior
- Sturdy E Flute for safe delivery in 3 sizes
- Pack flat with 50 pieces/carton

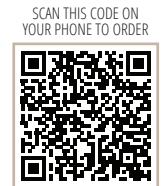

| CODE | SIZE (inches) | CASE | OYSTER/KRAFT PRICE/EACH | | | BLACK/KRAFT PRICE/EACH | | |
|------------|-------------------------|------|-------------------------|--------|--------|------------------------|--------|--------|
| | | | 50+ | 500+ | 1000+ | 50+ | 500+ | 1000+ |
| 451009 ___ | 10.25 x 9.062 x 4.375 | 50 | \$2.34 | \$2.08 | \$1.87 | \$2.77 | \$2.46 | \$2.22 |
| 451511 ___ | 15.562 x 11.062 x 4.562 | 50 | \$3.33 | \$2.81 | \$2.55 | \$3.88 | \$3.28 | \$2.93 |
| 451612 ___ | 16.937 x 12.625 x 6.5 | 50 | \$4.31 | \$3.89 | \$3.45 | \$4.96 | \$4.47 | \$3.96 |

*Kraft and White sides only for Digital Print.
Add a customized In Stock Seal. See page 94.
Add a Special Order Full Colour Seal. See page 96.



DIGITAL PRINT
Only on white and kraft.
1-499 62¢ each
500-999 40¢ each
1000+ 35¢ each



Jewellery Ecommerce For Geo and Horizon packaging.

- Reversible kraft boxes with black or metallic bronze interior
- Black flock inserts available to fit Horizon and Geo jewellery packaging*
- Minimum case pack 25

| CODE | DESCRIPTION | SIZE (inches) | PRICE/EACH | | |
|------------------------|---------------------------|---------------------|------------|--------|--------|
| | | | 25+ | 250+ | 1000+ |
| 450505 ___ | Small Ecom Box | 5.75 x 5.75 x 2.5 | \$1.54 | \$1.46 | \$1.22 |
| 451010 ___ | Large Ecom Box | 10.25 x 10.25 x 2.5 | \$3.08 | \$2.83 | \$2.56 |
| Horizon Inserts | | | | | |
| 69221003H | Ring to fit small box | | \$0.57 | \$0.52 | \$0.38 |
| 69632003H | T-pad to fit small box | | \$0.57 | \$0.52 | \$0.38 |
| 69684003H | Utility to fit small box | | \$0.57 | \$0.52 | \$0.38 |
| 69693003H | Bracelet to fit large box | | \$0.93 | \$0.74 | \$0.66 |
| Geo Inserts | | | | | |
| 69221153G | Ring to fit small box | | \$0.57 | \$0.52 | \$0.38 |
| 69283153G | T-pad to fit small box | | \$0.57 | \$0.52 | \$0.38 |
| 69293153G | Bracelet to fit large box | | \$0.93 | \$0.74 | \$0.66 |
| 69273153G | Necklace to fit large box | | \$0.93 | \$0.74 | \$0.66 |

Add a customized In Stock Seal. See page 94.
Add a Special Order Full Colour Seal. See page 96.

All print orders subject to set-up charges. Applicable artwork, and plate charges may apply. See page 98.

IN STOCK

Recyclable Ecommerce Mailer

- Natural brown kraft paper
- 150 gsm recycled paper - 40% PCW
- Strong and flexible with 3" gussets
- 1 sku - customizable to sizes



| CODE | SIZE (inches) | CASE PACK | PRICE/EACH | |
|----------|------------------|-----------|------------|--------|
| | | | 200+ | 1000+ |
| 52524512 | 20.5 x 3 x 17.75 | 200 | \$1.03 | \$0.91 |

| FOIL PRINT | | |
|------------|----------|--|
| 200+ | 35c each | |
| 1000+ | 32c each | |
| 2500+ | 26c each | |

Eco-Friendly – “Be Proud of the Way You Ship”



A Recycled Poly Mailers

| - IN STOCK - | | | | |
|--------------|-----------|------|------------|--------|
| CODE | SIZE (in) | CASE | PRICE/EACH | |
| | | | 1+ | 4+ |
| 52091286 | 9 x 12 | 1000 | \$0.57 | \$0.54 |
| 52101386 | 10 x 13 | 1000 | \$0.60 | \$0.57 |
| 52121586 | 12 x 15.5 | 500 | \$0.79 | \$0.75 |

| - SPECIAL ORDER - | | | | |
|-------------------|------------|------|------------|--------|
| CODE | SIZE (in) | CASE | PRICE/EACH | |
| | | | 1+ | 4+ |
| 52060986 | 6 x 9 | 1000 | \$0.41 | \$0.39 |
| 52071086 | 7.5 x 10.5 | 1000 | \$0.48 | \$0.45 |
| 52141986 | 14.5 x 19 | 250 | \$1.33 | \$1.26 |
| 52192486 | 19 x 24 | 125 | \$2.16 | \$2.04 |
| 52242486 | 24 x 24 | 125 | \$2.92 | \$2.77 |

B Padded Paper Mailers

| - IN STOCK - | | | | |
|--------------|-----------|------|------------|--------|
| CODE | SIZE (in) | CASE | PRICE/EACH | |
| | | | 1+ | 4+ |
| 52060976 | 6 x 9 | 250 | \$0.87 | \$0.83 |
| 52081176 | 8.5 x 11 | 100 | \$1.38 | \$1.31 |

| - SPECIAL ORDER - | | | | |
|-------------------|-----------|-------|------------|--------|
| CODE | SIZE (in) | CASE | PRICE/EACH | |
| | | | 1+ | 4+ |
| 52101576 | 10.5 x 15 | 2 100 | \$2.04 | \$1.93 |

C Paper Apparel Mailers

| - IN STOCK - | | | | |
|--------------|---------------|------|------------|--------|
| CODE | SIZE (in) | CASE | PRICE/EACH | |
| | | | 1+ | 4+ |
| 52101375 | 10 x 13 | 250 | \$1.46 | \$1.39 |
| 52121575 | 12 x 15.5 | 150 | \$1.96 | \$1.85 |
| 52101975 | 10.5 x 4 x 19 | 100 | \$2.32 | \$2.20 |

| - SPECIAL ORDER - | | | | |
|-------------------|-----------|------|------------|--------|
| CODE | SIZE (in) | CASE | PRICE/EACH | |
| | | | 1+ | 4+ |
| 52070975 | 7 x 9 | 250 | \$0.95 | \$0.90 |

D Rigid Paper Mailers

| - IN STOCK - | | | | |
|--------------|--------------|------|------------|--------|
| CODE | SIZE (in) | CASE | PRICE/EACH | |
| | | | 1+ | 4+ |
| 52061012 | 6 x 10 | 500 | \$0.68 | \$0.65 |
| 52061212 | 6 x 2.5 x 12 | 500 | \$0.98 | \$0.93 |
| 52091412 | 9.5 x 14.5 | 250 | \$1.19 | \$1.12 |

| - SPECIAL ORDER - | | | | |
|-------------------|-----------|------|------------|--------|
| CODE | SIZE (in) | CASE | PRICE/EACH | |
| | | | 1+ | 4+ |
| 52081212 | 8.5 x 12 | 250 | \$0.90 | \$0.85 |
| 52101612 | 10.5 x 16 | 250 | \$1.43 | \$1.35 |
| 52121912 | 12.5 x 19 | 250 | \$1.62 | \$1.53 |

For more product information on recyclability and material content, visit gunthermele.com

E Bubble Poly Mailers

| - SPECIAL ORDER - NO PRINT | | | | |
|----------------------------|-------------|------|------------|--------|
| CODE | SIZE (in) | CASE | PRICE/EACH | |
| | | | 1+ | 4+ |
| 52040600 | 4 x 6.75 | 500 | \$0.63 | \$0.59 |
| 52060800 | 6.5 x 8.75 | 250 | \$0.71 | \$0.67 |
| 52081000 | 8.5 x 10.75 | 100 | \$1.06 | \$1.01 |

Custom printing available. Minimum 25,000 quantities.



| FOIL PRINT | | |
|------------|----------|--|
| 100+ | 35c each | |
| 1000+ | 32c each | |
| 2500+ | 26c each | |

| PAD PRINT | | |
|-----------|----------|--|
| 100+ | 35c each | |
| 1000+ | 32c each | |
| 2500+ | 26c each | |

| INK PRINT | | |
|-----------|----------|--|
| 100+ | 34c each | |
| 1000+ | 29c each | |
| 2500+ | 24c each | |



All print orders subject to set-up charges. Applicable artwork, and plate charges may apply. See page 98.

FINISHING TOUCHES

RIBBON, TISSUE, WRAP AND SEALS



All print orders subject to set-up charges. Applicable artwork, and plate charges may apply. See page 98.

IN STOCK

Inspirations Gift Wrap

Inspirations
Giftwrap

By Gunther Mele

Available for immediate shipment.



Inspirations
Giftwrap

By Gunther Mele

Available for immediate shipment.

IN STOCK

Inspirations Gift Wrap



GIFT WRAP

GIFT WRAP

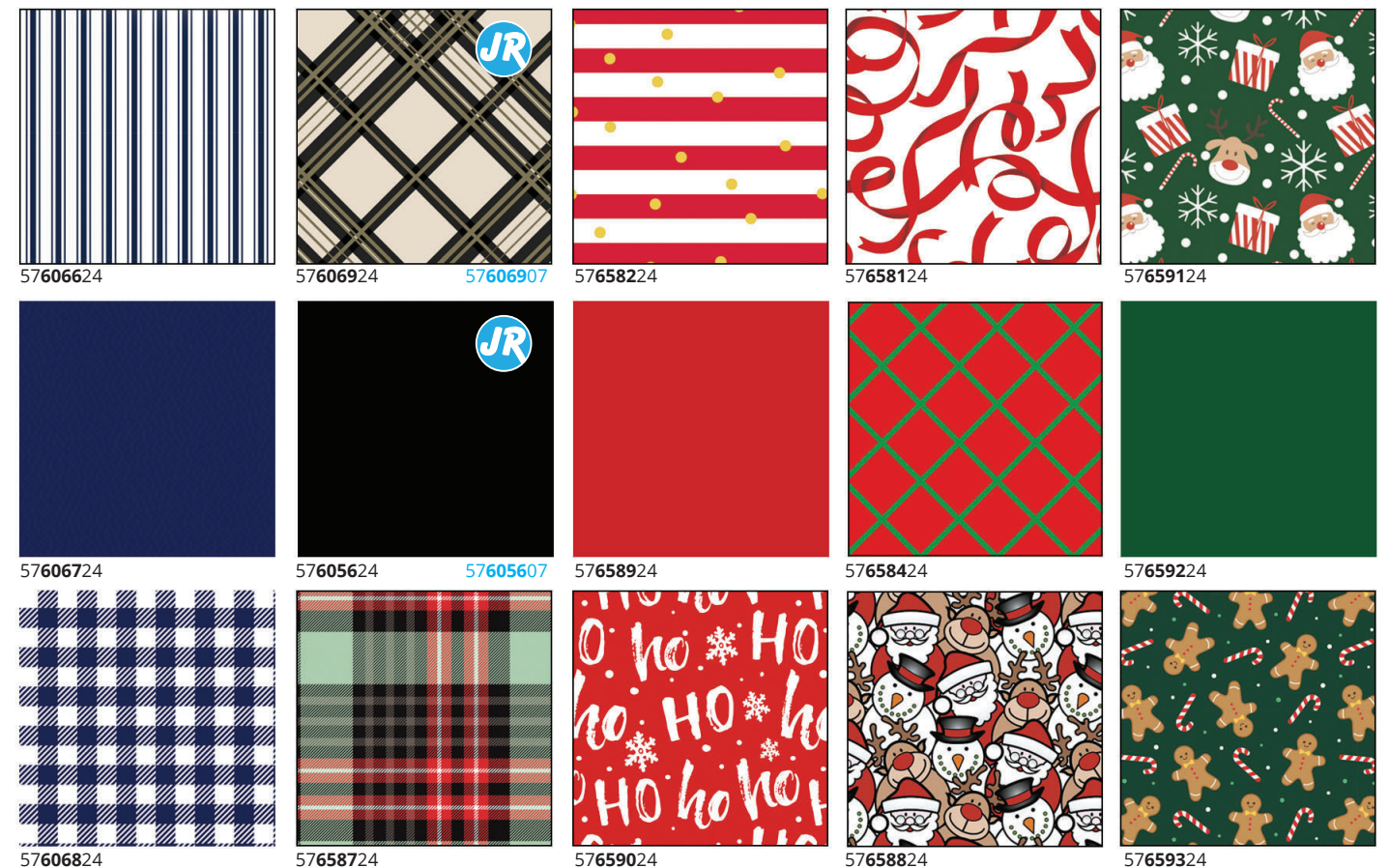
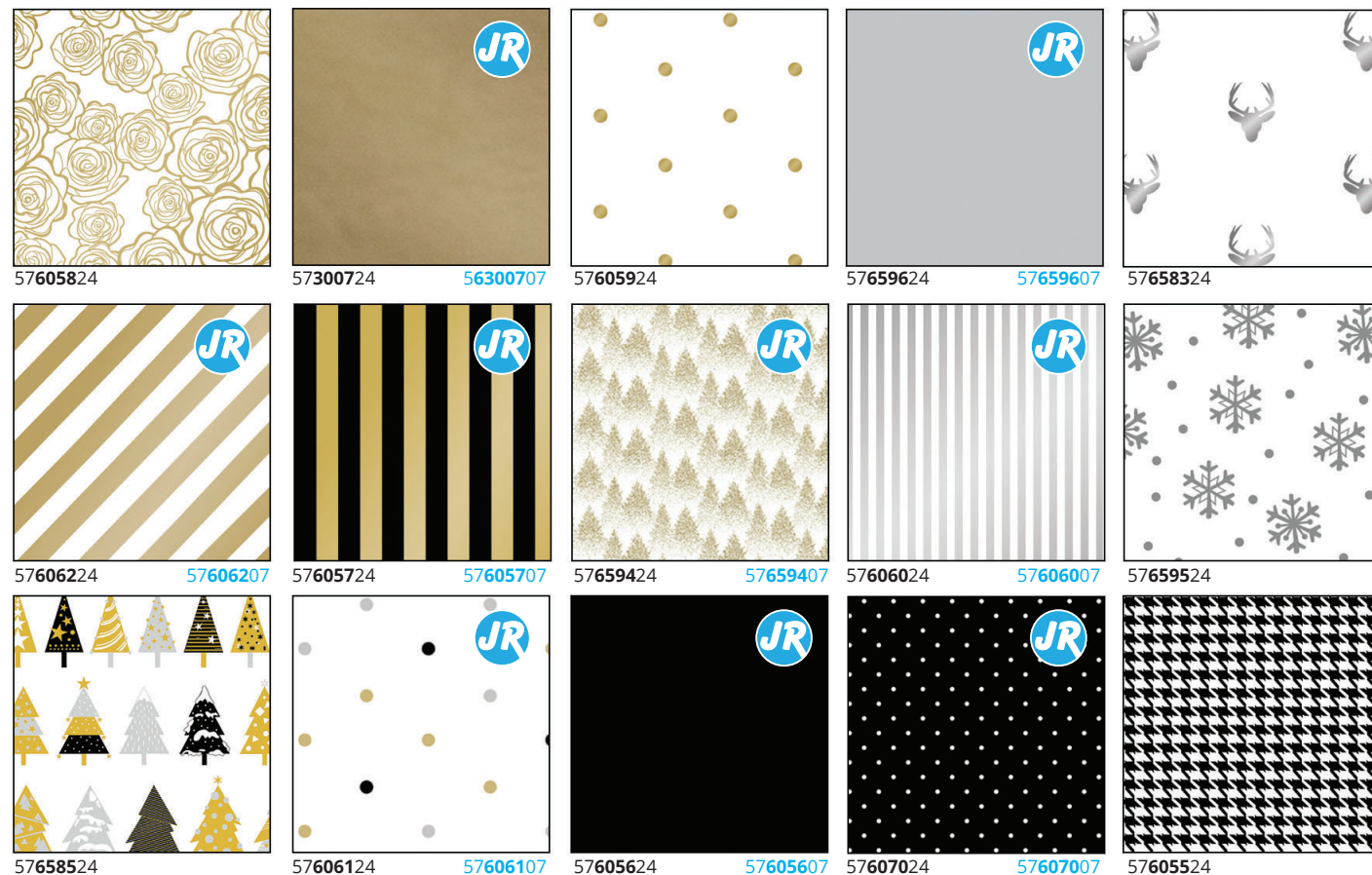

24" x 417' - 1/2 Ream Roll
\$109.07 Code # 57 ____ 24
each

8" x 150' - Jewellers Rolls **\$44.52** Code # 57 ____ 07
each



24" x 417' - 1/2 Ream Roll
\$109.07 Code # 57 ____ 24
each

8" x 150' - Jewellers Rolls **\$44.52** Code # 57 ____ 07
each

CREATE YOUR OWN LOOK

• Please allow 6 - 8 weeks for printed items from approved art.



Printed Tissue: Pick a PMS print colour and we will match it.

– See page 87 for Special Order Tissue Colours!

| CODE | DESCRIPTION | SIZE (in) | PACKAGED | PRICE/EACH | |
|------------|--------------|-----------|----------|------------|----------|
| | | | | 10 REAMS | 30 REAMS |
| 20869000G | White | 20 X 30 | 480 | \$119.46 | \$103.36 |
| 20869000M | Coloured | 20 x 30 | 480 | \$171.24 | \$148.17 |
| 20869000GK | Kraft | 20 x 30 | 480 | \$119.46 | \$103.36 |
| 20869001M | Metallic SS* | 20 x 30 | 200 | \$283.39 | \$268.74 |

* SS - single sided

Print included in price of tissue.

Minimum 10 reams. Note: Plates extra \$310.00 (per colour).
Ships in approximately 6 - 8 weeks.

For metallic ink print: add 10% to the price above.
For > 50% ink coverage, an additional \$10 per ream.
All custom orders subject to a +/-10% over/under run.

Custom Printed
White Tissue – 10 Reams
\$1194.60

IN STOCK

Available for immediate shipment.

Spotlight Tissue Colours

| CODE | DESCRIPTION | SIZE (in) | PKG | PRICE/EACH | | |
|-----------|-------------------------------|-------------|--------|---------------|---------|---------|
| | | | | 1 - 4 | 5+ | 25+ |
| 20819290S | White Economy | 19 x 29 | 480 | \$21.81 | \$18.70 | \$15.58 |
| 208551_G | Spotlight on Value (colours) | 20 x 30 | 480 | \$41.72 | \$39.74 | \$39.74 |
| 208559_G | Spotlight on Value (metallic) | 20 x 30 | 200 | \$75.13 | \$73.73 | \$72.34 |
| 20850102 | #1 White Economy | 19 x 14.5 | 480 | \$10.00 | \$8.75 | \$7.19 |
| 20851800 | #1 White Bleached | 18 x 9 dia. | 1 roll | \$124.66/roll | | |
| 20852000 | #1 White Bleached | 20 x 9 dia. | 1 roll | \$154.26/roll | | |

10 in stock tissue colours to choose from.
Plus check out our assorted Pre-Pack!

SCAN THIS CODE ON YOUR PHONE TO ORDER



| | | | | | | |
|--------------|--|----------------|----------------|------------|-------------|---------|
| 14 DANDELION | 16 ORANGE | 19 BRIGHT LIME | 56 ZIPPY GRAPE | 60 EMERALD | 21 HOT PINK | 07 GOLD |
| 66 BURGUNDY | * Hot Pink (21) and Burgundy (66) are \$55.23/each | | | | 08 SILVER | |

SPECIAL ORDER

Unprinted Tissue

Unprinted, minimum 1 ream (per colour).
Ships in approximately 4 - 6 weeks.

| CODE | DESCRIPTION | SIZE (in) | Packaged | PRICE/REAM | |
|----------|-----------------------|-----------|------------|------------|-----------|
| | | | | 1 REAM | 25+ REAMS |
| 20899_-- | Special Order Colours | 20 x 30 | 480 sheets | \$56.27 | \$49.36 |

| | | | | | | | | | | |
|-----------------------|----------------------|----------------------|---------------------|----------------------|-----------------------|----------------------|---------------------|----------------------|------------------|--------------------|
| NE-100 LIGHT PINK | NE-110 PINK | NE-120 CORAL ROSE | NE-124 AZALEA | NE-126 SCARLET | NE-130 RED | NE-131 DEEP SCARLET | NE-145 FUCHSIA | NE-148 HOT PINK | NE-150 CERISE | NE-155 ZIPPY GRAPE |
| NE-160 PURPLE | NE-164 SANDSTONE | NE-165 BURGUNDY | NE-170 DUBONNET | NE-190 PEACH | NE-195 TANGERINE | NE-200 ORANGE | NE-210 LIGHT YELLOW | NE-220 YELLOW | NE-222 DANDELION | NE-223 OATMEAL |
| NE-226 POPPY | NE-230 GOLDENROD | NE-235 PISTACHIO | NE-246 EMERALD | NE-247 JADE | NE-245 PALE MINT | NE-250 MID GREEN | NE-251 GROOVY GREEN | NE-255 BRIGHT LIME | NE-265 TEAL | NE-266 BALSAM |
| NE-269 OASIS GREEN | NE-270 DARK GREEN | NE-273 FESTIVE GREEN | NE-274 CEDAR GREEN | NE-275 FOREST GREEN | NE-277 TAPESTRY GREEN | NE-278 AZURE | NE-279 OXFORD BLUE | NE-281 BLUE BREEZE | NE-300 TURQUOISE | NE-305 CERULEAN |
| NE-306 BRILLIANT BLUE | NE-308 SAPPHIRE | NE-310 DARK BLUE | NE-325 LILAC | NE-330 LAVENDER | NE-335 PERIWINKLE | NE-338 LILAC PERFUME | NE-340 PLUM | NE-341 RASPBERRY FIZ | NE-345 CRANBERRY | NE-347 CRÈME |
| NE-350 FRENCH VANILLA | NE-354 SHADOW GREY | NE-356 GRANITE | NE-357 NOBLE GOLD | NE-359 ESPRESSO | NE-360 DESERT TAN | NE-361 BERMUDA SAND | NE-362 TERRA COTTA | NE-366 BURNT SIENNA | NE-370 CHOCOLATE | NE-371 RAW SIENNA |
| NE-375 ANTIQUE BLUE | NE-382 COLONIAL BLUE | NE-385 NAVY BLUE | NE-386 MORNING MIST | NE-389 MOUNTAIN MIST | NE-390 GRAY | NE-400 BLACK | NE-410 BIRCH | NE-415 DUNE BEIGE | NE-417 PARCHMENT | |

IN STOCK

Available for immediate shipment.

Curling Ribbon

See chart for available colours

| CODE | PRICE/ROLL |
|--|------------|
| COLOURS - 3/16" x 500 yards 148373 __ | \$4.76 |
| METALLIC - 3/16" x 250 yards 148378 __ | \$12.88 |



2.75" Star Bows

See chart for available colours

| CODE | CASE PACK | PRICE/EACH | 1000+ |
|---|-----------|------------|--------|
| COLOURS - 2.75" x 17 loop 142311 __ | 200 | \$0.20 | \$0.18 |
| METALLIC - 2.5" x 17 loop 14531107 Gold | 200 | \$0.20 | \$0.18 |
| 14531108 Silver | 200 | \$0.20 | \$0.18 |

Min: case pack



3.75" Star Bows

See chart for available colours

| CODE | CASE PACK | PRICE/EACH | 1000+ |
|--|-----------|------------|--------|
| COLOURS - 3.75" x 13 loop 143512 __ | 200 | \$0.21 | \$0.19 |
| METALLIC - 3.75" x 17 loop 14551207 Gold | 200 | \$0.30 | \$0.28 |
| 14551208 Silver | 200 | \$0.30 | \$0.28 |

Min: case pack

Splendor Ribbon

See chart for available colours

| CODE | PRICE/ROLL |
|---|------------|
| COLOURS - 3/4" x 250 yards 141050 __ | \$13.087 |
| METALLIC - 3/4" x 100 yards 14013007 Gold | \$17.43 |
| 14013008 Silver | \$17.43 |



99 - Everyday Assortment Star Bows Available in 2.75" and 3.75"



98 - Christmas Assortment Star Bows Available in 2.75" and 3.75"



Metallic Star Bows Available in 2.75" and 3.75"



RIBBONS

BOWS

IN STOCK

Available for immediate shipment.

Perfect Bows™

Minimum: 50 per size, per colour.

| CODE | SIZE | PRICE/EACH | |
|-----------|------------------|------------|--------|
| | | 50+ | 1000+ |
| 140515 __ | 5.5" Perfect Bow | \$1.62 | \$1.46 |



Pull Bows

Minimum: 100 per size, per colour.

| CODE | SIZE | STANDARD COLOURS | | METALLIC COLOURS | |
|-----------|----------------|------------------|--------|------------------|--------|
| | | 100+ | 1000+ | 100+ | 1000+ |
| 132000 __ | Petite 2" Bows | \$0.31 | \$0.27 | \$0.43 | \$0.39 |
| 134000 __ | Std. 4" Bows | \$0.52 | \$0.47 | \$0.73 | \$0.67 |



Mini Metallic Star Bows

252 per pack

| CODE | DESCRIPTION | PRICE/PACK |
|----------|-------------|------------|
| 14121099 | Assorted | \$41.58 |
| 14121017 | Gold | \$41.58 |
| 14121008 | Silver | \$41.58 |



Matte Wraphia™

| CODE | SIZE | PRICE/ROLL |
|-----------|---------|------------|
| 148367 __ | 100 yds | \$10.73 |

Paper Roll/Ream Dispenser and Tape

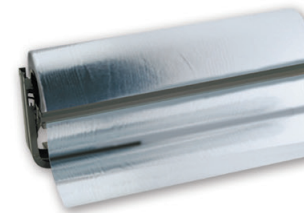

| CODE | DESCRIPTION | PRICE/EA |
|----------|---|----------|
| 09850124 | Paper Roll/Ream Roll dispenser - 24" rack | \$84.04 |

SCAN THIS CODE ON YOUR PHONE TO ORDER



Ribbon Shredder

CODE: 09878600
PRICE: \$9.04 each

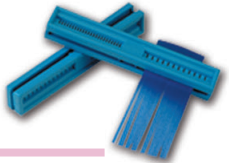

Curling Ribbon Roll Dispenser

CODE: 09850100
PRICE: \$136.35 each



Holds 12 Rolls

Cellophane (1.0mil)

| CODE | DESCRIPTION | SIZE | PRICE/ROLL |
|----------|------------------|------------|------------|
| 16400506 | Clear Cellophane | 40" x 100' | \$21.67 |



SCAN THIS CODE ON YOUR PHONE TO ORDER



| Color # Name | Curling Ribbon | 2.75" Star Bows | 3.75" Star Bows | Splendor Ribbon |
|----------------------|----------------|-----------------|-----------------|-----------------|
| 00 - White | | | | |
| 86 - Ivory | | | | |
| 29 - Vanilla | | | | |
| 61 - Pastel Yellow | | | | |
| 03 - Yellow | | | | |
| 13 - Daffodil | | | | |
| 14 - Sunshine Yellow | | | | |
| 07 - Gold | | | | |
| 08 - Silver | | | | |
| 27 - Holiday Gold | | | | |
| 22 - Melon | | | | |
| 73 - Coral | | | | |
| 16 - Tropical Orange | | | | |
| 17 - Orange | | | | |
| 12 - Chocolate | | | | |
| 75 - Baby Pink | | | | |
| 01 - Pink | | | | |
| 57 - Azalea | | | | |
| 09 - Hot Red | | | | |
| 58 - Lava Red | | | | |
| 66 - Burgundy | | | | |
| 41 - Beauty | | | | |
| 59 - Dubonnet Rose | | | | |
| 28 - Orchid | | | | |
| 05 - Lavender | | | | |
| 56 - Purple | | | | |
| 54 - Periwinkle | | | | |

| Color # Name | Curling Ribbon | 2.75" Star Bows | 3.75" Star Bows | Splendor Ribbon |
|---------------------------|----------------|-----------------|-----------------|-----------------|
| 50 - Plum | | | | |
| 11 - Royal | | | | |
| 81 - Navy | | | | |
| 77 - Baby Blue | | | | |
| 02 - Light Blue | | | | |
| 47 - Aqua | | | | |
| 32 - Caribbean Blue | | | | |
| 55 - Robin's Egg | | | | |
| 25 - Turquoise | | | | |
| 71 - Sea Green | | | | |
| 18 - Celery | | | | |
| 74 - Spruce | | | | |
| 60 - Hunter | | | | |
| 84 - Teal | | | | |
| 04 - Mint | | | | |
| 19 - Citrus | | | | |
| 96 - Leaf | | | | |
| 30 - Celadon | | | | |
| 10 - Emerald | | | | |
| 70 - Antique Silver | | | | |
| 15 - Black | | | | |
| 07 - Metallic Gold | | | | |
| 08 - Metallic Silver | | | | |
| 09 - Metallic Red | | | | |
| 10 - Metallic Green | | | | |
| 99 - Everyday Assortment | N/A | | | N/A |
| 98 - Christmas Assortment | N/A | | | N/A |

SPECIAL ORDER

RIBBON

Unprinted Satin and Grosgrain Ribbon

See chart to the right for ribbon colours.



Single Face Satin

| WIDTH | CODE | PRICE/EA |
|---------------------|-----------|----------|
| 3/8" x 100 yd roll | 14031 ___ | \$23.94 |
| 5/8" x 100 yd roll | 14032 ___ | \$25.68 |
| 7/8" x 100 yd roll | 14033 ___ | \$42.43 |
| 1-1/2" x 50 yd roll | 14034 ___ | \$31.82 |

Grosgrain

| WIDTH | CODE | PRICE/EA |
|---------------------|-----------|----------|
| 3/8" x 100 yd roll | 14160 ___ | \$23.68 |
| 5/8" x 100 yd roll | 14161 ___ | \$28.70 |
| 7/8" x 100 yd roll | 14162 ___ | \$42.38 |
| 1-1/2" x 50 yd roll | 14170 ___ | \$27.53 |

1 roll minimum.

Lead time please allow 4-6 weeks for shipment. SPECIAL ORDER

Printed Satin Ribbon

Enquire about our new selection of ribbon colors from your sales representative.



Single Face Satin

| WIDTH | CODE | PRICE/EA |
|----------------------|----------|----------|
| 3/8" x 100 yd roll | 14150002 | \$47.56 |
| 5/8" x 100 yd roll | 14150003 | \$50.88 |
| 7/8" x 100 yd roll | 14150005 | \$59.21 |
| 1-1/2" x 100 yd roll | 14150015 | \$95.11 |

(2 x 50 yd rolls)

500 yard minimum per width. Note: Plates extra \$94.00 (per colour).

Foil Print Colours

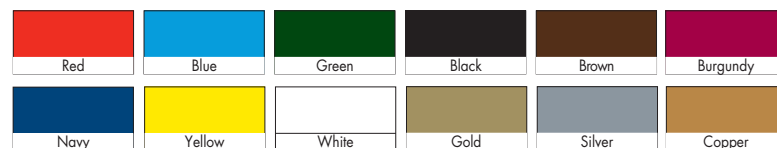

Contact your sales representative.



FOIL PRINT
Included in price of ribbon

Please allow 3-4 weeks for printed items from approved art.

All print orders subject to set-up charges. Applicable artwork, and plate charges may apply. See page 98.

SPECIAL ORDER

While we strive for accuracy in our catalogue, actual product may be slightly different than pictured.

Please allow 3-4 weeks for printed items from approved art.

RIBBON

| 3/8" | | 5/8" | | 7/8" | | 1-1/2" | | COLOUR NUMBER AND NAME | 3/8" | | 5/8" | | 7/8" | | 1-1/2" | | COLOUR NUMBER AND NAME |
|-------------------|-----------|-------------------|-----------|-------------------|-----------|-------------------|-----------|------------------------|-------------------|-----------|-------------------|-----------|-------------------|-----------|-------------------|-----------|------------------------|
| Single Face Satin | Grosgrain | Single Face Satin | Grosgrain | Single Face Satin | Grosgrain | Single Face Satin | Grosgrain | | Single Face Satin | Grosgrain | Single Face Satin | Grosgrain | Single Face Satin | Grosgrain | Single Face Satin | Grosgrain | |
| | | | | | | | | 029 - White | | | | | | | | | 462 - Royal Orchid |
| | | | | | | | | 007 - Shell Grey | | | | | | | | | 464 - Delphinium |
| | | | | | | | | 012 - Silver | | | | | | | | | 465 - Purple |
| | | | | | | | | 015 - Grey | | | | | | | | | 470 - Regal Purple |
| | | | | | | | | 022 - Pewter | | | | | | | | | 473 - Amethyst |
| | | | | | | | | 028 - Antique White | | | | | | | | | 528 - Lemon Grass |
| | | | | | | | | 813 - Oyster | | | | | | | | | 530 - Mint |
| | | | | | | | | 016 - Portobello | | | | | | | | | 533 - Jungle Green |
| | | | | | | | | 030 - Black | | | | | | | | | 547 - New Chartreuse |
| | | | | | | | | 115 - Powder Pink | | | | | | | | | 548 - Kiwi |
| | | | | | | | | 117 - Light Pink | | | | | | | | | 550 - Apple Green |
| | | | | | | | | 150 - Pink | | | | | | | | | 558 - Leaf |
| | | | | | | | | 156 - Hot Pink | | | | | | | | | 567 - Spring Moss |
| | | | | | | | | 175 - Shocking Pink | | | | | | | | | 570 - Moss |
| | | | | | | | | 187 - Azalea | | | | | | | | | 580 - Emerald |
| | | | | | | | | 241 - Living Coral | | | | | | | | | 586 - New Neon Green |
| | | | | | | | | 250 - Red | | | | | | | | | 587 - Forest Green |
| | | | | | | | | 252 - Hot Red | | | | | | | | | 617 - Baby Maize |
| | | | | | | | | 260 - Scarlet | | | | | | | | | 640 - Lemon |
| | | | | | | | | 275 - Wine | | | | | | | | | 645 - Daffodil |
| | | | | | | | | 277 - Burgundy | | | | | | | | | 650 - Maize |
| | | | | | | | | 285 - Plum | | | | | | | | | 660 - Yellow Gold |
| | | | | | | | | 305 - Light Blue | | | | | | | | | 675 - Gold |
| | | | | | | | | 331 - Dusty Blue | | | | | | | | | 690 - Old Gold |
| | | | | | | | | 312 - Blue | | | | | | | | | 722 - Burnt Sienna |
| | | | | | | | | 315 - Navajo Turquoise | | | | | | | | | 743 - Ginger |
| | | | | | | | | 329 - Cobalt | | | | | | | | | 750 - Torrid Orange |
| | | | | | | | | 340 - Turquoise | | | | | | | | | 789 - Sherry |
| | | | | | | | | 343 - Tornado Blue | | | | | | | | | 790 - Currant |
| | | | | | | | | 350 - Royal | | | | | | | | | 810 - Ivory |
| | | | | | | | | 352 - Electric Blue | | | | | | | | | 815 - Cream |
| | | | | | | | | 353 - Century Blue | | | | | | | | | 825 - Natural |
| | | | | | | | | 365 - Light Navy | | | | | | | | | 835 - Tan |
| | | | | | | | | 370 - Navy | | | | | | | | | 841 - Khaki |
| | | | | | | | | 412 - Purple Haze | | | | | | | | | 850 - Brown |
| | | | | | | | | 430 - Light Orchid | | | | | | | | | 866 - Coffee |
| | | | | | | | | 450 - Orchid | | | | | | | | | |

IN STOCK

In stock and ready to ship.

Simply Sheer Asiana Ribbon

Monofilament-Edge



| CODE | SIZE | PRICE/ROLL |
|-----------|--------------------|------------|
| 149435 __ | 7/8" x 100 yards | \$16.82 |
| 149436 __ | 1 1/2" x 100 yards | \$18.56 |

• minimum order: one roll.



Can be special ordered in additional colours!

SCAN THIS CODE ON YOUR PHONE TO ORDER



SPECIAL ORDER

Please allow 4 - 6 weeks for shipment.

Contessa Ribbon

Wire-Edge
Single Face Satin



| CODE | SIZE | PRICE/ROLL |
|-----------|-------------------|------------|
| 14163 __ | 1 1/2" x 25 yards | \$18.05 |
| *14164 __ | 2 1/4" x 25 yards | \$27.08 |

• minimum order: one roll.



* 2-1/4" is only available in 029-White, 260-Scarlet and 810-Ivory.

SCAN THIS CODE ON YOUR PHONE TO ORDER



Encore Ribbon

Wire-Edge



| CODE | SIZE | PRICE/ROLL |
|-----------|-------------------|------------|
| 141650 __ | 5/8" x 25 yards | \$8.49 |
| 141660 __ | 1 1/2" x 25 yards | \$16.20 |
| 141670 __ | 2 1/2" x 25 yards | \$24.65 |

• minimum order: one roll.



* not available in 5/8"
† not available in 2 1/2"

SCAN THIS CODE ON YOUR PHONE TO ORDER



Please allow 4 - 6 weeks
for printed items from
approved art.

CREATE YOUR OWN LOOK

Raised Ink Printing

See chart below for ribbon colours.

Pick your own colours for raised print - NO PLATE CHARGE

Available in: 5/8" x 100 yd roll, 7/8" x 100 yd roll, 1-1/2" x 50 yd roll
40 roll minimum for all printed ribbon.

Sheer Ribbon Colours All colours are available in all sizes. See page 90-91 for single face satin and grosgrain colour availability.



Single Face Satin Ribbon with Raised Print



Sheer Ribbon with Raised Print



Grosgrain Ribbon with Raised Print

IN STOCK

IN STOCK

SEALS

SEALS



Customized Seals-Foil Printed

| CODE | One colour foil print/each SIZE | SPECIAL ORDER Two colour/each | | SPECIAL ORDER Acetate 1 colour/each | | SPECIAL ORDER Acetate 2 colour/each | | | |
|--|------------------------------------|----------------------------------|--------|--|----------|--|----------|----------|----------|
| | | 2000+ | 5000+ | 2000+ | 5000+ | 2000+ | 5000+ | | |
| 25 4 digit label code 2 digit label colour | A | \$0.12 | \$0.10 | \$0.1577 | \$0.1242 | \$0.1792 | \$0.1393 | \$0.2062 | \$0.1598 |
| | B | \$0.13 | \$0.12 | \$0.1685 | \$0.1307 | \$0.2149 | \$0.1685 | \$0.2473 | \$0.1976 |
| | C | \$0.15 | \$0.14 | \$0.1803 | \$0.1501 | \$0.2750 | \$0.1977 | \$0.2894 | \$0.2354 |
| | D* | \$0.17 | \$0.15 | \$0.1922 | \$0.1598 | \$0.3175 | \$0.2538 | \$0.3424 | \$0.2743 |

\$80 plate charge

NO PLATE CHARGES

Label Colours Available:

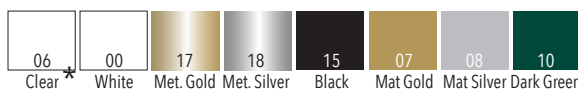

* D sized Seals and Clear print are SPECIAL ORDER.
See foil chart on inside back cover of catalogue for available print colours.



FOIL PRINT
Included in the price.
Please allow 2-3 weeks for printing.

Pre-printed Labels

Available for immediate shipment.



| CODE | SIZE | CASE | PRICE/EACH | |
|-----------|------------|------|------------|--------|
| | | | 1000+ | 5000+ |
| 25401007S | 5/8 x 3/8" | 1000 | \$0.13 | \$0.12 |
| 25401407S | 5/8 x 3/8" | 1000 | \$0.13 | \$0.12 |
| 25406208S | 5/8 x 3/8" | 1000 | \$0.13 | \$0.12 |
| 25401007V | 3/4" oval | 1000 | \$0.13 | \$0.12 |
| 25401407V | 3/4" oval | 1000 | \$0.13 | \$0.12 |
| 25406008V | 3/4" oval | 1000 | \$0.13 | \$0.12 |

1000/box minimum order - 1 box of 1000.



For a no-print solution, order our in stock embossed seals.

Embossed Seals

Available for immediate shipment.

| 500/box min. order - 1 box. | CODE | SIZE | PRICE/EA |
|-----------------------------|-----------------|-----------|----------|
| | Gold 08701207 | 1.5" dia. | \$0.09 |
| | Silver 08701208 | 1.5" dia. | \$0.09 |

ACTUAL EMBOSSED PATTERN 1.5" DIA.

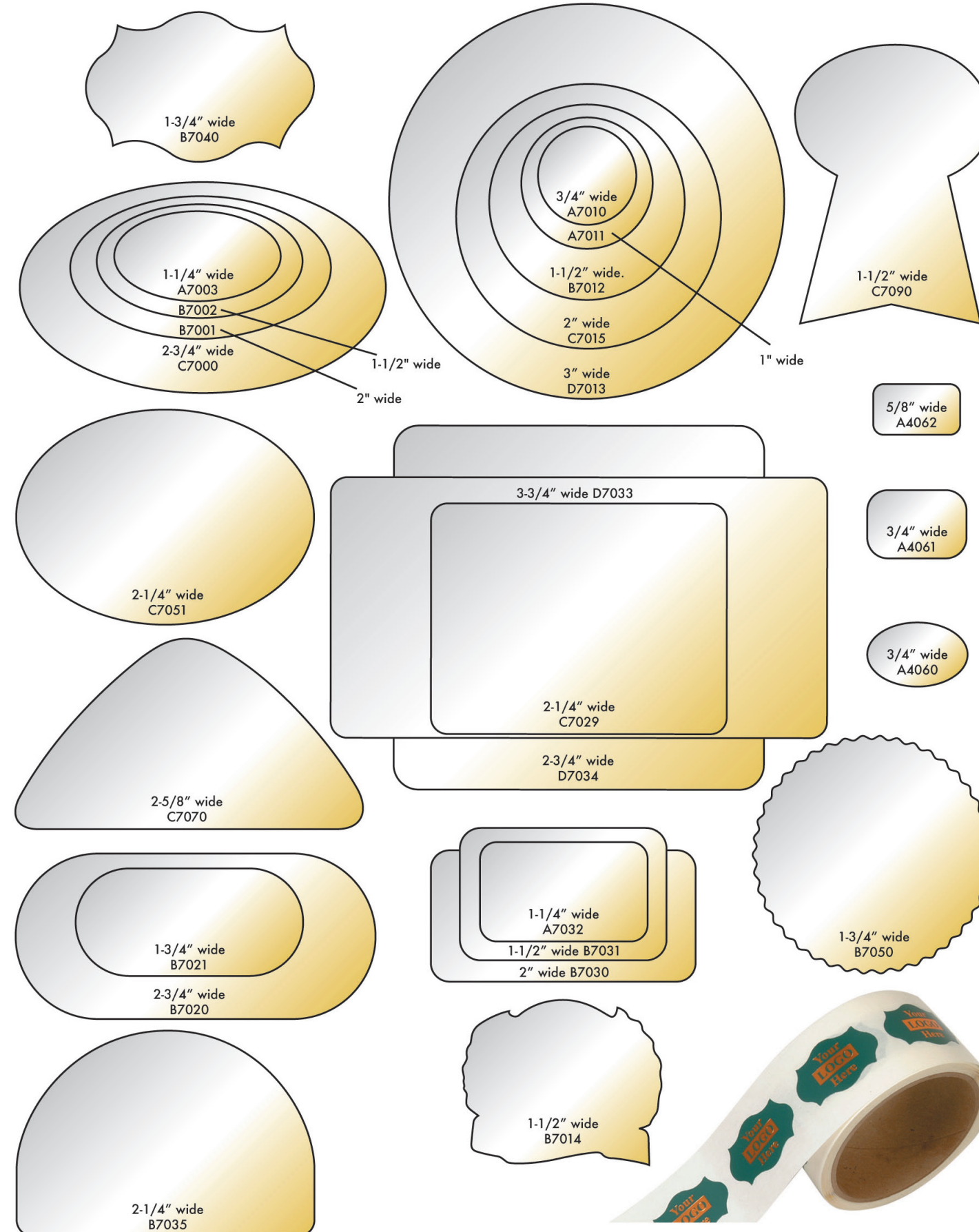
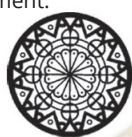

All print orders subject to set-up charges. Applicable artwork, and plate charges may apply. See page 98.

SPECIAL ORDER

SPECIAL ORDER

Please allow 4 - 6 weeks for printing from approved art. NO PLATE CHARGE!

Custom Full Colour Seals

Full colour, edge to edge print.
Thirty sizes to choose from.
"Picture Perfect" Seals

Speak with
your Sales
Representative
to order.

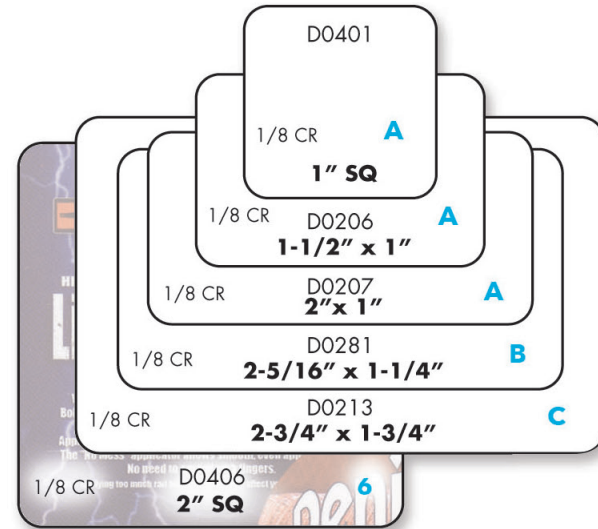

Please allow 4 - 6 weeks for printing from approved art.
NO PLATE CHARGE!

CUSTOM FULL COLOUR SEALS

CUSTOM FULL COLOUR SEALS

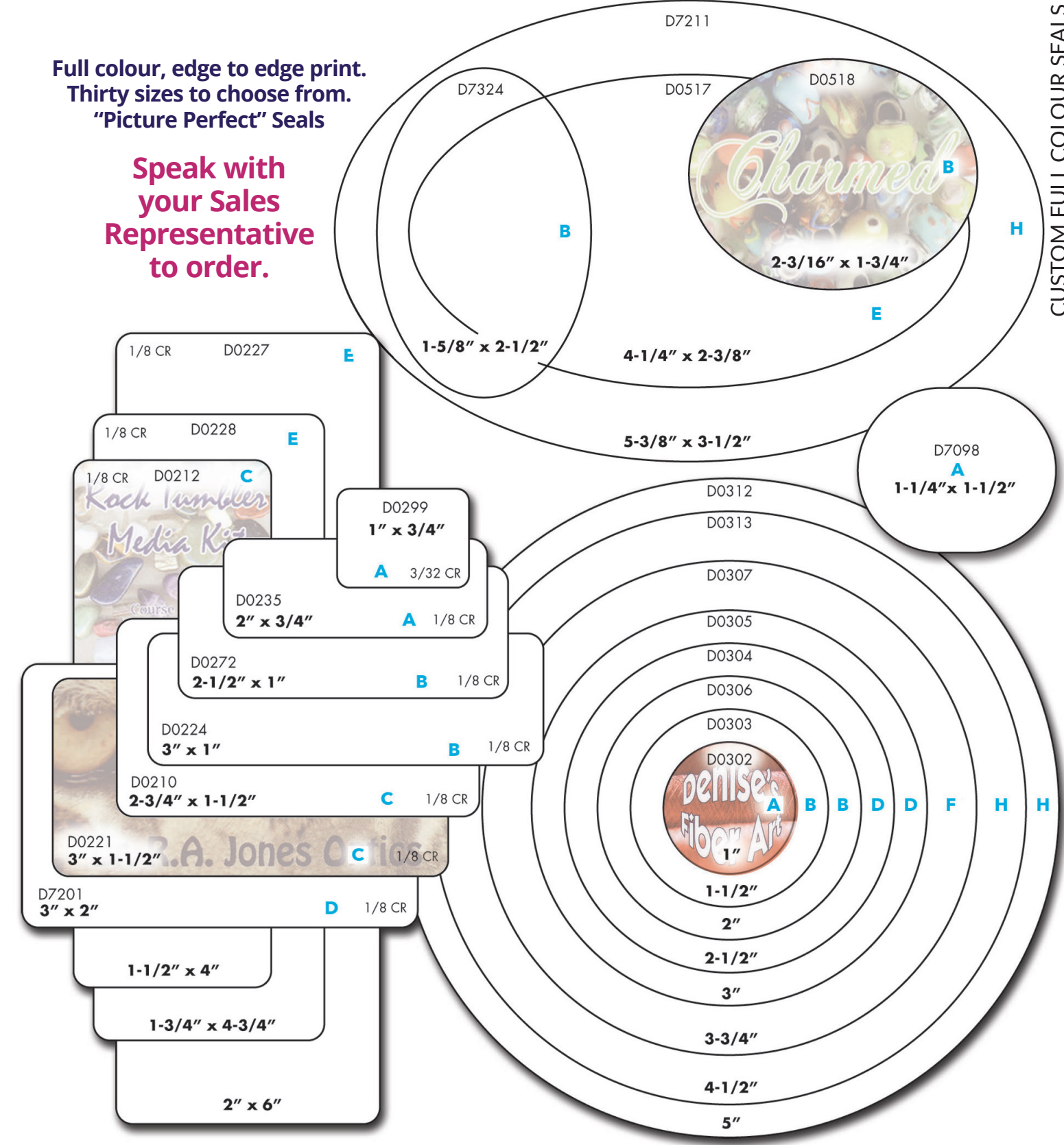
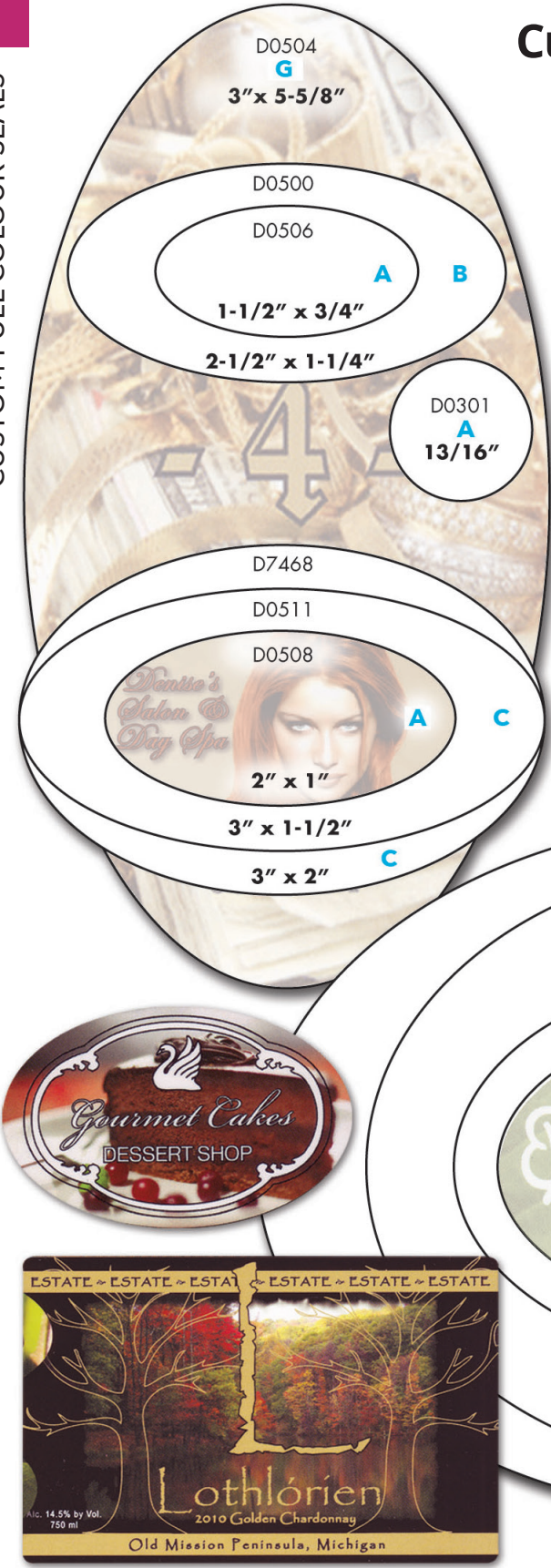







PRINTING INFORMATION

Have your name and logo printed... it's easy!

1. Select your box or bag style, colour and size.

2. Choose the printing method you wish to use.

-  A. **FOIL PRINTING:** Foil is applied to the bag or box using a combination of heat and pressure on a magnesium print plate to create an elegant appearance. Choice of Metallic or Matte foils. Cost of Foil Printing Print plate per size and colour - \$94.00 (maximum 30 square inches)
-  B. **PAD PRINTING:** Ink is applied to smooth surfaces allowing us to print your logo in places never before possible. Cost of Pad Print plate per size and colour - \$104.50 (maximum 3.75 square inches)
-  C. **FULL COLOUR DIGITAL PRINT:** Utilizing the latest 4-colour process technology, we now offer full colour digital printing graphics on non-laminated paper bags and boxes.
-  D. **FULL COLOUR TRANSFER:** We offer full colour transfer printed graphics on fabric and nylon bags using a heat press process. This full colour transfer print creates an image that allows for vibrant designs. Pricing is the same regardless of the amount of colours used in a design. Have your full colour image applied to your bags for just \$2.45 per bag (minimum 300 bags)
-  E. **INK PRINTING:** Ink is applied to the box or bag using a rubber printing plate. This method is ideal for larger coverage prints and is economically priced. Cost of Ink Printing Plate per size per colour starting at \$137.50. (maximum 25 square inches)
-  F. **SILK SCREEN:** Die fast ink is applied to Fabric Style Bags through a screen. The process allows the ink to permeate into the fabric dimples for optimal coverage. Screen charge of \$65.00 applies with each order.

3. Choose the Print Colour

When Foil Printing, select from 41 foil colours in 4 different finishes: Metallic (High Sheen or Matte), flat, gloss or pearlized. For ink printing select from our 9 standard colours for in stock items, or ask about Pantone Matching for Special Order items such as Simply Bags and Fabric Style Bags.

4. Send us your artwork.

If you are a new print customer, send us your artwork by e-mail. Artwork must be vector with fonts outlined or high resolution (300 dpi) actual size jpg if vector can not be located.

If you don't have artwork or your artwork needs adjustments, we have a talented design team who can assist you. Contact one of our sales representatives or email us your ideas today. For pricing, see the artwork charges section.

Acceptable Artwork Formats

- Vector files (preferred): Adobe Illustrator with .ai, .eps, or .pdf file extension. If the logo was ever professionally made, at a marketing agency, print shop or sign maker, they will have the logo on file. Check with the original graphic designer. If vector cannot be provided, ALL raster formats will be subject to additional art charges as in most cases it will have to be converted to a vector to meet our printers requirements.
- Raster files: (ie. PDF, PSD, TIF, or JPEG) Actual size, high resolution (300dpi or more), is required for all full colour reproduction.
- Please include fonts (.ttf) or convert fonts to outlines when sending ANY Illustrator file, saved as AI, EPS or PDF.

The following formats are NOT acceptable

- Publisher (.pub) • CorelDraw (.cdr) • small GIF or BMP internet images • low resolution JPG
- Any Word or spreadsheet documents - '.docx', '.xls', '.wpd', '.od'

If unsure about any format including "what is a vector" please send all inquiries to your inside Customer Service Rep.

OTHER PRINTING COSTS

Artwork Charges: As mentioned above, we have a talented creative team that can work with you to design, create, manipulate or re-size your store logo or name. Artwork service is charged at a rate of \$75.00/hour, min. 1/2 hour.

Set-up Charges: Every print job requires a machine to be set-up. A charge will be applied to every order. Foil, Ink, Pad and Digital printing is charged at \$37.00. Silk Screen printing is \$75. Please note: multiple print sizes of the same logo require multiple set-ups.

Plate Charges: Plate charges apply one-time only. Each time you require a 'new' print design (i.e. Logo change, Print Size Adjustment etc.) a new plate must be created. Once the plate is made, we will hold it for you in our warehouse and it will be available for all future printing requirements. Plate charges range in cost from \$94.00 for a Foil Printing plate to \$137.50+ for an Ink Printing Plate. (maximum 25 square inches)

FOIL STAMPING COLOURS

Metallic Options

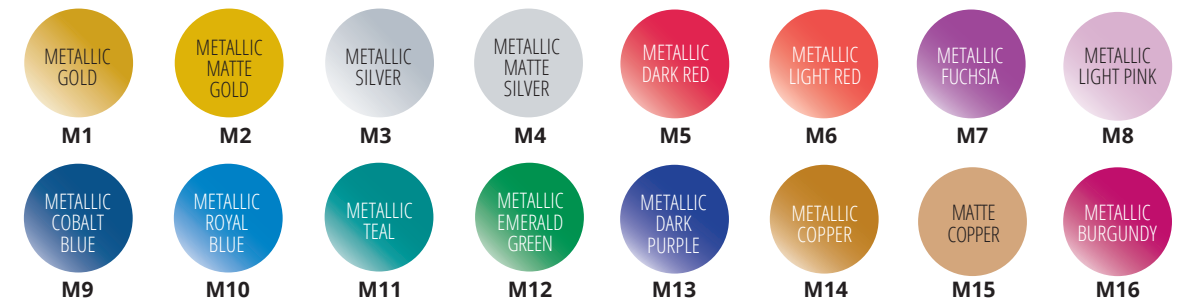

Metallic options feature a high sheen finish unless otherwise indicated as matte finish.

Flat Options



Pearlized Options

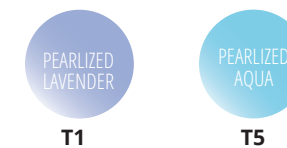

Gloss Options

Gloss Clear - allows the colour of the bag or box to show-through. Gives that tone on tone special highlighted look.



Satine Foil Colours



INK PRINTING COLOURS



PAD PRINTING COLOURS

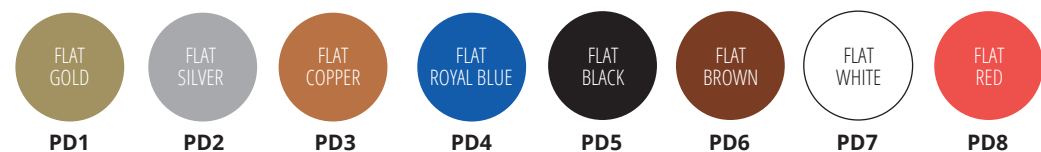

Colours shown are representations only and may not reflect true production colours.

Want it. Design it. Get it.

PLACE AN ORDER

Toll Free CANADA: 1.888.486.8437
Email: packaging@gunthermele.com

Toll Free USA: 1.800.516.0108
Email: gmp@gunthermele.com

Order on line: gunthermele.com



EASY PAYMENT OPTIONS

- Online at: gunthermele.com and pay with your credit card
- Over the phone, by: Visa or Mastercard
- Via your bank's online bill payment option by selecting "Gunther Mele" as payee
- Contact head office to set up EFT or ACH

Sign up for paperless billing. See our website for more information.

TERMS AND CONDITIONS:

- Minimum order \$250.00.
- F.O.B point CANADA: Brantford, Ontario Canada
- F.O.B. point USA: Buffalo, NY USA.
- Net 30 days O.A.C.
- New account payment terms: Visa or MasterCard 50% deposit with order, balance due upon shipping.
- Defective merchandise will be accepted back for credit only if claimed within 15 days of receipt of shipment. Authorization number must be obtained by contacting our customer service department 1.888.486.8437.
- In-transit damages and shortages must be claimed with the freight carrier at time of delivery.
- All lead times are estimates only (from receipt of approved artwork and credit) and are not guaranteed.
- Plate charges where applicable are:
 - Foil Print Dies: \$94.00 per size (maximum 30 square inches)
 - Pad Dies: \$104.50 per size (maximum 3.75 square inches)
 - Ink Plates \$137.50 (maximum 25 square inches)
- **While we strive for accuracy in our catalogue, actual product may be slightly different than pictured.**
- Prices subject to change without notice.

