

A collection of various colored jewelry boxes, some open showing rings, with a central text overlay. The boxes are in shades of gold, blue, green, red, purple, and silver. Some boxes have the text "Your LOGO Here" embossed on them. The central text is "PACKAGE WITH PURPOSE" in a bold, black, sans-serif font, with "WITH" in a smaller font size and centered between two horizontal bars.

PACKAGE WITH PURPOSE

GUNTHERMELE 1857

**JEWELRY PACKAGING GUIDE
2018 - VOLUME 161**

Discover Our Website

gunthermele.com



PROCESS AN ORDER • REVIEW ORDER HISTORY • MANAGE YOUR ACCOUNT • TRACK SHIPMENTS

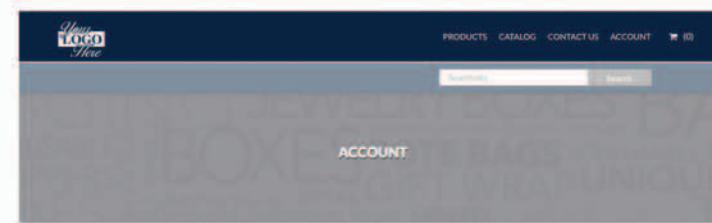
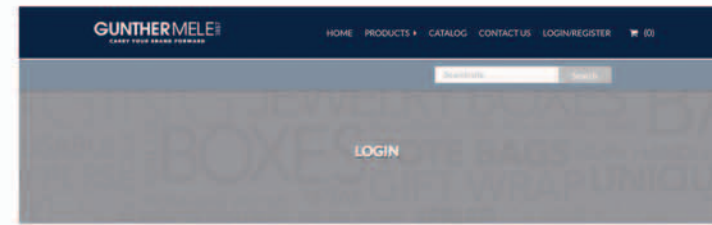
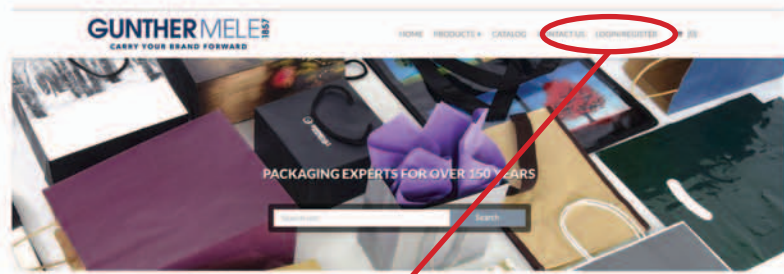

STEP 1

Click on the Login/Register button at the top of the menu bar on our website, to get started.

STEP 2

Next to Account Number, enter the six or eight-digit customer # that is associated with your account.

Enter your Zip/Postal Code associated with the billing address of your account. Press the Continue button.

STEP 3

When you have successfully logged on, you will see the message "Successful Login" on the Account Screen. At this point you can review current orders or place a new order.

Order History (A)

Current Open Orders - current orders in process that have not shipped.

Shipped Orders - orders that have shipped since June 1st, 2015 (tracking numbers provided for tracing recent orders).

Cancelled Orders - cancelled orders since June 1st, 2015.

Orders Shipped prior to May 31, 2015 - additional order history.

My Products (B)

Custom product recap of those items that have been created and produced specifically for your account.

Manage Account (C)

Ability to review and update all relevant information that is currently on file for your account ("Bill to" information).

If you need assistance accessing your account or using the functionality of our website, please contact us at 1.800.516.0108 or email us at gmp@gunthermele.com

TABLE OF CONTENTS

JEWELRY PACKAGING

New Hinged Packaging 5 - 27	Specialty and Gift with Purchase 35
Acrylic 28	Gift Card/Certificate Boxes and Folders 36 - 37
Folders and 2-Piece Jewelry Packaging 29 - 31	Pouches 38 - 39
New Nest Boxes 32 - 33	New Jewelry Cleaning Cloths and Cleaners 40 - 41
E-Commerce Boxes 34	Repair Envelopes and Tags 42

CREATE YOUR OWN LOOK

Jewelry Packaging Styles 43 - 57	Custom Materials, Colors and Pad Styles . 58 - 59
--	---

JEWELRY DISPLAYS

New In Stock Jewelry Displays 60 - 70	CYOL Element And Showcase
Create Your Own Look Color Options 71 - 73	Platform Styles 74 - 75
	Engagement Ring Display 76 - 77

BAGS

Rope Handle Paper Totes 78	San Francisco Shoppers 89
Eclipse and Geo Eurototes 79	Custom Paper Shoppers 90 - 91
Winter Forest, Christmas Village Bags 80	Poly Merchandise and Celestial Pattern Bags.. 92
London Shoppers 81	Frosted Poly Bags 93
Manhattan Tote Bags 82	Custom Printed Poly Merchandise Bags .. 94 - 95
Mod Tote Bags 83	Custom Printed Poly Shopping Bags 96 - 97
Custom Rope Handle Paper Eurototes 84 - 85	Reusable Shopping Bags 98
New Kraft and White Paper Bags 86 - 87	Toronto Totes and Metallic Reusable 99
Full Color Digital Printing Option 87	Custom Full Color Laminated Reusable ... 100 - 101
Color Paper Shoppers 88 - 89	Custom Reusable Fabric Shoppers 102 - 103
Graphic Design Paper Shoppers 88	

FOLDING BOXES

Folding Gift Boxes 104	E-Commerce Corrugated Boxes 106
Tuckit® Boxes 105	Special Order Pop-Up Boxes 107

TISSUE AND GIFT WRAP

Tissue Paper 108 - 109	Jewellers Rolls 111
New Inspirations Gift Wrap 110	Special Order Giftwrap 112 - 115

RIBBONS AND SEALS

Bows, Cellophane and Dispensers 116 - 117	Customized Seals - Full Color 124 - 125
Printed and Unprinted Ribbon 118 - 121	New Print Information and Colors 126 - 127
Customized Seals - Foil Print 122 - 123	

Stuck for ideas?
Visit us on social media!



Follow us on
Twitter



Like us on
Facebook



Be inspired by us on
Pinterest



Whisper Moonglow Hinged Packaging

See page 9 for more details.



Ultra Sonic Jewelry Cleaning Machine

See page 40 for more details.



Actual Size

Black 2-piece container with a die cut foam insert



150S - Matte Black 080S - Metallic Silver



Revolution

Twist motion modern approach to jewellery presentation.

- Stainless steel construction
 - Flocked ring pad
- 68021 _ _ _
2.125" x 1.625"
\$8.79/ea. 12/case



PAD PRINT
Add your logo to the top or sides. Maximums apply.
<500 is 22¢ each
>500 is 20¢ each



Twist the cylinder to raise and reveal the special ring inside.



Pendant/Earring Tray

See page 70 for more details.



All PAPER Eurototes with deboss print option

See page 86 for more details.



RINGSTASH



You've sold the perfect ring. They've planned the perfect moment.
Help them keep it a secret.

- Pocketable engagement ring box with pirouette motion clip -



Ring Stash

The solution to bulky engagement ring boxes.

- Discreet compact size
- Flexible ring clip firmly holds the ring in place
- Magnetic closure
- Light weight and durable
- Black sleeve packer
- Printing options available
- U.S. Patent #9375066



Max Stone Width:
3/8" (9.5mm)

Max Band Width:
5/32" (4mm)

Ring Stash is 1/5 the size of a standard ring box!

CODE	DESCRIPTION	SIZE (inches)	PRICE /EACH	
			12+	*RETAIL
68021015L	Ring Stash	2.32 x 2.44 x .55	\$19.90	\$65.00



FOIL PRINT
Add your logo to the top satin.
<500 - 20¢ each
>500 - 18¢ each



PAD PRINT
Add your logo to the lid.
<500 is 22¢ each
>500 is 20¢ each

* Ring Stash is available at Ringstash.com for \$65 but available only at Gunther Mele at wholesale pricing! [View the video at ringstash.com](http://www.ringstash.com)

All print orders subject to \$30 set-up charge. Applicable artwork, and plate charges may apply. See page 126.

Please allow 2 - 3 weeks for printed items from approved art.

IN STOCK

IN STOCK

Please allow 2 - 3 weeks for printed items from approved art.

- Burgundy Eurotote - see page 78
- Tissue - see page 108



- Silver Brougham**
Engravable chrome box with black velvet interior
- Packaged in a black knized flannel pouch inside a black traditional 2-piece outer box
 - Silver push button release
 - Combination Ring pad or Earring/Pendant pad



- 663 - Burgundy leatherette boxes with lacquered mahogany trim.**
- Ivory velvet pads with ivory satin top liners



- 113 - Blue leatherette boxes with lacquered oak trim.**
- Matching blue velvet pads with ivory satin top liners

Brougham

Leatherette box with lacquered wood trim.

- Velvet pads with ivory satin top liners
- Packaged in a 2-piece coordinating outer box
- Gold push button release
- Minimum 12 per style

CODE	DESCRIPTION	SIZE (inches)	PRICE /EACH	
			12+	144+
36921 ___	Ring	1.875 x 2 x 1.875	\$8.28	\$7.56
36932 ___	Earring	2.5 x 2.625 x 1.5	\$9.56	\$8.61
36963 ___	Pendant/Earring	3.25 x 3.5 x 1.75	\$11.60	\$10.43
36993 ___	Bracelet	8.75 x 2.125 x 1.375	\$14.49	\$13.04
36973 ___	Necklace	7.375 x 7.5 x 1.75	\$20.30	\$18.27

SILVER BROUGHAM			SPECIAL:	
36923990	Combo Ring/Pad Earring/Pendant	2 x 2.25 x 2	\$4 .95 each	

FOIL PRINT
Add your logo to the inside lid.
<500 - 20¢ each
>500 - 18¢ each

PAD PRINT
Add your logo to the lid.
<500 is 22¢ each
>500 is 20¢ each



- Eurototes - see page 78
- Tissue - see page 108

Onyx

Our premier wood series featuring a luxurious ebony and grey natural grain.

- Light grey suede pads and top liners
- Packaged in a black 2-piece outer box
- Minimum 12 per style

CODE	DESCRIPTION	SIZE (inches)	PRICE /EACH	
			12+	144+
36821990Z	Ring	2.36 x 2.36 x 2	\$8.32	\$7.47
36822990Z	Earring	2.36 x 2.36 x 2	\$8.23	\$7.47
36823990Z	Large Ring	2.95 x 2.95 x 2.25	\$10.12	\$8.90
36832990Z	Utility T-pad	3.35 x 3.35 x 2.25	\$10.97	\$9.65
36893990Z	Bracelet	9.25 x 2.36 x 1.5	\$11.39	\$10.02
36873990Z	Necklace	7 x 7 x 1.75	\$22.95	\$20.20

FOIL PRINT
Add your logo to the inside lid.
<500 - 20¢ each
>500 - 18¢ each

PAD PRINT
Add your logo to the lid.
<500 is 22¢ each
>500 is 20¢ each

All print orders subject to \$30 set-up charge. Applicable artwork, and plate charges may apply. See page 126.

All print orders subject to \$30 set-up charge. Applicable artwork, and plate charges may apply. See page 126.



- Aubergine Eurototes - see page 79
- Tissue - see page 108



Outer Box

Monterey II

Wood series with crisp lines and a gloss mahogany finish.

- Soft white leatherette interior
- Packaged in a 2-piece white traditional outer box
- Minimum 12 per style

CODE	DESCRIPTION	SIZE (inches)	PRICE /EACH	
			12+	144+
36821320M	Ring	2.375 x 2.375 x 2	\$5.76	\$4.99
36822320M	Earring	2.375 x 2.375 x 2	\$5.76	\$4.99
36843320M	Utility T-pad	4 x 4 x 2	\$10.51	\$8.89
36850320M	Watch	4.375 x 4.375 x 2.75	\$11.81	\$10.59
36893320M	Bracelet	9.5 x 2.375 x 1.5	\$11.54	\$10.36
36813320M	Necklace Box	7.5 x 7.5 x 2	\$19.57	\$17.56

FOIL PRINT
Add your logo to the inside lid.
<500 - 20¢ each
>500 - 18¢ each

PAD PRINT
Add your logo to the lid.
<500 is 22¢ each
>500 is 20¢ each



- Bronze Eurototes - see page 79
- Tissue - see page 108



New



Outer Box

Whisper Moonglow

Elegant curves and round corners covered in Moonglow Linea.

- Matching interiors
- Packaged in a coordinating 2-piece outer box
- Minimum 12 per style

CODE	DESCRIPTION	SIZE (inches)	PRICE/EACH	
			12+	144+
36821009W	Ring	2.375 x 2.375 x 2.125	\$5.76	\$4.99
36822009W	Earring	2.375 x 2.375 x 2.125	\$5.76	\$4.99
36823009W	Large Ring	3.25 x 3.25 x 2.25	\$8.39	\$7.30
36883009W	Utility T-pad	3.25 x 3.25 x 2.25	\$7.76	\$6.71
36850009W	Watch	4 x 4 x 2.75	\$10.49	\$9.12
36893009W	Bracelet	9.25 x 2.5 x 1.75	\$10.34	\$8.99
36873009W	Necklace	6.5 x 8 x 1.75	\$16.17	\$13.28



RING

FOIL PRINT
Add your logo to the inside lid.
<500 - 20¢ each
>500 - 18¢ each

PAD PRINT
Add your logo to the lid.
<500 is 22¢ each
>500 is 20¢ each



All print orders subject to \$30 set-up charge. Applicable artwork, and plate charges may apply. See page 126.

All print orders subject to \$30 set-up charge. Applicable artwork, and plate charges may apply. See page 126.



- Gold Eurotote - see page 78
- Tissue - see page 109

Whisper Noir

Elegant curves and round corners, covered in soft suede.

- Luxurious black on black
- Packaged in a coordinating 2-piece outer box
- Minimum 12 per style

CODE	DESCRIPTION	SIZE (inches)	PRICE /EACH	
			12+	144+
36821159W	Ring	2.375 x 2.375 x 2	\$5.76	\$4.99
36822159W	Earring	2.375 x 2.375 x 2	\$5.76	\$4.99
36823159W	Large Ring	3.25 x 3.25 x 2.25	\$7.76	\$6.71
36883159W	Utility T-pad	3.25 x 3.25 x 2.25	\$7.76	\$6.71
36850159W	Watch	4 x 4 x 2.75	\$10.49	\$9.12
36893159W	Bracelet	9.5 x 2.375 x 1.5	\$10.34	\$8.99
36790159W	Necklace Folder	5.5 x 7.5 x 1	\$7.85	\$6.90

FOIL PRINT
 <500 - 20¢ each
 >500 - 18¢ each

LARGE RING



- Black Eurotote - see page 78
- Tissue - see page 108

Whisper Palladium

Elegant curves and round corners covered in Palladium Linea.

- Matching interiors
- Packaged in a coordinating 2-piece outer box
- Minimum 12 per style

CODE	DESCRIPTION	SIZE (inches)	PRICE/EACH	
			12+	144+
36821289W	Ring	2.375 x 2.375 x 2.125	\$5.76	\$4.99
36822289W	Earring	2.375 x 2.375 x 2.125	\$5.76	\$4.99
36823289W	Large Ring	3.25 x 3.25 x 2.25	\$8.39	\$7.30
36883289W	Utility T-pad	3.25 x 3.25 x 2.25	\$7.76	\$6.71
36850289W	Watch	4 x 4 x 2.75	\$10.49	\$9.12
36893289W	Bracelet	9.25 x 2.5 x 1.75	\$10.34	\$8.99
36873289W	Necklace	6.5 x 8 x 1.75	\$16.17	\$13.28

FOIL PRINT
 <500 - 20¢ each
 >500 - 18¢ each

PAD PRINT
 Add your logo to the lid.
 <500 is 22¢ each
 >500 is 20¢ each

LARGE RING



All print orders subject to \$30 set-up charge. Applicable artwork, and plate charges may apply. See page 126.

All print orders subject to \$30 set-up charge. Applicable artwork, and plate charges may apply. See page 126.



- Celestial Blue Eurotote - see page 79
- Tissue - see page 108

813 - Linea Blue Celestial

Eclipse

Classic square corners with a distinctive "eclipse" style front.

- Packaged in white full-depth 2-piece outer box
- Minimum 12 per style

CODE	DESCRIPTION	SIZE (inches)	AUBERGINE AND BLUE PRICE/EACH		BROWN PRICE/EACH	
			12+	144+	12+	144+
36821 ___	Ring	2.5 x 2.5 x 1.75	\$4.99	\$4.49	\$3.56	\$3.22
36822 ___	Earring/Pendant	2.5 x 2.5 x 1.75	\$4.99	\$4.49	\$3.56	\$3.22
36883 ___	Utility T-pad	3.75 x 4 x 1.75	\$8.61	\$7.76	\$6.24	\$5.61
36893 ___	Bracelet	9.25 x 2.5 x 1.75	\$11.12	\$10.01	\$6.87	\$6.19
36873 ___	Necklace	6.5 x 8 x 1.75	\$18.01	\$16.22	\$14.02	\$12.66
36850 ___	Watch	3.75 x 4.25 x 3	\$12.00	\$10.79	\$7.99	\$7.20

FOIL PRINT
 <500 - 20¢ each
 >500 - 18¢ each

PAD PRINT
 Add your logo to the lid.
 <500 is 22¢ each
 >500 is 20¢ each



Outer Box

813 - Linea Blue Celestial



Outer Box

663 - Linea Aubergine



Outer Box

423 - Brown



813 - Linea Blue Celestial

- Rich Linea Blue Celestial covering • Ivory brushed leatherette pads and satin top liners • Packaged in a coordinating 2-piece outer box



663 - Linea Aubergine

- Rich Linea Aubergine covering • Ivory brushed leatherette pads and satin top liners • Packaged in a coordinating 2-piece outer box

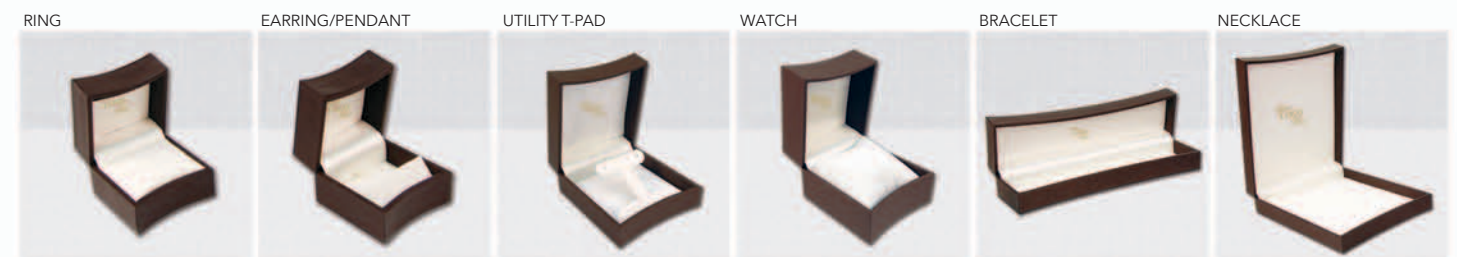

423 - Brown

- Rich Brown leatherette covering • Champagne color satin top liners and suedine pads • Packaged in a white 2-piece outer box



• Eurotote - see page 79

Please allow 2 - 3 weeks for printed items from approved art.

IN STOCK

IN STOCK

Please allow 2 - 3 weeks for printed items from approved art.

- Custom Eurotote - see page 84
- Tissue - see page 108
- Wrapping paper - starting on page 110
- Ribbon - see page 116



Hoop Earring Folder
- page 31

114 - Blue

ESTATE

Contemporary style with a touch of tradition.

- White velvet pads and satin top liners
- Packaged in a coordinating 2-piece outer box
- Minimum 12 per style

CODE	DESCRIPTION	SIZE (inches)	PRICE /EACH	
			12+	144+
36021 ___	Ring	2 x 2.25 x 1.875	\$3.66	\$3.45
36022 ___	Earring	2 x 2.125 x 1.625	\$3.66	\$3.45
36084 ___	Utility T-pad	3.5 x 3.5 x 1.5	\$4.35	\$3.95
36093 ___	Bracelet	8.5 x 2.125 x 1	\$7.02	\$6.54
36073 ___	Necklace	7.125 x 4.375 x 1.25	\$8.43	\$7.73

VOYAGEUR JEWELRY FOLDERS

36795 ___	Bracelet Folder	8.5 x 1.75	\$3.52	\$3.18
36790 ___	Necklace/Pearl Folder	6 x 8	\$5.59	\$5.04

 **FOIL PRINT**
<500 - 20¢ each
>500 - 18¢ each

 **PAD PRINT**
Add your logo to the lid.
<500 is 22¢ each
>500 is 20¢ each

114 - Blue



Outer Box

674 - Green



Outer Box

672 - Green



VOYAGEUR JEWELRY FOLDERS

674 - Green



- In Stock White Eurotote - see page 78
- Tissue - see page 108
- Cotton Filled Nest Boxes - see page 33
- Ribbon - see page 116



Palladium Inlay

Modern look - inside and out with updated detail.

- Palladium grey brushed exterior
- Cream pads and top liner with matching exterior edge
- Packaged in a coordinating 2-piece outer box
- Minimum 12 per style

CODE	DESCRIPTION	SIZE (inches)	PRICE/EACH	
			12+	144+
36221283P	Ring	2.25 x 2 x 1.75	\$4.75	\$3.90
36222283P	Earring	2.25 x 2 x 1.75	\$4.75	\$3.90
36283283P	Utility T-pad	3.18 x 4.17 x 1.41	\$6.70	\$5.69
36293283P	Bracelet	8.6 x 2.16 x 1	\$7.70	\$6.45
36273283P	Necklace	6.25 x 4.4 x 1.4	\$9.20	\$7.75

 **FOIL PRINT**
<500 - 20¢ each
>500 - 18¢ each

 **PAD PRINT**
Add your logo to the lid.
<500 is 22¢ each
>500 is 20¢ each



All print orders subject to \$30 set-up charge. Applicable artwork, and plate charges may apply. See page 126.

All print orders subject to \$30 set-up charge. Applicable artwork, and plate charges may apply. See page 126.

Please allow 2 - 3 weeks for printed items from approved art.

IN STOCK

IN STOCK

Please allow 2 - 3 weeks for printed items from approved art.

- Black Eurotote - see page 78
- White Tissue - see page 108



153 - Black

ROMA

Distinctive round corner styling with sculpted sides.

- Lizard style embossed covering with leatherette interior
- Packaged in a 2-piece coordinating outer box with ¼ depth lids
- Minimum 12 per style

Envelope Pouch w/Snap Closure. See page 38.

CODE	DESCRIPTION	SIZE (inches)	PRICE /EACH	
			12+	144+
36421 ___	Ring	2.25 x 2.25 x 1.75	\$3.79	\$3.42
36422 ___	Earring	2.25 x 2.25 x 1.75	\$3.79	\$3.42
36484 ___	Utility T-pad	3.75 x 3.75 x 2	\$5.72	\$4.89
36493 ___	Bracelet	9.375 x 2.25 x 1.5	\$7.85	\$7.06
36477 ___	Necklace	7.5 x 7.5 x 2.125	\$15.22	\$13.69

FOIL PRINT
 <500 - 20¢ each
 >500 - 18¢ each

PAD PRINT
 Add your logo to the lid.
 <500 is 22¢ each
 >500 is 20¢ each

VOYAGEUR JEWELRY FOLDERS

36795 ___	Bracelet Folder	8.5 x 1.75	\$3.52	\$3.18
36790 ___	Necklace/Pearl Folder	6 x 8	\$5.59	\$5.04



Outer Box



Outer Box



Voyageur Jewellery Folders
152 - Black Leatherette
002 - White Leatherette

153 - Black and 153B - Black on Black

123 - Brown



123 - Brown

- White leatherette pads and top liners
- Brown Lizard style embossed covering
- 2-piece outer box



153 - Black

- White leatherette pads and top liners
- Black Lizard style embossed covering
- 2-piece outer box



153B - Black on black

- Black leatherette pads and top liners
- Black Lizard style embossed covering
- 2-piece outer box



• Eurotote - see page 78

Please allow 2 - 3 weeks for printed items from approved art.

IN STOCK

IN STOCK

Please allow 2 - 3 weeks for printed items from approved art.



Proposal Ring Hinged Box

- Single ring box with matching ribbon pull accent and ring clip
- Brushed ivory linea interior
- Minimum case pack 12

36220 _____
2.36" x 2.36" x .94"
\$2.52 each (12+)
\$2.19 each (144+)



873B - Bronze



FOIL PRINT
<500 - 20¢ each
>500 - 18¢ each

- Eurotote - see page 79
- Tissue - see page 108



GEO

Textured coloring coupled with modern geometry.

- Ivory brushed leatherette pads and satin top liners
- Packaged in a coordinating ¾ depth 2-piece outer box
- Minimum 12 per style

CODE	DESCRIPTION	SIZE (inches)	PRICE /EACH	
			12+	144+
36221 _____	Ring/Earring	2.375 x 2.375 x 2.375	\$3.05	\$2.73
36283 _____	T-pad Pendant	3.5 x 4.5 x 1.5	\$4.04	\$3.47
36293 _____	Bracelet	9 x 2.375 x 1.5	\$5.34	\$4.80
36273 _____	Necklace	7 x 7 x 1.5	\$9.07	\$8.17
36220 _____	*Proposal Box	2.36 x 2.36 x .94	\$2.52	\$2.19
36224 _____	*Lighted Ring/Earring Box	2.36 x 2.36 x 2.36	\$8.39	\$7.76
09030 _____	*Pouch with Box	3 x 4	\$2.29	\$1.94

* not available in Luxe Silver

FOIL PRINT
<500 - 20¢ each
>500 - 18¢ each

PAD PRINT
Add your logo to the lid.
<500 is 22¢ each
>500 is 20¢ each



873B - Bronze

563P - Purple

153B - Black

083 - Luxe Silver



873B - Bronze

- Ivory brushed leatherette pads with satin top liners
- Packaged in a coordinating 2-piece outer box
- Minimum 12 per style

427T - Geo pouch in white with matching taupe gift box



563P - Purple

- Ivory brushed leatherette pads with satin top liners
- Packaged in a coordinating 2-piece outer box
- Minimum 12 per style

456P - Geo pouch in white with matching purple gift box



153B - Black

- Ivory brushed leatherette pads with satin top liners
- Packaged in a coordinating 2-piece outer box
- Minimum 12 per style

415B - Geo pouch in white with matching black gift box



083 - Luxe Silver

- Ivory brushed leatherette pads with satin top liners
- Packaged in a coordinating 2-piece outer box
- Minimum 12 per style



• Eurotote - see page 78

All print orders subject to \$30 set-up charge. Applicable artwork, and plate charges may apply. See page 126.

All print orders subject to \$30 set-up charge. Applicable artwork, and plate charges may apply. See page 126.

Please allow 2 - 3 weeks for printed items from approved art.

IN STOCK

IN STOCK

Please allow 2 - 3 weeks for printed items from approved art.

- Trapezoid Eurotote - see page 78
- Blue Tissue - see page 108
- Ribbon - see page 116



313 - Aqua



Outer Box

313 - Aqua



Outer Box

312 - Brown

Vantage

Fresh, fashion-forward colors with clean lines provide a beautiful presentation.

- White leatherette interior
- Packaged in a coordinating full-depth 2-piece outer box
- Minimum 12 per style

CODE	DESCRIPTION	SIZE (inches)	PRICE /EACH	
			12+	144+
36221 ___	Ring	2 x 2 x 1.625	\$3.85	\$3.47
36222 ___	Earring	1.875 x 1.875 x 1.45	\$3.85	\$3.47
36284 ___	Utility T-pad	3.5 x 3.5 x 2	\$4.45	\$3.99
36293 ___	Bracelet	8.625 x 2.125 x 1.25	\$7.58	\$6.83
36273 ___	Necklace	6.25 x 4.5 x 1.5	\$9.89	\$8.90

FOIL PRINT
 <500 - 20€ each
 >500 - 18€ each

PAD PRINT
 Add your logo to the lid.
 <500 is 22€ each
 >500 is 20€ each



- Silver Eurototes - see page 78
- White Tissue - see page 108
- Bows - see page 116



Outer Box



002 - White VOYAGEUR JEWELRY FOLDERS

FOIL PRINT
 <500 - 20€ each
 >500 - 18€ each

PAD PRINT
 Add your logo to the lid.
 <500 is 22€ each
 >500 is 20€ each

Elan

Sweeping lines and distinctive styling.

- Soft, white leatherette covering
- Coordinating leatherette pads and white satin top liners
- Packaged in a white traditional 2-piece outer box
- Minimum 12 per style

CODE	DESCRIPTION	SIZE (inches)	PRICE /EACH	
			12+	144+
36021002	Single Ring	2 x 2.25 x 1.625	\$2.51	\$2.26
36041002	Large Ring	3 x 2 x 1.5	\$3.01	\$2.70
36022002	Earring	2 x 2.25 x 1.5	\$2.51	\$2.26
36084002	Utility T-pad	3.5 x 3.5 x 1.375	\$4.46	\$3.94
36093002	Bracelet	8.625 x 2.25 x 1	\$4.40	\$3.96
36073002	Necklace	7.125 x 4.375 x 1.25	\$6.27	\$5.65
VOYAGEUR JEWELRY FOLDERS				
36795 ___	Bracelet Folder	8.5 x 1.75	\$3.52	\$3.18
36790 ___	Necklace/Pearl Folder	6 x 8	\$5.59	\$5.04



All print orders subject to \$30 set-up charge. Applicable artwork, and plate charges may apply. See page 126.

All print orders subject to \$30 set-up charge. Applicable artwork, and plate charges may apply. See page 126.

Please allow 2 - 3 weeks for printed items from approved art.

IN STOCK

IN STOCK

Please allow 2 - 3 weeks for printed items from approved art.



- Silver Eurotote - see page 78
- Tissue - see page 109



151 - Black



671 - Green

VOYAGEUR JEWELRY FOLDERS

672 - Green



152 - Black

Bead Pad

- pad fits stud earring box
- ribbon threads through bead
- ribbon wraps to back and is held by clip

RING LARGE RING



BRACELET NECKLACE



Jewellers Velvet

Traditions endure.

- Satin top liners
- Packaged in a white 2-piece outer box
- Minimum 12 per style

CODE	DESCRIPTION	SIZE (inches)	PRICE /EACH	
			12+	144+
36121 ___	Ring	2 x 2.125 x 1.5	\$1.80	\$1.64
36141 ___	Large Ring	2.5 x 2 x 1.5	\$2.30	\$2.07
36122 ___	Earring	2 x 2.125 x 1.5	\$1.80	\$1.64
36132 ___	Utility T-pad	2.5 x 2.5 x 1.25	\$3.64	\$3.27
36163 ___	Pendant	2.25 x 3 x 1.125	\$2.30	\$2.07
36183 ___	Utility	3.5 x 3.375 x 1.5	\$3.64	\$3.27
36193 ___	Bracelet	8 x 2 x 1.25	\$3.76	\$3.39
36173 ___	Necklace	7 x 4.25 x 1.5	\$6.30	\$5.68
69221000B	Bead Pad for earring box		\$0.65	\$0.54

VOYAGEUR JEWELRY FOLDERS

36795 ___	Bracelet Folder	8.5 x 1.75	\$3.52	\$3.18
36790 ___	Necklace/Pearl Folder	6 x 8	\$5.59	\$5.04



FOIL PRINT
 <500 - 20¢ each
 >500 - 18¢ each



- Gold Eurotote - see page 78
- Tissue - see page 109
- Bows - see page 116



Outer Box

Gold Galleria

A new gold standard. Classic presentation.

- White velour pads and satin top liners
- Packaged in a white traditional 2-piece outer box
- Minimum 12 per style



Hoop Earring Folder
 - page 29

RING

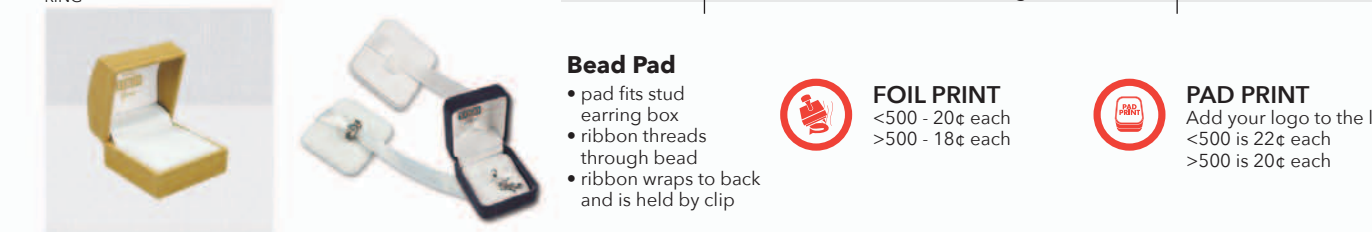

EARRING LARGE RING UTILITY T-PAD BRACELET NECKLACE BANGLE



CODE	DESCRIPTION	SIZE (inches)	PRICE /EACH	
			12+	144+
36621073	Ring	2.125 x 2 x 2	\$1.94	\$1.74
36622073	Earring	2.125 x 2 x 2	\$1.94	\$1.74
36641073	Large Ring	3 x 2 x 2	\$2.29	\$2.06
36684073	Utility T-pad	3.5 x 3.5 x 1.5	\$3.07	\$2.63
36693073	Bracelet	8.25 x 2.125 x 1.25	\$4.23	\$3.81
36673073	Necklace	6.25 x 5 x 1.5	\$6.87	\$6.18
36650073	Bangle	1.25 x 3.75 x 3.125	\$3.31	\$2.99
69621000B	Bead Pad for earring box		\$0.65	\$0.54

Bead Pad

- pad fits stud earring box
- ribbon threads through bead
- ribbon wraps to back and is held by clip



FOIL PRINT
 <500 - 20¢ each
 >500 - 18¢ each



PAD PRINT
 Add your logo to the lid.
 <500 is 22¢ each
 >500 is 20¢ each

All print orders subject to \$30 set-up charge. Applicable artwork, and plate charges may apply. See page 126.

All print orders subject to \$30 set-up charge. Applicable artwork, and plate charges may apply. See page 126.

- Wrapping paper - see page 110
- Ribbon - see page 116



153 - Black

Horizon

A sweeping curved adds a unique look.

- White velour pads and satin top liners
- Packaged in a white traditional 2-piece outer box
- Minimum 12 per style

CODE	DESCRIPTION	SIZE (inches)	PRICE /EACH	
			12+	144+
36621 ___	Ring	2.125 x 2 x 2	\$1.94	\$1.74
36622 ___	Earring	2.125 x 2 x 2	\$1.94	\$1.74
36641 ___	Large Ring	3 x 2 x 2	\$2.29	\$2.06
36684 ___	Utility T-pad	3.5 x 3.5 x 1.5	\$3.09	\$2.52
36693 ___	Bracelet	8.25 x 2.125 x 1.25	\$4.23	\$3.81
36673 ___	Necklace	6.25 x 5 x 1.5	\$6.87	\$6.18
36650 ___	Bangle	1 x 3.75 x 3.125	\$3.31	\$2.99
69621000B	Bead Pad	for earring box	\$0.65	\$0.54

BLACK PADS AVAILABLE (3 SIZES)

36621153B	Single Ring Pad (black)	2.125 X 2	box w/pad	\$1.94	\$1.74
69622153B	Stud Earring Pad (black)	2.125 x 2	pad only	\$0.26	\$0.26
69633153B	Pend/Earring Pad (black)	2.75 x 2.75	pad only	\$0.26	\$0.26

VOYAGEUR JEWELRY FOLDERS

36795 ___	Bracelet Folder	8.5 x 1.75		\$3.52	\$3.18
36790 ___	Necklace/Pearl Folder	6 x 8		\$5.59	\$5.04



Bead Pad

- pad fits stud earring box
- ribbon threads through bead
- ribbon wraps to back and is held by clip

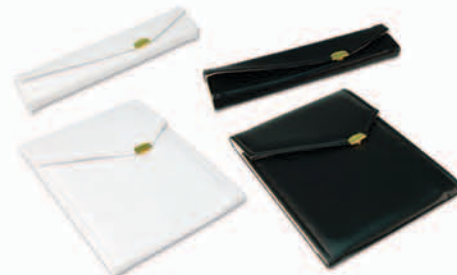

002 - White 152 - Black
VOYAGEUR JEWELRY FOLDERS

FOIL PRINT
<500 - 20¢ each
>500 - 18¢ each

PAD PRINT
Add your logo to the lid.
<500 is 22¢ each
>500 is 20¢ each



Outer Box



Outer Box



Outer Box



003 - White

- White velour pads and white satin top liners
- Packaged in a white 2-piece outer box
- Minimum 12 per style

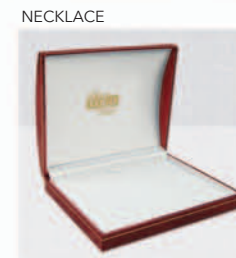

663 - Burgundy

- White velour pads and white satin top liners
- Packaged in a white 2-piece outer box
- Minimum 12 per style

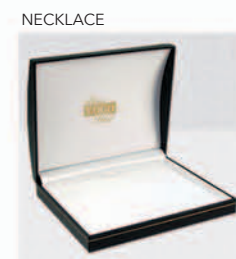

153 - Black

- White velour pads and white satin top liners
- Packaged in a white 2-piece outer box
- Minimum 12 per style

Please allow 2 - 3 weeks for printed items from approved art.

IN STOCK

IN STOCK

Please allow 2 - 3 weeks for printed items from approved art.



Econolux

Style meets value.

- Soft, white leatherette covering
- White suedine pads and satin top liners
- Packaged in a white tuck outer box (2-piece traditional outer box available)
- Minimum 12 per style

Bead Pad

- pad fits stud earring box
- ribbon threads through bead
- ribbon wraps to back and is held by clip



CODE	DESCRIPTION	SIZE (inches)	PRICE /EACH		2 PIECE OUTER BOX PRICE /EACH	
			12+	144+	31 ___ 003	
36121002	Ring	1.875 x 2.125 x 1.375	\$1.28	\$1.14	121	\$0.26
36141002	Large Ring	2.375 x 2 x 1.375	\$1.39	\$1.25	141	\$0.32
36122002	Earring	1.875 x 2.125 x 1.375	\$1.28	\$1.14	121	\$0.26
36163002	Pendant	2.25 x 3 x 1.125	\$1.74	\$1.56	163	\$0.32
36132002	T-pad Pendant	2.5 x 2.5 x 1	\$1.74	\$1.56	132	\$0.32
36193002	Bracelet	8 x 2 x 1.125	\$2.68	\$2.40	193	\$0.37
36173002	Necklace	7 x 4.25 x 1.375	\$4.55	\$4.10	173	\$0.63
36183002	Utility	3.875 x 3.25 x 1.375	\$2.68	\$2.40	183	\$0.37
69221000B	Bead Pad for earring box		\$0.65	\$0.54	-	-



Additional charge for optional 2-piece outer box



FOIL PRINT
<500 - 20¢ each
>500 - 18¢ each



PAD PRINT
Add your logo to the lid.
<500 is 22¢ each
>500 is 20¢ each



Bead Pad

- pad fits stud earring box
- ribbon threads through bead
- ribbon wraps to back and is held by clip



Econoline Blue

Value priced velvet.

- Soft, navy blue velour covering
- Coordinating pads and white satin top liners
- Packaged in a white sleeve (2-piece outer box available)
- Minimum 12 per style



Additional charge for optional 2-piece outer box



FOIL PRINT
<500 - 20¢ each
>500 - 18¢ each



PAD PRINT
Add your logo to the lid.
<500 is 22¢ each
>500 is 20¢ each

CODE	DESCRIPTION	SIZE (inches)	PRICE /EACH		2 PIECE CONTAINER PRICE /EACH	
			12+	144+	31 ___ 003	
36121119	Ring	1.875 x 2.125 x 1.375	\$1.28	\$1.14	121	\$0.26
36141119	Large Ring	2.375 x 2 x 1.5	\$1.39	\$1.25	141	\$0.32
36122119	Earring	1.875 x 2.125 x 1.375	\$1.28	\$1.14	121	\$0.26
36163119	Pendant	2.25 x 3 x 1.125	\$1.74	\$1.56	163	\$0.32
36132119	T-pad Pendant	2.5 x 2.5 x 1.25	\$1.74	\$1.56	132	\$0.32
36193119	Bracelet	8 x 2.125 x 1	\$2.68	\$2.40	193	\$0.37
36173119	Necklace	7 x 4.25 x 1.375	\$4.55	\$4.10	173	\$0.63
36183119	Utility	3.875 x 3.25 x 1.375	\$2.68	\$2.40	183	\$0.37
69221000B	Bead Pad for earring box		\$0.65	\$0.54	-	-



Glitter

Clean lines wrapped in stunning metallic sparkle paper

- White faux-suede pads and satin top liners
- Packaged in black sleeve
- Minimum 12 per style

CODE	DESCRIPTION	SIZE (inches)	PRICE /EACH	
			12+	144+
36221183	Ring	1.75 x 2 x 1.5	\$1.70	\$1.42
36222183	Earring	1.75 x 2 x 1.5	\$1.70	\$1.42
36284183	Utility T-pad	3.5 x 3.5 x 1.25	\$2.85	\$2.51
36293183	Bracelet	8.75 x 2.125 x 1	\$3.68	\$3.19
36273183	Necklace	6.25 x 4.25 x 1.25	\$4.68	\$4.05

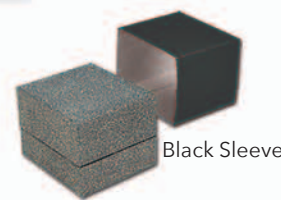

FOIL PRINT
<500 - 20¢ each
>500 - 18¢ each



PAD PRINT
Add your logo to the lid.
<500 is 22¢ each
>500 is 20¢ each



Royale

Hinged, white paperboard boxes covered in handsome ribbed paper with gold accent lines.

- Imprint available inside or on top of lid
- Flocked foam pads • Minimum one case pack

CODE	DESCRIPTION	SIZE (inches)	CASE	PRICE/EACH	
				50+	1000+
31545003	Ring/Earring	2.5 x 2 x 1.5	100	\$0.69	\$0.66
31533003	Pendant/Earring	2.75 x 2.75 x 1	100	\$0.84	\$0.77
31560003	Utility	3.5 x 3.5 x 1	50	\$1.24	\$1.18
31580003	Bracelet	8.125 x 2.125 x 1	50	\$1.67	\$1.58
31575003	Necklace	6.5 x 4.5 x 1	50	\$2.38	\$2.23



FOIL PRINT
<500 - 20¢ each
>500 - 18¢ each



PAD PRINT
Add your logo to the lid.
<500 is 22¢ each
>500 is 20¢ each

All print orders subject to \$30 set-up charge. Applicable artwork, and plate charges may apply. See page 126.

All print orders subject to \$30 set-up charge. Applicable artwork, and plate charges may apply. See page 126.

Please allow 2 - 3 weeks for printed items from approved art.

IN STOCK

IN STOCK

Please allow 2 - 3 weeks for printed items from approved art.



- **NEW!** Necklace Folder - see page 31
- Eurotote - see page 78
- Tissue - see page 108

Diamond Ice

Contemporary style with clean and curved edges.

- 2-piece acrylic with pearl or bronze paper backing
- Packaged in a coordinating 2-piece outer box
- Minimum 12 per style

CODE	DESCRIPTION	SIZE (inches)	PRICE /EACH	
			12+	144+
36321 _ _ _ _	Ring	2.36 x 2.36 x 2.16	\$6.30	\$5.46
36322 _ _ _ _	Earring	2.36 x 2.36 x 2.16	\$6.30	\$5.46
36383 _ _ _ _	T-pad	3.30 x 3.30 x 3	\$9.48	\$8.22
36350871B	Watch - Bronze only	4 x 4 x 3.75	\$9.90	\$8.52



871B - Bronze



001P - Pearl

FOIL PRINT
 <500 - 20¢ each
 >500 - 18¢ each

PAD PRINT
 Add your logo to the lid.
 <500 is 22¢ each
 >500 is 20¢ each

001P - Pearl



- Eurototes - see page 79
- Ribbon - see page 116
- Wrapping paper - see page 110



E-Commerce Jewelry Boxes

Deliver the 'in-store' experience to your customer's door

See page 34 for more information

Velocity

Boxes with ribbons for an elegant finish.

- Taupe or Black paper wrap boxes with white velour pads and white or brown organza ribbon
- Packaged in individual white sleeves
- Imprint available on inside lid
- Minimum 1 case pack



273 - Taupe



153 - Black

CODE	DESCRIPTION	SIZE (inches)	CASE	PRICE/EACH	
				25+	1000+
31221 _ _ _	Ring	2.5 x 2.25 x 2	50	\$1.52	\$1.30
31283 _ _ _	Utility	3 x 3 x 2	50	\$2.11	\$1.82
31293 _ _ _	Bracelet	9 x 2.25 x 1.5	25	\$2.89	\$2.48
31273 _ _ _	Necklace	6.25 x 8 x 2	25	\$3.81	\$3.44

FOIL PRINT
 <500 - 20¢ each
 >500 - 18¢ each

PAD PRINT
 Add your logo to the lid.
 <500 is 22¢ each
 >500 is 20¢ each

153 - BLACK

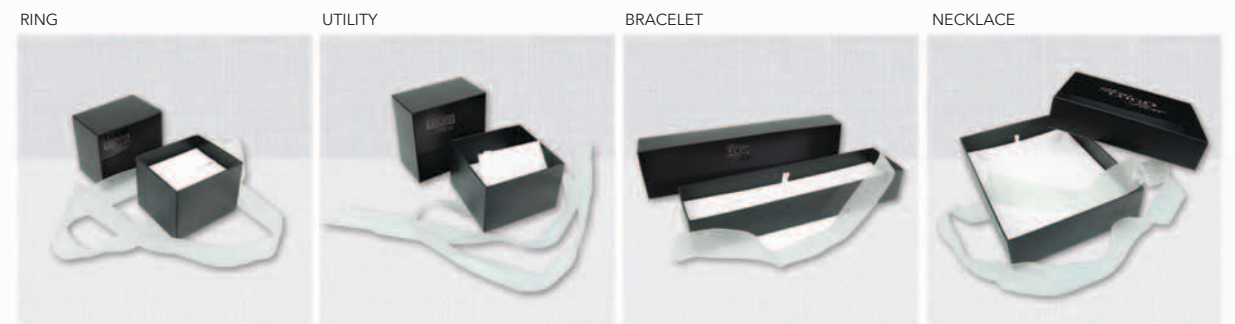

All print orders subject to \$30 set-up charge. Applicable artwork, and plate charges may apply. See page 126.

All print orders subject to \$30 set-up charge. Applicable artwork, and plate charges may apply. See page 126.

Please allow 2 - 3 weeks for printed items from approved art.

IN STOCK

IN STOCK

Please allow 2 - 3 weeks for printed items from approved art.



Romance

An easy-tie ribbon and contrasting edge reveal.

- Ivory with tan paper wrap boxes with white velour pads and organza ribbon
- Packaged in individual white sleeves • Minimum 1 case pack



CODE	DESCRIPTION	SIZE (inches)	CASE	PRICE/EACH	
				50+	1000+
31221863	Ring	2.5 x 2.25 x 2	100	\$1.39	\$1.31
31222863	Earring	2 x 1.5 x 1.187	100	\$1.32	\$1.18
31263863	Utility	3 x 3 x 2.125	100	\$1.56	\$1.43
31293863	Bracelet	9 x 2.375 x 1.5	50	\$2.29	\$2.02
31273863	Necklace	6.375 x 8 x 2	50	\$3.01	\$2.77

FOIL PRINT
 <500 - 20¢ each
 >500 - 18¢ each

PAD PRINT
 Add your logo to the lid.
 <500 is 22¢ each
 >500 is 20¢ each



Shadow

Two piece charcoal and silver paperboard box with a recessed wave.

- White flocked foam pads • Imprint available inside or on top of lid
- Minimum one case pack



CODE	DESCRIPTION	SIZE (inches)	CASE	PRICE/EACH	
				50+	1000+
31511308	Charm	2 x 2 x 1	50	\$0.95	\$0.91
31521308	Ring/Earring	2 x 2 x 1.75	50	\$1.01	\$0.95
31563308	Pendant/Earring	3.5 x 3.5 x 1.25	50	\$1.41	\$1.31
31593308	Bracelet	9 x 2 x 1	50	\$2.05	\$1.93
31573308	Necklace	6 x 6 x 1.5	50	\$2.49	\$2.52

FOIL PRINT
 <500 - 20¢ each
 >500 - 18¢ each

PAD PRINT
 Add your logo to the lid.
 <500 is 22¢ each
 >500 is 20¢ each



Necklace Folders

Stylish soft brushed leatherette folders with magnetic closures.

- Satin interior
- Packaged in a 2-piece matching outer box
- Minimum 12 per style

36790 __ __
 Necklace Folder
 5.5" x 7.5" x 1"
 12+ \$7.85 each
 144+ \$6.90 each

FOIL PRINT
 <500 - 20¢ each
 >500 - 18¢ each

PAD PRINT
 Add your logo to the lid.
 <500 is 22¢ each
 >500 is 20¢ each

Voyageur Jewelry Folders

Stylish soft leatherette folders with brass snap closures.

- Satin interior
- Packaged in a 2-piece white outer box
- Minimum 12 per style



FOIL PRINT
 <500 - 20¢ each
 >500 - 18¢ each

PAD PRINT
 Add your logo to the lid.
 <500 is 22¢ each
 >500 is 20¢ each

CODE	DESCRIPTION	SIZE (inches)	PRICE/EACH	
			12+	144+
A 36795 __ __	Bracelet Folder	8.5 x 1.75	\$3.52	\$3.18
B 36790 __ __	Necklace/Pearl Folder	6 x 8	\$5.59	\$5.04

Hoop Earring Folder

Charcoal ultrasuede folder with top stitch finish and black interior. Holds hoop earrings up to 2.75" in diameter.

- Size: 4.5" x 4.5"
- Packaged in a white 2 piece outer box
- Case pack of 12



FOIL PRINT
 <500 - 20¢ each
 >500 - 18¢ each

CODE	PRICE /EACH	
	12+	144+
36791015	\$3.35	\$2.90

All print orders subject to \$30 set-up charge. Applicable artwork, and plate charges may apply. See page 126.

All print orders subject to \$30 set-up charge. Applicable artwork, and plate charges may apply. See page 126.

Nest Boxes

Please allow 2 - 3 weeks for printed items from approved art.

IN STOCK

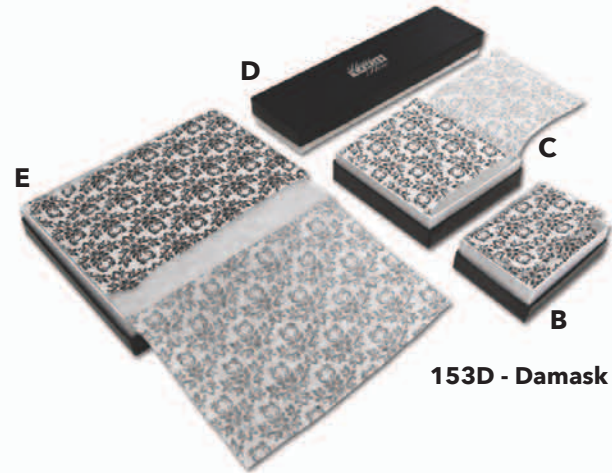

153D - Damask



103 - White Economy

CODE	DESCRIPTION	CASE SIZE (inches)	PACK	PRICE/EACH WHITE ECONOMY		PRICE/EACH DAMASK	
				50+	1000+	100+	1000+
A 31502103	Charm	2.5 x 1.5 x .875	100	\$0.35	\$0.32	N/A	N/A
B 31570 ___	Earring	3 x 2.125 x 1	100	\$0.37	\$0.33	\$0.55	\$0.53
C 31555 ___	Brooch	3.5 x 3.5 x 1	100	\$0.42	\$0.39	\$0.67	\$0.64
D 31564 ___	Bracelet	8 x 2 x .875	100	\$0.46	\$0.44	\$0.79	\$0.76
E 31558 ___	Necklace	6 x 5 x 1	100	\$0.72	\$0.68	\$1.14	\$1.10
F 31576103	Large Necklace	8 x 5.5 x 1.25	50	\$1.20	\$1.13	N/A	N/A
G 31259103	Stand-Up Bangle	3.5 x 2 x 2 x 2	100	\$1.88	\$1.69	N/A	N/A

Minimum order is one case pack



FOIL PRINT
<500 - 20¢ each
>500 - 18¢ each

PAD PRINT
Add your logo to the lid.
<500 is 22¢ each
>500 is 20¢ each

Nest Boxes

Estimated Lead Time - Please allow 3 weeks for unprinted items and 4 weeks for printed items from approved art.

SPECIAL ORDER



Our paperboard boxes are made with 100% recycled board



Eco-Friendly 100% recycled board colors + FSC paper wraps.



SOLID COLORS! MIX AND MATCH!



ECO FRIENDLY

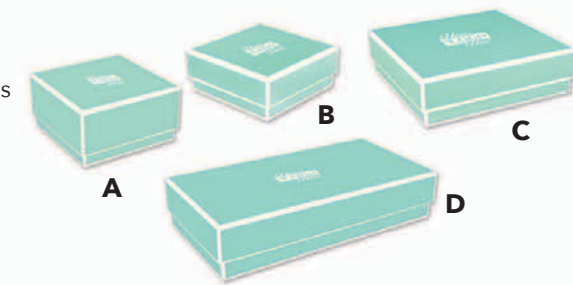

FOIL PRINT
<500 - 20¢ each
>500 - 18¢ each

PAD PRINT
Add your logo to the lid.
<500 is 22¢ each
>500 is 20¢ each

These boxes match our San Francisco Shoppers! See page 89.



Berkeley Nest Boxes

- Please allow 3 weeks for unprinted boxes, 4 weeks for printed boxes
- White flocked platform inserts
- Contemporary styling matches our San Francisco Shoppers
- Available in seven colors and four sizes
- Minimum 1 case pack

CODE	SIZE (inches)	CASE	PRICE/EACH	
			100+	1000+
A 32201 ___	3 x 3 x 1.25	100	\$1.43	\$1.31
B 32202 ___	3.5 x 3.5 x 2	100	\$1.57	\$1.44
C 32203 ___	5 x 5 x 1	100	\$1.94	\$1.78
D 32204 ___	9 x 4.5 x 2	100	\$2.58	\$2.36



849 - Red 192 - Solid White 613 - Slate Grey 231 - Black



138 - White 548 - Fuchsia 916 - Aqua

All print orders subject to \$30 set-up charge. Applicable artwork, and plate charges may apply. See page 126.

Cotton Filled Nest Boxes

SOLID COLOR & ECO FRIENDLY PRICE/EACH

CODE	SIZE (inches)	CASE PACK	PRICE/EACH	
			50+	1000+
310110 ___*	1.75 x 1.125 x .625	100	\$0.43	\$0.34
310210 ___	2.5 x 1.5 x .875	100	\$0.46	\$0.36
310320 ___	3 x 2.125 x 1	100	\$0.49	\$0.37
310330 ___	3.5 x 3.5 x 1	100	\$0.59	\$0.45
310360 ___	3.5 x 3.5 x 1.5	100	\$0.62	\$0.50
310340 ___	3.5 x 3.5 x 2	100	\$0.66	\$0.52
310530 ___	5.25 x 3.75 x .875	100	\$0.70	\$0.54
310650 ___	6 x 5 x 1	50	\$0.95	\$0.74
310820 ___	8 x 2 x .875	100	\$0.62	\$0.50
310850 ___*	8 x 5.5 x 1.25	50	\$1.26	\$0.99

FOIL PRINT
<500 - 20¢ each
>500 - 18¢ each

* These sizes are available in these colors only: 00K, 07, 15, 15P, 60, 75, 76.

All print orders subject to \$30 set-up charge. Applicable artwork, and plate charges may apply. See page 126.



Deliver the 'in-store' experience to your customer's door.

15B - Black

87B - Metallic Bronze

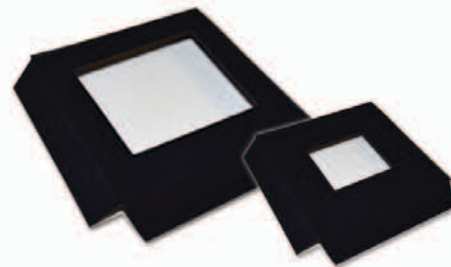

Black flock e-Comm Inserts

E-Commerce Jewelry Boxes

For Geo and Velocity Packaging

- Kraft boxes with black or metallic bronze interior
- Black flock inserts available to fit Geo or Velocity jewelry packaging*
- Reversible
- Minimum case pack 25

CODE	DESCRIPTION	SIZE (inches)	PRICE/EACH	
			25+	250+
450505 ___	Small	5.75 x 5.75 x 2.5	\$1.25	\$1.18
451010 ___	Large	10.25 x 10.25 x 2.5	\$2.50	\$2.30
Geo Inserts				
69221153G	Geo ring to fit small box		\$0.50	\$0.46
69283153G	Geo T-pad to fit small box		\$0.50	\$0.46
69293153G	Geo bracelet to fit large box		\$0.82	\$0.65
69273153G	Geo necklace to fit large box		\$0.82	\$0.65
Velocity Inserts				
69321153V	Velocity ring to fit small box		\$0.50	\$0.46
69383153V	Velocity utility pad to fit small box		\$0.50	\$0.46
69393153V	Velocity bracelet to fit large box		\$2.50	\$2.30
69373153V	Velocity necklace to fit large box		\$2.50	\$2.30

* Inserts can be special ordered to fit any of our other jewelry packaging collections.
Minimum order: 100 per size

FOIL PRINT
<500 - 20¢ each
>500 - 18¢ each

E-Commerce Gift Boxes

A Variety of Sizes for Gift Items

- Reversible kraft boxes with grey or light blue interior
- Minimum case pack 25

See page 106 for pricing details.



Diamond Presentation Box

- Black with black suedine interior.
- Drawer fits Diamond Certificate.

36800153

4" x 4" x 3"

\$4.99/ea. (36/case)

FOIL PRINT
<500 - 20¢ each
>500 - 18¢ each

PAD PRINT
Add your logo to the lid.
<500 is 22¢ each
>500 is 20¢ each

Three pads to choose from:



Ring (6 pack)
69800153R

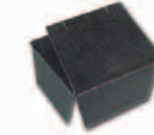

Earring (6 pack)
69800153P



Loose Diamond
Cup Pad (6 pack)
69800153S

Porcelain Trinket Box

- Size 2.5 x 2.5 x 1.062"
- Minimum case pack 60 porcelain boxes or minimum 50 pads

CODE	DESCRIPTION	CASE PACK	PRICE EACH 12+
36020200	Porcelain Box	60	\$.99
A 69020201	Pend/ring/earring pad	50	N/C*
B 69020202	Multi hoop pad	50	N/C*
C 69020203	Euro wire hoop pad	50	N/C*
D 69020204	Pend/multi studs pad	50	N/C*

* with purchase of boxes

Choice of 4 different utility pads in cream flocked foam

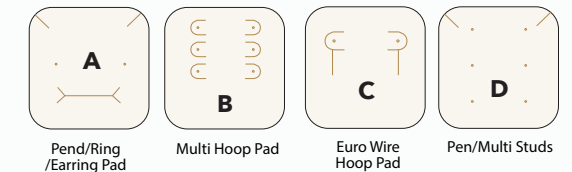

Pend/Ring/Earring Pad

Multi Hoop Pad

Euro Wire Hoop Pad

Pen/Multi Studs

FOIL PRINT
<500 - 20¢ each
>500 - 18¢ each



Allison

- Silver plate engravable ring, earring and pendant box is for special jewelry. Packed in kenized flannel pouch and black gift box.

36923990

1.75" x 1.75" x 2"

SPECIAL \$4.99/ea.

FOIL PRINT
Add your logo to the packer lid.
<500 - 20¢ each
>500 - 18¢ each



Gift Cards Not Included.

Black Gift Card Box with Ribbon

31040315

4 x 3 x .625

\$1.53 each (50+)

\$1.19 each (1000+)

Case packs of 100



FOIL PRINT
<500 - 20¢ each
>500 - 18¢ each

Minimum order is one case pack.
Applicable artwork, and plate charges may apply See page 126.

Pewter Gift Card Box with Ribbon

31040742

7.5 x 4.25 x .625

\$2.19 each (50+)

\$1.97 each (1000+)

Case packs of 50



FOIL PRINT
<500 - 20¢ each
>500 - 18¢ each

Minimum order is one case pack.
Applicable artwork, and plate charges may apply. See page 126.

Pillow Boxes

- Perfect for charms and beads
- Available in 2 colors and sizes
- Minimum 100 per size and color



FOIL PRINT
<500 - 20¢ each
>500 - 18¢ each

CODE	SIZE (inches)	CASE	PRICE/EACH	
			100+	1000+
A	32040309 - Red & White	4 x 3.75 x 1.75	100	\$0.26 \$0.21
B	32030209 - Red & White	3 x 2.5 x 1	100	\$0.20 \$0.16
C	32030215 - Black & White	3 x 2.5 x 1	100	\$0.20 \$0.16

Minimum order is one case pack.
Applicable artwork, and plate charges may apply. See page 126.

Salon or Spa Folder

CODE	SIZE (inches)	CASE	PRICE/EACH	
			100+	1000+
45060800	Space for Spa Menu and Gift Card	100	\$0.99	\$0.75

Finished and folded size: 6.875" x 8.5"



FOIL PRINT
<500 - 20¢ each
>500 - 18¢ each

Gift Certificate and Box

CODE	SIZE (inches)	PRICE/EACH	
		CASE	100+
09221001	Generic Gift Certificate with Ivory Box 6.625 x 3.25 x .5"	100	\$1.36
09221001B	Ivory Gift Certificate Box Only	100	\$0.82
18199	Generic Gift Certificate Only 6.375 x 3.125" folded	100	\$0.57



FOIL PRINT
<500 - 20¢ each
>500 - 18¢ each

Dress it up with printed ribbon!
See page 118.



Gift Card Box

- White paperboard platforms.
- Interior has same paper for lids and bases.

CODE	SIZE (inches)	CASE	PRICE/EACH
			100+
313230 __	3.5 x 2.25 x .75"	100	\$0.64

Gift Certificate and Box

CODE	SIZE (inches)	CASE	PRICE/EACH
			100+
0922100 _	Generic Gift Certificate with Box	100	\$1.36
0922100 _ B	Gift Certificate Box Only see color options 6.625 x 3.25 x .5"	100	\$0.82

Gift Certificate Box Color:



Minimum order is one case pack.



FOIL PRINT
<500 - 20¢ each
>500 - 18¢ each



PAD PRINT
Add your logo to the lid.
<500 is 22¢ each
>500 is 20¢ each



Interior of gift certificate shows printability and can be numbered.



Available to finish the look of your gift certificate/card.

Stretch Loops (100 pack min.)

- 09500607 **6"** - Gold **\$0.1224/ea**
- 09500608 **6"** - Silver **\$0.1224/ea**
- 09501007 **10"** - Gold **\$0.1308/ea**
- 09501008 **10"** - Silver **\$0.1308/ea**



Dress it up with printed ribbon!
See page 118.



Please allow 2 - 3 weeks for printed items from approved art.

IN STOCK

IN STOCK

Please allow 2 - 3 weeks for printed items from approved art.

Microfibre Pouches

• Minimum case pack 100

CODE	COLOR	SIZE (inches)	PRICE /EACH	
			100+	500+
09040315	Black	4 x 3	\$0.99	\$0.84
09050415	Black	5-1/2 x 4	\$1.39	\$1.19
09050412	Brown	5-1/2 x 4	\$1.39	\$1.19
09040311	Blue	4 x 3	\$0.99	\$0.84
09050411	Blue	5-1/2 x 4	\$1.39	\$1.19



Geo Pouches

Brushed ivory pouches with boxes that match our Geo hinged boxes on page 18.

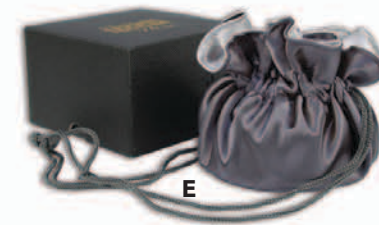

Reversible Satin Pouch

Foil print on top of the lid. Matching 2-piece printable outer box. Pouch has round base 2.75" dia. x 3" high



Microfibre Bell Pouches

Available in black only.



Damask Pouches

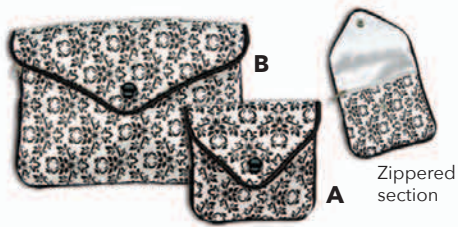

Envelope Pouches

w/Snap Closure
Available in black. Packaged in a two piece, pearlized, dark grey outer box.



Gold Metallic Pouch



White Leatherette Pouches



Velveteen Pouches



- Black - 615
- Royal Blue - 611
- Brown - 612
- Green - 667
- Burgundy - 666

See chart for 2-piece outer box for the Velveteen pouches.

Wedding Pouches



White satin pouch with a white 2 piece outer box.

CODE	TYPE	SIZE (inches)	PRICE /EACH	
			12+	144+
A 09030423C	Geo Pouch with Cobalt Box	3 x 4	\$1.88	\$1.58
B 09030415B	Geo Pouch with Black Box	3 x 4	\$1.88	\$1.58
C 09030456P	Geo Pouch with Purple Box	3 x 4	\$1.88	\$1.58
D 09030427T	Geo Pouch with Bronze Box	3 x 4	\$1.88	\$1.58
E 09020315B	Satin Reversible Pouch Charcoal/Silver with packer	2.75 x 3	\$2.34	\$1.99
F 09030381	Satin Reversible Pouch Blue/Silver without packer	2.75 x 3	\$1.99	\$1.49
G 09525115B	Large Microfibre Bell Pouch	5 x 5.75	\$1.08	\$0.92
H 09324115B	Small Microfibre Bell Pouch	3.25 x 4.5	\$0.82	\$0.71

• Minimum case pack of 12

• Minimum case pack of 100

CODE	TYPE	SIZE (inches)	PRICE /EACH	
			100+	1000+
A 09030315D	Small Damask Pouch	3 x 3	\$1.11	\$1.01
B 09040515D	Large Damask Pouch	5.5 x 4	\$1.52	\$1.32
C 09203715	Small Envelope Pouch	2.375 x 2.75	\$1.54	\$1.42
D 09304715	Large Envelope Pouch	3 x 4	\$1.99	\$1.89
E 09314807	Gold Metallic Pouch	3 x 4	\$0.55	\$0.43
F 09203700	Small White Leatherette Pouch	2.75 x 3.25	\$0.59	\$0.50
G 09314700	Large White Leatherette Pouch	3 x 4	\$0.48	\$0.42
H 09405 ___	*Velveteen Pouches	4 x 5.5	\$0.37	\$0.31
I 09314 ___	*Velveteen Pouches	3 x 4	\$0.45	\$0.37
31314003	White 2 piece outer box	3.25 x 4.25	\$0.46	-
31541003	White 2 piece outer box	4.5 x 6	\$0.52	-
J 37501006	White Wedding Pouches	1.875 x 2.5	\$1.84	\$1.54

* See photo for color code

Economical packaging for inexpensive items or repairs.

FOIL PRINT
<500 - 20¢ each
>500 - 18¢ each

PAD PRINT
Add your logo to the lid.
<500 is 22¢ each
>500 is 20¢ each

SPECIAL ORDER

Organza Pouches

Allow 2 - 3 Weeks for delivery. Can be foil printed.

Organza Colors Colors not exactly as shown.

Black - 030	Silver - 012	White - 029
Hunter - 589	Navy - 370	Smoke Blue - 337
Lt. Blue - 305	Burgundy - 276	Ultra Violet - 467
Purple - 465	Lavender - 430	Copper - 073
Orange - 750	Olive - 563	Mint - 530
Red - 250	Pink - 115	Gold - 690
Baby Maize - 617	Ivory - 810	Mauve - 161
Pastel Green - 513	Fruit Punch - 155	Yellow - 645
Turquoise - 340	Royal - 350	Fuchsia - 187

CODE	SIZE (inches)	PRICE /EACH	
		100+	1000+
A 09905 ___	2 x 2.5	\$0.29	\$0.23
B 09910 ___	3 x 4	\$0.32	\$0.24
C 09915 ___	4 x 5.5	\$0.41	\$0.33
D 09920 ___	5 x 6.5	\$0.46	\$0.37
E 09925 ___	5.5 x 9	\$0.68	\$0.55
F 09930 ___	6 x 14	\$0.79	\$0.63
09950 ___	22 x 25 (not shown)	\$2.68	\$2.14

Minimum 100 per size/color.

FOIL PRINT
<500 - 20¢ each
>500 - 18¢ each

A is only available in Silver, White, Pink, Lavender, Gold and Ivory.

F not available in Fruit Punch, Orange, Royal, Turquoise and Yellow.

G is only available in Silver, White, Pink, Red, Burgundy, Lt. Blue, Royal, Lavender, Mint, Olive, Gold and Ivory.



All print orders subject to \$30 set-up charge. Applicable artwork, and plate charges may apply. See page 126.

All print orders subject to \$30 set-up charge. Applicable artwork, and plate charges may apply. See page 126.

Cleaning Supplies



Blitz™ - Ultra Sonic Machine with non toxic Gem & Jewelry concentrate and microfibre polishing cloth. Single tank, battery operated unit (4 AA batteries not included). Place jewelry in baskets and immerse into tank, switch on for a 3 - 5 minute cleaning.

Ideal for cleaning Gold, Platinum, Diamonds, Ruby, Sapphire, Topaz, Amethyst, Aquamarine, Garnet, Peridot and other non-porous gems and non glued gems.

04201600 \$29.00 each



Blitz™ - Ultra Sonic Machine Gem & Jewelry Concentrate

Non toxic. Ideal for cleaning Gold, Platinum, Diamonds, Ruby, Sapphire, Topaz,

Amethyst, Aquamarine, Garnet, Peridot and other non-porous gems and non glued gems.

04201600C \$1.39 each

Minimum order is 12 pieces.



Gem & Jewelry Cleaner is ideal for cleaning Gold, Platinum, Diamonds, Ruby, Sapphire, Topaz, Amethyst, Aquamarine, Garnet, Peridot and other non-porous gems.

24 per case pack
04651000 \$1.75 each
8 oz.



Foamz™ is the same Gem and Jewelry Cleaner that you have used and trusted for decades in an easy-to-use foam. Foamz™ is formulated to clean and restore Diamonds and other precious gemstone jewelry to their original brilliance.

12 per case pack
04657000 \$3.95 each
2.5 oz.



Silver Shine is designed to remove tarnish from silver jewelry in seconds by utilizing a revolutionary new electrochemical process and is packaged in a wide mouth jar to easily clean larger pieces of silver jewelry.

12 per case pack
04681000
\$3.95 each
3 trays



Silver Care Polish traditional, non-abrasive, silver polishing cream

12 per case pack
04618000
\$6.25 each
236 ml



Delicate Gem & Pearl Cleaner is formulated to gently clean and restore the luster to Emerald, Ivory, Onyx, Opal, Pearl, Turquoise, Lapis, Coral, Malachite and other porous gems.

24 per case pack
04671000 \$1.75 each
8 oz.



Watch Care Kit cleans and polishes all watches and bands (gold, silver, stainless steel or leather).

12 per case pack
04620462 \$9.95/ea



Jewelry Care Cloth 11" x 14" two ply cloth made from 100% soft cotton. The interior is thoroughly treated with the finest cleaning and polishing agents with tarnish inhibitors to clean, shine and protect.

12 per case pack
04961700 Jewelry Care
\$3.95/ea

04961800 Silver Care
\$3.95/ea



Gem & Jewelry Cleaner Concentrate

A) One gallon 10:1
04654000 \$17.95/ea

B) 8 fl. oz. 5:1
04653000 \$2.95/ea



Handling Gloves

White microfibre
One size fits all

The natural oils in our skin can often leave displeasing marks on jewelry. Our microfibre, lint-free gloves are ideal for handling and protecting your most precious inventory.

05000296
\$2.50/pair
minimum order - 6 pairs



Non-toxic and effective for everyday use.

Buy 144 and we'll customize for **FREE!**

Metallic gold and silver is limited to printing on black, blue, green, brown, violet and wine backgrounds.



Vellum Enveloped Cleaning Cloths



Full Color Printed Labels

Choose from print colors below or create your own full color look. Please allow 6 - 8 weeks for custom printed items from approved art. Minimum order is 144 jars.

Customize with your store brand!
144 - 236ml Jars for just \$1.85 each

CODE	DESCRIPTION	PRICE/EACH 144+
04651000C	Private Label Gem Jewel Cleaner	\$1.85

LABEL COLORS:



PRINT COLORS:



Full Color Microfibre Cleaning Cloths

• Please allow 6 - 8 weeks for printed items from approved art.
• Minimum order is 2500 cloths.

04060800C
6" x 8"
\$1.24/ea. (2500+) **\$0.93/ea.** (5000+)

Customizable Jewelry Care Cloths

Please allow 4 - 6 weeks for custom printed cloths. Minimum Order is 144 cloths.

CODE	SIZE (inches)	PRICE
04966800C	6 x 8 (envelope)	\$1.55/ea
04981000C	8 x 10 (poly bag)	\$1.95/ea
04912150C	12 x 15 (poly bag)	\$2.99/ea
04961700C	11 x 14 (boxed)	\$3.95/ea

PRINT COLORS:



Light Blue Diamond & Gem Cloths

Please allow 4 - 6 weeks for custom printed cloths from approved art. Minimum Order is 144 cloths.

04780800C | 8 x 8" Blue cloth | \$2.00/ea

Microfibre Cloth removes small dust, oily film, fingerprints and other residue from fine jewelry. Chemical Free. Lint Free. AVAILABLE IN LIGHT BLUE ONLY.

Repair Envelopes

 **NO PLATE CHARGES!**

CODE	DESCRIPTION	SIZE (inches)	PRICE/EACH			
			1000	3000	5000	10000
A 09850000	2-Part NCR	4.25 x 9	\$0.20	\$0.19	\$0.17	\$0.145
B 09845200	Plain-no perf., text or numbers	3.5 x 6.125	\$0.57	\$0.54	\$0.50	\$0.49
C 09845300	Double Perforated	3.5 x 6.125	\$0.137	\$0.105	\$0.10	\$0.095
D 09845400	Single Perforated	3.5 x 6.125	\$0.137	\$0.105	\$0.10	\$0.095

• Prices include one color printing. A second color is \$ 0.029/each.
Minimum 1000 per style. Printing colors: Black, Red, Green and Blue



Please allow 2 - 3 weeks for printing.
\$30 set-up charge applies.

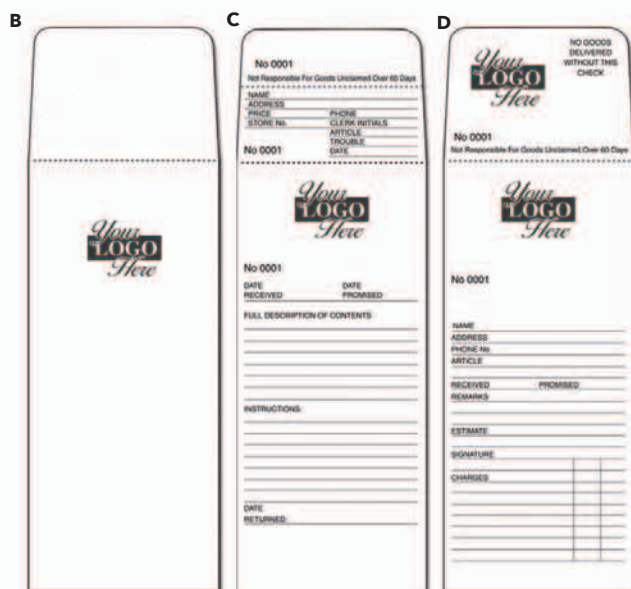

Tags and Miscellaneous Accessories

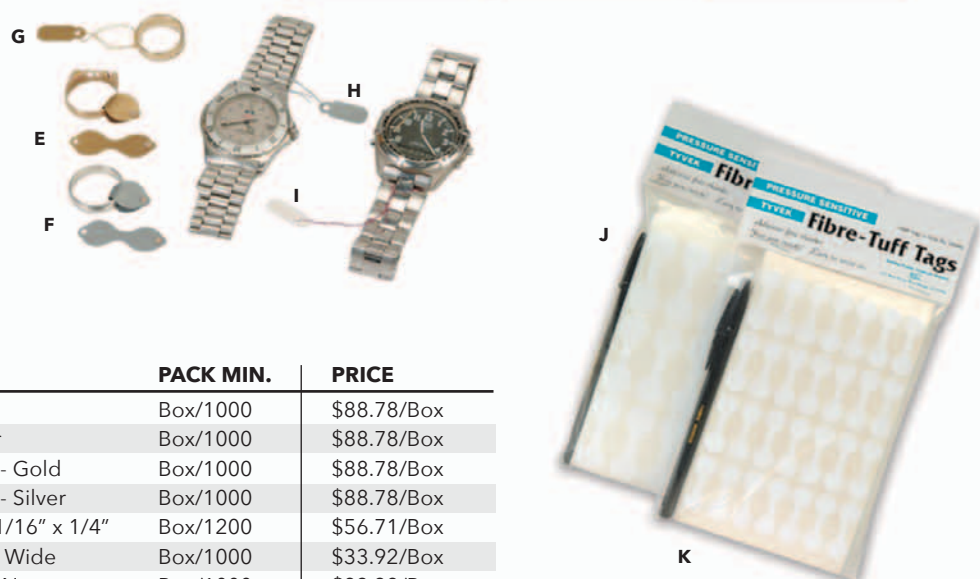

CODE	DESCRIPTION	PACK MIN.	PRICE
E 08270207	Plastic Ring Tags - Gold	Box/1000	\$88.78/Box
F 08270208	Plastic Ring Tags - Silver	Box/1000	\$88.78/Box
G 08090707	Plastic With String Tags - Gold	Box/1000	\$88.78/Box
H 08090708	Plastic With String Tags - Silver	Box/1000	\$88.78/Box
I 08008400	Jewelry String Tags - 11/16" x 1/4"	Box/1200	\$56.71/Box
J 08810800	Super Mylar Ring Tags - Wide	Box/1000	\$33.92/Box
K 08810700	Super Mylar Ring tags - Narrow	Box/1000	\$23.32/Box
08833000	Fine Pen Marker (not shown)	1	\$9.81/each - not shown

Available for immediate shipping for above items.

All print orders subject to \$30 set-up charge. Applicable artwork, and plate charges may apply. See page 126.

CREATE Your Own Look Jewelry Packaging



SPECIALTY SERIES

A truly custom program. Round corner shell covered in aubergine linea and a matching aubergine shimmer interior. The top of each box is embossed with a foil stamped logo and the pièce de resistance - an engraved badge closure. The collection includes unique items such as the ring roll and a pearl folder encased in a traditional necklace box. Packaged in a contrasting ¾ depth outer box with similar aubergine printing on top.

Create Your Own Look Program.

Its easy to create a look that is truly unique for your brand. Pages 43 through 59 will inspire you to design and develop a custom jewelry packaging program that is just right for your store.

We understand that having the perfect package is just as important as having the perfect piece; we've put 100's of options at your finger tips . . .

The possibilities are truly endless!
Follow these 6 simple steps to create the jewelry packaging program you've always wanted!

- 1) Select a box style
- 2) Choose colors
- 3) Choose materials
- 4) Select your size assortment
- 5) Select your interior pads
- 6) Send us your artwork

CREATE

Your Own Look Jewelry Packaging

WOODEN SERIES

The possibilities are endless when you choose wooden materials. The possibilities are endless in terms of size, shape, finish and color. This collection offers a natural wood finish with cream leatherette interior and a green logo on the top liner. The traditional outer box is cream leatherette with a green printed lid. The collection is complete with a matching rope-handle tote and coordinating tissue.

Wooden Create Your Own Look Programs start as low as: \$6.80 for the ring box



This collection includes:

- Ring box with R1 Ring Pad
- Pendant earring box with ET14 T-Pad Earring/Pendant
- Earring box with E4 Slits Earring pad
- Bracelet box with BL1R Removable Pad with Metal Clips
- Traditional Necklace box with N1 Removable Necklace Pad
- Watch box with PL1 pillow/bracelet

CREATE

Your Own Look Jewelry Packaging



REVEAL SERIES

This reveal series offers a contemporary look and countless ways to make it even more unique with your own colors, fabrics and interiors. This collection features a black corvon paper covering with a contrasting light blue sleeve interior. White leatherette interiors include a two-color logo on the top liner. This collection is completed with a coordinating leatherette pouch and euro-tote with satin ribbon handle.

Reveal Create Your Own Look Programs starts as low as: \$6.69 for the ring box

This collection includes:

- Ring box with R2 Ring Clip
- Earring box with E3 Earring Pad
- Pendant earring box with EP4 Earring/Pendant Pad
- Watch box with custom W1 Metal Watch Collar
- Bracelet box with BL1R Removable Pad with Metal Clips
- Shallow Necklace box with Removable Pad with Clips



CREATE

Your Own Look Jewelry Packaging



ECLIPSE SERIES

This eclipse collection features an elegant champagne linea covering with an ivory shimmer interior and gold printed logo on the top liner. The crisp white full depth outer box and gold rope handle tote complete this beautiful collection.

Eclipse Create Your Own Look Programs starts as low as: \$4.68 for the ring box

The Charm collection includes:

- Ring box with R1 Ring Slot Pad
- Pendant earring box with EP4 Earring/Pendant Pad
- Pendant box with P5 Die Cut Pendant Pad
- Watch/Bracelet box with PL1 Pillow



CREATE

Your Own Look Jewelry Packaging



The Foster collection includes:

- Ring box with R1 Ring Pad
- Pendant earring box with EP4 Earring/Pendant Pad
- Earring box with ET14 T-pad
- Watch/Bracelet box with PL1 Pillow
- Bracelet box with BL1R Removable Pad with Metal Clips
- Traditional Necklace box with N1 Removable Necklace Pad

GEO SERIES

Making a series completely unique can be as simple as adding some top-stitching to the covering and upgrading the fabric to a luxurious grey leatherette. This Geo collection features an embossed logo on the top of the lid. Matching dark interior pads create a seamless look to showcase fine pieces. Packaged in two-tone ¾ depth outer box with a silver embossed print. The collection is completed with coordinating leatherette pouches and custom rope handle totes.

Geo Create Your Own Look Programs starts as low as: \$3.86 for the ring box

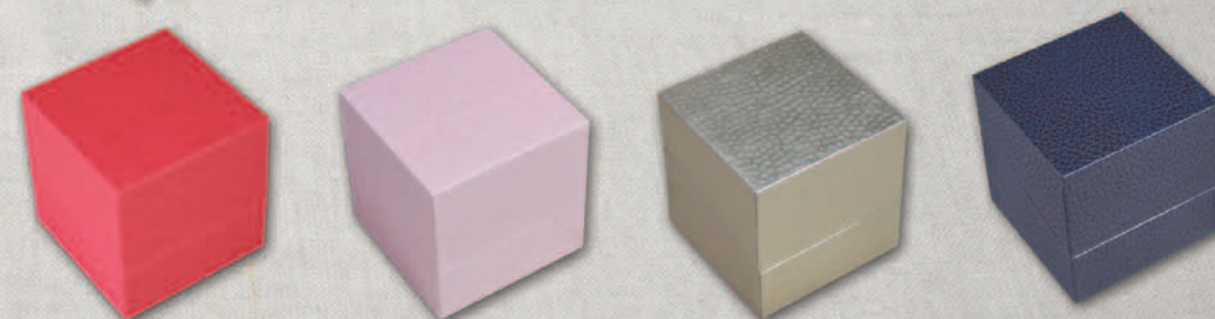

CREATE

Your Own Look Jewelry Packaging

The Romm collection includes:

- Ring box with R1 Ring Pad
- Pendant earring box with EP4 Earring/Pendant Pad
- Double Ring box with extended R1 Ring Pad
- Pendant box with P3 Pendant Pad
- Bracelet box with BL1R Removable Pad with Clips



ROMA SERIES

Customizing a series can be simple yet extensive as shown in this collection. This look combines a blue lizard pattern covering with silver logo on the exterior and a coordinating blue velour interior. A custom bag and ribbon was added to coordinate with this collection.

Roma Create Your Own Look Programs starts as low as: \$4.27 for the ring box



CREATE

Your Own Look Jewelry Packaging



ELAN SERIES

This collection features a classic design in orange nabuka covering with an off-white leatherette interior with printed logo on the top liner. Offering a pearl folder in place of the hinged box is an alternative option. Matching outer boxes with printed lids rounds out the collection nicely.

Elan Create Your Own Look Programs starts as low as: \$3.17 for the ring box

The Ring Master collection includes:

- Ring box with R1 Ring Pad
- Pendant earring box with EP4 Earring/Pendant Pad
- Double Ring box with extended R1 Ring Pad
- Bracelet box with BL1R Removable Pad with Metal Clips
- Pearl Folder



CREATE

Your Own Look Jewelry Packaging



VANTAGE SERIES

This luxurious collection is covered in brown aged leatherette and features a white satin interior with a printed logo on the top liner. The inverted trapezoid rope handle tote, matching silver tissue and coordinating printed outer box, completes the elegant look of this collection.

Vantage Create Your Own Look Programs starts as low as: \$3.78 for the ring box

The Oshawa Jewelry collection includes:

- Ring box with R1 Ring Pad
- Large Pendant earring box with EP4 Earring/Pendant Pad
- Small Pendant earring box with EP4 Earring/Pendant Pad
- Double Ring box with extended R1 Ring Pad
- Bangle box
- Watch/Bracelet outer box with PL1 Pillow (no hinged box)
- Bracelet box with BL1R Removable Pad with Metal Clips
- Necklace outer box with Pearl Folder

CREATE
Your Own Look Jewelry Packaging



The Act II collection includes:

- Ring box with an R2 ring clip pad
- Pendant earring box with EP4 Earring/Pendant Pad
- Bangle box
- Bracelet Box with BL1R Removable Pad with Metal Clips
- Necklace Box with NI Removable Pad

HORIZON SERIES

This collection features a contemporary black leatherette covering with an soft ivory interior. The silver mod tote complements this sophisticated look.

Horizon Create Your Own Look Programs starts as low as: \$2.44 for the ring box

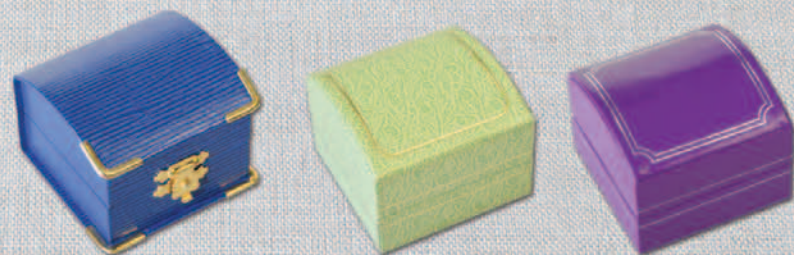

CREATE
Your Own Look Jewelry Packaging



ESTATE SERIES

This collection features red leatherette with accenting gold pinstripes and a coordinating clasp. These hinged boxes open to reveal white velour pads with a printed top liner. Each box is packed in a coordinating red outer box. Completing this collection with a matching red rope handle tote with gold rope handle and custom tissue.

Estate Create Your Own Look Programs starts as low as: \$4.51 for the ring box



The Becker's collection includes:

- Ring box with R1 Ring pad
- Pendant earring box with EP4 Earring/Pendant Pad
- Double Ring box with extended R1 Ring Pad
- Watch/Bracelet box with PL1 Pillow
- Bracelet box with BL1R Removable Pad with Metal Clips
- Shallow Necklace box with N1 Removable Pad with Metal Clips
- Traditional Necklace box with N1 Removable Necklace Pad

CREATE

Your Own Look Jewelry Packaging



PAPERBOARD SERIES

For a more economical packaging solution, paperboard offers a limitless variety of styles, patterns, colors and pads. A custom paperboard collection can be created to complement your existing higher-end hinged packaging program. The collections on this page show only a small sample of the possibilities.

Create Your Own Look Paperboard Series Programs start at \$1.89 for the ring box

CREATE

Your Own Look Jewelry Packaging

Choose Your Box Style:

Select one of the box styles that suits your brand image or show us a style that inspires you.



Wood

Reveal

Eclipse



Geo

Vantage

Roma

Elan

Horizon

Estate

Paperboard

Choose Your Colors:

You can select from 100+ colors for your boxes.

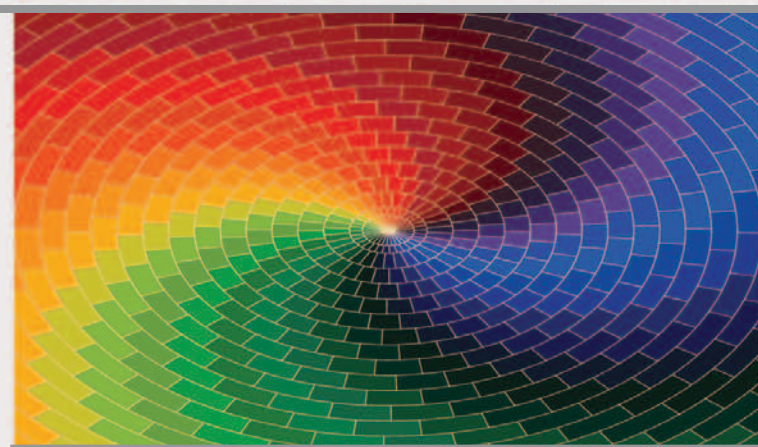

Choose The Material:

You can select from 50+ materials for your boxes. Now's your chance to get just what you are looking for - Be creative!



Level 1 - Papers



Level 3 - Textured Leatherette



Level 2 - Leatherette



Level 4 - Suedine, Velvet and Silk Leatherette

Not all materials can wrap all boxes. Check with your sales rep for more information.

Send Us Your Artwork!

Don't forget to consider size of print when you are deciding on your print boxes. Will you prefer to print the same size on all of the boxes or have a larger print on the necklace and bracelet boxes? Also consider: will you print only on the top satin or will you print the outside outer box as well? Take special note of programs that offer additional printing opportunities such as printing on the top of the actual box or printing onto ribbon. (Art charges may apply \$70.00/hour)

Contact your sales representative or call our toll free number to place your order.

See back cover of our catalog for complete listing of contact information.

Custom Box Pad Styles



Select Your Interior Pads:

For each size of box, you can select your preference of interior pad. Perhaps you prefer a T-pad to a standard earring flap? Choose from 22 different interior pad options.

The Vantage Series
IN STOCK
WINDOW AND
SHOWCASE
DISPLAYS

Platforms, Risers, Trays and
Matching Jewelry Stands.
Available in Chalk Vienna
Leatherette



In Stock Window Display (VAN-SC-WIN-KIT-SC as pictured above) consists of:

- | | | | |
|------------------------|---------------------|-------------------------|---------------|
| (1) DAWS02-SC | Window platform set | (2) DA80060UR-SC | Ring stand |
| (1) DADB225-SC | Bracelet arch | (2) DA80059UR-SC | Ring stand |
| (1) DAJP350V-SC | Bangle pillow | (1) DA321S-SC | Signage block |
| (2) DACES12-SC | Earring stands | (3) DARF110-SC | Ring fingers |
| (1) DACES32-SC | Earring stand | (1) DANF1022-SC | Neck form |
| (1) DACH01-SC | Single hoop earring | (1) DANF1020-SC | Neck form |
| (2) DA350P-SC | Pendant stand | | |
| (2) DA225P-SC | Pendant stand | | |

\$499.00 /as shown

Save 25% when you buy \$500 or more!

Item	Part No. / Description	Price/ea.	Item	Part No. / Description	Price/ea.
	DA80P01-SC Platform 12 x 10 x .875"	\$34.61 BUY \$500+ \$25.96		DA80P03-SC Platform 10 x 5 x 1.75"	\$33.06 BUY \$500+ \$24.80
	DA80P02-SC Platform 11 x 7.5 x 1.875"	\$35.65 BUY \$500+ \$26.74		DA80332-SC Riser 3 x 3 x 2"	\$9.60 BUY \$500+ \$7.20
	DA80662-SC Riser 6 x 6 x 2"	\$22.92 BUY \$500+ \$17.19			

* Platform floorboards are not included in the price. Material for covering your own floorboards is available and is priced by the yard. See page 72.

Platform layout suggestions



Total price does not include applicable taxes. Only available in VANTAGE Chalk Vienna fabric options.

Ring Showcase Display

Available for immediate shipment.

IN STOCK

IN STOCK

Ring Showcase Display

Available for immediate shipment.

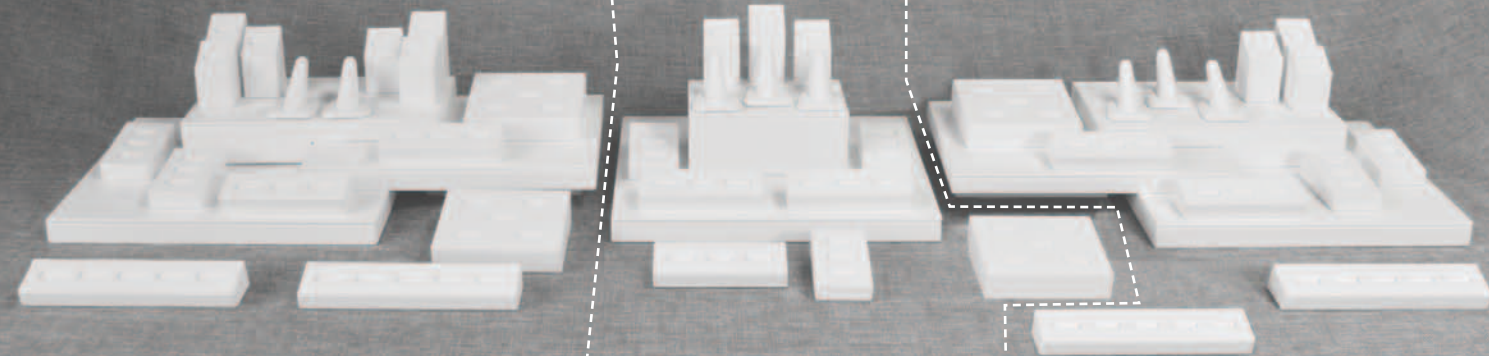

Section 1

Section 2

Section 3

16 sku capacity - 40 Rings
\$174.12*

*Platforms not included

-  Ring Stand
2.875 x 2.625 x 1.875"
DARF110-SC (2) \$6.25 ea.
-  Ring Stands
1.625 x 1.5 x 2.125"
DA80058UR-SC (2) \$7.93 ea.
-  Ring Stands
1.625 x 1.5 x 2.5"
DA80059UR-SC (2) \$8.00 ea.
-  Ring Stands
1.625 x 1.5 x 2.75"
DA80060UR-SC (2) \$8.10 ea.
-  3 Ring Horizontal Bar
4.5 x 1.625 x 1"
DA8003RH-SC (2) \$12.01 ea.
-  3 Ring Vertical Bar
1.75 x 3 x 1"
DA8003RV-SC (2) \$11.19 ea.
-  5 Universal Ring Tray
6.75 x 2.25 x 1.5"
DA28C05UR-SC (2) \$14.39 ea.
-  5 Universal Ring Tray
4.625 x 4 x 1.5"
DA28D05UR-SC (2) \$19.19 ea.
-  Platform 10 x 5 x 1.75"
DA80P03-SC (1) \$33.06 ea.
-  Platform 11 x 7.5 x 1.875"
DA80P02-SC (1) \$35.65 ea.
-  Platform 12 x 10 x 7/8"
DA80P01-SC (1) \$34.61 ea.

12 sku capacity - 29 Rings
\$150.76*

*Platforms not included

-  Ring Stand
2.875 x 2.625 x 1.875"
DARF110-SC (3) \$6.25 ea.
-  Ring Stands
1.625 x 1.5 x 2.125"
DA80058UR-SC (1) \$7.93 ea.
-  Ring Stands
1.625 x 1.5 x 2.5"
DA80059UR-SC (1) \$8.00 ea.
-  Ring Stands
1.625 x 1.5 x 2.75"
DA80060UR-SC (1) \$8.10 ea.
-  3 Ring Horizontal Bar
4.5 x 1.625 x 1"
DA8003RH-SC (3) \$12.01 ea.
-  3 Ring Vertical Bar
1.75 x 3 x 1"
DA8003RV-SC (3) \$11.19 ea.
-  5 Universal Ring Tray
6.75 x 2.25 x 1.5"
DA28C05UR-SC (2) \$14.39 ea.
-  5 Universal Ring Tray
4.625 x 4 x 1.5"
DA28D05UR-SC (2) \$19.19 ea.
-  Platform 6 x 6 x 2"
DA80662-SC (1) \$36.97 ea.
-  Platform 11 x 7.5 x 1.875"
DA80P02-SC (1) \$35.65 ea.
-  Platform 12 x 10 x 7/8"
DA80P01-SC (1) \$34.61 ea.

14 sku capacity - 33 Rings
\$137.15*

*Platforms not included

-  Ring Stand
2.875 x 2.625 x 1.875"
DARF110-SC (3) \$6.25 ea.
-  Ring Stands
1.625 x 1.5 x 2.125"
DA80058UR-SC (1) \$7.93 ea.
-  Ring Stands
1.625 x 1.5 x 2.5"
DA80059UR-SC (1) \$8.00 ea.
-  Ring Stands
1.625 x 1.5 x 2.75"
DA80060UR-SC (1) \$8.10 ea.
-  3 Ring Horizontal Bar
4.5 x 1.625 x 1"
DA8003RH-SC (2) \$12.01 ea.
-  3 Ring Vertical Bar
1.75 x 3 x 1"
DA8003RV-SC (2) \$11.19 ea.
-  5 Universal Ring Tray
6.75 x 2.25 x 1.5"
DA28C05UR-SC (2) \$14.39 ea.
-  5 Universal Ring Tray
4.625 x 4 x 1.5"
DA28D05UR-SC (1) \$19.19 ea.
-  Platform 10 x 5 x 1.75"
DA80P03-SC (1) \$33.06 ea.
-  Platform 11 x 7.5 x 1.875"
DA80P02-SC (1) \$35.65 ea.
-  Platform 12 x 10 x 7/8"
DA80P01-SC (1) \$34.61 ea.

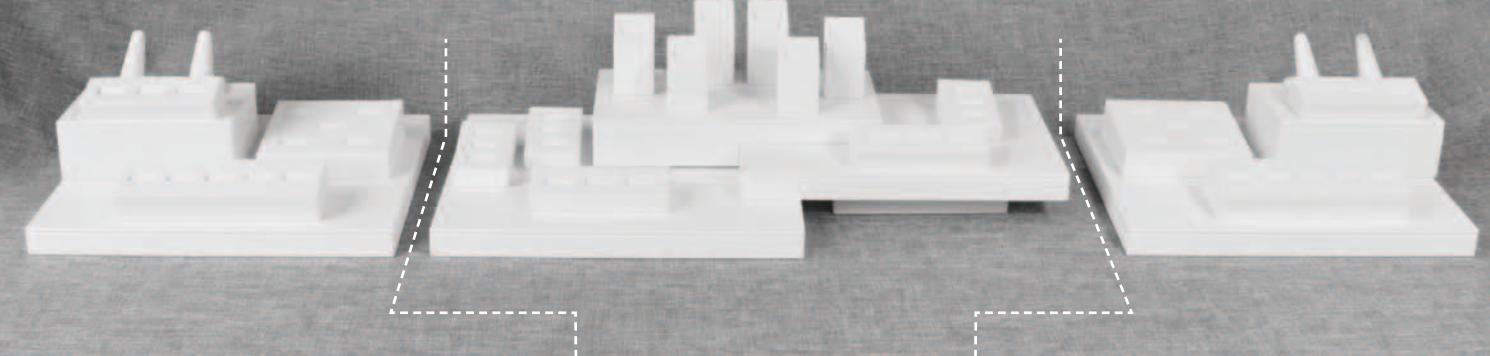







Section 1

Section 2

Section 3









5 sku capacity - 15 Rings
\$58.09*

*Platforms not included

-  Ring Stand
2.875 x 2.625 x 1.875"
DARF110-SC (2) \$6.25 ea.
-  3 Ring Horizontal Bar
4.5 x 1.625 x 1"
DA8003RH=SC (1) \$12.01 ea.
-  5 Universal Ring Tray
6.75 x 2.25 x 1.5"
DA28C05UR-SC (1) \$14.39 ea.
-  5 Universal Ring Tray
4.625 x 4 x 1.5"
DA28D05UR-SC (1) \$19.19 ea.
-  Platform 6 x 6 x 2"
DA80662-SC (1) \$36.97 ea.
-  Platform 12 x 10 x 7/8"
DA80P01-SC (1) \$34.61 ea.







11 sku capacity - 21 Rings
\$177.66*

*Platforms not included

-  Ring Stands
1.625 x 1.5 x 2.125"
DA80058UR-SC (2) \$7.93 ea.
-  Ring Stands
1.625 x 1.5 x 2.5"
DA80059UR-SC (2) \$8.00 ea.
-  Ring Stands
1.625 x 1.5 x 2.75"
DA80060UR-SC (2) \$8.10 ea.
-  3 Ring Horizontal Bar
4.5 x 1.625 x 1"
DA8003RH-SC (2) \$12.01 ea.
-  3 Ring Vertical Bar
1.75 x 3 x 1"
DA8003RV-SC (3) \$11.19 ea.
-  Platform 10 x 5 x 1.75"
DA80P03-SC (1) \$33.06 ea.
-  Platform 11 x 7.5 x 1.875"
DA80P02-SC (1) \$35.65 ea.
-  Platform 12 x 10 x 7/8"
DA80P01-SC (1) \$34.61 ea.

5 sku capacity - 15 Rings
\$58.09*

*Platforms not included

-  Ring Stand
2.875 x 2.625 x 1.875"
DARF110-SC (2) \$6.25 ea.
-  3 Ring Horizontal Bar
4.5 x 1.625 x 1"
DA8003RH-SC (1) \$12.01 ea.
-  5 Universal Ring Tray
6.75 x 2.25 x 1.5"
DA28C05UR-SC (1) \$14.39 ea.
-  5 Universal Ring Tray
4.625 x 4 x 1.5"
DA28D05UR-SC (1) \$19.19 ea.
-  Platform 6 x 6 x 2"
DA80662-SC (1) \$36.97 ea.
-  Platform 12 x 10 x 7/8"
DA80P01-SC (1) \$34.61 ea.

This complete 6 foot - 102 ring element display - \$462.03

Buy \$500+ \$346.52

Add all platforms as shown - \$278.22

Buy \$500+ \$208.66

This complete 5 foot - 51 ring element display - \$233.84

Buy \$500+ \$175.38

Add all platforms as shown - \$246.48

Buy \$500+ \$184.86

Total price does not include applicable taxes. Only available in Chalk Vienna Leatherette.

Total price does not include applicable taxes. Only available in Chalk Vienna Leatherette.

Pendant/Earring Showcase Display

Available for immediate shipment.

IN STOCK

IN STOCK

Mix Element Showcase Display

Available for immediate shipment.

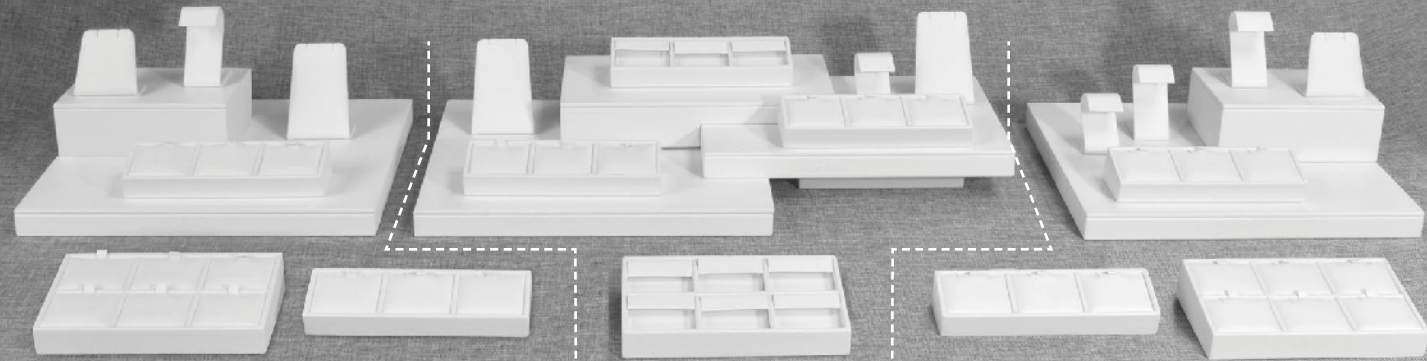

Section 1

Section 2

Section 3

15 sku capacity - 5 Pendants, 10 Earrings

\$86.00*

*Platforms not included

Earring Stand
2.375 x 2.375 x 2.875"
DACES13-SC (1) \$7.95 ea.

Pendant Stand
2.375 x 2.25 x 2"
DA225P-SC (1) \$6.40 ea.

Pendant Stand
2.375 x 2.375 x 2.675"
DA350P-SC (1) \$8.00 ea.

3 Pendant Tray
6.75 x 2.25 x 1.5"
DA28C03PD-SC (1) \$19.19 ea.

3 Pierced Earring Tray
6.75 x 2.25 x 1.5"
DA28C03PE-SC (1) \$17.27 ea.

6 Pierced Earring Tray
6.75 x 4 x 1.5"
DA28E06PE-SC (1) \$27.19 ea.

Platform 6 x 6 x 2"
DA80662-SC (1) \$22.95 ea.

Platform 12 x 10 x 7/8"
DA80P01-SC (1) \$34.61 ea.

18 sku capacity - 5 Pendants, 13 Earrings

\$105.19*

*Platforms not included

Earring Stand
2.375 x 2.375 x 2.125"
DACES12-SC (1) \$7.95 ea.

Pendant Stand
2.375 x 2.375 x 2.675"
DA350P-SC (2) \$8.00 ea.

3 Pendant Tray
6.75 x 2.25 x 1.5"
DA28C03PD-SC (1) \$19.19 ea.

3 Flap Earring Tray
6.75 x 2.25 x 1.5"
DA28C03FE-SC (1) \$15.99 ea.

3 Pierced Earring Tray
6.75 x 2.25 x 1.5"
DA28C03PE-SC (1) \$17.27 ea.

6 Flap Earring Tray
6.75 x 4 x 1.5"
DA28E06FE-SC (1) \$28.79 ea.

Platform 10 x 5 x 1.75"
DA80P03-SC (1) \$33.06 ea.

Platform 11 x 7.5 x 1.875"
DA80P02-SC (1) \$35.65 ea.

Platform 12 x 10 x 7/8"
DA80P01-SC (1) \$34.61 ea.

16 sku capacity - 13 Pendants, 3 Earrings

\$95.82*

*Platforms not included

Earring Stand
2.375 x 2.375 x 2.125"
DACES12-SC (1) \$7.95 ea.

Earring Stand
2.375 x 2.375 x 2.875"
DACES13-SC (2) \$7.95 ea.

Pendant Stand
2.375 x 2.25 x 2"
DA225P-SC (1) \$6.40 ea.

3 Pendant Tray
6.75 x 2.25 x 1.5"
DA28C03PD-SC (2) \$19.19 ea.

6 Pendant Tray
6.75 x 4 x 1.5"
DA28E06PD-SC (1) \$27.19 ea.

Platform 6 x 6 x 2"
DA80662-SC (1) \$22.92 ea.

Platform 12 x 10 x 7/8"
DA80P01-SC (1) \$34.61 ea.



Section 1

Section 2

Section 3

13 sku capacity - 1 Ring, 8 Pendants, 4 Earrings

\$87.06*

*Platforms not included

Ring Stand
2.875 x 2.625 x 1.875"
DARF110-SC (1) \$6.25 ea.

Pendant Stand
2.375 x 2.25 x 2"
DA225P-SC (1) \$6.40 ea.

Earring Stand
2.375 x 2.375 x 2.875"
DACES13-SC (1) \$7.95 ea.

3 Pierced Earring Tray
6.75 x 2.25 x 1.5"
DA28C03PE-SC (1) \$17.27 ea.

6 Pendant Tray
6.75 x 4 x 1.5"
DA28E06PD-SC (1) \$27.19 ea.

Neckform
6.5 x 4.5 x 4"
DANF1026-SC (1) \$22.00 ea.

Platform 6 x 6 x 2"
DA80662-SC (1) \$36.97 ea.

Platform 12 x 10 x 7/8"
DA80P01-SC (1) \$34.61 ea.

24 sku capacity - 20 Rings, 4 Pendants

\$136.79*

*Platforms not included

Ring Stand
2.875 x 2.625 x 1.875"
DARF110-SC (4) \$6.25 ea.

3 Ring Horizontal Bar
1.75 x 3 x 1"
DA8003RH-SC (2) \$12.01 ea.

3 Pendant Tray
6.75 x 2.25 x 1.5"
DA28C03PD (1) \$19.19 ea.

5 Universal Ring Tray
6.75 x 2.25 x 1.5"
DA28C05UR-SC (1) \$14.39 ea.

5 Universal Ring Tray
4.625 x 4 x 1.5"
DA28D05UR-SC (1) \$19.19 ea.

Neckform
6.5 x 4.5 x 8"
DANF1028-SC (1) \$35.00 ea.

Platform 10 x 5 x 1.75"
DA80P03-SC (1) \$33.06 ea.

Platform 11 x 7.5 x 1.875"
DA80P02-SC (1) \$35.65 ea.

Platform 12 x 10 x 7/8"
DA80P01-SC (1) \$34.61 ea.

13 sku capacity - 1 Ring, 2 Pendants, 10 Earrings

\$90.26*

*Platforms not included

Ring Stand
2.875 x 2.625 x 1.875"
DARF110-SC (1) \$6.25 ea.

Pendant Stand
2.375 x 2.375 x 2.675"
DA350P-SC (1) \$8.00 ea.

Earring Stand
2.375 x 2.375 x 2.125"
DACES12-SC (1) \$7.95 ea.

3 Pierced Earring Tray
6.75 x 2.25 x 1.5"
DA28C03PE-SC (1) \$17.27 ea.

6 Flap Earring Tray
6.75 x 4 x 1.5"
DA28E06FE-SC (1) \$28.79 ea.

Neckform
6.5 x 4.5 x 4"
DANF1026-SC (1) \$22.00 ea.

Platform 6 x 6 x 2"
DA80662-SC (1) \$36.97 ea.

Platform 12 x 10 x 7/8"
DA80P01-SC (1) \$34.61 ea.

This complete 5 foot - 50 pendant/earring element display - \$287.01

Buy \$500+ \$215.25

Add all platforms as shown - \$246.48

Buy \$500+ \$184.86

This complete 5 foot - 50 mix element display - \$314.11

Buy \$500+ \$235.58

Add all platforms as shown - \$246.48

Buy \$500+ \$184.86









Total price does not include applicable taxes. Only available in Chalk Vienna Leatherette.







Total price does not include applicable taxes. Only available in Chalk Vienna Leatherette.

Save 25% when you buy \$500 or more!

Item	Part No. / Description	Price/ea.	Item	Part No. / Description	Price/ea.
	DA80058UR-SC Ring stand 1 5/8 x 1 1/2 x 2 1/8"	\$7.93 BUY \$500+ \$5.94		DA80070S-SC Ring stand set	\$39.00 BUY \$500+ \$29.25
	DA80059UR-SC Ring stand 1 5/8 x 1 1/2 x 2 1/2"	\$8.00 BUY \$500+ \$6.00			
	DA80060UR-SC Ring stand 1 5/8 x 1 1/2 x 2 3/4"	\$8.10 BUY \$500+ \$6.08		DA8004RV-SC 4 ring vertical bar 1 3/4 x 4 x 1"	\$13.43 BUY \$500+ \$10.08
	DA28A01UR-SC Universal ring tray 2 3/8 x 2 1/4 x 1 1/2"	\$7.29 BUY \$500+ \$5.46		DA8005RH-SC 5 ring horizontal bar 7 1/4 x 1 5/8 x 1"	\$16.31 BUY \$500+ \$12.23
	DA8002RV-SC 2 ring vertical bar 1 3/4 x 2 1/8 x 1"	\$9.60 BUY \$500+ \$7.20		DA28C05UR-SC 5 universal ring tray 6 3/4 x 2 1/4 x 1 1/2"	\$14.39 BUY \$500+ \$10.79
	DA8002RH-SC 2 ring horizontal bar 3 1/4 x 1 5/8 x 1"	\$9.60 BUY \$500+ \$7.20		DA28D05UR-SC 5 universal ring tray 4 5/8 x 4 x 1 1/2"	\$19.19 BUY \$500+ \$14.39
	DA8003RV-SC 3 ring vertical bar 1 3/4 x 3 x 1"	\$11.19 BUY \$500+ \$8.40		DA28E05RD-SC 5 ring duo tray 6 3/4 x 4 x 1 1/2"	\$22.71 BUY \$500+ \$17.03
	DA8003RH-SC 3 ring horizontal bar 4 1/2 x 1 5/8 x 1"	\$12.01 BUY \$500+ \$9.01		DA28E07UR-SC 7 ring tray 6 3/4 x 4 x 1 1/2"	\$22.39 BUY \$500+ \$16.79

Save 25% when you buy \$500 or more!

Item	Part No. / Description	Price/ea.	Item	Part No. / Description	Price/ea.
	DA28D07UR-SC 7 universal ring tray 4 5/8 x 4 x 1 1/2"	\$22.47 BUY \$500+ \$15.35		DAF400T-SC Ring feature stand 2 5/8 x 2 1/4 x 4"	\$15.99 BUY \$500+ \$11.99
	DA28E08UR-SC 8 ring tray 6 3/4 x 4 x 1 1/2"	\$21.75 BUY \$500+ \$16.31		DAF400S-SC Ring feature stand 2 5/8 x 2 1/4 x 3"	\$16.67 BUY \$500+ \$11.75
	DA28D08UR-SC 8 universal ring tray 4 5/8 x 4 x 1 1/2"	\$20.29 BUY \$500+ \$15.22		DARF110-SC Ring finger 2 7/8 x 2 5/8 x 1 7/8"	\$6.25 BUY \$500+ \$4.69
	DA28E11UR-SC 11 ring tray 6 3/4 x 4 x 1 1/2"	\$21.75 BUY \$500+ \$16.31		DARD130-SC Ring disc 1 1/4" Diameter	\$6.48 BUY \$500+ \$4.92

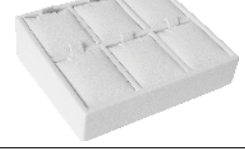
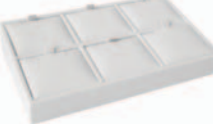
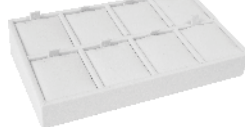
Item	Part No. / Description	Price/ea.	Item	Part No. / Description	Price/ea.
	DA350P-SC Pendant stand 2 3/8 x 1 1/2 x 3 1/2"	\$8.00 BUY \$500+ \$6.00		DA225P-SC Pendant stand 2 3/8 x 2 1/4 x 2"	\$6.40 BUY \$500+ \$4.80
	DA345P-SC Pendant stand 3 x 2 x 4"	\$14.93 BUY \$500+ \$11.19		DA234P-SC Pendant stand 2 1/2 x 2 x 3"	\$9.60 BUY \$500+ \$7.20
	DA28A01PD-SC Pendant tray 2 3/8 x 2 1/4 x 1 1/2"	\$8.32 BUY \$500+ \$6.24		DA28C03PD-SC 3 pendant tray 6 3/4 x 2 1/4 x 1 1/2"	\$19.19 BUY \$500+ \$14.39
	DA28D04PD-SC 4 pendant tray 4 5/8 x 4 x 1 1/2"	\$25.27 BUY \$500+ \$18.95		DA28D06PD-SC 6 pendant tray 4 5/8 x 4 x 1 1/2"	\$27.19 BUY \$500+ \$20.39
	DA28E06PD-SC 6 pendant tray 6 3/4 x 4 x 1 1/2"	\$27.19 BUY \$500+ \$20.39		DA28E08PD-SC 8 pendant tray 6 3/4 x 4 x 1 1/2"	\$30.39 BUY \$500+ \$22.79

Save 25% when you buy \$500 or more!

Item	Part No. / Description	Price/ea.	Item	Part No. / Description	Price/ea.
	DACES12-SC Earring stand 1 1/4 x 1 1/2 x 2 1/8"	\$7.95 BUY \$500+ \$5.96		DACES36-SC Earring stand 2 3/4 x 1 3/4 x 3 1/2"	\$9.00 BUY \$500+ \$6.75
	DACES13-SC Earring stand 1 1/4 x 1 7/8 x 2 3/4"	\$7.95 BUY \$500+ \$5.96		DASLD6-SC Earring sled 2 x 8 1/4 x 2"	\$9.60 BUY \$500+ \$7.20
	DA28A01FE-SC Flap earring tray 2 3/8 x 2 1/4 x 1 1/2"	\$9.60 BUY \$500+ \$7.20		DA28A01PE-SC Pierced earring tray 2 3/8 x 2 1/4 x 1 1/2"	\$8.24 BUY \$500+ \$6.18
	DA28C03FE-SC 3 flap earring tray 6 3/4 x 2 1/4 x 1 1/2"	\$15.99 BUY \$500+ \$11.99		DA28C03PE-SC 3 pierced tray 6 3/4 x 2 1/4 x 1 1/2"	\$17.27 BUY \$500+ \$12.95
	DA28D04FE-SC 4 flap earring tray 4 5/8 x 4 x 1 1/2"	\$25.27 BUY \$500+ \$18.95		DA28D04PE-SC 4 pierced earring tray 4 5/8 x 4 x 1 1/2"	\$22.21 BUY \$500+ \$16.66
	DA28D06FE-SC 6 flap earring tray 4 5/8 x 4 x 1 1/2"	\$28.79 BUY \$500+ \$21.59		DA28D06PE-SC 6 pierced earring tray 4 5/8 x 4 x 1 1/2"	\$31.18 BUY \$500+ \$23.86
	DA28E06FE-SC 6 flap earring tray 6 3/4 x 4 x 1 1/2"	\$28.79 BUY \$500+ \$21.59		DA28E06PE-SC 6 pierced earring tray 6 3/4 x 4 x 1 1/2"	\$27.19 BUY \$500+ \$20.39
	DA28E08FE-SC 8 flap earring tray 6 3/4 x 4 x 1 1/2"	\$34.69 BUY \$500+ \$26.01		DA28E08PE-SC 8 pierced earring tray 6 3/4 x 4 x 1 1/2"	\$27.19 BUY \$500+ \$20.39

Save 25% when you buy \$500 or more!

Item	Part No. / Description	Price/ea.	Item	Part No. / Description	Price/ea.
	DASBS12-SC Bangle "T" bar 7 1/4 x 2 3/4 x 4 1/2"	\$25.50 BUY \$500+ \$19.13		DABS185-SC Bracelet sled 1 1/4 x 9 1/4 x 1 3/4"	\$7.90 BUY \$500+ \$5.93
	DAJP350V-SC Bracelet pillow w/stand 3 1/4 x 3 1/4 x 3 1/4"	\$8.90 BUY \$500+ \$6.68		DABS485-SC Bracelet sled 4 x 9 5/8 x 1 7/8"	\$13.65 BUY \$500+ \$10.24
	DADB425-SC Bracelet dome 4 1/8 x 5 1/8 x 2 1/2"	\$26.90 BUY \$500+ \$20.18			
	DANF1026-SC Neck form 6 1/2 x 4 1/2 x 4"	\$22.00 BUY \$500+ \$16.50		DANF1029-SC Neck form 7 x 6 1/2 x 7 1/4"	\$37.42 BUY \$500+ \$28.07
	DANF1028-SC Neck form 6 1/2 x 4 1/2 x 6"	\$35.00 BUY \$500+ \$26.25		DANF2003-SC Neck form 3 x 2 1/2 x 3 1/2"	\$14.39 BUY \$500+ \$10.79
	DANF1027-SC Neck form 7 x 6 1/2 x 4 3/4"	\$49.00 BUY \$500+ \$36.75		DANF1034-SC Neck form 6 3/4 x 6 x 7 5/8"	\$39.80 BUY \$500+ \$28.85
	DACHR16-SC Chain ramp / Rem. pad 10 1/4 x 16" chain pad 10 3/4 x 16 1/2 x 3 1/2"	\$96.00 BUY \$500+ \$72.00		DA1081R-SC Pres. tray w/ring 10 1/2 x 8 5/8 x 1"	\$40.87 BUY \$500+ \$30.65
	DACW884-SC Chain display wedge 8 x 8 x 4"	\$41.26 BUY \$500+ \$30.95		DAPCF5510-SC Counter pad plain 10 1/4 x 5 3/8 x 3/4" closed 10 1/4 x 11 x 3/8" open	\$29.02 BUY \$500+ \$21.75
	DASB211 Sign stand 2 3/4 x 2 3/16 x 1 1/4"	\$8.53 BUY \$500+ \$6.40			

Save 25% when you buy \$500 or more!

Item	Part No. / Description	Price/ea.	Item	Part No. / Description	Price/ea.
	05000300-SC Loose Diamond Arch 11.5" x 4" x 1.5"	\$59.60 BUY \$500+ \$44.70		Minimum order: 5 pcs 05000301 Diamond Cup 1.125" diameter x .75"	\$9.60 BUY \$500+ \$7.20
	05000299-SC Pearl Half Moon 8" x 8" x 3.25"	\$76.60 BUY \$500+ \$57.45		05000298-SC Wave Chain Ramp 10.125" x 9" x 2.625"	\$71.08 BUY \$500+ \$53.31
	Sign size: 3.9375" x 2.375" 05000300 Acrylic Sign 1.1875" x 4" x 2.75"	\$12.90 BUY \$500+ \$9.68		05000302 Bevelled Edge Mirror 8.5" x 8.25" x 5.5"	\$44.00 BUY \$500+ \$33.00

The Locking Watch Display

05000244
The Locking Watch Display \$399.00
16" x 16"



Bolts into your floor board.



New

05000581-SC
Pendant/earring tray
with PVC signage
4.75" x 9.5" x 2"
BUY \$500+ \$37.00

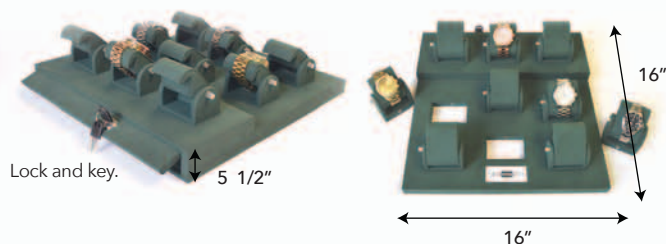

CREATE
Your Own Look Jewelry Displays

Window Displays

WHISPER



ESTATE



VANTAGE



CREATE CREATE CREATE

Your Own Look Jewelry Displays

NEW DISPLAY PRESENTATION FOR YOUR SHOWCASE.

Call our experts for assistance.

Vienna Leatherette - Group A



Charisma Suede - Group B



Novasuede - Group C



Stocked Fabrics & Color Choices

Fabric for Floorboards - Minimum order of 2 yards x 54" wide

Cut Yardage Pricing

Vienna	FIF1007936	\$52.00/yard
Charisma	FIF1037722	\$69.00/yard
Elite	FIF1037723	\$69.00/yard
Nova	FIF1037724	\$112.00/yard

Cutting Charge: \$70.00 for any order under 10 yards.



CREATE CREATE CREATE

Your Own Look Jewelry Displays

ELEMENT AND SHOWCASE PLATFORM STYLES

Call our experts for assistance.

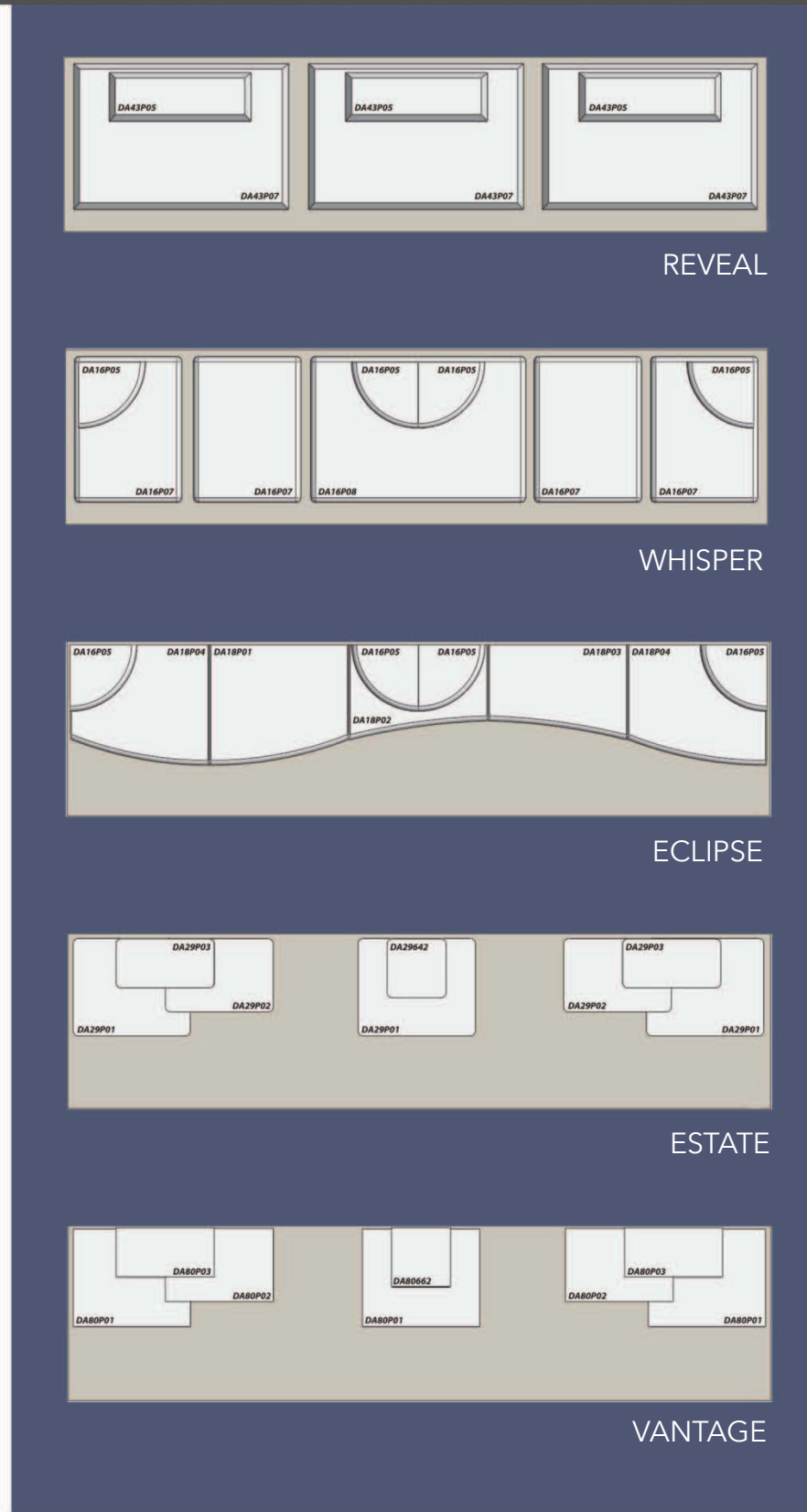
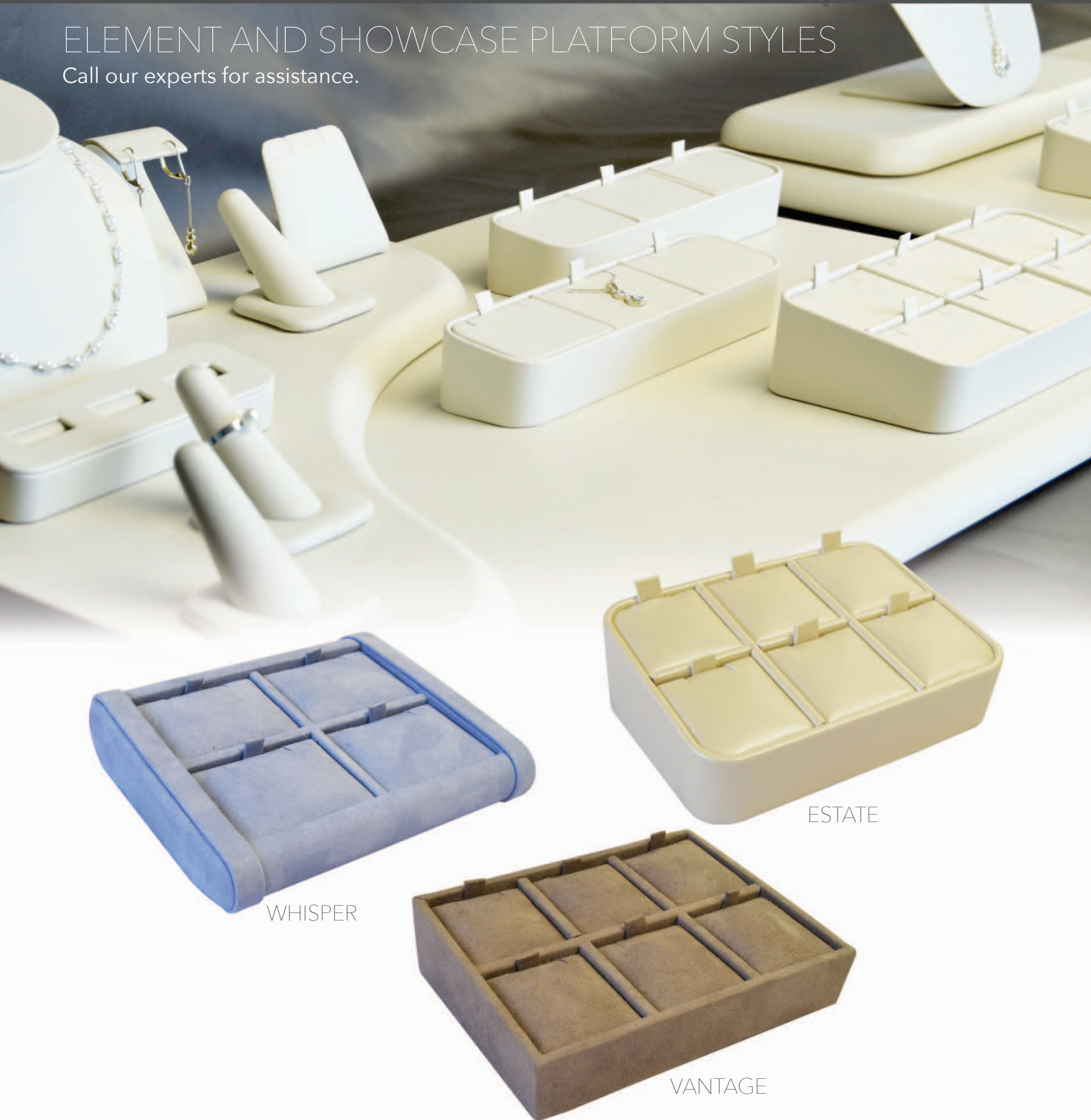

CREATE CREATE CREATE

Your Own Look Jewelry Displays

ENGAGEMENT RING DISPLAY with Hide-A-Tag Ring Towers and Ring Trays*



Suggested layout. Shown in Palladium Linea.

**HIDE-A-TAG
FEATURE***



Display By Setting Style:



Solitaire



Halo



Three Stone



Multi Stone

Choose your colour, fabric and unique signage.

Available in the 11" x 15", twenty two and twenty five ring display and 16" x 15", twenty five ring display.

*Hide-A-Tag not available in our Estate series.



**HIDE-A-TAG
FEATURE***

11" Engagement Ring Display Vignette - **Whisper**

WHI_088R1_()_WHI_KIT

- 11" Platform • 2 Small Ring Towers
- 4 Large Ring Towers • 2 Vertical Ring Trays
- 2 Five Ring Trays • 1 Laser sign

A) Vienna	\$300.00
(B) Charisma	\$345.00
(C) Novasuede	\$395.00



**HIDE-A-TAG
FEATURE***

11" Engagement Ring Display Vignette - **Vantage**

VAN_100R1_()_WHI_KIT

- 11" Platform • 2 Small Ring Towers
- 4 Large Ring Towers • 2 Vertical Ring Trays
- 2 Five Ring Trays • 1 Horizontal Ring Tray • 1 Laser sign

(A) Vienna	\$210.00
(B) Charisma	\$235.00
(C) Novasuede	\$270.00



11" Engagement Ring Display Vignette - **Estate**

EST_100R1_()_WHI_KIT

- 11" Platform • 2 Small Ring Towers
- 4 Large Ring Towers • 2 Vertical Ring Trays
- 2 Five Ring Trays • 1 Horizontal Ring Tray • 1 Laser sign

(A) Vienna	\$195.00
(B) Charisma	\$225.00
(C) Novasuede	\$255.00



**HIDE-A-TAG
FEATURE***

16" Engagement Ring Display Vignette - **Whisper**

WHI_100R1_()_WHI_KIT

- 16" Platform • 2 Small Ring Towers
- 4 Large Ring Towers • 1 Vertical Ring Tray
- 2 Five Ring Trays • 2 Horizontal Ring Trays • 1 Laser sign

(A) Vienna	\$320.00
(B) Charisma	\$340.00
(C) Novasuede	\$380.00

Minimum \$1200.00 per order.

Please allow 8 - 10 weeks for delivery.

Please allow 2 - 3 weeks for printed items from approved art.

IN STOCK

IN STOCK

Please allow 2 - 3 weeks for printed items from approved art.



Rope Handle Paper Totes

- Matte lamination
- Matching rope handle
- Minimum order is 100 in any size

CODE	TYPE	SIZE (inches)	PRICE/EACH		
			100 +	500 +	1000 +
A 239606 __	Novelty	6 x 3.5 x 6 x 3.5	\$0.72	\$0.64	\$0.61
B 239709 __	Small gift	9 x 3.5 x 7 x 3.5	\$0.85	\$0.75	\$0.70
C 239810 __	Gift	8 x 4 x 10 x 4	\$0.91	\$0.83	\$0.76
D 230908 __ T	Trapezoid	9/7 x 4 x 8.5 x 4	\$1.02	\$0.89	\$0.86
E 238116 __	Fashion	16 x 6 x 12 x 6	\$1.61	\$1.41	\$1.35
F 23940408	Wine (silver only)	4.75 x 4 x 14 x 4	\$1.10	\$1.02	\$0.86
G 231011 __	Watch	10 x 5 x 11 x 5	\$1.03	\$0.87	\$0.83
H 23881098	Diamond Tote	8 x 4 x 10 x 4	\$1.07	\$0.95	-

PREMIUM HIGH STYLE EUROTOTES AVAILABLE IN 8 COLORS

15 Black	00 White	07 Gold	08 Silver	42 Brown	11 Blue	66 Burgundy	10 Green
Novelty							
Small Gift							
Gift							
Trapezoid							
Fashion							
Watch							
Wine							

Durable & Fashionable!

FOIL PRINT
 <1000 - 20¢ each
 >1000 - 18¢ each

Eclipse and Geo Eurototes

Eurototes that match our Eclipse and Geo hinged packaging.

- Matching rope handles
- Minimum 100 per color
- Can be Foil Printed on one side only

CODE	SIZE (inches)	PRICE/EACH	
		100+	500+
A 230606 ___	6 x 3.5 x 6 x 3.5	\$0.91	\$0.84
B 231008 ___	10.5 x 5 x 8.5 x 5	\$1.14	\$1.03



FOIL PRINT
 <1000 - 20¢ each
 >1000 - 18¢ each



Winter Forest

Laminated Paper Shoppers with Rope Handle

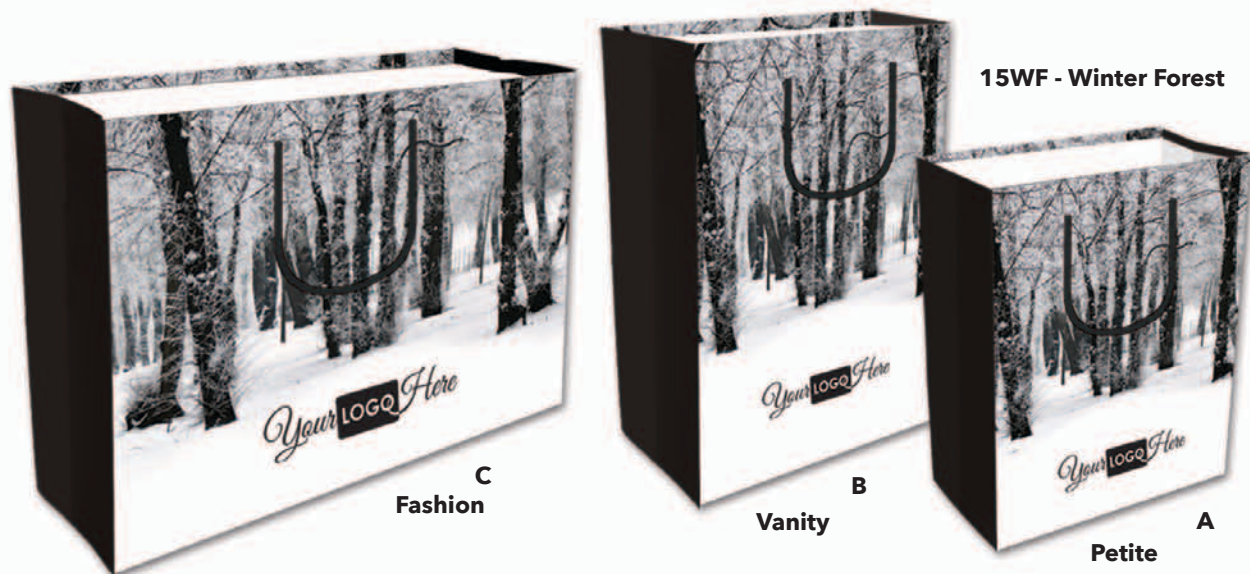

Christmas Village

Laminated Paper Shoppers with Rope Handle



FOIL PRINT
<1000 - 20¢ each
>1000 - 18¢ each



FOIL PRINT
<1000 - 20¢ each
>1000 - 18¢ each

CODE	TYPE	SIZE (inches)	CASE	PRICE/EACH	
				100+	500+
A 230809	Petite	8 x 4 x 10 x 4	100	\$0.80	\$0.65
B 231013	Vanity	10 x 5 x 13 x 5	100	\$0.88	\$0.74
C 231612	Fashion	16 x 6 x 12 x 6	100	\$1.21	\$1.01



London Shoppers

Paper Shoppers with Grosgrain Handle

- Matte and Gloss laminated colors, plus uncoated kraft
- Five sizes and nine colors
- Minimum order is 100 per size per color

CODE	SIZE (inches)	CASE	PRICE/EACH	
			100 +	1000 +
A 235863	6 x 3 x 6 x 3	100	\$0.86	\$0.78
B 235879	8 x 4 x 10 x 4	100	\$1.11	\$1.01
C 235886	12.5 x 4.5 x 9 x 4.5	100	\$1.51	\$1.35
D 235887	16 x 6 x 12 x 6	100	\$1.90	\$1.69
E 235888	20 x 6 x 14 x 6	50	\$2.70	\$2.45



FOIL PRINT
<1000 - 20¢ each
>1000 - 18¢ each

	15M Black Matte	15G Black Gloss	00M White Matte	00G White Gloss	02G Champagne Gloss	08G Pewter Gloss	75M Kraft Matte	03M Mustard Matte	01G Pink Gloss
6 x 3 x 6 x 3	U	U	U	U	U	U	U	U	U
8 x 4 x 10 x 4	U	U	U	U	U	U	U	U	U
12.5 x 4.5 x 9 x 4.5	U	U	U	U	U	U	U	U	U
16 x 6 x 12 x 6	U	U	U	U	U	U	U	U	U
20 x 6 x 14 x 6	U	U	U	U	—	—	U	—	—

Please allow 2 - 5 weeks for printed items from approved art.

SPECIAL ORDER

SPECIAL ORDER

Please allow 3 - 5 weeks for printed items from approved art.



Manhattan Tote Bags

Uncoated Paper, Twill Ribbon Handle

- Made with recycled material
- Minimum order is 100 per size per color
- Foil Printing is available

CODE	TYPE	SIZE (inches)	CASE	PRICE /EACH	
				100 +	1000 +
A 245845 __	Mini	5 x 4 x 6 x 4	100	\$0.83	\$0.78
B 245841 __	Small	8 x 4 x 10 x 4	100	\$1.11	\$0.93
C 245843 __	Medium	10 x 5 x 13 x 5	100	\$1.39	\$1.28
D 245844 __	Large	16 x 6 x 12 x 6	100	\$1.83	\$1.54
E 245860 __	X-Large	20 x 6 x 14 x 6	50	\$2.74	\$2.32
F 245898 __	Bottle Bag	4.5 x 4.5 x 15 x 4.5	100	\$1.18	\$0.90



FOIL PRINT
 <1000 - 20¢ each
 >1000 - 18¢ each

	15 Black	00 White	75 Kraft	08 Grey	81 Ivory	12 Espresso	09 Red	41 Fuchsia	11 Navy	10 Green	60 - Light Green	
Mini	U	U	U	U	U	U	U	U	U	U	U	
Small	U	U	U	U	U	U	U	U	U	U	U	
Medium	U	U	U	U	U	U	U	U	U	U	U	
Large	U	U	U	U	U	U	U	U	U	U	U	
X-Large	U	U	U	—	—	—	—	—	—	—	—	
Bottle	U	U	U	—	—	U	—	—	—	—	—	

Mod Tote Bags

Matte Laminated, Fold-over Tops

- Contains 30% recycled material
 - Die-cut handle
- Minimum order is 100 per size
- Foil Printing is available

CODE	TYPE	SIZE (inches)	CASE	PRICE/EACH	
				100 +	1000 +
A 245800 __	Micro Mini With Rectangular Handle	5.75 x 1.75 x 5.75 x 1.75	100	\$1.25	\$1.04
B 245846 __	Mini With Rectangular Handle	8 x 2.5 x 8 x 2.5	100	\$1.46	\$1.23
C 245847 __	Medium With Round Handle	12 x 4 x 12 x 4	100	\$2.26	\$1.89
D 245848 __	Mega With Triangle Handle	15 x 5.5 x 15 x 5.5	100	\$3.13	\$2.98
E 245855 __	Bottle Bag With Circular Handle	4.5 x 3.375 x 15.5 x 3.375	100	\$1.44	\$1.29
F 245859 __	Two Bottle Bag With Rectangular Handle	8.25 x 3.375 x 15.2 x 3.375	100	\$1.90	\$1.69



FOIL PRINT
 <1000 - 20¢ each
 >1000 - 18¢ each

	15 Black	00 White	08 Silver	41 Fuchsia	10 Green	11 Blue	97 Trellis
Micro	U	U	U	U	U	U	U
Mini	U	U	U	U	U	U	U
Medium	U	U	U	U	U	U	U
Mega	—	—	—	—	—	—	—
Bottle	U	—	—	—	—	—	U
Two Bottle	U	—	—	—	—	—	—

All print orders subject to \$30 set-up charge. Applicable artwork, and plate charges may apply. See page 126.

All print orders subject to \$30 set-up charge. Applicable artwork, and plate charges may apply. See page 126.



The Ultimate Environmental Choice ...

Featuring Woven Paper Rope Handles



Custom Rope Handle Paper Eurototes

Make a creative impression... the combinations are endless!

Prices include up to 2 ink print colors:

SIZE (inches)	TYPE	PRICE/EACH		
		3,000	5,000	10,000
6 x 3.5 x 6 x 3.5	Novelty	\$0.540	\$0.458	\$0.413
9 x 3.5 x 7 x 3.5	Small Gift	\$0.680	\$0.579	\$0.521
8 x 4 x 10 x 4	Petite	\$0.732	\$0.623	\$0.560
9/7 x 4 x 8.5 x 4	Trapezoid	\$0.899	\$0.764	\$0.688
3.375 x 3.5 x 13 x 3.5	Wine	\$0.680	\$0.583	\$0.525
16 x 6 x 12 x 6	Fashion	\$1.414	\$1.204	\$1.085
16 x 6 x 19 x 6	Saville	\$1.709	\$1.538	\$1.477

Prices include 4 color process print:

6 x 3.5 x 6 x 3.5	Novelty	\$0.590	\$0.450	\$0.434
9 x 3.5 x 7 x 3.5	Small Gift	\$0.745	\$0.608	\$0.547
8 x 4 x 10 x 4	Petite	\$0.760	\$0.654	\$0.588
9/7 x 4 x 8.5 x 4	Trapezoid	\$0.944	\$0.803	\$0.722
3.375 x 3.5 x 13 x 3.5	Wine	\$0.714	\$0.612	\$0.551
16 x 6 x 12 x 6	Fashion	\$1.484	\$1.264	\$1.139
16 x 6 x 19 x 6	Saville	\$1.794	\$1.615	\$1.551

• Combination foil print and ink printing available

Great for resale or promotions!

- No charge for printing plates (\$275 proof charge applies)
- Substitute a satin ribbon handle for the standard rope - add \$0.10/ea.
- Add metal grommets to your bag for only \$0.06/ea.



FOIL PRINT
Add \$0.06/ea. per side
< 25% coverage

100% Recyclable All Paper Shoppers

Consider adding our industry-first ALL PAPER ROPE HANDLES to your custom eurotote! Up to 40% post-consumer content. Water based inks and varnishes.

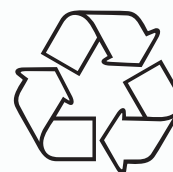

SIZE (inches)	TYPE	3,000	5,000	10,000
6 x 3.5 x 6 x 3.5	Novelty	\$0.700	\$0.630	\$0.570
9 x 3.5 x 7 x 3.5	Small Gift	\$0.780	\$0.710	\$0.640
8 x 4 x 10 x 4	Gift	\$0.830	\$0.750	\$0.670
10 x 5 x 13 x 5	Vanity	\$0.870	\$0.780	\$0.700
16 x 6 x 12 x 6	Fashion	\$1.310	\$1.180	\$1.060

Design your own bag online with our interactive **MyDesign™** tool!
www.gunthermele.com



We can customize to any size bag you require - just ask!

Please allow 2 - 3 weeks for printed items from approved art.

IN STOCK

IN STOCK

Please allow 2 - 3 weeks for printed items from approved art.

New

The Ultimate in recyclability.

The 100% Recyclable ALL PAPER Shopper

Industry first, with durable PAPER ROPE HANDLES. 40% post-consumer content.



CODE	SIZE (inches)	CASE	PRICE/EACH	
			100+	1000+
A 230606	6 x 3.5 x 6 x 3.5	100	\$0.66	\$0.59
B 231013	10 x 5 x 13 x 5	100	\$0.82	\$0.73
C 231612	16 x 6 x 12 x 6	100	\$1.24	\$1.11



75AK - Kraft 00AW - White 15AB - Black

New



DEBOSSING
<1000 - 20¢ each
>1000 - 18¢ each



FOIL PRINT
<1000 - 20¢ each
>1000 - 18¢ each

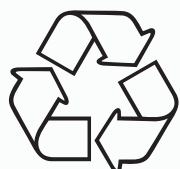

Paper Twist Handle Shopping Bags

Sturdy, durable paper shoppers. Our best value bags.

* Minimum order quantity is one case pack

CODE	TYPE	SIZE (inches)	CASE	12 - Kraft PRICE/EACH			00 - White PRICE/EACH		
				200 +	250+	1000 +	200 +	250+	1000 +
230508	Prime	5 x 3.5 x 8 x 3.5	250	-	\$0.30	\$0.26	-	\$0.37	\$0.30
230809	Petite	8 x 4 x 10 x 4	250	-	\$0.32	\$0.28	-	\$0.38	\$0.34
230914	Vanity	10 x 5 x 13 x 5	250	-	\$0.37	\$0.35	-	\$0.45	\$0.43
231315	Celebrity	13 x 6 x 15.5 x 6	250	-	\$0.41	\$0.39	-	\$0.48	\$0.46
231611	Fashion	16 x 6 x 12 x 6	250	-	\$0.43	\$0.40	-	\$0.49	\$0.47
231619	Saville	16 x 6 x 19 x 6	200	\$0.54	-	\$0.49	\$0.61	-	\$0.56
231819	Universal	18 x 6 x 19 x 6	200	\$0.62	-	\$0.59	\$0.78	-	\$0.74
230513	Wine Shopper	5.25 x 3.5 x 13	250	-	\$0.43	\$0.40	-	\$0.43	\$0.41



Celebrity Universal Petite Fashion Saville



FOIL PRINT
<1000 - 20¢ each
>1000 - 18¢ each



INK PRINT
<1000 - 18¢ each
>1000 - 16¢ each



DIGITAL PRINT
99¢ each
minimum 300 bags

All print orders subject to \$30 set-up charge. Applicable artwork, and plate charges may apply. See page 126.



Tri-fold Handle Paper Bags

CODE	SIZE (inches)	CASE	PRICE/EACH	
			250+	1000+
A 23080912T	8.25 x 4.75 x 11.5	250	\$0.32	\$0.29
B 23091412T	10 x 5 x 13.25	250	\$0.36	\$0.35
C 23161112T	16 x 6 x 12.5	250	\$0.43	\$0.39

Kraft Merchandise Die Cut Bags

Reinforced foldover handle plus side gusset.

CODE	SIZE (inches)	CASE	PRICE/EACH
23081275	8 x 2 x 12	500	\$0.246
23101575	10 x 2 x 15	500	\$0.280
23141875	14 x 4 x 18	250	\$0.392

Kraft and White Paper Merchandise Bags

CODE	SIZE (in)	CASE	75 - Kraft	00 - White
			PRICE/EACH	PRICE/1000
230507	6 x 9	2000	\$0.025	\$0.039
230710	7 x 10	500	\$0.039	\$0.062
230912	9 x 12	500	\$0.062	\$0.084
231114	11 x 14	500	\$0.084	\$0.118
231316	13 x 16	500	\$0.095	\$0.151



DIGITAL PRINT
99¢ each
minimum 300 bags



INK PRINT
<1000 - 18¢ each
>1000 - 16¢ each



FOIL PRINT
<1000 - 20¢ each
>1000 - 18¢ each

SIZES

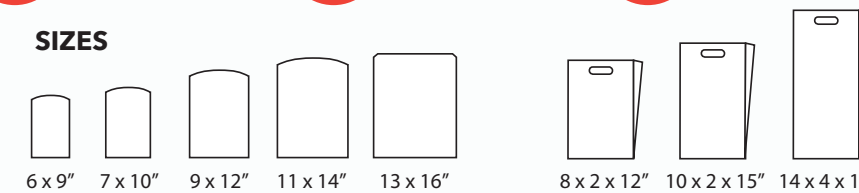

Full Color Digital Printing

*Prints on all reusable and paper bags we sell!

- low minimums (300 bags)
- no plate charges

Add to any bag* for just 0.99¢ each (min. 300 bags)



All print orders subject to \$30 set-up charge. Applicable artwork, and plate charges may apply. See page 126.

Please allow 2 - 3 weeks for printed items from approved art.

SPECIAL ORDER

Pinstripe on Kraft



Tints on Kraft



Enlarged to show pinstripe.



Tints and Pinstripe on Kraft

CODE	TYPE	SIZE (Inches)	CASE	PRICE/EACH		
				200+	250+	1000+
230508 __(_)	Prime	5.25 x 3.5 x 8.25 x 3.5	250	–	\$0.45	\$0.39
230809 __(_)	Petite	8.25 x 4.25 x 10.75 x 4.25	250	–	\$0.46	\$0.40
231611 __(_)	Fashion	16 x 6 x 12.5 x 6	250	–	\$0.55	\$0.50
231619 __(_)	Saville	16 x 6 x 19 x 6	200	\$0.70	–	\$0.62



FOIL PRINT
<1000 - 20¢ each
>1000 - 18¢ each



INK PRINT
<1000 - 18¢ each
>1000 - 16¢ each



Floating Flake

CODE	TYPE	SIZE (inches)	CASE	PRICE/EACH		
				200+	250+	500+
23081012SK	Petite	8 x 4 x 10 x 4	250	–	\$0.54	\$0.49
23131512SK	Celebrity	13 x 6 x 15.5 x 6	250	–	\$0.59	\$0.53
23161912SK	Saville	16 x 6 x 19 x 6	200	\$0.71	–	\$0.64



FOIL PRINT
<1000 - 20¢ each
>1000 - 18¢ each



INK PRINT
<1000 - 18¢ each
>1000 - 16¢ each



FOIL PRINT
<1000 - 20¢ each
>1000 - 18¢ each



INK PRINT
<1000 - 18¢ each
>1000 - 16¢ each

Damask Paper Shoppers

CODE	TYPE	SIZE (inches)	CASE	PRICE/EACH	
				100+	1000+
23080915D	Petite	8 x 4 x 10 x 4	100	\$0.52	\$0.44
23101315D	Vanity	10 x 5 x 13 x 5	100	\$0.56	\$0.48
23161215D	Fashion	16 x 6 x 12 x 6	100	\$0.66	\$0.57

SPECIAL ORDER

Please allow 2 - 3 weeks for printed items from approved art.

Gingham Print



Pinstripe on Kraft



Gloss Claycoat on White

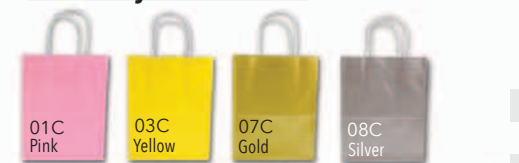

FOIL PRINT
<1000 - 20¢ each
>1000 - 18¢ each

All bag sizes available in these colors.



09 - Red 41 - Fuchsia 15 - Black 11 - Aqua 08 - Slate Grey



00 - White 19 - Lime 75 - Kraft 01 - Solid White



FOIL PRINT
<1000 - 20¢ each
>1000 - 18¢ each



Tints, Pinstripe on Kraft, Gingham Print, and Gloss Claycoat on White

CODE	TYPE	SIZE (Inches)	CASE	PRICE/EACH		
				200+	250+	1000+
230508 __(_)	Prime	5.25 x 3.5 x 8.25 x 3.5	250	–	\$0.62	\$0.52
230809 __(_)	Petite	8.25 x 4.25 x 10.75 x 4.25	250	–	\$0.54	\$0.46
231611 __(_)	Fashion	16 x 6 x 12.5 x 6	250	–	\$0.67	\$0.57
231619 __(_)	Saville	16 x 6 x 19 x 6	200	\$0.82	–	\$0.70

San Francisco Shoppers

Uncoated Gloss Paper, Twist Handle

- 100% recyclable, biodegradable
- Minimum order is 100 per size



Matching 2-Piece Berkeley Nest Boxes in 4 Sizes
See page 32 for more information.

CODE	TYPE	SIZE (inches)	CASE	PRICE/EACH	
				100 +	1000 +
A 245803 __	Small	7 x 3 x 7 x 3	100	\$0.65	\$0.58
B 245804 __	Medium	10 x 4 x 10 x 4	100	\$0.87	\$0.78
C 245811 __	Large	16 x 6 x 12 x 6	100	\$1.16	\$1.01

All print orders subject to \$30 set-up charge. Applicable artwork, and plate charges may apply. See page 126.



Best prices in the country for printed paper shoppers!

1) PICK A BAG SIZE

Sizes shown are (standard):
Width x Side Gusset x Height



NO PLATE CHARGES!

• All custom orders subject to +/- 20% over/under run

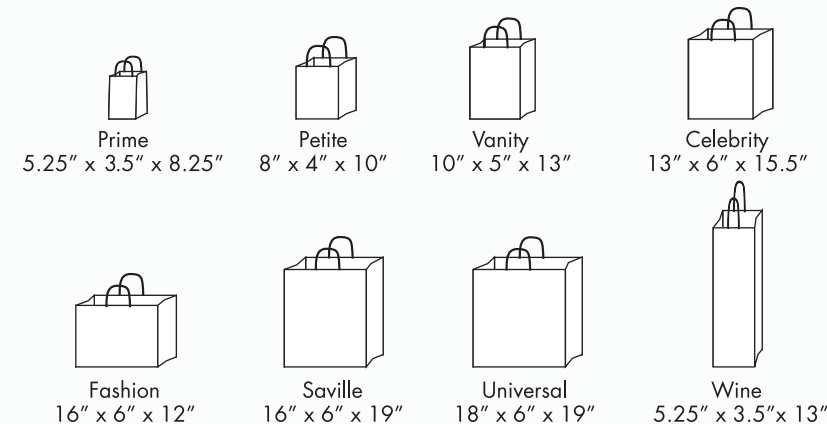

2) PICK A PRINT COLOR

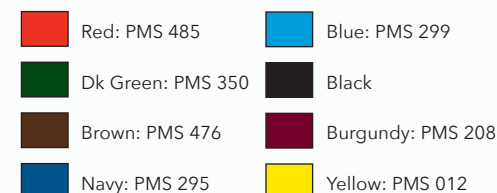

Metallic Colors

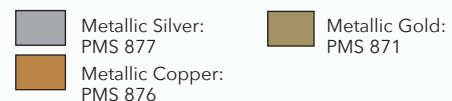

Don't see the color you want?
Send us a pantone # and we'll match at no extra charge!

**5,000 Petite Kraft Shoppers
\$1475.00 printed!**

**5,000 Petite White Shoppers
\$1750.00 printed!**

Simply Paper Shoppers

Kraft with paper twist handles, print 1 color on 2 sides <25%

STOCK NUMBER	TYPE	SIZE (inches)	CASE PACK	PRICE/EACH		Any 2 Sizes Min. 3000 per size
				5,000	10,000	
23050812GC	Prime	5.25 x 3.5 x 8.25	250	\$0.275	\$0.255	\$0.320
23080912GC	Petite	8 x 4 x 10	250	\$0.295	\$0.275	\$0.345
23091412GC	Vanity	10 x 5 x 13	250	\$0.330	\$0.310	\$0.390
23131512GC	Celebrity	13 x 6 x 15.5	250	\$0.390	\$0.365	\$0.480
23161112GC	Fashion	16 x 6 x 12	250	\$0.360	\$0.340	\$0.400
23161912GC	Saville	16 x 6 x 19	200	\$0.445	\$0.410	\$0.495
23181912GC	Universal	18 x 6 x 19	200	\$0.455	\$0.420	\$0.525
23051312GC	Wine	5.25 x 3.5 x 13	250	\$0.295	\$0.275	\$0.375

White with paper twist handles, print 1 color on 2 sides <25%

STOCK NUMBER	TYPE	SIZE (inches)	CASE PACK	PRICE/EACH		Any 2 Sizes Min. 3000 per size
				5,000	10,000	
23050800GC	Prime	5.25 x 3.5 x 8.25	250	\$0.320	\$0.300	\$0.360
23080900GC	Petite	8 x 4 x 10	250	\$0.350	\$0.330	\$0.390
23091400GC	Vanity	10 x 5 x 13	250	\$0.420	\$0.390	\$0.480
23131500GC	Celebrity	13 x 6 x 15.5	250	\$0.500	\$0.460	\$0.560
23161100GC	Fashion	16 x 6 x 12	250	\$0.450	\$0.420	\$0.510
23161900GC	Saville	16 x 6 x 19	200	\$0.590	\$0.550	\$0.670
23181900GC	Universal	18 x 6 x 19	200	\$0.600	\$0.560	\$0.680
23051300GC	Wine	5.25 x 3.5 x 13	250	\$0.380	\$0.350	\$0.470

- Minimum 5,000 per size or any 2 sizes, minimum 3000 per size
- Add a second color for just \$0.04/ea
- For 100% ink coverage, add \$0.029/ea
- Add a rope handle for just \$0.08/ea



INK PRINT

One color included in the price of the bag



FOIL PRINT

Add \$0.06/ea. per side

Design your own bag online with our interactive **MyDesign™** tool!
www.gunthermele.com



Simply Bags
We can customize to any size bag you require - just ask!

All print orders subject to \$30 set-up charge. Applicable artwork, and plate charges may apply. See page 126.

Please allow 2 - 3 weeks for printed items from approved art.

IN STOCK

IN STOCK

Please allow 2 - 3 weeks for printed items from approved art.



Foil Printed Merchandise Bags

- Constructed of 1.75 mil low density poly
- Minimum order is 1,000 per size printed, minimum one case pack, unprinted.
- Foil Printing is available on one side only and is included in the price of the printed bags
- Die charge extra
- For no-print option please add N to code number.

CODE	TYPE	SIZE (inches)	CASE PACK	PRICE/EACH		
				1000 Foil Print	3000 Foil Print	1000 No Print
* A 220609 __	Notion	6 x 9	1000	\$0.19	\$0.14	\$0.10
* B 220811 __	Die Cut	8.25 x 11	1000	\$0.23	\$0.17	\$0.14
* C 221114 __	Die Cut	11 x 14	1000	\$0.25	\$0.20	\$0.15
D 221418 __	Die Cut	14.5 x 18	1000	\$0.34	\$0.28	\$0.19
E 221721 __	Patch	16.5 x 20 + 4	500	\$0.40	\$0.35	\$0.22
F 222024 __	Patch	20 x 24 + 4	500	\$0.56	\$0.52	\$0.26

* Gold available in 3 sizes only



FOIL PRINT
 <1000 - 20€ each
 >1000 - 18€ each

Celestial Pattern High Density Poly

- Minimum order one case pack

No printing available.

CODE	TYPE	SIZE (inches)	CASE	PRICE/EACH
A 55091241C	Merchandise	9 x 12	1000	\$0.10
B 55141841C	Merchandise	14 x 18 + 3	1000	\$0.20
C 55081041C	Petite Shopper	8 x 4 x 10 x 4	250	\$0.43
D 55161241C	Fashion Shopper	16 x 6 x 12 x 6	250	\$0.60
E 55161941C	Saville Shopper	16 x 6 x 19 x 6	250	\$0.71

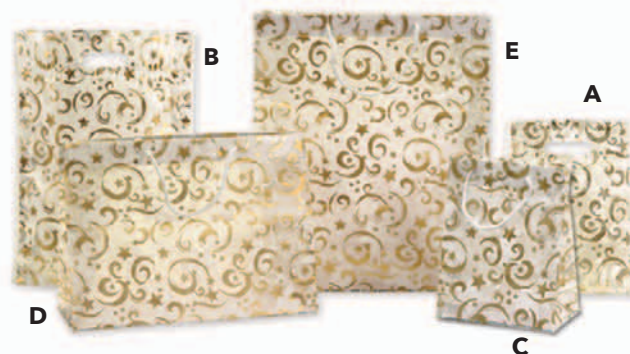

Shoppers



Merchandise bags

Frosted Clear Bags

• Minimum order one case pack

CODE	TYPE	GAUGE	SIZE (in)	CASE	PRICE/EACH
A 55091200E	Merchandise	2.0	9 x 12	1000	\$0.09
B 55141800E	Merchandise	2.0	14 x 18 + 3	1000	\$0.18
C 55081000E	Petite Shopper	3.0	8 x 4 x 10 x 4	250	\$0.36
D 55161200E	Fashion Shopper	3.0	16 x 6 x 12 x 6	250	\$0.50
E 55181600E	Majestic Shopper	3.0	18 x 6 x 16 x 6	250	\$0.57

FOIL PRINT
 <1000 - 20€ each
 >1000 - 18€ each

Frosted Brights Translucent Bags

• Minimum order one case pack



FOUR fresh frosty colors to choose from!

CODE	TYPE	GAUGE	SIZE (in)	CASE	PRICE/EACH
A 550912 __	Merchandise	2.0	9 x 12	1000	\$0.08
B 551418 __	Merchandise	2.0	14 x 18 + 3	1000	\$0.17
C 550810 __	Petite Shopper	3.0	8 x 4 x 10 x 4	250	\$0.33
D 551612 __	Fashion Shopper	3.0	16 x 6 x 12 x 6	250	\$0.46
E 551816 __	Majestic Shopper	3.0	18 x 6 x 16 x 6	250	\$0.51

FOIL PRINT
 <1000 - 20€ each
 >1000 - 18€ each



Poly-Merchandise Bags

Easy to Order - Follow our four easy steps on the next page!

Large or small, we've got a bag for you!

Choose a loop handle for drawstring for just \$40/1000



CODE	SIZE (in)	White or Clear Poly: PRICE/EACH			Colored Poly: PRICE/EACH			STANDARD PRINT SIZE
		3,000	5,000	10,000	3,000	5,000	10,000	
550912	9 x 12	N/A	\$0.098	\$0.91	N/A	\$0.099	\$0.094	6" wide
551114	11 x 14	N/A	\$0.115	\$0.108	N/A	\$0.123	\$0.114	7" wide
551216	12 x 16 + 3	N/A	\$0.140	\$0.126	N/A	\$0.147	\$0.138	8" wide
551416	14 x 16 + 3	\$0.229	\$0.196	\$0.177	\$0.244	\$0.209	\$0.189	10" wide
551720	17 x 20 + 4	\$0.313	\$0.249	\$0.225	\$0.334	\$0.263	\$0.236	12" wide
551816	18 x 16 + 4	\$0.283	\$0.227	\$0.204	\$0.298	\$0.238	\$0.214	13" wide
552020	20 x 20 + 4	\$0.345	\$0.276	\$0.249	\$0.362	\$0.290	\$0.261	14" wide
552024	20 x 24 + 4	\$0.401	\$0.321	\$0.289	\$0.411	\$0.328	\$0.295	14" wide

- Constructed of 1.5 mil gauge poly
- Minimum quantity 5,000 (small sizes)/ 3,000 (large sizes)
- Print two sides in 1 ink color (maximum 25% ink coverage)

No Plate Charges* *Does not include process plates.

5000 Printed Bags for only \$495.00

white 9" x 12" printed 1 color, 2 sides with fold over die cut handles



INK PRINT

One color included in the price of the bag

1) PICK A BAG MATERIAL

Low Density LDPE

The most common poly material used in bags. This material has a softer feel than High Density and offers greater tensile strength, clarity and flexibility.

High Density HDPE

Is twice as strong as Low Density poly and feels stiff in comparison with little stretchability. This unique material allows bags to be produced with either a translucent (frosty) appearance or a solid opaque look.



Consider adding our oxo-biodegradable option.

Add 10% to price.

2) PICK YOUR BAG SIZES & HANDLE STYLE

Sizes shown are Width x Height + Bottom Gusset

STANDARD SIZES

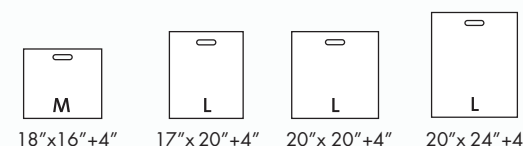
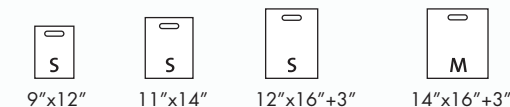

HANDLE STYLES



die cut
fold over die cut
reinforced patch add \$0.08/ea
loop handles add \$0.04/ea
draw string add \$0.04/ea

3) PICK A BAG COLOR**

- White
- Grey: PMS CG2
- Charcoal: PMS CG9
- Red: PMS 485
- Brown: PMS 1545
- Burgundy: PMS 506
- Navy: PMS 296
- Green: PMS 350
- Dusty Rose: PMS 507
- Kraft: PMS 466
- Sage Green: PMS 624
- Mint: PMS 351
- Black
- Yellow: PMS Yellow
- Ivory: PMS 1205
- Purple: PMS 267
- Peach: PMS 149
- Orange: PMS 021
- Pink: PMS 176
- Lilac: PMS 256
- Blue: PMS 300
- Teal: PMS 327

Don't see the color you want? Send us a pantone number and we'll match at no extra charge!

4) PICK AN INK COLOR

- Red: PMS 485
- Dk Green: PMS 350
- Brown: PMS 476
- Navy: PMS 295
- Blue: PMS 299
- Black
- Burgundy: PMS 208
- Yellow: PMS 012

Metallic Colors (add \$0.01 each)

- Metallic Gold: PMS 871
- Metallic Silver: PMS 877
- Metallic Copper: PMS 876

Get Creative!

Add more print colors for just \$0.04 each

- All custom orders subject to +/- 20% over/under run
- **Add 15% for metallic gold or silver bag colors.

Design your own bag online with our interactive **MyDesign™** tool!
www.gunthermele.com



We can customize to any size bag you require - just ask!

All print orders subject to \$30 set-up charge. Applicable artwork, and plate charges may apply. See page 126.



Printed Poly Shopping Bags

Customize simply and affordably.

CODE	TYPE	White or Clear Poly: PRICE/EACH			Colored Poly: PRICE/EACH			STANDARD PRINT SIZE
		3,000	5,000	10,000	3,000	5,000	10,000	
550907	Small Gift	\$0.355	\$0.301	\$0.287	\$0.373	\$0.317	\$0.309	5" wide
550414	Wine	\$0.504	\$0.394	\$0.374	\$0.569	\$0.435	\$0.404	2.5" wide
550810	Petite	\$0.369	\$0.313	\$0.250	\$0.386	\$0.329	\$0.312	5" wide
551612	Fashion	\$0.632	\$0.539	\$0.511	\$0.666	\$0.612	\$0.533	9" wide
551816	Majestic	\$0.775	\$0.660	\$0.626	\$0.814	\$0.693	\$0.657	10" wide

Simply Make It Yours!

No Plate Charges*

*Does not include process plates.

- Print two sides in 1 ink color (maximum 25% ink coverage)
- Constructed of 3.0 mil high density poly
- Coordinating poly loop handles included in price
- Poly Shoppers minimum quantity 3,000 per size

3000 Printed Shopping Bags for only \$1107.00

white, petite: 8" x 4" x 10" x 4" printed 1 color, 2 sides with loop handles



INK PRINT

One color included in the price of the bag

1) PICK A BAG SIZE

Sizes shown are (standard):
Width x Side Gusset x Height
x Bottom Gusset

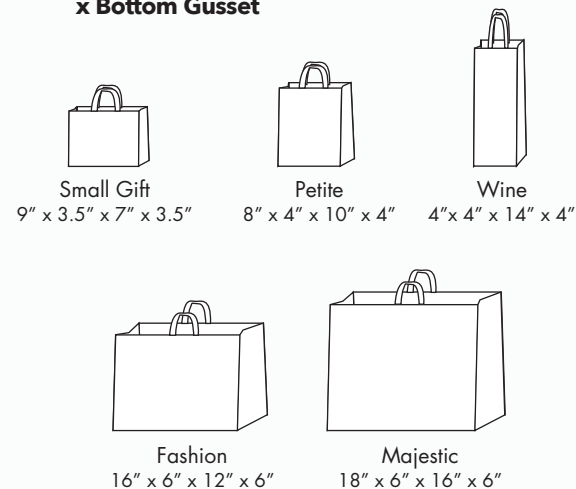

2) PICK A HANDLE STYLE

Loop
(included)



Die Cut
(no charge)



Rope, Cotton or Poly
(add \$0.081/ea)



Tube
(add \$0.090/ea)



Consider adding our oxo-biodegradable option.
Add 10% to price.

3) PICK A BAG COLOR



Don't see the color you want? Send us a pantone number and we'll match at no extra charge!

4) PICK AN INK COLOR

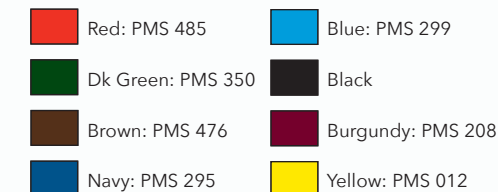

Metallic Colors (add \$0.01 each)

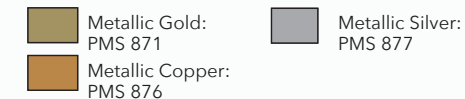

Get Creative!

Add more print colors for just \$0.04 each

- All custom orders subject to +/- 20% over/under run
- **Add 15% for metallic gold or silver bag colors.

Design your own bag online with our interactive **MyDesign™** tool!
www.gunthermele.com



We can customize to any size bag you require - just ask!

Please allow 2 - 3 weeks for printed items from approved art.

IN STOCK

SPECIAL ORDER

Please allow 3 - 5 weeks for printed items from approved art.



CODE	DESCRIPTION	SIZE (inches)	PACK	PRICE/EACH	
				100+	1000+
A 21141600S	Four Seasons Tote	14 x 4 x 16 x 4	100	\$1.59	\$1.29
B 21141615WF	Winter Forest Tote	14 x 6 x 16 x 6	100	\$1.59	\$1.29
C 21141616B	Bamboo Fabric Tote	14 x 4 x 16 x 4	100	\$2.19	\$1.79
D 21111315BW	Six Bottle Wine Tote	11.5 x 7.25 x 13 x 7.25	100	\$1.79	\$1.35
E 21141629	Two-tone Non-woven Tote	14 x 6 x 16 x 6	100	\$1.39	\$1.25
F 21081075C	Small Kraft Composite Tote	8 x 4 x 10 x 4	100	\$1.29	\$0.99
G 21141675C	Large Kraft Composite Tote	14 x 6 x 16 x 6	100	\$1.59	\$1.29
H 21141615B	Black Tote with 4" gussett	14 x 4 x 16 x 4	100	\$1.39	\$0.99
I 21141655B	Black Tote with 8" gussett	14 x 8 x 16 x 8	100	\$1.49	\$1.09
J 21141609R	Red Tote with 8" gussett	14 x 8 x 16 x 8	100	\$1.49	\$1.09
K 60161612	Foldable Bag with zipper	16 x 16 x 4	24	\$1.99	\$1.89
L 22161601	Pink Polyester Foldable Bag	16 x 16	100	\$1.49	\$0.99

-  **FOIL PRINT**
<1000 - 20¢ each
>1000 - 18¢ each
-  **SCREEN PRINT**
<500 is 60¢/bag,
>500+ is 50¢/bag,
>1000+ is 40¢/bag.
Silk screen set-upcharge \$65.00
-  **DIGITAL PRINT**
99¢ each
minimum 300 bags
-  **PAD PRINT**
<500 is 22¢ each
>500 is 20¢ each



Toronto Totes

<1000 - 20¢ each
>1000 - 18¢ each

CODE	DESCRIPTION	SIZE (inches)	PACK	PRICE/EACH	
				100+	1000+
A 215909 __	Small Tote	9 x 5 x 12 x 5	100	\$1.14	\$1.04
B 215916 __	Large Tote	16 x 6 x 14 x 6	100	\$1.56	\$1.35

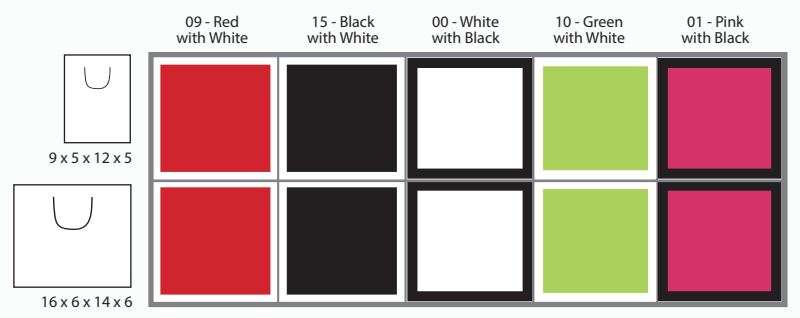

 **FOIL PRINT**
<1000 - 20¢ each
>1000 - 18¢ each

CODE	DESCRIPTION	SIZE (inches)	PACK	PRICE/EACH	
				100+	1000+
215805 __	Large Metallic Tote	15.5 x 6 x 14.25 x 6	100	\$2.50	\$1.85

Metallic Reusable Totes



1) PICK A MATERIAL:

Non-woven Polypropylene

Soft, yet durable. Use this for light to medium weight loads.

Woven Polypropylene

Our strongest material. This rigid weave will handle heavy items.

Recycled P.E.T. (100% post consumer)

Recycled water and soda bottles are the main source of P.E.T. plastic used to weave this material. Strong, soft and enviro-friendly.

2) PICK A BAG SIZE



9 x 4 x 12 x 4"



11.5 x 7 x 13 x 7"



14 x 4 x 16 x 4"



16 x 5 x 16 x 5"

3) CREATE A GRAPHIC IMAGE

Submit your own design or let our graphics team create a unique look for you!

Full Color Laminated Reusable Bags

Convey your message vividly. See next page for options!



NEW! LOWER MINIMUM ORDER QUANTITY - 2,000 bags	NON-WOVEN POLYPROPYLENE PRICE/EACH		WOVEN POLYPROPYLENE PRICE/EACH	
	2,000	5,000	2,000	5,000
Shopping Bags (inches)				
9 x 4 x 12 x 4	\$1.80	\$1.09	\$1.80	\$1.09
11.5 x 7 x 13 x 7	\$1.89	\$1.20	\$1.89	\$1.20
14 x 4 x 16 x 4	\$2.05	\$1.25	\$2.05	\$1.25
16 x 5 x 16 x 5	\$2.15	\$1.39	\$2.15	\$1.39

- Plates extra: \$695.00 per design
 Additions:
 • Zipper top for \$0.25/bag
 • Gusset print: \$0.10/bag
 • Add matte lamination for just \$0.04/bag
 • Add a carded bottom for \$0.05/bag

Many more sizes available - just ask!



For greater strength - Add a coordinating nylon webbing handle at no extra charge.



We can customize to any size bag you require - just ask!

ADDITIONAL FOIL PRINT 14¢ each Lead time 12-14 weeks



- | | | | | | |
|---|------------------------|---|--------------------------|---|----------------------------|
| A | BG126 - Black Emboss | D | YB016 - Silver/Snakeskin | G | YB002 - Steel Grey |
| B | YB018 - Gold/Snakeskin | E | AY002 - Matte Red | H | BY002 - Met. Copper/Orange |
| C | BG017 - Pink Squares | F | AL001 - Holographic | I | AG034 - Black PU |



Add some sparkle, style, shimmer and shine with these NEW fashionable totes!

- Price includes hotstamp on one side
- Available in two sizes
- Minimum 5000 per size

Embossed Laminated Reusable Bags

SIZE (inches)	Price/each
8 x 4 x 10 x 4	\$1.20
14 x 4 x 16 x 4	\$1.72



Fabric Style Shoppers



1) PICK A BAG SIZE

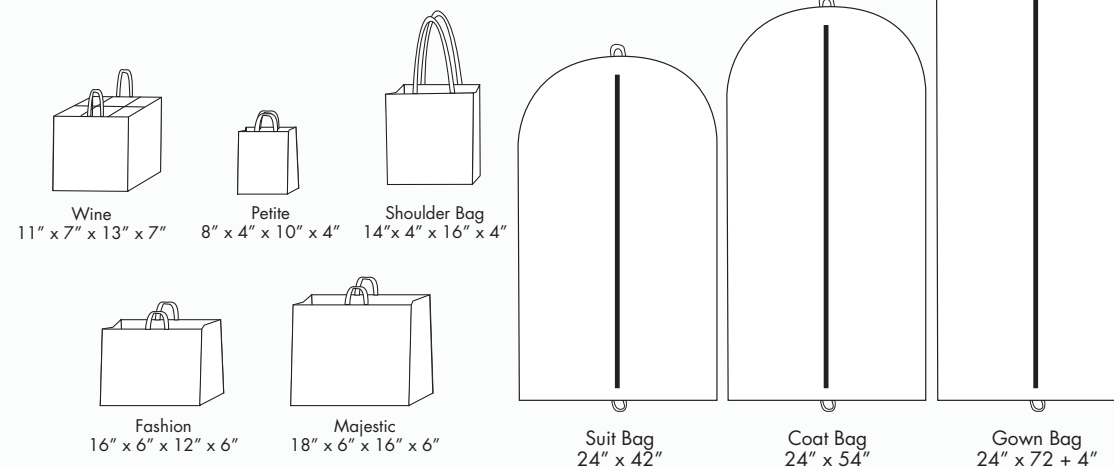

Reusable Fabric Style Shoppers

SIZE (inches)	TYPE	PRICE/EACH	
		1,000	3,000
11 x 7 x 13 x 7	Wine (6 bottle)	\$1.89	\$1.38
8 x 4 x 10 x 4	Petite	\$1.59	\$1.25
14 x 4 x 16 x 4	Shoulder Bag	\$1.79	\$1.35
16 x 6 x 12 x 6	Fashion	\$1.69	\$1.29
18 x 6 x 16 x 6	Majestic	\$1.99	\$1.49
24 x 42	Suit Bag	\$2.62	\$1.99
24 x 54	Coat Bag	\$2.74	\$2.32
24 x 72 + 4	Gown Bag	\$3.90	\$4.48

NO PLATE CHARGES!

Pricing includes printing on one side with one color.

- 75gm non-woven
- Minimum custom print order is 1,000 bags
- Choose from these 8 popular sizes
- Price includes screen print, 1 color, one side



This bottle carrier has a divided section.



SILK SCREEN
One color included in the price of the bag

2) PICK A BAG COLOR



3) PICK A PRINT COLOR

- Blue: PMS 299
- Navy: PMS 295
- Dk. Green: PMS 350
- Lime: PMS 584
- Brown: PMS 476
- Black
- Yellow: PMS 012
- Orange: PMS 021
- Red: PMS 485
- Burgundy: PMS 208
- Pink: PMS 204
- Metallic Silver: PMS 877
- Metallic Copper: PMS 876
- Metallic Gold: PMS 871

Don't see the print color you want? Send us a pantone # and we'll match at no extra charge!

For in stock reusable totes, see page 98.

Get the custom look starting at just 1,000 minimum.

Simply Bags
We can customize to any size bag you require - just ask!

Please allow 2 - 3 weeks for printed items from approved art.

IN STOCK

SPECIAL ORDER

Please allow 3 - 5 weeks for printed items from approved art.



White Folding Gift Boxes

- Our most economical option.
- Ships flat and stores flat.

CODE	DESCRIPTION	SIZE (inches)	CASE	PRICE/EACH	
				100 +	1000 +
32058003	G58 Baby Mugs	3.5 x 3.5 x 2	100	\$0.23	\$0.21
32001003	G1 Mugs	4 x 4 x 4	100	\$0.24	\$0.22
32002003	G2 Cups and Saucers	6 x 6 x 4	100	\$0.34	\$0.29
32043003	G43 Bowls, etc.	10 x 8 x 4	100	\$0.48	\$0.45
32033003	G33 Bowls, etc.	10 x 10 x 6	50	\$1.12	\$1.00
32005003	G5 Teapots, etc.	8 x 8 x 5	100	\$0.69	\$0.62
32006003	G6 Teapots, etc.	8 x 8 x 8	50	\$1.01	\$0.91
32048003	G48 Fork, Knife, Spoon	13 x 4 x 2	100	\$1.19	\$1.07
32036003	G36 Casseroles	11 x 11 x 4.5	50	\$0.92	\$0.83
32013003	G13 Plates	5 x 5 x 2	100	\$0.33	\$0.28
32004003	G4 Plates	8 x 8 x 2	100	\$0.58	\$0.49
32008003	G8 Plates	11 x 11 x 2	100	\$0.69	\$0.62
32009003	G9 Plates	13.5 x 13.5 x 2	50	\$0.95	\$0.87
32040003	G40 Plates	15 x 15 x 2	50	\$1.32	\$1.20
32049003	G49 Placemats, Trays, etc.	14 x 10 x 4	100	\$1.17	\$1.06
32003003	G3 All purpose	7 x 4 x 3	100	\$0.40	\$0.37
32010003	G10 All purpose	9 x 4.5 x 4.5	100	\$0.44	\$0.39
32038003	G38 All purpose	12 x 4 x 4	100	\$0.57	\$0.52
32041003	G41 All purpose	10 x 7 x 7	100	\$0.83	\$0.78
32051003	G51 All purpose	13 x 6 x 6	50	\$1.20	\$1.08
32039003	G39 Lazy Susans, Large Gifts	15 x 15 x 6	50	\$1.50	\$1.39
32024003	G24 Two Piece Boxes	6 x 6 x 10	100	\$1.46	\$1.32



FOIL PRINT
 <1000 - 20¢ each
 >1000 - 18¢ each



INK PRINT
 <1000 - 18¢ each
 >1000 - 16¢ each
 minimum charge \$28.80

All print orders subject to \$30 set-up charge. Applicable artwork, and plate charges may apply. See page 126.

Tuckit® Folding Gift Boxes

- Our glued boxes fold and tuck together for a solid bottom.
- 15 sizes available



CODE	SIZE (inches)	PACK	ECONO WHITE PRICE/EACH		KRAFT & COLORS PRICE/EACH		GLOSS COLORS PRICE/EACH	
			100+	1000+	100+	1000+	100+	1000+
# 334103	3 x 3 x 2	100	\$0.24	\$0.22	\$0.24	\$0.22	N/A	N/A
* 334180	3 x 3 x 3	100	\$0.25	\$0.23	\$0.27	\$0.24	N/A	N/A
334111	4 x 4 x 4	100	\$0.27	\$0.24	\$0.28	\$0.25	\$0.36	\$0.33
334115	6 x 4.5 x 4.5	100	\$0.31	\$0.28	\$0.39	\$0.36	\$0.46	\$0.42
334113	6 x 6 x 4	100	\$0.38	\$0.34	\$0.42	\$0.38	\$0.63	\$0.57
334114	6 x 6 x 6	100	\$0.43	\$0.39	\$0.49	\$0.44	\$0.64	\$0.58
334120	8 x 8 x 3.5	100	\$0.64	\$0.58	\$0.68	\$0.62	\$0.96	\$0.87
334121	8 x 8 x 6	50	\$1.05	\$0.95	N/A	N/A	N/A	N/A
334119	9 x 4.5 x 4.5	100	\$0.52	\$0.47	\$0.54	\$0.49	\$0.66	\$0.60
* 334183	10 x 5 x 4	100	\$0.56	\$0.51	\$0.59	\$0.53	N/A	N/A
334124	10 x 10 x 6	50	\$1.19	\$1.08	\$1.34	\$1.22	\$2.16	\$1.97
334131	12 x 6 x 6	50	\$1.21	\$1.10	\$1.32	\$1.20	\$1.74	\$1.58
334125	12 x 12 x 2.5	50	\$0.82	\$0.75	\$0.96	\$0.87	\$1.51	\$1.37
* 334136	12 x 12 x 5.5	50	\$1.53	\$1.39	\$1.60	\$1.46	\$2.47	\$2.24
• 334186	14 x 6 x 6	50	\$0.97	\$0.85	\$1.53	\$1.39	N/A	N/A

- * not available in purple
- # only available in kraft pinstripe and econo white
- only available in white gloss and kraft pinstripe
- 100% recycled content (min. 35% post consumer) - kraft excluded



FOIL PRINT
 <1000 - 20¢ each
 >1000 - 18¢ each



Bottom tucks into place for a secure fit.



Pop-Up Color Folding Gift Boxes

- Our most convenient folding gift box.
- Simple automatic bottom closure.

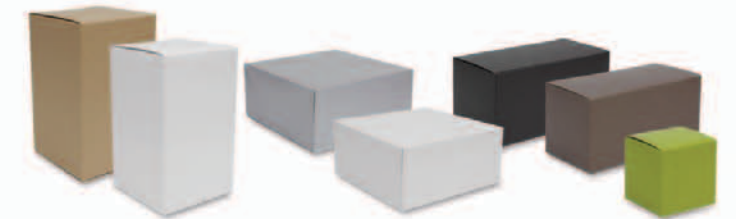

CODE	SIZE (inches)	CASE	PRICE/EACH		153 BLACK	123 BROWN	753 KRAFT	603 GREEN	083 SILVER	003 WHITE
			100 +	1000+						
34058	3 x 3 x 3	100	\$0.24	\$0.23						
34001	4 x 4 x 4	100	\$0.26	\$0.24						
34013	5 x 5 x 3.5	100	\$0.38	\$0.36						
34064	6 x 4.5 x 4.5	100	\$0.37	\$0.35						
34002	6 x 6 x 4	100	\$0.40	\$0.38						
34066	6 x 6 x 6	100	\$0.43	\$0.41						
34003	7 x 4 x 3	100	\$0.45	\$0.42						
34077	7 x 7 x 7	100	\$0.62	\$0.59						
34004	8 x 8 x 2	100	\$0.69	\$0.65						
34088	8 x 8 x 3.5	100	\$0.64	\$0.61						
34005	8 x 8 x 5.5	50	\$0.75	\$0.71						
34006	8 x 8 x 8.5	50	\$0.99	\$0.94						
34010	9 x 4.5 x 4.5	100	\$0.46	\$0.44						
34041	9.75 x 6.75 x 6.75	50	\$0.79	\$0.75						
34008	10.5 x 10.5 x 2 -2PC.	50	\$0.82	\$0.78						
34033	10 x 10 x 6	50	\$1.21	\$1.15						
34026	12 x 6 x 6	50	\$1.22	\$1.16						
34009	12 x 12 x 2.5 -2PC.	50	\$0.92	\$0.88						
34038	12 x 4 x 4	50	\$0.65	\$0.62						
34034	12 x 12 x 5.5 -2PC.	50	\$1.59	\$1.51						
34051	14 x 6 x 6	50	\$1.25	\$1.18						
34039	14 x 14 x 5 -2PC.	25	\$1.66	\$1.58						
34084	8 x 8 x 14 -2PC.	50	\$2.02	\$1.92						

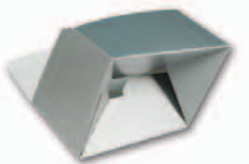

Bottom interlocks for easier assembly.



FOIL PRINT
 <1000 - 20¢ each
 >1000 - 18¢ each

All print orders subject to \$30 set-up charge. Applicable artwork, and plate charges may apply. See page 126.

Deliver the 'in-store' experience to your customer's door.



02B - Light Blue

93C - Charcoal



Four color process print available. Please inquire.

In Stock E-Commerce Gift Boxes

A variety of gift item sizes for your customer's unboxing experience.

- Reversible kraft boxes with grey or light blue interior
- Minimum case pack 25

CODE	DESCRIPTION	SIZE (inches)	PRICE/EACH	
			25+	250+
450606 ___	Small	6 x 6 x 4	\$1.29	\$1.04
451010 ___	Medium	10 x 10 x 6	\$2.89	\$2.31
451015 ___	Large	15 x 10 x 4	\$2.41	\$1.93
451712 ___	X-Large	17 x 12 x 5	\$3.50	\$2.80
451815 ___	XX-Large	18 x 15 x 6	\$4.46	\$3.57

FOIL PRINT
 <500 - 20¢ each
 >500 - 18¢ each
 minimum charge \$28.80

Complete the parcel with our instock tissue. See page 108.

Add a printed label from our in stock selection. See page 122 - 123.



Add a full color label from our digital print label selection. See page 124 - 125.

Custom E-Commerce Gift Boxes

Go above and beyond to impress customers and exceed their expectations by delivering more than just a product, but also an experience.

SIZE (inches)	Flexo Print - 1 Color PRICE/EACH		
	500	1,000	2500
10 x 6 x 4	\$5.20	\$3.25	\$2.22
11.125 x 8.75 x 4	\$5.69	\$3.65	\$2.60
14.5 x 7.25 x 5	\$5.88	\$3.97	\$2.95
17 x 12 x 4.25	\$6.22	\$4.51	\$3.58
17.125 x 11.125 x 2	\$6.14	\$4.22	\$3.17

Complete the parcel with custom tissue. See page 109.

NO PLATE CHARGES!

Pricing includes printing on one side.

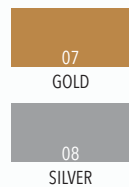
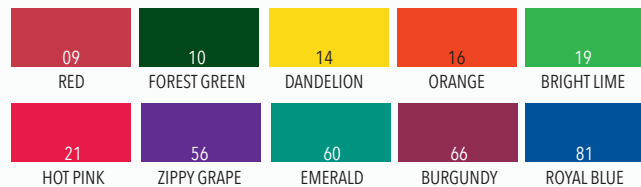

Spotlight Tissue Colors (UNPRINTED)

\$29.99* EVERYDAY

*Except Metallic Colors

CODE	DESCRIPTION	SIZE (in)	Packaged	PRICE/REAM		
				1 - 4 REAMS	5+ REAMS	25+ REAMS
20850100	White Economy	17 x 27	480	\$12.55	\$11.50	\$10.45
208551__G	Spotlight on Value (colors)	20 x 30	480	\$24.99	\$24.99	\$24.99
208559__G	Spotlight on Value (metallic)	20 x 30	200	\$35.95	\$32.95	\$29.95
20850101	#1 White Economy	17 x 13.5	480	\$7.30	\$6.25	\$5.50
20850400	#1 White Bleached	20 x 30	480	\$19.22	\$18.26	\$17.87
20851800	#1 White Bleached	18 x 9 dia.	1 roll	\$73.45/roll		
20852000	#1 White Bleached	20 x 9 dia.	1 roll	\$78.70/roll		



13 in stock tissue colors to choose from. Plus check out our assorted Pre-Packs!



20855901C



20855902C



20855903C



20855904C

Holiday Printed Tissue

Per design: 250 sheets - 20" x 30"

\$19.99/ream

Tissue Pre-Packs

CODE	DESCRIPTION	SIZE (in)	PRICE/PACK
20855100G	Spring Assortment	20 x 30	\$36.95
20855101G	Christmas	20 x 30	\$36.95

Christmas Pre-Pack

Contains 100 of each:
Red, Emerald, Metallic Gold, Metallic Silver.



Spring Assortment

Contains 100 of each:
Green, Lemon, Tangerine, Pink, Blue.

Pick a PMS print color and we will match it.

For metallic ink print: add 10% to the price above.

For > 50% ink coverage, an additional \$10 per ream.

All custom orders subject to a +/-10% over/under run.

Applicable artwork, set-up and plate charges apply.



INK PRINT

Included in price of tissue

Unprinted, minimum 1 ream (per color).
Must be ordered in increments of 1 reams.
Ships in approximately 4 - 6 weeks.

SPECIAL ORDER Tissue Colors (PRINTED AND UNPRINTED)

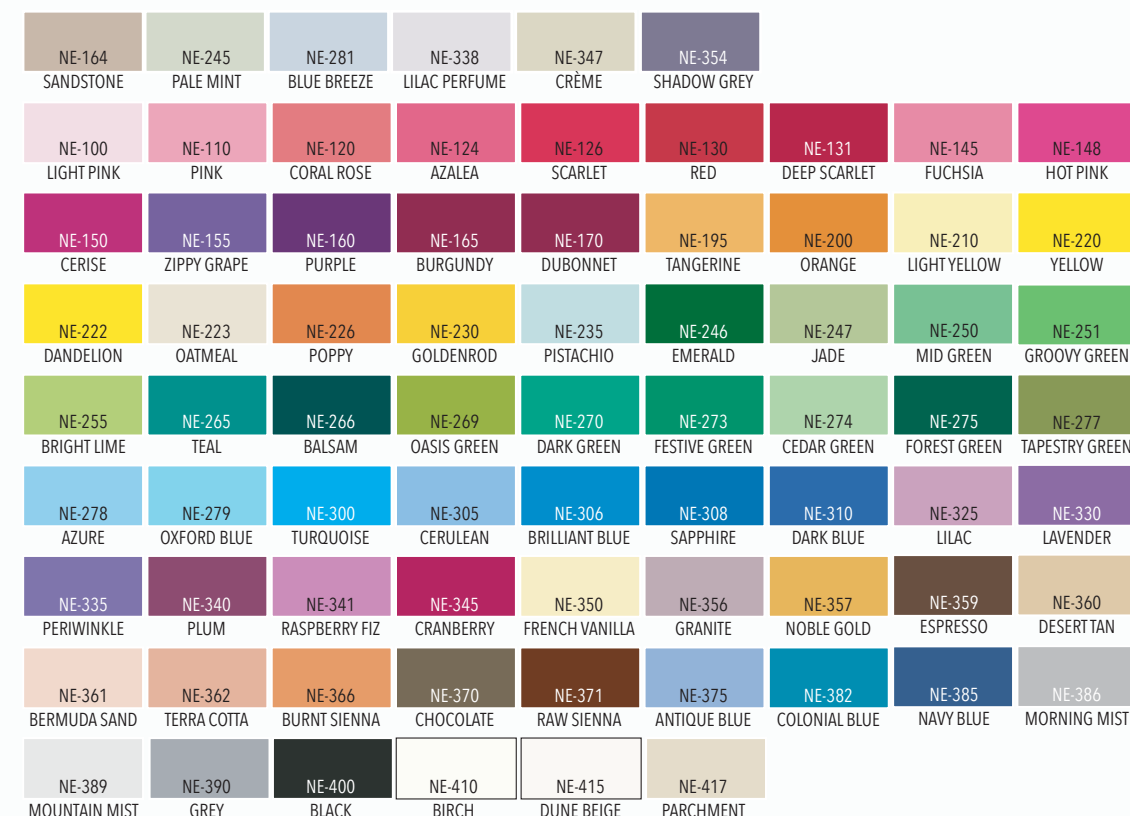

Special Order Tissue - Unprinted

CODE	DESCRIPTION	SIZE (in)	Packaged	PRICE/REAM	
				1 REAM	25+ REAMS
20899__	Special Order Colors	20 x 30	480	\$29.99	\$26.99

CREATE YOUR OWN LOOK

CUSTOM TISSUE

Please allow 6 - 8 weeks for printed items from approved art.



Custom Printed White Tissue - 10 Reams \$640.00

CODE	DESCRIPTION	SIZE (in)	Packaged	PRICE/REAM	
				10 REAMS	30 REAMS
20869000G	White	20 X 30	480	\$64.00	\$60.00
20869000M	Colored	20 x 30	480	\$89.00	\$81.00
20869000GK	Kraft	20 x 30	480	\$64.00	\$60.00

Minimum 10 reams. Note: Plates extra \$275.00 (per color).

One color on white (plate extra).





57657624 57657724 57657024 57657224 57657424 57657124
 57657324 57656424 57651324 57653524 57656724 57656924
 57654624 57655324 57655424 57656124 56300607 57300624 56900407



57605324 57605224 57604324 57604424 57604624 57604724
 57604824 57604924 57605024 57601724 57602224 57602924

Inspirations Gift Wrap

Code # 57 ___ 24 • Paper size: 24" x 417'

\$79.00 per 1/2 REAM ROLL

Inspirations Jewellers Rolls

Code # • Paper size: 8" x 150'

\$32.50/ROLL



Inspirations Giftwrap

By Gunther Mele



57602524 57602524S 57603224
 56300107 57300124 56300707 57300724



GW4138JRX150 GW0296JRX150 GW2534JRX150 GW1559JRX150
 GW0296JRX150 GW0396JRX150 GW1912JRX150 GW8024JRX150
 GW0738JRX150 GW1933JRX150

Sullivan Design Works Giftwrap Jewellers Rolls

Size: 7.375" x 150'

\$59.00 per roll



Giftwrap dispenser with serrated edge can be added to your custom jewellers roll order for \$7.00 each. Code: 09715000



Jewellers Rolls: minimum order 1 roll.

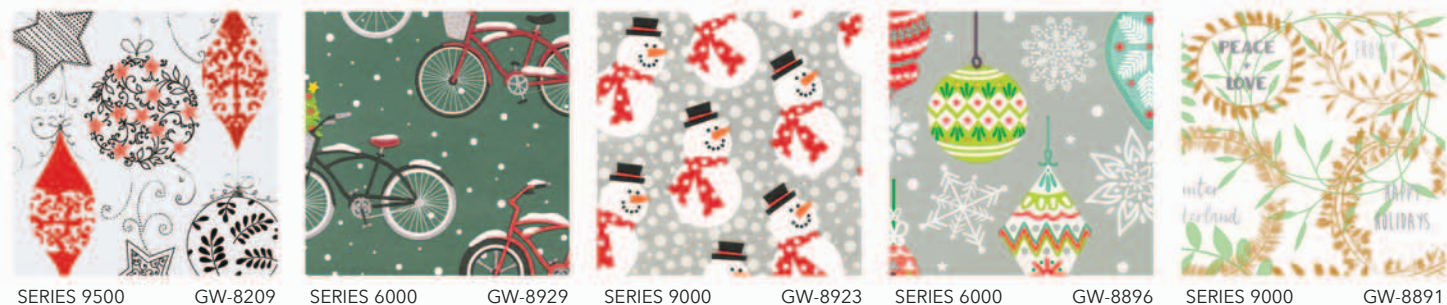

SERIES 9500 GW-8209 SERIES 6000 GW-8929 SERIES 9000 GW-8923 SERIES 6000 GW-8896 SERIES 9000 GW-8891



SERIES 9500 GW-8757 SERIES 6000 GW-8688 SERIES 9000 GW-8702 SERIES 9500 GW-8678 SERIES 9500 GW-8629



SERIES 2000 GW-8616 SERIES 9000 GW-8606 SERIES 9000 GW-8591 SERIES 9000 GW-8571 SERIES 9500 GW-8568

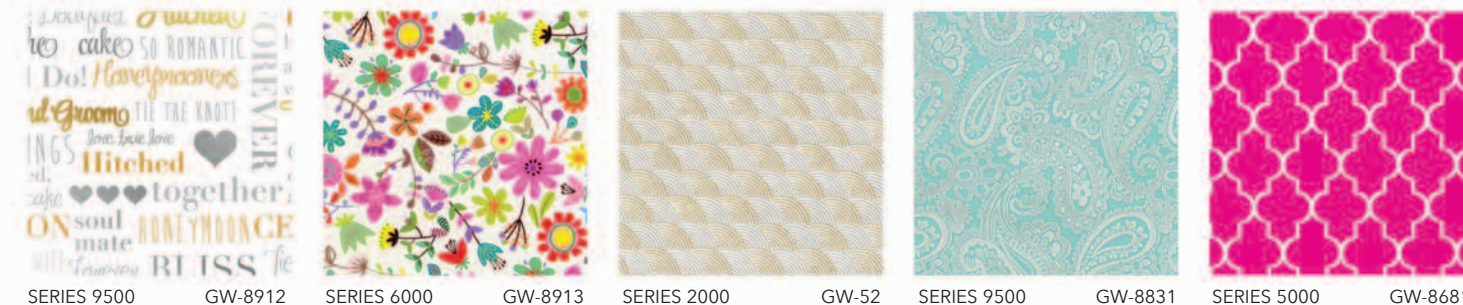

SERIES 9500 GW-8912 SERIES 6000 GW-8913 SERIES 2000 GW-52 SERIES 9500 GW-8831 SERIES 5000 GW-8681

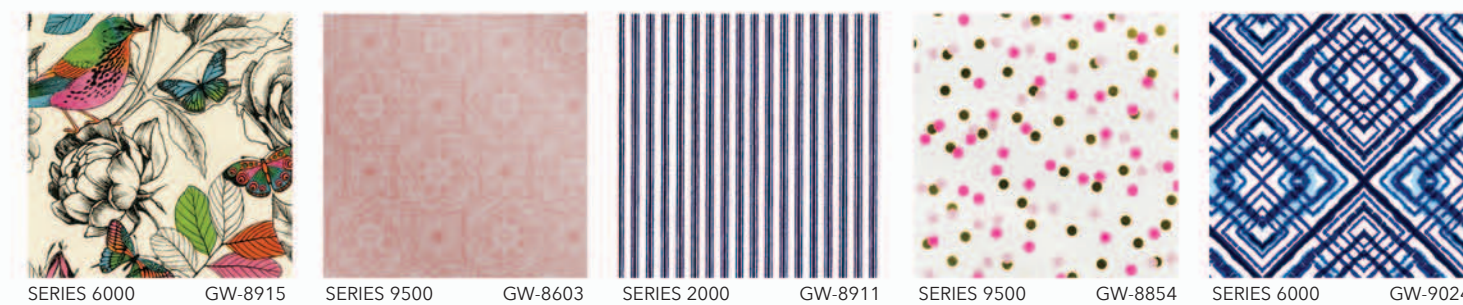

SERIES 6000 GW-8915 SERIES 9500 GW-8603 SERIES 2000 GW-8911 SERIES 9500 GW-8854 SERIES 6000 GW-9024

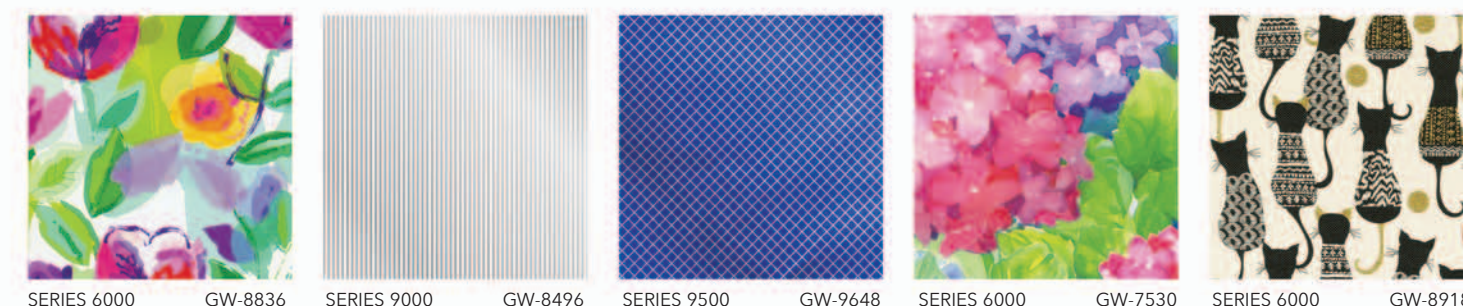

SERIES 6000 GW-8836 SERIES 9000 GW-8496 SERIES 9500 GW-9648 SERIES 6000 GW-7530 SERIES 6000 GW-8918

Sullivan Design Works **Seasonal** Gift Wrap

SULLIVAN designs available in 1/2 Ream Rolls and Full Ream Rolls

NOTE: All Sullivan giftwrap orders must include GW design code.

MINIMUM ORDER: 1 Roll of 417' (15" rolls must be ordered in multiples of 2 rolls per design)

SLITTING CHARGE: A slitting charge of \$25.00 applies to each individual roll. (no more than two slits per roll; (2 slits = \$25.00)

View our entire Selection online at GUNTHERMELE.COM

Additional custom order designs available to choose from. Contact your area sales representative for more info.

Sullivan Design Works **Every Day** Gift Wrap

Pricing Level	15H	18H	24H	30H	15F	18F	24F	30F
	Half Ream 15" x 417'	Half Ream 18" x 417'	Half Ream 24" x 417'	Half Ream 30" x 417'	Ream 15" x 833'	Ream 18" x 417'	Ream 24" x 833'	Ream 30" x 833'
1000 Series	\$78.57	\$108.61	\$108.61	\$125.94	\$122.47	\$186.02	\$186.02	\$219.53
2000 Series	\$105.14	\$157.13	\$157.29	\$181.40	\$175.62	\$281.92	\$281.92	\$331.60
5000 Series	\$120.16	\$181.40	\$181.40	\$207.97	\$204.51	\$329.29	\$329.29	\$387.06
6000 Series	\$142.11	\$217.22	\$217.22	\$249.57	\$243.79	\$399.77	\$399.77	\$467.94
7500 Series	\$143.85	\$222.90	\$222.90	\$256.50	\$253.30	\$410.10	\$410.10	\$480.05
9000 Series	\$161.76	\$256.50	\$256.50	\$293.47	\$291.16	\$478.34	\$478.34	\$558.06
9500 Series	\$196.42	\$284.23	\$284.23	\$329.29	\$325.82	\$536.11	\$536.11	\$622.76

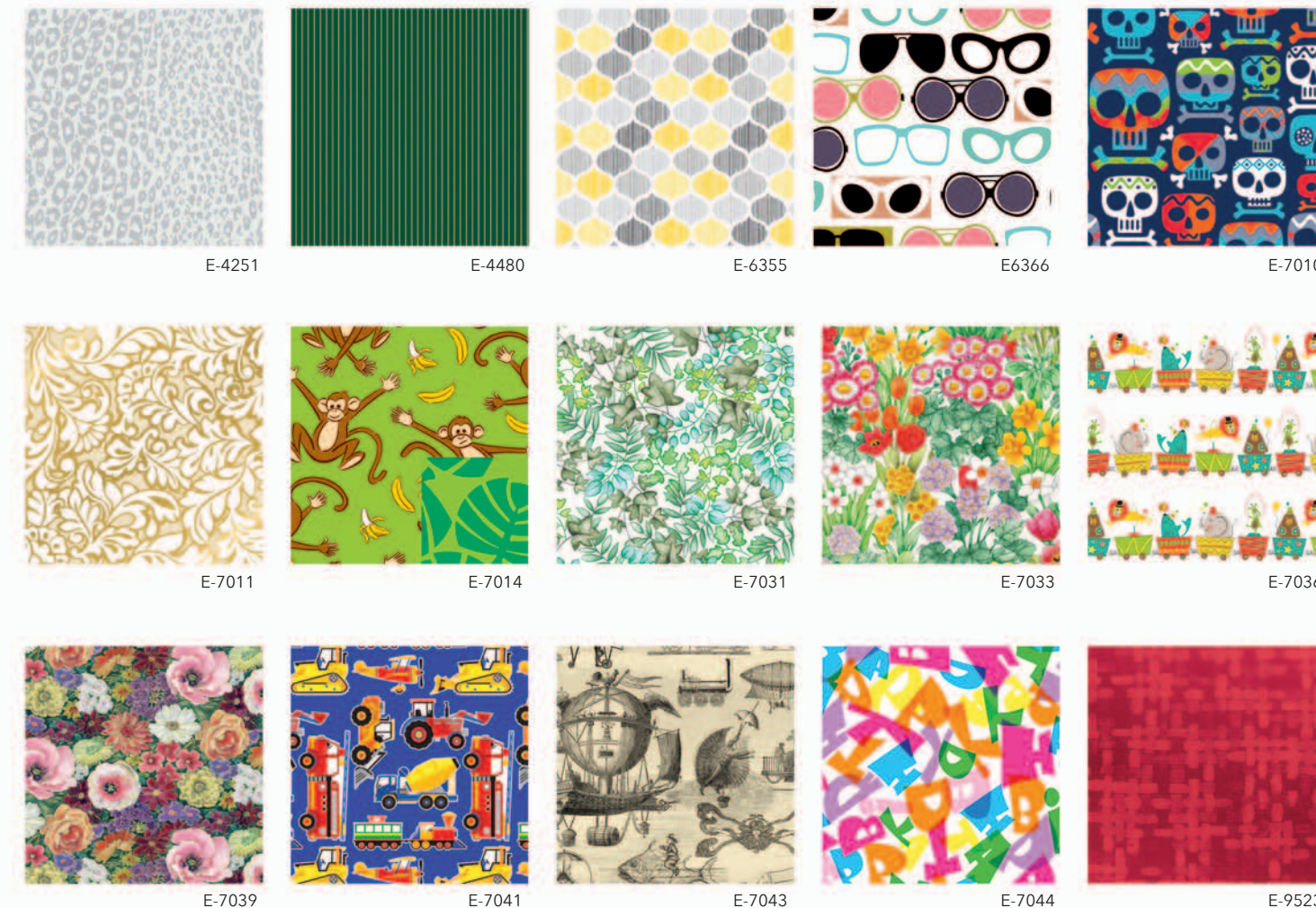

Shamrock Designs **Seasonal** Gift Wrap

Shamrock Designs **Every Day** Gift Wrap

View our entire Selection online at GUNTHERMELE.COM

Shamrock designs available in Cutter Boxes, 1/2 Ream Rolls and Full Ream Rolls

Additional custom order designs available to choose from. Contact your area sales representative for more info.

NOTE: All Shamrock giftwrap orders must include design code.

MINIMUM ORDER: 1 Roll

SLITTING CHARGE: A slitting charge of \$25.00 applies to each individual roll. (no more than two slits per roll - 2 slits = \$25.00)

Jewellers Rolls also available. Most are minimum 3 rolls per design.*

Contact your sales representative for details.* Select designs available in 1 roll minimums.

Pricing Level	7J	24C	18H	24H	30H	36H	18F	24F	30F	36F
	Jewellers Roll 7.375'x100'	Cutter Box 24" x 100'	Half Ream 18" x 417'	Half Ream 24" x 417'	Half Ream 30" x 417'	Half Ream 36" x 417'	Half Ream 18" x 833'	Half Ream 24" x 833'	Half Ream 30" x 833'	Half Ream 36" x 833'
A	\$16.20	\$32.30	\$102.60	\$93.10	\$153.90	\$153.90	\$167.20	\$157.70	\$260.30	\$260.30
B	\$20.00	\$39.90	\$127.30	\$117.80	\$193.80	\$193.80	\$218.50	\$209.00	\$345.80	\$345.80
C	\$23.80	\$47.50	\$146.30	\$136.80	\$226.10	-	\$254.60	\$245.10	\$404.70	-
D	\$25.70	\$51.30	\$157.70	\$148.20	-	-	\$279.30	\$269.80	-	-
E	\$43.70	\$87.40	\$239.40	\$229.90	-	-	\$440.80	\$431.30	-	-

Available for immediate shipment

IN STOCK

IN STOCK

Available for immediate shipment.

Color # Name	Curling Ribbon	2.75" Star Bows	3.75" Star Bows	Splendor Ribbon
00 - White				
86 - Ivory				
29 - Vanilla				
61 - Pastel Yellow				
03 - Yellow				
13 - Daffodil				
14 - Sunshine Yellow				
07 - Gold				
27 - Holiday Gold				
22 - Melon				
73 - Coral				
16 - Tropical Orange				
17 - Orange				
12 - Chocolate				
75 - Baby Pink				
01 - Pink				
80 - Primrose				
57 - Azalea				
09 - Red				
58 - Lava Red				
66 - Burgundy				
41 - Beauty				
59 - Dubonnet Rose				
28 - Orchid				
05 - Lavender				
56 - Purple				
54 - Periwinkle				
74 - Spruce				
60 - Hunter				
77 - Baby Blue				
02 - Light Blue				
48 - Williamsburg Blue				
11 - Royal				
81 - Navy				
71 - Sea Green				
47 - Aqua				
25 - Turquoise				
55 - Robin's Egg				
32 - Caribbean Blue				
84 - Teal				
04 - Mint				
19 - Citrus				
96 - Leaf				
30 - Celadon				
10 - Emerald				
93 - Charcoal				
70 - Antique Silver				
15 - Black				
07 - Metallic Gold				
08 - Metallic Silver				
09 - Metallic Red				
10 - Metallic Green				
99 - Everyday Assortment	N/A			N/A
98 - Christmas Assortment	N/A			N/A

Curling Ribbon

See chart for available colors

CODE	PRICE/ROLL
COLORS - 3/16" x 500 yards 148373 __	\$2.99
METALLIC - 3/16" x 250 yards 14837807 Gold	\$8.99
14837808 Silver	\$8.99



2.75" Splendor Bows

See chart for available colors

CODE	CASE PACK	PRICE/EACH	
		100+	1000+
COLORS - 2.75" x 17 loop 142311 __	200	\$0.0725	\$0.615
METALLIC - 2.5" x 17 loop 14531107 Gold	200	\$0.095	\$0.850
14531108 Silver	200	\$0.095	\$0.850

Min: case pack



99 - Everyday Assortment



98 - Christmas Assortment



Metallic Bows

3.75" Splendor Bows

See chart for available colors

CODE	CASE PACK	PRICE/EACH	
		100+	1000+
COLORS - 3.75" x 13 loop 143512 __	200	\$0.10	\$0.09
METALLIC - 3.75" x 17 loop 14551207 Gold	200	\$0.16	\$0.14
14551208 Silver	200	\$0.16	\$0.14



Splendor Ribbon

See chart for available colors

CODE	PRICE/ROLL
COLORS - 3/4" x 250 yards 141050 __	\$9.24
METALLIC - 3/4" x 100 yards 140130 __	\$12.60



Matte Wraphia™

CODE	SIZE	PRICE/ROLL
148367 __	100 yds	\$8.40

Perfect Bows™

Minimum: 50 per size, per color.

CODE	SIZE	PRICE/EACH	
		50+	1000+
140515 __	5.5" Perfect Bow	\$4.88	\$4.44



Mini Metallic Star Bows

252 per tub

CODE	DESCRIPTION	PRICE/TUB
14121099	Assorted	\$32.30
14121017	Gold	\$32.30
14121008	Silver	\$32.30

Pull Bows

Minimum: 100 per size, per color.

CODE	SIZE	PRICE/EACH			
		STANDARD COLORS		METALLIC COLORS	
		100+	1000+	100+	1000+
132000 __	Petite 2" Bows	\$0.166	\$0.158	\$0.256	\$0.242
134000 __	Std. 4" Bows	\$0.256	\$0.242	\$0.412	\$0.391



Paper Roll/Ream Dispenser and Tape

CODE	DESCRIPTION	PRICE
09850124	Paper Roll/Ream Roll dispenser - 24" rack	\$67.00 each
09725000	Transparent Tape 1/2" x 66 m	\$29.00/box of 12 Min. order: 1 box

Ribbon Shredder

CODE: 09878600
PRICE: \$6.99 each



Curling Ribbon Roll Dispenser

CODE: 09850100
PRICE: \$134.00 each



Holds 12 Rolls

Cellophane

CODE	DESCRIPTION	SIZE	PRICE/ROLL
16400506	Clear Cellophane	40" x 100'	\$10.50
16300506	Clear Cellophane	40" x 300'	\$23.90

Printed Satin and Grosgrain Ribbon

See chart to the right for Ribbon Colors.

WIDTH	PRICE/EA	Single Face Satin	Grosgrain
3/8" x 100 yd roll	\$47.00	14150002	14020000
5/8" x 100 yd roll	\$49.00	14150003	14020001
7/8" x 100 yd roll	\$60.00	14150005	14020002
1-1/2" x 50 yd roll	\$72.00	14150015	14020003

5 roll minimum per color.

Foil Print Colors

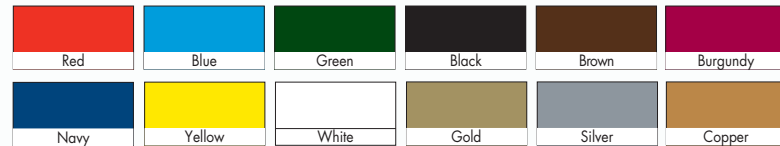

FOIL PRINT
Included in price of ribbon



Single Face Satin Ribbon with Foil Print



Grosgrain Ribbon with Foil Print
Ribbon texture not conducive to fine print.

Unprinted Satin and Grosgrain Ribbon

See chart to the right for ribbon colors.

Single Face Satin

WIDTH	CODE	PRICE/EA
3/8" x 100 yd roll	14031 ___	\$17.50
5/8" x 100 yd roll	14032 ___	\$18.10
7/8" x 100 yd roll	14033 ___	\$32.60
1-1/2" x 50 yd roll	14034 ___	\$18.10

1 roll minimum.

Grosgrain

WIDTH	CODE	PRICE/EA
3/8" x 100 yd roll	14160 ___	\$17.50
5/8" x 100 yd roll	14161 ___	\$18.10
7/8" x 100 yd roll	14162 ___	\$32.60
1-1/2" x 50 yd roll	14170 ___	\$18.10



3/8"	5/8"	7/8"	1-1/2"	Color # and Name
Single Face Satin	Grosgrain	Single Face Satin	Grosgrain	
				004 - Wheat
				007 - Shell Grey
				012 - Silver
				015 - Grey
				022 - Pewter
				028 - Antique White
				029 - White
				030 - Black
				115 - Powder Pink
				117 - Light Pink
				144 - New Nora
				150 - Pink
				151 - New Bright Pink
				156 - Hot Pink
				175 - Shocking Pink
				176 - New Shocking Pink
				186 - New Azalea
				187 - Azalea
				205 - Coral Ice
				210 - Coral Rose
				241 - Living Coral
				250 - Red
				252 - Hot Red
				255 - New Neon Pink
				260 - Scarlet
				262 - Marsala
				274 - New Maroon
				275 - Wine
				277 - Burgundy
				285 - Plum
				305 - Light Blue
				312 - Blue
				314 - New Aqua
				315 - Navajo Turquoise
				316 - Diamond
				320 - New Mystic Blue
				327 - Aegean
				328 - Island Blue
				329 - Cobalt
				330 - Tranquil Blue
				333 - Blue Bird
				340 - Turquoise
				341 - Sapphire
				343 - Tornado Blue
				346 - New Jade
				350 - Royal
				352 - Electric Blue
				353 - Century Blue
				357 - Dark Royal
				365 - Light Navy
				370 - Navy
				374 - Deep Teal
				412 - Purple Haze
				427 - Purple Wine

3/8"	5/8"	7/8"	1-1/2"	Color # and Name
Single Face Satin	Grosgrain	Single Face Satin	Grosgrain	
				430 - Light Orchid
				431 - Wild Berry
				446 - Iris Blue
				450 - Orchid
				455 - Violet
				458 - Wisteria
				462 - Royal Orchid
				464 - Delphinium
				465 - Purple
				470 - Regal Purple
				473 - Amethyst
				476 - Grappa
				505 - New Neon Yellow
				511 - New Neon Orange
				516 - Lucite
				524 - Lime Juice
				525 - Pistachio
				528 - Lemon Grass
				530 - Mint
				533 - Jungle Green
				545 - New Neon Lime
				547 - New Chartreuse
				548 - Kiwi
				550 - Apple Green
				558 - Leaf
				567 - Spring Moss
				570 - Moss
				580 - Emerald
				586 - New Neon Green
				587 - Forest Green
				617 - Baby Maize
				640 - Lemon
				645 - Daffodil
				650 - Maize
				660 - Yellow Gold
				675 - Gold
				690 - Old Gold
				722 - Burnt Sienna
				725 - New Apricot
				743 - Ginger
				739 - Adobe
				750 - Torrid Orange
				761 - Autumn Orange
				780 - Rust
				789 - Sherry
				790 - Currant
				810 - Ivory
				815 - Cream
				825 - Natural
				835 - Tan
				841 - Khaki
				850 - Brown
				866 - Coffee
				871 - Milk Chocolate

While we strive for accuracy in our catalog, actual product may be slightly different than pictured.

Simply Sheer Asiana Ribbon

Monofilament-Edge



CODE	SIZE	PRICE/ROLL
149435 __	7/8" x 100 yards	\$11.40
149436 __	1 1/2" x 100 yards	\$12.50

• minimum order: one roll



Raised Ink Printing

See chart below for ribbon colors.

Pick your own colors for raised print - NO PLATE CHARGE

WIDTH	PRICE EACH	Single Face Satin CODE	Grosgrain CODE	Sheer CODE
5/8" x 100 yd roll	\$44.00	14140039	14150042	14140045
7/8" x 100 yd roll	\$47.00	14140040	14150043	14140046
1-1/2" x 50 yd roll	\$83.00	14140041	14150044	14140047

40 roll minimum for all printed ribbon.

Contessa Ribbon

Wire-Edge Single Face Satin



CODE	SIZE	PRICE/ROLL
14163 ___	1 1/2" x 25 yards	\$14.00
*14164 ___	2 1/4" x 25 yards	\$21.00

• minimum order: one roll



* 2-1/4" is only available in 029-White, 260-Scarlet, 643-Buttercream and Ivory (810).

Encore Ribbon

Wire-Edge



CODE	SIZE	PRICE/ROLL
141650 __	5/8" x 25 yards	\$6.10
141660 __	1 1/2" x 25 yards	\$12.20
141670 __	2 1/2" x 25 yards	\$18.25

• minimum order: one roll



* not available in 5/8"
† not available in 2 1/2"

Garbo Ribbon



CODE	SIZE	PRICE/ROLL
14168 ___	5/8" x 100 yards	\$46.30
14169 ___	1 1/2" x 50 yards	\$35.80

• minimum order: one roll

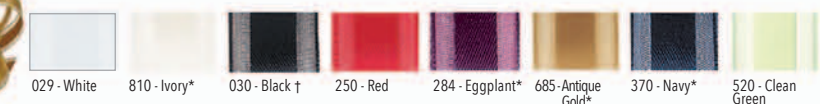

* not available in 5/8"
† not available in 1 1/2"

Sheer Ribbon Colors

All colors are available in all sizes. See page 119 for single face satin and grosgrain color availability.



Single Face Satin Ribbon with Raised Print



Sheer Ribbon with Raised Print



Grosgrain Ribbon with Raised Print

Please allow 2 - 3 weeks for printed items from approved art.

IN STOCK

IN STOCK

Please allow 2 - 3 weeks for printed items from approved art.



FOIL PRINT
Included in the price.
Please allow 2-3 weeks for printing.

Customized Seals-Foil Printed

CODE	SIZE	One color foil print/each		Two color/each		Acetate 1 color/each		Acetate 2 color/each	
		2000+	5000+	2000+	5000+	2000+	5000+	2000+	5000+
25 4 digit label code 2 digit label color	A	\$0.088	\$0.082	\$0.140	\$0.110	\$0.160	\$0.125	\$0.183	\$0.142
	B	\$0.100	\$0.090	\$0.150	\$0.120	\$0.192	\$0.151	\$0.220	\$0.176
	C	\$0.120	\$0.110	\$0.165	\$0.134	\$0.229	\$0.176	\$0.258	\$0.210
	D	\$0.135	\$0.120	\$0.172	\$0.143	\$0.283	\$0.227	\$0.310	\$0.244
		\$65 plates		\$95 plates		\$65 plates		\$95 plates	

Label Colors Available:

06 Clear	00 White	17 Met. Gold	18 Met. Silver	15 Black	07 Mat Gold	08 Mat Silver	10 Dark Green
----------	----------	--------------	----------------	----------	-------------	---------------	---------------

See foil chart on inside back cover of catalog for available print colors.

Pre-printed Labels

CODE	SIZE	CASE	PRICE/EACH	
			1000+	5000+
25401007S	5/8 x 3/8"	1000	\$0.088	\$0.082
25401407S	5/8 x 3/8"	1000	\$0.088	\$0.082
25406208S	5/8 x 3/8"	1000	\$0.088	\$0.082
25401007V	3/4" oval	1000	\$0.088	\$0.082
25401407V	3/4" oval	1000	\$0.088	\$0.082
25406008S	3/4" oval	1000	\$0.088	\$0.082

1000/box minimum order - 1 box of 1000.

For a no-print solution, order our in stock Embossed Seals

Embossed Seals

500/box min. order - 1 box.

CODE	SIZE	PRICE/EA
Gold 08701207	1.5" dia.	\$0.0400
Silver 08701208	1.5" dia.	\$0.0400

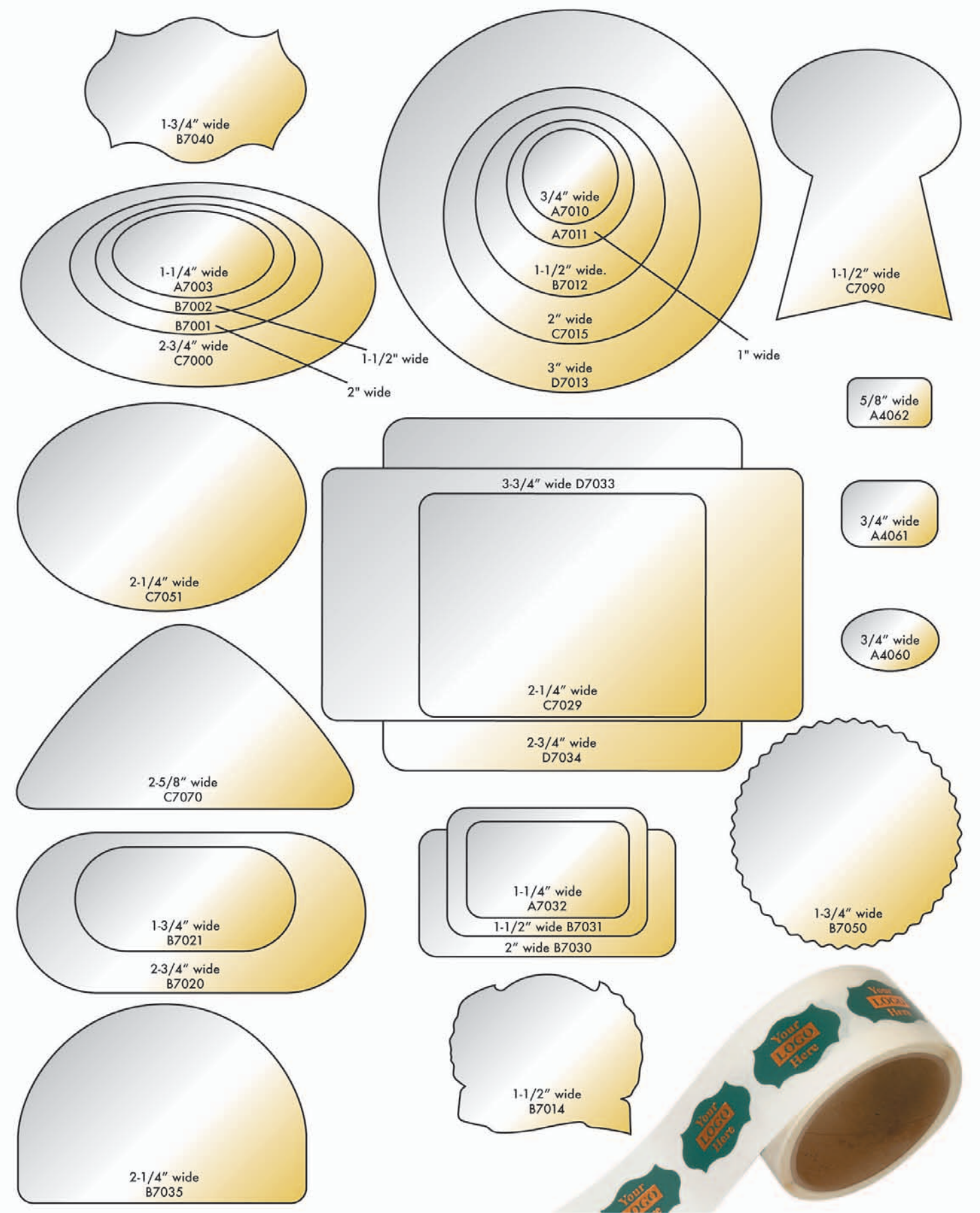
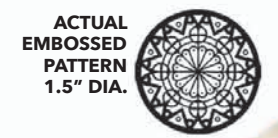

Please allow 4 - 6 weeks for printing from approved art. NO PLATE CHAGE!

CREATE YOUR OWN LOOK

CREATE YOUR OWN LOOK

Please allow 4 - 6 weeks for printing from approved art. NO PLATE CHAGE!

* Artwork charges will apply.
* Set-up charge \$30.00



ALL PRICES ARE PER EACH

Group	1000	2000	3000	5000	10000
1	\$0.2288	\$0.1188	\$0.0814	\$0.0594	\$0.0415
2	\$0.2310	\$0.1210	\$0.0836	\$0.0616	\$0.0476
3	\$0.2332	\$0.1232	\$0.0858	\$0.0638	\$0.0547
4	\$0.2354	\$0.1254	\$0.0902	\$0.0682	\$0.0610
5	\$0.2970	\$0.1804	\$0.1298	\$0.0946	\$0.0668
6	\$0.3630	\$0.2354	\$0.1694	\$0.1188	\$0.0738
7	\$0.4202	\$0.2948	\$0.2090	\$0.1210	\$0.0800
8	\$0.4356	\$0.2990	\$0.2112	\$0.1320	\$0.0871
9	\$0.4510	\$0.3058	\$0.2134	\$0.1474	\$0.0953
10	\$0.4686	\$0.3102	\$0.2178	\$0.1496	\$0.1014
11	\$0.4840	\$0.3146	\$0.2222	\$0.1518	\$0.1063
13	\$0.5016	\$0.3256	\$0.2288	\$0.1606	\$0.1195
16	\$0.5302	\$0.3410	\$0.2442	\$0.1716	\$0.1388
17	\$0.5390	\$0.3542	\$0.2530	\$0.1782	\$0.1459
19	\$0.5610	\$0.3850	\$0.2750	\$0.1914	\$0.1591
21	\$0.5830	\$0.4026	\$0.2948	\$0.2046	\$0.1723
22	\$0.5962	\$0.4070	\$0.3036	\$0.2112	\$0.1784
24	\$0.6182	\$0.4180	\$0.3190	\$0.2222	\$0.1916
27	\$0.6490	\$0.4422	\$0.3476	\$0.2662	\$0.2108
29	\$0.6710	\$0.4554	\$0.3652	\$0.2948	\$0.2240
30	\$0.6842	\$0.4642	\$0.3784	\$0.3102	\$0.2311

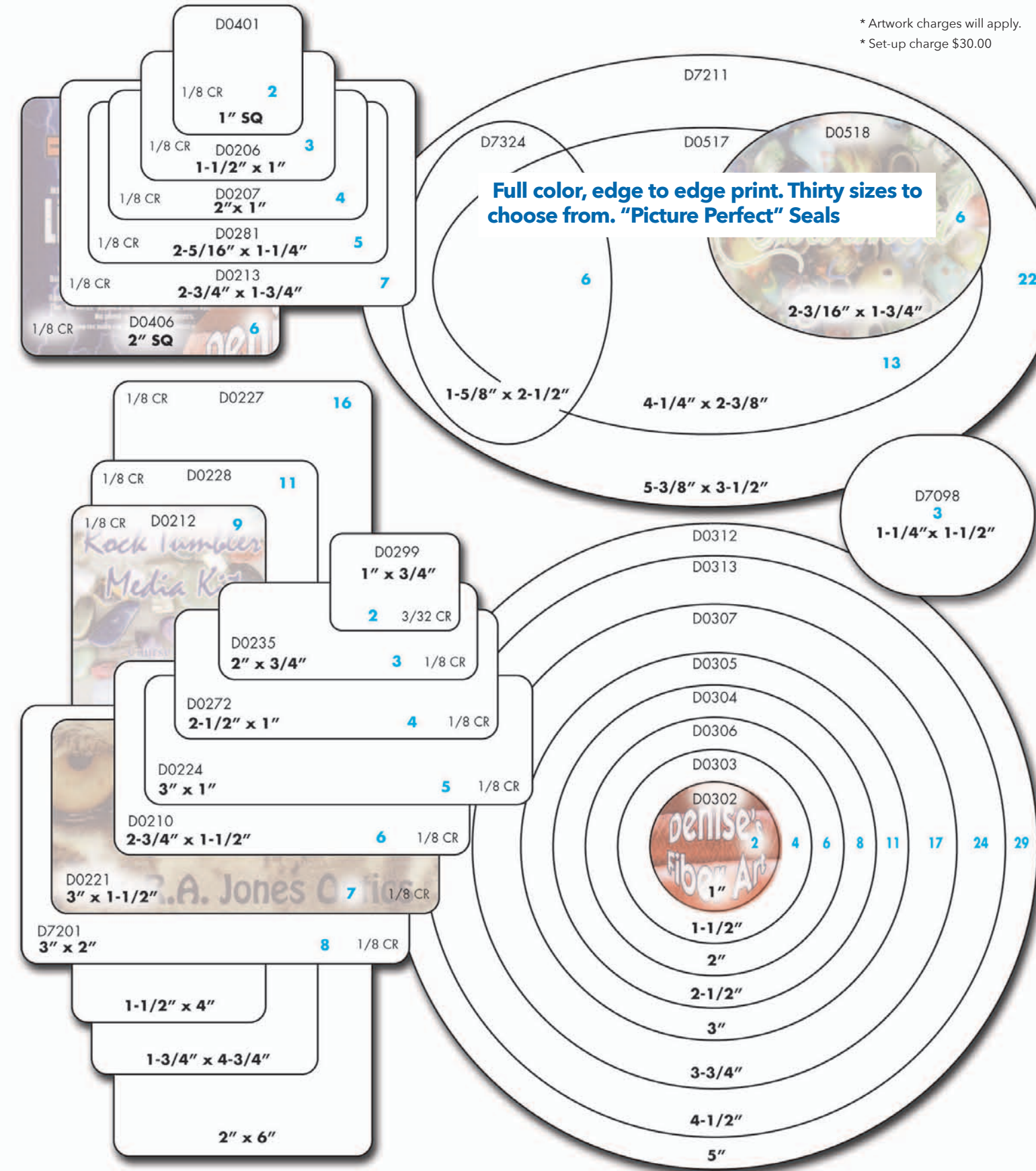
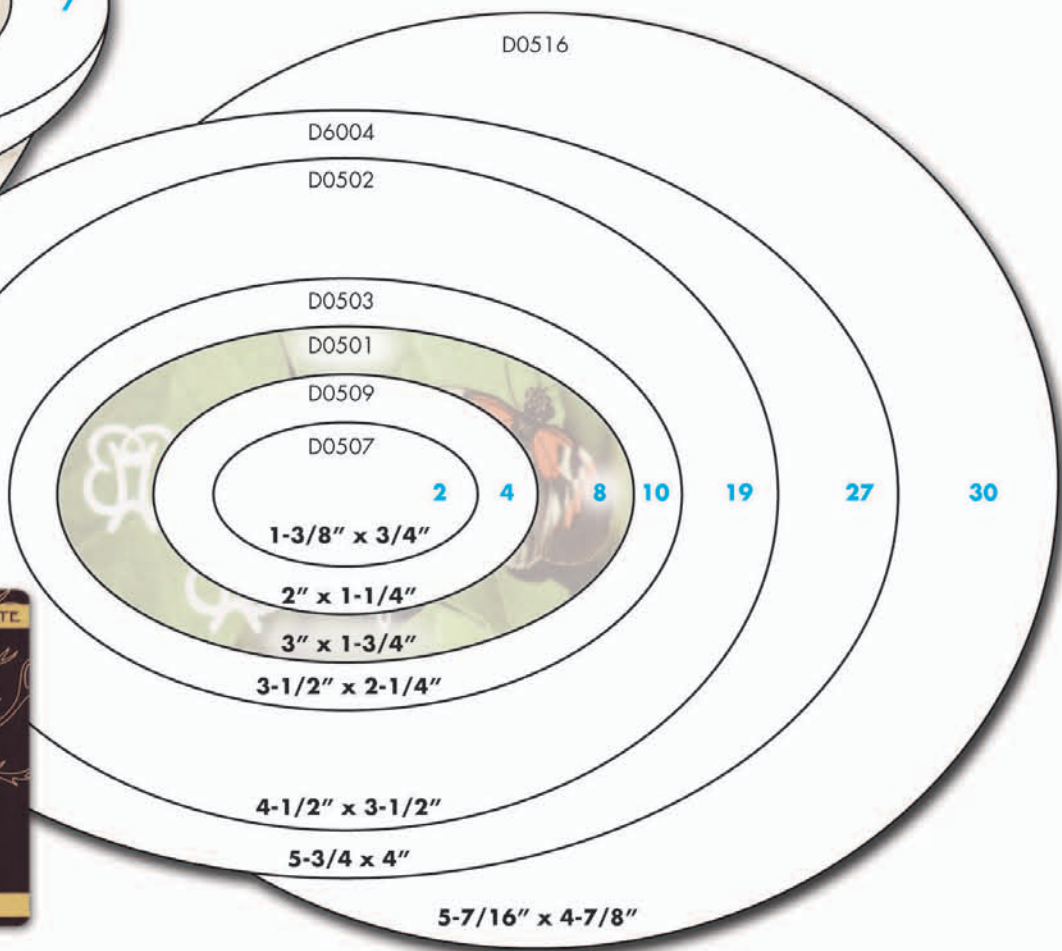

PRINTING INFORMATION

Have your name and logo printed... it's easy!

1. Select your box or bag style, color and size.

2. Choose the printing method you wish to use.



A. **FOIL PRINTING:** Foil is applied to the bag or box using a combination of heat and pressure on a magnesium print plate to create an elegant appearance. Choice of Metallic or Matte foils. Cost of Foil Printing Print plate per size and color - \$70.00 (maximum 30 square inches)



B. **PAD PRINTING:** Ink is applied to smooth surfaces allowing us to print your logo in places never before possible. Cost of Pad Print plate per size and color - \$80.00 (maximum 3.75 square inches)



C. **INK IMPRINTING:** Ink is applied to the box or bag using a rubber printing plate. This method is ideal for larger coverage imprints and is economically priced. Cost of Ink Printing Plate per size per color starting at \$110.00. (maximum 25 square inches)



D. **SILK SCREEN:** Die fast ink is applied to Fabric Style Bags through a screen. The process allows the ink to permeate into the fabric dimples for optimal coverage. Screen charge of \$65.00 applies with each order.



E. **FULL COLOR DIGITAL PRINTING:** Utilizing the latest 4-color process technology, we now offer full color digital printed graphics on fabric and nylon bags using a heat press process. This full color digital printing creates a transfer that allows for vibrant images on both lights and darks. Pricing is the same regardless of the amount of colors used in a design. Have your full color image applied to your bags for just \$0.90 per bag (minimum 300 bags)



F. **DEBOSSING:** Using a metal plate die, debossing produces an image that's pressed into the material and indented. No colour is involved. Cost of metal plate starts at \$70.00 (maximum 70 square inches.)

3. Choose the Imprint Color

When Foil Printing, select from 34 foil colors in 3 different finishes: Metallic (High Sheen or Matte), Flat, or Pearlized. For ink printing select from our 8 Standard colors for in stock items, or ask about Pantone Matching for Special Order items such as Simply Bags and Fabric Style Bags.

4. Send us your artwork.

If you are a new print customer, send us your artwork by e-mail or on computer disk. Artwork must be high resolution (300 dpi) and pre-sized to scale. Please contact our customer service or graphics department for acceptable file formats. 'Camera Ready' artwork is also accepted; photocopies and facsimiles are NOT acceptable as camera ready art.

If you don't have artwork or your artwork needs adjustments, we have a talented design team who can assist you. Contact one of our sales representatives or email us your ideas today. For pricing, see the artwork charges section.

Acceptable Artwork Formats

- Vector files (preferred): Adobe Illustrator with .ai, .eps, or .pdf file extension
- Raster files: (ie. PDF, PSD, TIF, or JPEG) Higher Resolution at 300dpi or more. Please note: ALL raster formats will be subject to additional art charges as in most cases it will have to be converted to a vector to meet our requirements.
- Please include fonts (.ttf) or convert fonts to outlines when sending ANY Illustrator file.

The following formats are NOT acceptable

- Publisher (.pub) • CorelDraw (.cdr) • small GIF or BMP internet images
- Any Word or spreadsheet documents - '.docx', '.xls', '.wpd', '.od'

If unsure about any format including "what is a vector" please send all inquiries to your inside Customer Service & Cc: graphics@gunthermele.com

OTHER PRINTING COSTS

Artwork Charges: As mentioned above, we have a talented creative team that can work with you to design, create, manipulate or re-size your store logo or name. Artwork service is charged at a rate of \$70.00/hour.

Set-up Charges: Every print job requires a machine to be set-up, and a charge of \$30.00 will be applied to every printed order. Please note: multiple print sizes of the same logo require multiple set-ups.

Plate Charges: Plate charges apply one-time only. Each time you require a 'new' print design (i.e. Logo change, Print Size Adjustment etc.) a new plate must be created. Once the plate is made, we will hold it for you in our warehouse and it will be available for all future printing requirements. Plate charges range in cost from \$70.00 for a Foil Printing plate to \$110+ for an Ink Printing Plate. (maximum 25 square inches)

FOIL STAMPING COLORS

Metallic Options

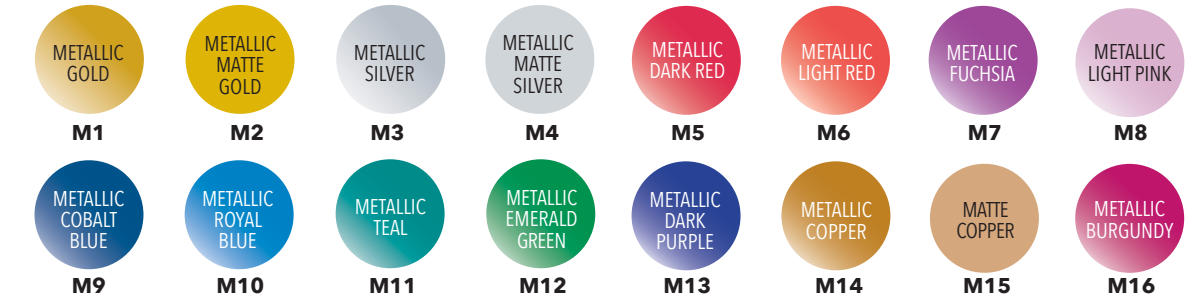

Metallic options feature a high sheen finish unless otherwise indicated as matte finish.

Flat Options



Pearlized Options Printable only on white.



Satine Foil Colors



INK IMPRINTING COLORS

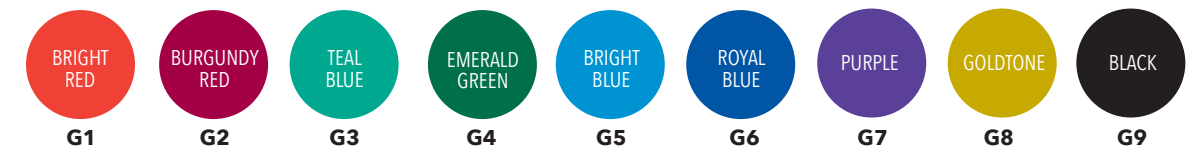

PAD IMPRINTING COLORS

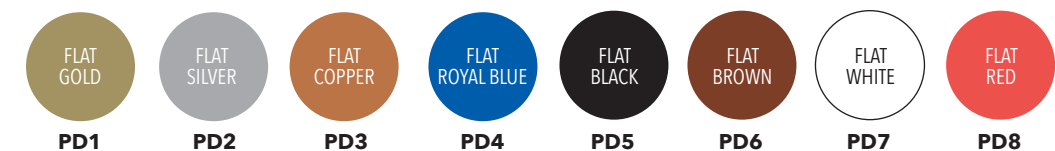

Colors shown are representations only and may not reflect true production colors.

GUNTHERMELE 1857

TO PLACE AN ORDER

Call Customer Service: 716.821.1472
Toll Free: 1.800.516.0108
Order on line: gunthermele.com
Direct Fax: 716.821.1480

FOR EASY PAYMENT OPTIONS

- Order online and pay with your credit card at gunthermele.com.
- We accept all major credit cards.
- Payments may also be made via on line, banking by selecting "Gunther Mele" as a payee.



Sign up for paperless billing. See our website for more information.



**A Revolution In
Jewelry Packaging.**

TERMS AND CONDITIONS:

- Minimum order \$250.00.
- F.O.B point: Buffalo, N.Y., U.S.A.
- Net 30 days O.A.C.
- New account payment terms: Visa or MasterCard 50% deposit with order, balance due upon shipping.
- Defective merchandise will be accepted back for credit only if claimed within 15 days of receipt of shipment. Authorization number must be obtained by contacting our customer service department 1-800-516-0108.
- In-transit damages and shortages must be claimed with the freight carrier at time of delivery.
- All lead times are estimates only (from receipt of approved artwork and credit) and are not guaranteed.
- Plate charges where applicable are:
 - Foil Print Dies: \$45.00 per size (maximum 30 square inches)
 - Pad Dies: \$80.00 per size (maximum 3.75 square inches)
 - Ink Plates \$110.00 + (maximum 25 square inches)
- While we strive for accuracy in our catalog, actual product may be slightly different than pictured.
- Prices subject to change without notice.