

JEWELRY PACKAGING GUIDE

2022 -2023 • VOLUME 164





OUR VISION

“Helping our customers tell their unique brand story while providing a customer experience like no other.”

– Darrell King, President

Welcome to our new packaging guide – our 165th version since our founding in 1857.

We have some exciting developments in the following pages. Most of the changes we have ushered in this year are centered around a more sustainable approach to our business with an emphasis on the materials we use and the reusability of our products. We have begun to view all of our products through this new lens of eco-minded sustainability. We call this our “**Mission Green**”.

Mission Green drives us to use materials that are either from recycled or sustainable sources. It also focuses us on a vastly overlooked practice in sustainability: reusability.



RECYCLED

There are two important terms that classify the source of recycled content. These are: post-consumer waste and post-industrial waste.

Post-consumer waste (PCW). Wherever possible, we are using paper and now plastics that are derived, at least partially if not fully, from municipal recycling programs and this term post-consumer implies that it has been recovered after consumer use.

Post-industrial waste (PIW). Another key source of recycled material. In this instance, scrap material is diverted from the landfill and recycled into new material to be used in production.

Product Examples include: our brand new, Canadian made paper twist shoppers made from paper that is derived from 96% post-consumer waste. Our new “resuede” is a luxurious recycled material that feels like plush suede but is produced using recycled materials to create a luxury look and feel. We feature our resuede material in our new drawer series box (page 39) and our new Eco series of hinged boxes (page 27)

SUSTAINABLE

FSC – Forestry Stewardship Council. In short, this governing body oversees wood and pulp (paper) products derived from responsibly managed forests. This global governing body is an intricate certification process that verifies paper and its sources. In the instances where paper needs to come from new pulp source, we are choosing to use papers that carry the widely recognized FSC designation.

REUSABLE

Jewelry packaging has an inherent keepsake quality. Most people will collect jewelry boxes for storage and sentimental value. We have also been studying consumer behavior and there is demand for an after use of jewelry packaging. Our active lifestyles and thirst for travel dictates the need to store and protect jewelry when it is not being worn. With that, we have introduced our new Nano™ collection of luxurious and practical travel pouches that not only present the jewelry exquisitely but also doubles as ongoing storage and protection for our society who is always on the go.

In nearly every category we have exciting new products that meet our Mission Green criteria. These are just the first steps of our journey toward more sustainable and eco-conscious packaging solutions and we hope you’ll join us on this important journey.



Signature Velvet Series

Plush black velvet hinged boxes accented with suede pads and bengaline trim detail
See page 17



EcoBox Hinged

50% recycled material plastic shell
resuede interior
See page 27



Drawer Box

100% recyclable paper board with
resuede pads and pulls
See page 39



Deco Box

Recycled paperboard
See page 41



CYOL 6 Easy Pieces Hinged Packaging

with coordinating eurototes
See page 28



All Paper Shopper

100% recyclable / 40% post
consumer waste
See page 79



RPET REUSABLES

Mission Green - sustainable 80% woven
recycled RPET laminated tote
See page 91



Paper Twist

Mission Green - 100% recyclable
See page 85

CYOL

Made to Order Jewelry Display



IN STOCK

Jewelry Display



Platforms and Risers

Ring Showcase

Pendant & Earring Stands

Neck Forms & Bracelet Stands

Trays, Counter Pads,
Chain Ramps

Open Stock and Prepacks
Available

**Save 25% when you buy
\$500 or more!**

Tell your brand story
Create your unique identity

Elevate the
shopping experience

Drive more sales

**Complimentary
Display Design**

Financing Programs Available

*Complete set of renderings available with payment of deposit.
Deposits will be deducted from invoice at time of billing.



PROPOSAL

Ring Presentation



Ring Stash

The solution to bulky engagement ring boxes.

- Discreet compact size
- Flexible ring clip firmly holds the ring in place
- Magnetic closure
- Light weight and durable
- Black sleeve packer
- Printing options available
- U.S. Patent #9375066

68021015L
2.32" x 2.44" x .55
12/case

Minimum order 12.
Estimated lead time: 2 - 3 weeks for printed items from approved art.

You've sold the perfect ring.
They've planned the perfect moment.

Help them keep it a secret.

 **FOIL / PAD PRINT**
F: inside liner / PP: top lid only
12+ 32¢ each
144+ 29¢ each
504+ 24¢ each

PROPOSAL

Ring Presentation



Proposal Ring Hinged Box

- Single ring box with matching ribbon pull accent and ring clip
- Brushed ivory linea interior
- White sleeve packer
- Minimum case pack 12

36220 ____
2.36" x 2.36" x .94"
12+ and 144+

Estimated lead time: 2 - 3 weeks for printed items from approved art.

 **FOIL / PAD PRINT**
F: inside top liner
PP: inside top liner and top lid
12+ 32¢ each
144+ 29¢ each
504+ 24¢ each

873B - Bronze



Sweetheart Box

See page 31



Nano Clutch

See page 38



TABLE OF CONTENTS

Jewelry Packaging

Proposal Ring Specialty Boxes	8 - 9	Nest Boxes	46 - 48
Hinged Packaging	12 - 39	Jewelry Folders	38 and 49
New Signature Series	17	Create Your Own Look Details	50 - 51
ECO EcoBox	27	Gift Card and Certificate Boxes	52 - 53
Vantage	29	Pouches	54 - 55
ECO Drawer Box	39	New Jewelry Cloths and Cleaners	56 - 57
Paperboard Jewelry Packaging	40 - 45	Repair Envelopes and Tags	58

Jewelry Display

Create Your Own Look Element and Showcase Platform Styles	60 - 61	In Stock Jewelry Displays	64 - 72
Create Your Own Look Fabrics and Color Options	62 - 63		

Jewelry Storage by Mele & Co.

Stowaway Line and Highlights	74
------------------------------------	----

Bags

Vantage, Eclipse and Geo Eurototes	76	New ECO Food Service Kraft Bags	87
Rope Handle Paper Totes	77	Custom Printed Poly Shopping Bags	88
Grosgrain Handle Eurototes	78	Frosted Poly	89
ECO All Paper Eurototes	79	Poly Merchandise Bags	89
CYOL Rope Handle	80	Custom Full Color Reusable	90
5th Avenue Eurototes	81	ECO RPET Reusable Bags - Recycled Bottles ..	91
Manhattan Eurototes	82	New Upcycle and Toronto Laminated Totes ...	92
New Totally Trim and Color Paper Shoppers .	83	In Stock Reusable Fabric Shoppers	93
ECO CYOL Simply Paper Shoppers	84	Apparel Bags	94
Paper Twist Handle and Damask	85		
ECO Kraft Die Cut Handle and Merchandise ..	86		

Gift Boxes and E-Commerce

Malibu Magnetic Gift Box	96	CYOL E-Com Boxes and Mailers	100
Tuckit® Boxes	96	New In Stock E-Com Boxes for Gift & Apparel..	101
White Folding Gift Boxes	97	In Stock E-Com Boxes for Jewelry	101
Apparel Boxes	97	In Stock and S/O E-Com Mailers	102

Finishing Touches

Tissue Paper	104 - 105	Printed and Unprinted Ribbon	114 - 117
New Inspirations Gift Wrap	106 - 107	In Stock Seals - Foil Print	118 - 119
Jewelers Rolls	109	Custom Seals - Full Color	120 - 121
Special Order Gift wrap	108 - 111	Print Information and Colors	122 - 123
Bows, Cellophane & Dispensers ...	112 - 113		

JEWELRY PACKAGING



CREATE YOUR OWN LOOK

JEWELRY PACKAGING



WOOD SERIES

The possibilities are endless when you choose wooden materials. Endless and timeless, in terms of size, shape, finish and color. High-end style, this collection features our Monterey series shape with a high gloss white finish, black "reveal" edge and black linea interior. Add a matching custom tote bag to complete the look.

IN STOCK

Hinged Boxes

JEWELRY PACKAGING



**COORDINATING
EUROTOTES**
See pages 77

Available Colors



Outer Box
150MC - Black Gloss



Outer Box
320M - Mahogany



**150MCB -
OPTIONAL
BLACK INTERIOR
RING BOX ONLY**

Monterey II

Wood series with modern lines and a gloss finish.

- Soft white leatherette interior
- Packaged in a 2-piece white traditional outer box

CODE	DESCRIPTION	SIZE (inches)
36821	Ring (R1)	2.375 x 2.375 x 2
36822	Earring (E1)	2.375 x 2.375 x 2
36843	Utility T-pad (ET14)	4 x 4 x 2
36850	Watch (PL1)	4.375 x 4.375 x 2.75
36893	Bracelet (BL1)	9.5 x 2.375 x 1.5
36813	Necklace (N2)	7.5 x 7.5 x 2

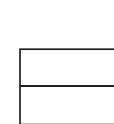

R1
SLOTTED RING PAD

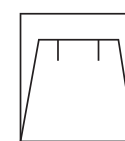

E1
DIE CUT EARRING/PENDANT PAD

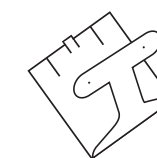

ET14
T FLAP PENDANT/EARRING PAD

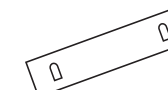

BL1
BRACELET PAD (metal clip)
GLUED PAD

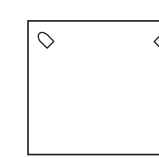

N2
NECKLACE PAD GLUED

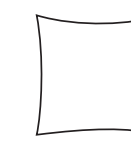

PL1
WATCH PILLOW



FOIL / PAD PRINT
F: inside liner and packer lid / PP: all 3 locations
12+ 32c each
144+ 29c each
504+ 24c each

Minimum 12 per style.
Please allow 2 - 3 weeks for printed items from approved art.

All print orders subject to set-up charges. Applicable artwork, and plate charges may apply. See page 122.

CREATE YOUR OWN LOOK

JEWELRY PACKAGING



WHISPER SERIES

Our modern luxury box is shown here in a stylish textured gold paper called: Shuttle. Matching interior and pads create a seamless look.

IN STOCK

Hinged Boxes

JEWELRY PACKAGING



**COORDINATING
EUROTOTE**
See page 78

Available Colors



Outer Box
559W - Carbon Black



Outer Box
009W - Moon Glow



Outer Box
289W - Palladium

Whisper

Elegant curves and round corners.

- Monochromatic metallic pinsketch linea fabric
- Packaged in a coordinating 2-piece outer box

CODE	DESCRIPTION	SIZE (inches)
36821	Ring (R1)	2.375 x 2.375 x 2.125
36822	Earring (E1)	2.375 x 2.375 x 2.125
36823	Large Ring (R1)	3.25 x 3.25 x 2.25
36883	Utility T-pad (ET14)	3.25 x 3.25 x 2.25
36850	Watch (PL1)	4 x 4 x 2.75
36893	Bracelet (BL1)	9.25 x 2.5 x 1.75
36873	Necklace (N2)	6.5 x 8 x 1.75

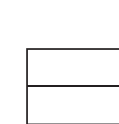

R1
SLOTTED RING PAD

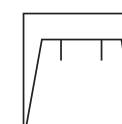

E1
DIE CUT EARRING/PENDANT PAD



ET14
T FLAP PENDANT/EARRING PAD

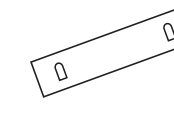

BL1
BRACELET PAD (metal clip)
GLUED PAD

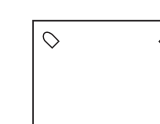

N2
NECKLACE PAD GLUED

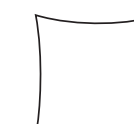

PL1
WATCH PILLOW



FOIL / PAD PRINT
F: inside liner and packer lid / PP: all 3 locations
12+ 32¢ each
144+ 29¢ each
504+ 24¢ each

Minimum 12 per style.
Please allow 2 - 3 weeks for printed items from approved art.

All print orders subject to set-up charges. Applicable artwork, and plate charges may apply. See page 122.

CREATE YOUR OWN LOOK

IN STOCK Hinged Boxes

JEWELRY PACKAGING

JEWELRY PACKAGING



**COORDINATING
EUROTOTE**
See page 78



Outer Box

Signature Series

This modernized classic is a must have.

- Plush black velvet hinged boxes accented with suede pads and bengaline trim detail
- Packaged in a coordinating 2-piece outer box

CODE	DESCRIPTION	SIZE (inches)
36521151	Ring (R1)	1.96 x 1.96 x 1.96
36522151	Pendant/Earring (E1)	2.36 x 2.36 x 2.28
36583151	Utility (PL1 or T3)	3.93 x 3.93 x 2.36
69550151	Pillow (PL1)	
69583151	Triple Flip Pad (T3)	
36573151	Necklace (N3)	7 x 7 x 1.77

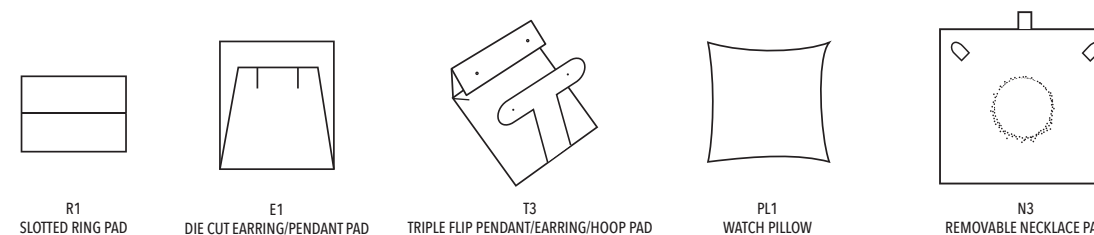

R1 SLOTTED RING PAD E1 DIE CUT EARRING/PENDANT PAD T3 TRIPLE FLIP PENDANT/EARRING/HOOP PAD PL1 WATCH PILLOW N3 REMOVABLE NECKLACE PAD

VELVET SERIES

Plush velvet hinged boxes accented with suede pads and bengaline trim detail.



FOIL / PAD PRINT
F / PP: inside liner and packer lid
12+ 32¢ each
144+ 29¢ each
504+ 24¢ each

Minimum 12 per style.
Please allow 2 - 3 weeks for printed items from approved art.

All print orders subject to set-up charges. Applicable artwork, and plate charges may apply. See page 122.

CREATE YOUR OWN LOOK

JEWELRY PACKAGING



ECLIPSE SERIES

This eclipse collection features an elegant champagne custom embossed covering with an ivory shimmer interior and gold printed logo on the top liner. The custom rope handle tote completes this beautiful collection.

IN STOCK Hinged Boxes

JEWELRY PACKAGING



COORDINATING
EUROTOTE
See page 76

Available Colors



Outer Box

813 - Linea Blue Celestial



Outer Box

663 - Linea Aubergine



Outer Box

423 - Brown



50% Recycled Shell

Eclipse

Classic square corners with a distinctive crescent style front.

• Packaged in full-depth 2-piece outer box

CODE	DESCRIPTION	SIZE (inches)
36821 ___	Ring (R1)	2.5 x 2.5 x 1.75
36822 ___	Earring/Pendant (E1)	2.5 x 2.5 x 1.75
36883 ___	Utility T-pad (ET14)	3.75 x 4 x 1.75
36893 ___	Bracelet (BL1)	9.25 x 2.5 x 1.75
36873 ___	Necklace (N2)	6.5 x 8 x 1.75
36850 ___	Watch (PL1)	3.75 x 4.25 x 3

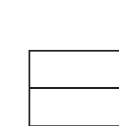

R1
SLOTTED RING PAD

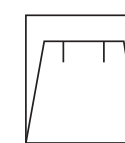

E1
DIE CUT EARRING/PENDANT PAD

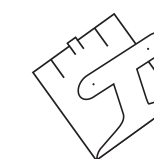

ET14
T FLAP PENDANT/EARRING PAD

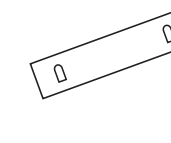

BL1
BRACELET PAD (metal clip)
GLUED PAD

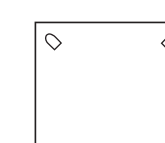

N2
NECKLACE PAD GLUED

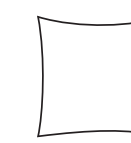

PL1
WATCH PILLOW



See page 50.



FOIL / PAD PRINT

F: inside liner and packer lid / PP: all 3 locations
12+ 32¢ each
144+ 29¢ each
504+ 24¢ each

Minimum 12 per style.
Please allow 2 - 3 weeks for printed items from approved art.

All print orders subject to set-up charges. Applicable artwork, and plate charges may apply. See page 122.

IN STOCK

Hinged Boxes

JEWELRY PACKAGING



COORDINATING EUROTOTE
See pages 77



50% Recycled Shell

Available Colors



Outer Box

114 - Blue

Outer Box

674 - Green

Estate

Contemporary style with a touch of tradition.

- White velvet pads and satin top liners
- Packaged in a coordinating 2-piece outer box

CODE	DESCRIPTION	SIZE (inches)
36021 ___	Ring (R1)	2 x 2.25 x 1.875
36022 ___	Earring (E1)	2 x 2.125 x 1.625
36084 ___	Utility T-pad (ET14)	3.5 x 3.5 x 1.5
36093 ___	Bracelet (BL1)	8.5 x 2.125 x 1
36073 ___	Necklace (N2)	7.125 x 4.375 x 1.25



R1
SLOTTED RING PAD

E1
DIE CUT EARRING/PENDANT PAD

ET14
T FLAP PENDANT/EARRING PAD

BL1
BRACELET PAD (metal clip)
GLUED PAD

N2
NECKLACE PAD GLUED



FOIL / PAD PRINT

F: inside liner and packer lid / PP: all 3 locations
12+ 32¢ each
144+ 29¢ each
504+ 24¢ each

Minimum 12 per style.
Please allow 2 - 3 weeks for printed items from approved art.



See page 50.

IN STOCK

Hinged Boxes

JEWELRY PACKAGING



COORDINATING EUROTOTE
See page 81



50% Recycled Shell

Available Colors



Outer Box

OPTIONAL BLACK INTERIOR AVAILABLE
153B - Black on Black

Roma

Distinctive round corner styling with sculpted sides.

- Lizard style embossed covering with leatherette interior
- Packaged in a 2-piece coordinating outer box with ¼ depth lids

CODE	DESCRIPTION	SIZE (inches)
36421 ____	Ring (R1)	2.25 x 2.25 x 1.75
36422 ____	Earring (E1)	2.25 x 2.25 x 1.75
36484 ____	Utility T-pad (ET14)	3.75 x 3.75 x 2
36493 ____	Bracelet (BL1)	9.375 x 2.25 x 1.5
36477 ____	Necklace (N3)	7.5 x 7.5 x 2.125

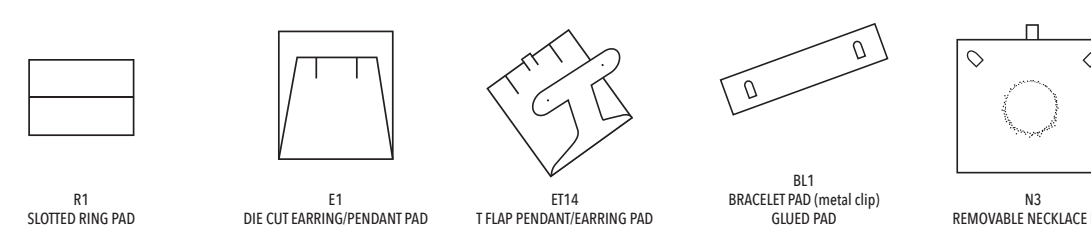

R1
SLOTTED RING PAD

E1
DIE CUT EARRING/PENDANT PAD

ET14
T FLAP PENDANT/EARRING PAD

BL1
BRACELET PAD (metal clip)
GLUED PAD

N3
REMOVABLE NECKLACE PAD



FOIL / PAD PRINT

F: inside liner and packer lid / PP: all 3 locations
12+ 32¢ each
144+ 29¢ each
504+ 24¢ each

Minimum 12 per style.
Please allow 2 - 3 weeks for printed items from approved art.



See page 50.



50% Recycled Shell

All print orders subject to set-up charges. Applicable artwork, and plate charges may apply. See page 122.

All print orders subject to set-up charges. Applicable artwork, and plate charges may apply. See page 122.

CREATE YOUR OWN LOOK

JEWELRY PACKAGING



GEO SERIES

A series completely unique with added top stitching to the covering and upgrading the fabric to a luxurious grey leatherette. This Geo collection features a debossed logo on the top of the lid. Matching dark interior pads create a seamless look to showcase fine pieces. Packaged in two-tone 3/4 depth outer box with a silver embossed print. This collection is completed with coordinating custom rope handle totes.

IN STOCK Hinged Boxes

E-Commerce Jewelry Boxes

Deliver the 'in-store' experience to your customer's door
See page 101 for more information



COORDINATING EUROTOTE
See page 76



415B - Black Packer with Ivory Pouch
456P - Purple Packer with Ivory Pouch
427T - Bronze Packer with Ivory Pouch

Available Colors



873B - Bronze



563P - Purple



153B - Black



083 - Luxe Silver*

Geo

Modern texture in a choice of 4 color options.

- Ivory brushed leatherette pads and satin top liners
- Packaged in a coordinating ¾ depth 2-piece outer box

CODE	DESCRIPTION	SIZE (inches)
36221	Ring/Earring (R1/E8)	2.375 x 2.375 x 2.375
36283	T-pad Pendant (ET14)	3.5 x 4.5 x 1.5
36293	Bracelet (BL1)	9 x 2.375 x 1.5
36273	Necklace (N2)	7 x 7 x 1.5
36220	Proposal Box* (R2)	2.36 x 2.36 x .94
36224	Lighted Ring/Earring* (R1)	2.36 x 2.36 x 2.36
09030	Pouch with Box*	3 x 4
69221100G	Earring Pad to fit Ring/Earring box (E8)	

* not available in Luxe Silver

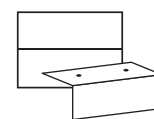

R1 / E8
2-PIECE EARRING /
SLOTTED RING PAD

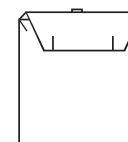

E8
LEVER BACK EARRING PAD



ET14
T FLAP PENDANT/EARRING PAD

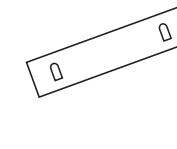

BL1
BRACELET PAD (metal clip)
GLUED PAD

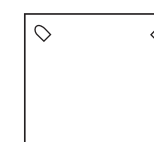

N2
NECKLACE PAD GLUED



R2
RING CLIP - PROPOSAL PAD



See page 50.



FOIL / PAD PRINT

F: inside liner and packer lid / PP: all 3 locations
12+ 32¢ each
144+ 29¢ each
504+ 24¢ each

Minimum 12 per style.
Please allow 2 - 3 weeks for printed items from approved art.

All print orders subject to set-up charges. Applicable artwork, and plate charges may apply. See page 122.

JEWELRY PACKAGING



50% Recycled Shell
and FSC Paper Used

SPECIAL ORDER

Geo Series Boxes and Bags

JEWELRY PACKAGING



Available in 16 colors
in a selection of 4 luxurious
textured papers.



Shown in Celestial Blue

Shown in Moss

Shown in Brick

Contact your representative for assistance
selecting your texture and color.

SPECIAL ORDER

Geo Series Boxes and Bags

JEWELRY PACKAGING

16 Color Options Available

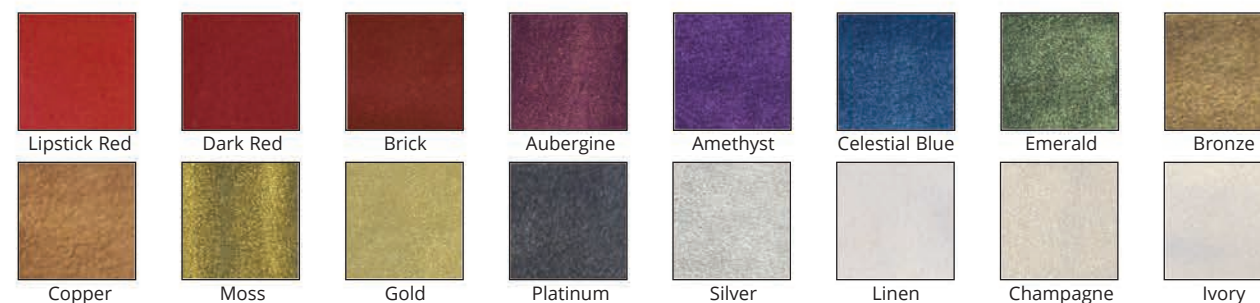

4 Texture Paper Options Available

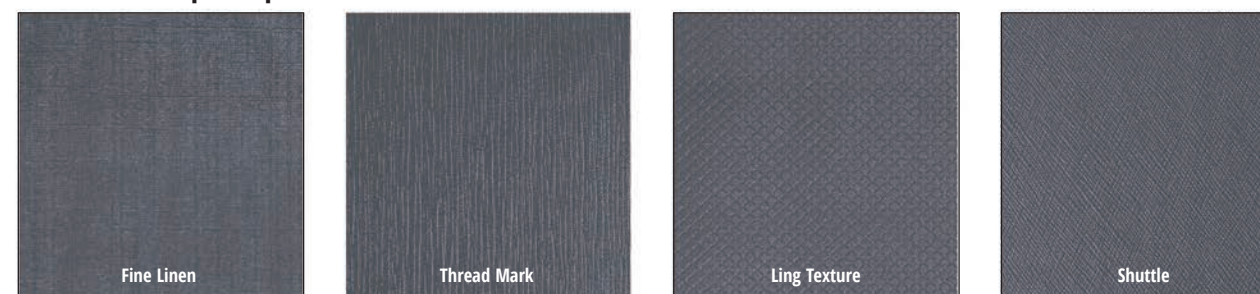

Geo Hinged Packaging

- Ivory brushed leatherette pads and satin top liners
- Packaged in a coordinating ¾ depth 2-piece outer box

DESCRIPTION	SIZE (inches)
Ring/Earring (R1/E8)	2.375 x 2.375 x 2.375
T-pad Pendant (ET14)	3.5 x 4.5 x 1.5
Bracelet (BL1)	9 x 2.375 x 1.5
Necklace (N2)	7 x 7 x 1.5
Proposal Box (R2)	2.36 x 2.36 x .94

 **FOIL PRINT** - INCLUDED IN PRICE
Inside Top Liner
Packer Lid

Boxes: Minimum 1500 assorted! (min 100 per box)
Bags: Minimum 1000 each size with purchase of 1500 boxes.
Estimated lead time: 12 - 14 weeks for printed items from approved art.

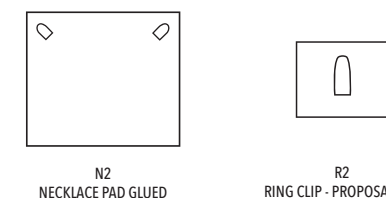
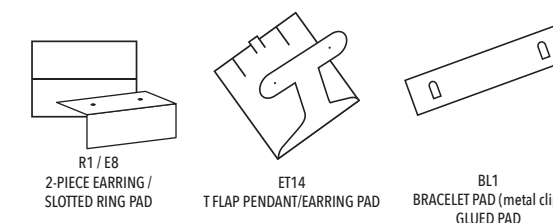

Geo Eurototes

- 110 gsm uncoated paper with 8mm rope handles
- Foil printed two sides

SIZE (inches)	MOQ
6 x 3.5 x 6 x 3.5	1000+ with boxes 3000+ no boxes
9 x 3.5 x 7 x 3.5	
10.5 x 5 x 8.5 x 5	

 **FOIL PRINT**
PRINTING INCLUDED IN PRICE

Bags Only: Minimum 3000 each size.
Estimated lead time: 12 - 14 weeks for printed items from approved art.

Our Top Selling Collection Just Got Even Better!

Printing included for
any of the items in this program.

Choice of Matte or Metallic Foil Print:
Gold, Silver, Copper or Black.

All print orders subject to set-up charges. Applicable artwork, and plate charges may apply. See page 122.

IN STOCK

Hinged Boxes

IN STOCK

Hinged Boxes

JEWELRY PACKAGING

JEWELRY PACKAGING



COORDINATING EUROTOTE
See page 77

COORDINATING ALL PAPER EUROTOTE
See page 79

Palladium Inlay

Stylish contemporary series.

- Palladium grey brushed exterior
- Cream pads and top liner with matching exterior edge
- Packaged in a coordinating 2-piece outer box

CODE	DESCRIPTION	SIZE (inches)
36221283P	Ring (R1)	2.25 x 2 x 1.75
36222283P	Earring (E1)	2.25 x 2 x 1.75
36283283P	Utility T-pad (ET14)	3.18 x 4.17 x 1.41
36293283P	Bracelet (BL1)	8.6 x 2.16 x 1
36273283P	Necklace (N2)	6.25 x 4.4 x 1.4



FOIL / PAD PRINT
F: inside liner and packer lid / PP: all 3 locations
12+ 32¢ each
144+ 29¢ each
504+ 24¢ each

Minimum 12 per style.
Please allow 2 - 3 weeks for printed items from approved art.



EcoBox

Modern look inside and out.

- Gunther Mele Mission Green product
- Made with recycled paper exterior
- Made with 50% recycled material plastic shell
- Resuede interior material (49% recycled)

CODE	DESCRIPTION	SIZE (inches)
36121000	Ring/Earring (R1)	2 x 2 x 1.5
36163000	T-Pad Pendant/Earring (ET14)	3.75 x 3.75 x 1.33
36193000	Bracelet (BL1)	8.5 x 2 x .91
36173000	Necklace (N3)	7 x 5 x 1.10

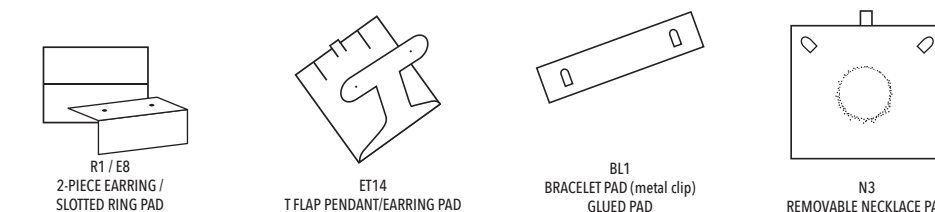

FOIL / PAD PRINT
F: inside liner / PP: top lid
12+ 32¢ each
144+ 29¢ each
504+ 24¢ each

Minimum 12 per style.
Please allow 2 - 3 weeks for printed items from approved art.



50% Recycled Shell

CREATE YOUR OWN LOOK

IN STOCK Hinged Boxes

JEWELRY PACKAGING

JEWELRY PACKAGING



VANTAGE SERIES

6 pieces – 2 boxes + 4 inserts + 9 presentations. A streamlined and customized assortment.



COORDINATING EUROTOTE
See below and on page 76

Ring box shown with optional earring pad in place

Available Colors

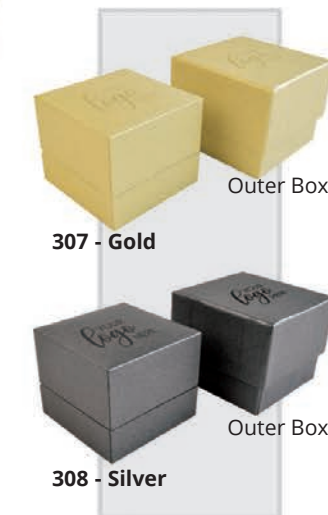

Outer Box

307 - Gold

Outer Box

308 - Silver

Vantage II

Elegant gold and silver in a linen embossed pattern.

- White satin top liners and leatherette bottom pads
- Packaged in a coordinating 3/4 depth lid 2-piece outer box



See page 50.

CODE	DESCRIPTION	SIZE (inches)
36221	Ring/Earring (R1/E8)	2 x 2 x 1.625
36232	T-Pad Pendant (ET14)	2.64 x 2.72 x 2.165
36284	Utility T-pad (ET14)	3.5 x 3.5 x 2
36293	Bracelet (BL1)	8.625 x 2.125 x 1.25
36273	Necklace (N2)	6.25 x 4.5 x 1.5

Minimum 12 per style. Please allow 2 - 3 weeks for printed items from approved art.

FOIL / PAD PRINT
F: inside liner and packer lid / PP: all 3 locations
12+ 32¢ each
144+ 29¢ each
504+ 24¢ each

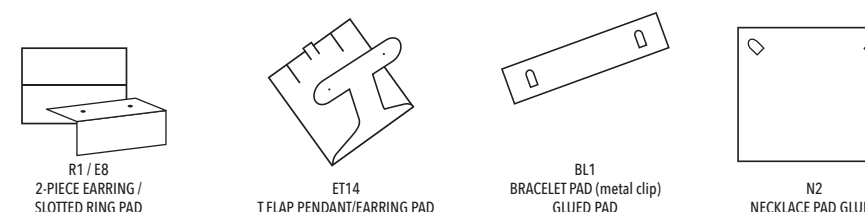

50% Recycled Shell and FSC Paper Used

Coordinating Eurototes

- 150 gsm uncoated paper with 8mm paper cord handles
- Minimum 100 per color

CODE	SIZE (inches)
230606	6 x 3.5 x 6 x 3.5
231008	10.5 x 5 x 8.5 x 5



07V - Gold

08V - Silver

Estimated lead time: 2 - 3 weeks for printed items from approved art.

FOIL PRINT
100+ 32¢ each
1000+ 29¢ each
2500+ 24¢ each

All print orders subject to set-up charges. Applicable artwork, and plate charges may apply. See page 122.

IN STOCK

Hinged Boxes

JEWELRY PACKAGING



COORDINATING EUROTOTE
See page 77



Glitter

Sparkle and shine with this great glittering series.

- White faux-suede pads and satin top liners
- Packaged in a black sleeve

CODE	DESCRIPTION	SIZE (inches)
36221183	Ring (R1)	1.75 x 2 x 1.5
36222183	Earring (E1)	1.75 x 2 x 1.5
36284183	Utility T-pad (ET14)	3.5 x 3.5 x 1.25
36293183	Bracelet (BL1)	8.75 x 2.125 x 1
36273183	Necklace (N2)	6.25 x 4.25 x 1.25



FOIL / PAD PRINT
F: inside liner / PP: inside top liner and box lid
12+ 32C each
144+ 29C each
504+ 24C each

Minimum 12 per style.
Please allow 2 - 3 weeks for printed items from approved art.



IN STOCK

Hinged Box

JEWELRY PACKAGING



Available Colors

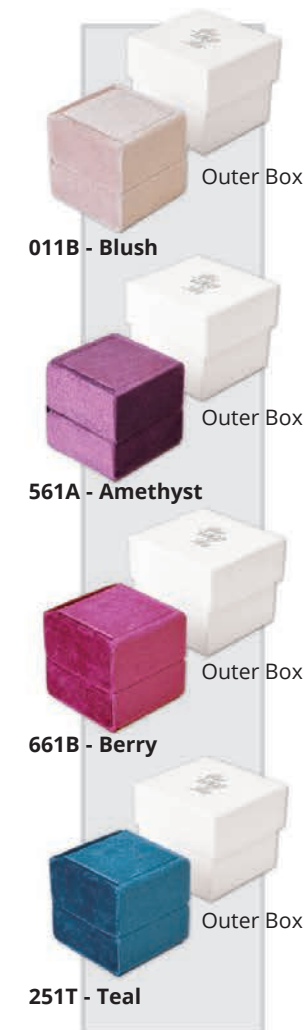

Sweetheart

Show the love with this sweet new velvet vintage inspired ring box.

- Velvet with satin top liner to put a small logo or icon
- Available in soft blush and three jewel tone colors
- Packaged in a 2-piece white outer box

CODE	DESCRIPTION	SIZE (inches)
36121 _ _ _	Ring (R1)	1.5 x 1.5 x 1.5

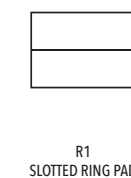

FOIL / PAD PRINT
F: inside liner and packer lid / PP: inside top liner and packer lid
12+ 32C each
144+ 29C each
504+ 24C each

Minimum 12 per style.
Please allow 2 - 3 weeks for printed items from approved art.



IN STOCK

Hinged Boxes

JEWELRY PACKAGING



COORDINATING EUROTOTE
See page 77

New Black Top Liners Available



Jewellers Velvet

Lasting traditions.

- Satin top liners in Black or White
- Packaged in a white 2-piece outer box

CODE	DESCRIPTION	SIZE (inches)
36121 ___	Ring (R1)	2 x 2.125 x 1.5
36141 ___	Large Ring (R2)	2.5 x 2 x 1.5
36122 ___	Earring (E2)	2 x 2.125 x 1.5
36132 ___	Utility T-pad (ET14)	2.5 x 2.5 x 1.25
36163 ___	Pendant (E1)	2.25 x 3 x 1.125
36183 ___	Utility (EP4)	3.5 x 3.375 x 1.5
36193 ___	Bracelet (BL1)	8 x 2 x 1.25
36173 ___	Necklace (N2)	7 x 4.25 x 1.5
69221000B	Bead Pad for earring box	



Bead Pad

- pad fits stud earring box
- ribbon threads through bead
- ribbon wraps to back and is held by clip

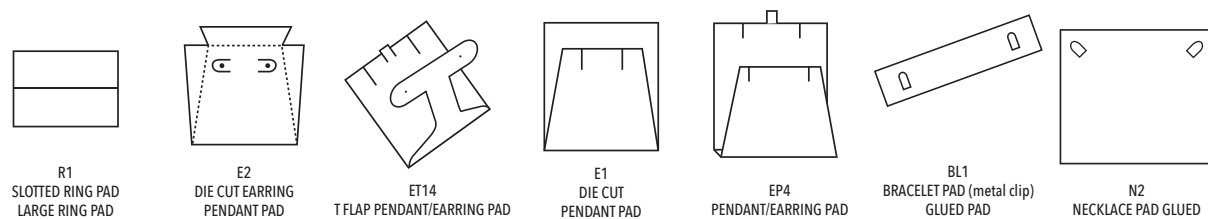

FOIL / PAD PRINT

F: inside liner and packer lid / PP: inside top liner and packer lid
12+ 32¢ each
144+ 29¢ each
504+ 24¢ each

Minimum 12 per style.
Please allow 2 - 3 weeks for printed items from approved art.



IN STOCK

Hinged Boxes

JEWELRY PACKAGING



COORDINATING EUROTOTE
See page 77

ADDITIONAL CHARGE FOR OPTIONAL 2-PIECE OUTER BOX



Econoline

Lasting traditions in blue.

- Blue velour exterior
- Matching interior with white satin
- Arrives in protective white sleeve
- Optional white gloss packer

CODE	DESCRIPTION	SIZE (inches)	2-PIECE CONTAINER PRICE / EACH 31 ___ 003
36121119	Ring (R1)	1.875 x 2.125 x 1.375	121
36141119	Large Ring (R1)	2.375 x 2 x 1.5	141
36122119	Earring (E2)	1.875 x 2.125 x 1.375	121
36163119	Pendant (E1)	2.25 x 3 x 1.125	163
36132119	T-pad Pendant (ET14)	2.5 x 2.5 x 1.25	132
36193119	Bracelet (BL1)	8 x 2.125 x 1	193
36173119	Necklace (N2)	7 x 4.25 x 1.375	173
36183119	Utility (EP4)	3.875 x 3.25 x 1.375	183
69221000B	Bead Pad for earring box		—



Bead Pad

- pad fits stud earring box
- ribbon threads through bead
- ribbon wraps to back and is held by clip

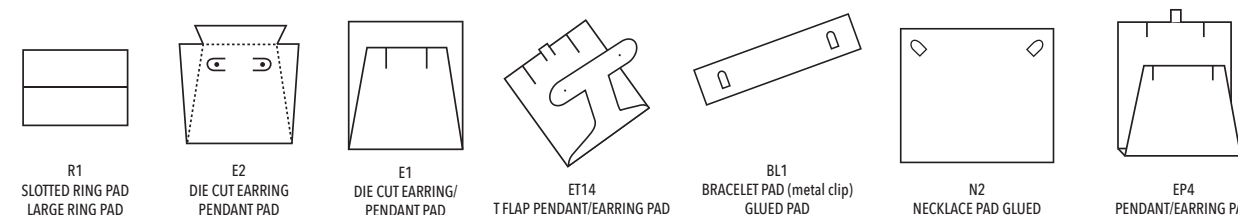

FOIL / PAD PRINT

F: inside liner and packer lid / PP: inside top liner and packer lid
12+ 32¢ each
144+ 29¢ each
504+ 24¢ each

Minimum 12 per style.
Please allow 2 - 3 weeks for printed items from approved art.



All print orders subject to set-up charges. Applicable artwork, and plate charges may apply. See page 122.

All print orders subject to set-up charges. Applicable artwork, and plate charges may apply. See page 122.

IN STOCK

Hinged Boxes

IN STOCK

Hinged Boxes



COORDINATING EUROTOTE
See page 77



Outer Box

Elan

Timeless classic in all white.

- Soft, white leatherette covering
- Coordinating leatherette pads and white satin top liners
- Packaged in a white traditional 2-piece outer box

CODE	DESCRIPTION	SIZE (inches)
36021002	Ring (R1)	2 x 2.25 x 1.625
36041002	Large Ring (R1)	3 x 2 x 1.5
36022002	Earring (E1)	2 x 2.25 x 1.5
36084002	Utility T-pad (ET14)	3.5 x 3.5 x 1.375
36093002	Bracelet (BL1)	8.625 x 2.25 x 1
36073002	Necklace (N2)	7.125 x 4.375 x 1.25



FOIL / PAD PRINT

F: inside liner and packer lid / PP: all 3 locations
 12+ 32¢ each
 144+ 29¢ each
 504+ 24¢ each

Minimum 12 per style.
 Please allow 2 - 3 weeks for printed items from approved art.



See page 50.



COORDINATING EUROTOTE
See page 77

Econolux

Style meets value.

- Soft, white leatherette covering
- White suedine pads and satin top liners
- Packaged in a white tuck outer box (2-piece traditional outer box available)

CODE	DESCRIPTION	SIZE (inches)	2-PIECE CONTAINER
			PRICE / EACH
			31 _ _ 003
36121002	Ring (R1)	1.875 x 2.125 x 1.375	121
36141002	Large Ring (R1)	2.375 x 2 x 1.5	141
36122002	Earring (E2)	1.875 x 2.125 x 1.375	121
36163002	Pendant (E1)	2.25 x 3 x 1.125	163
36132002	T-pad Pendant (ET14)	2.5 x 2.5 x 1.25	132
36193002	Bracelet (BL1)	8 x 2.125 x 1	193
36173002	Necklace (N2)	7 x 4.25 x 1.375	173
36183002	Utility (EP4)	3.875 x 3.25 x 1.375	183
69221000B	Bead Pad for earring box		—

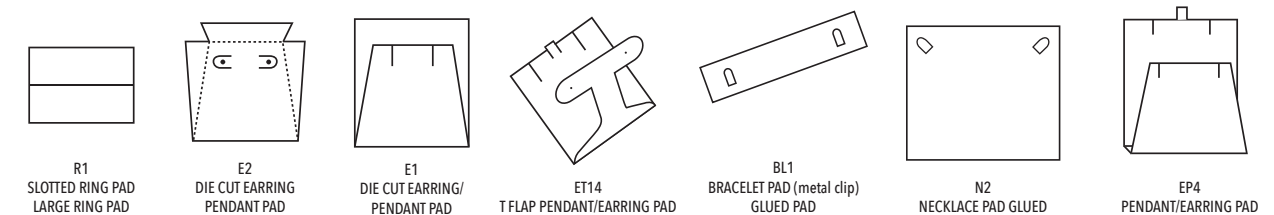

FOIL / PAD PRINT

F: inside liner and packer lid / PP: all 3 locations
 12+ 32¢ each
 144+ 29¢ each
 504+ 24¢ each

Minimum 12 per style.
 Please allow 2 - 3 weeks for printed items from approved art.



See page 50.

ADDITIONAL CHARGE FOR OPTIONAL 2-PIECE OUTER BOX



Outer Sleeve



Bead Pad

- pad fits stud earring box
- ribbon threads through bead
- ribbon wraps to back and is held by clip

IN STOCK

Hinged Boxes

Deliver the 'in-store' experience to your customer's door. See page 101 for more information

COORDINATING EUROTOTE
See page 77



Gold Galleria

A new gold standard.

- White velour pads and satin top liners
- Packaged in a white traditional 2-piece outer box

CODE	DESCRIPTION	SIZE (inches)
36621073	Ring (R1)	2.125 x 2 x 2
36622073	Earring (E1)	2.125 x 2 x 2
36641073	Large Ring (R1)	3 x 2 x 2
36684073	Utility T-pad (ET14)	3.5 x 3.5 x 1.5
36693073	Bracelet (BL1)	8.25 x 2.125 x 1.25
36673073	Necklace (N2)	6.25 x 5 x 1.5
36650073	Bangle (R1)	1.25 x 3.75 x 3.125
69621000B	Bead Pad for earring box	



E-Commerce Jewelry Boxes

Deliver the 'in-store' experience to your customer's door. See page 101 for more information

COORDINATING EUROTOTE
See page 77



Horizon

The gold standard in a classic white, burgundy and black.

- White velour pads and satin top liners
- Packaged in a white traditional 2-piece outer box

CODE	DESCRIPTION	SIZE (inches)
36621 ___	Ring (R1)	2.125 x 2 x 2
36622 ___	Earring (E1)	2.125 x 2 x 2
36641 ___	Large Ring (R1)	3 x 2 x 2
36684 ___	Utility T-pad (ET14)	3.5 x 3.5 x 1.5
36632 ___	T-Pad Pendant (ET14)	2.75 x 2.75 x 1.375
36693 ___	Bracelet (BL1)	8.25 x 2.125 x 1.25
36673 ___	Necklace (N2)	6.25 x 5 x 1.5
36650 ___	Bangle (R1)	1 x 3.75 x 3.125
69621000B	Bead Pad for earring box	

BLACK PADS AVAILABLE (3 SIZES)

36621153B	Single Ring Pad (black)	2.125 X 2	box w/pad
69622153B	Stud Earring Pad (black)	2.125 x 2	pad only
69633153B	Pend/Earring Pad (black)	2.75 x 2.75	pad only

Available Colors



003 - White
Outer Box

663 - Burgundy
Outer Box

153 - Black
Outer Box



Outer Box



Bead Pad

- pad fits stud earring box
- ribbon threads through bead
- ribbon wraps to back and is held by clip



Bead Pad

- pad fits stud earring box
- ribbon threads through bead
- ribbon wraps to back and is held by clip



FOIL / PAD PRINT

F: inside liner and packer lid / PP: all 3 locations
12+ 32¢ each
144+ 29¢ each
504+ 24¢ each

Minimum 12 per style.
Please allow 2 - 3 weeks for printed items from approved art.



See page 50.



FOIL / PAD PRINT

F: inside liner and packer lid / PP: all 3 locations
12+ 32¢ each
144+ 29¢ each
504+ 24¢ each

Minimum 12 per style.
Please allow 2 - 3 weeks for printed items from approved art.



See page 50.

All print orders subject to set-up charges. Applicable artwork, and plate charges may apply. See page 122.

All print orders subject to set-up charges. Applicable artwork, and plate charges may apply. See page 122.

IN STOCK

Jewelry Packaging



Available Colors



Nano Clutch

Perfect for gifting and on the go, this collection is going places!

- Linea envelope, and pad
- Packaged in a 2-piece matching outer box

CODE	DESCRIPTION	SIZE (inches)
09121	Ring (R1)	2.55 X 2.55
09163	Pendant (P3)	4 X 4
09193	Bracelet (BL1R)	9.625 X 3.125
09173	Necklace (N1)	6.625 X 6.625

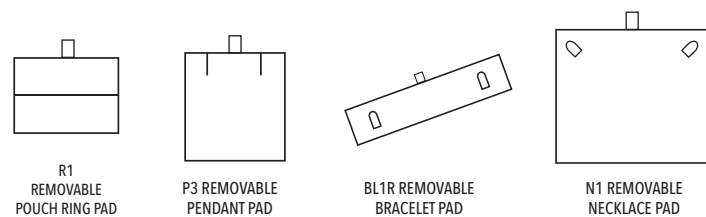

FOIL / PAD PRINT
 F: outside flap and packer / PP: outside flap and packer
 12+ 32¢ each
 144+ 29¢ each
 504+ 24¢ each

Minimum 12 per style.
 Please allow 2 - 3 weeks for printed items from approved art.



IN STOCK

Specialty



The Drawer Box

Eco-friendly, on trend series.



- Removable resuede recycled pads
- Fixed ring pad with foam
- Made with 100% recyclable Paper Board
- Coordinates with the Nano Pouch for a stunning reveal (earring & pendant)

CODE	DESCRIPTION	SIZE (inches)	CASE PACK
31050603	Ring (R1)	2.24 x 2.36 x 1.98	50
31070703	Earring Utility	2.75 x 2.83 x 1.57	50
31101003	Pendant Utility	3.93 x 4 x 1.57	50

Minimum one case pack.
 Please allow 2 - 3 weeks for printed items from approved art.

PAD PRINT
 PP: box top
 50+ 32¢ each
 500+ 29¢ each
 2500+ 24¢ each



Vision Box

Unique transparent 3D window box with coordinating display stand.

- Transparent puncture resistant elastic film
- Conforms to hold any jewelry piece
- Coordinating display base (extra)



CODE	DESCRIPTION	SIZE (inches)
36301103	Small	2.68 x 2.68 x .75
36302103	Medium	3.5 x 3.5 x .75
36303103	Large	4.25 x 4.25 x .75
69300103	Base (pkg of 12)	2.25 x 2.25 x .62

PAD PRINT
 PP: side of lid - text only - limited space
 12+ 32¢ each
 144+ 29¢ each
 504+ 24¢ each

Minimum 12 per style.
 Please allow 2 - 3 weeks for printed items from approved art.

All print orders subject to set-up charges. Applicable artwork, and plate charges may apply. See page 122.

All print orders subject to set-up charges. Applicable artwork, and plate charges may apply. See page 122.

CREATE
YOUR OWN LOOK

JEWELRY PACKAGING



PAPERBOARD SERIES

Stylized lines and the geometric pattern gives this collection an art deco feel.

IN STOCK
Paperboard Hinged

JEWELRY PACKAGING



**COORDINATING
EUROTOTE**
See page 79



Outer Sleeve



Pads are removable and reversible. Choose white flock or black flock.

Deco

Iconic black and white.

- Paperboard construction, covered in smooth laminate paper
- Flocked reversible black and white foam pads
- Packaged in individual white sleeves

CODE	DESCRIPTION	SIZE (inches)	CASE PACK
31621153D	Ring (R1H)	2 x 2 x 1	50
31622153D	Earring (P3)	2 x 2 x 1	50
31632153D	Large Earring (P3)	2.5 x 2.5 x 1.75	50
31684153D	Utility (P2)	3.75 x 3.75 x 1.5	50
31693153D	Bracelet (BL1)	9 x 2 x 1,125	50
31673153D	Necklace (N2)	6.5 x 8 x 2	50



Recycled Paperboard

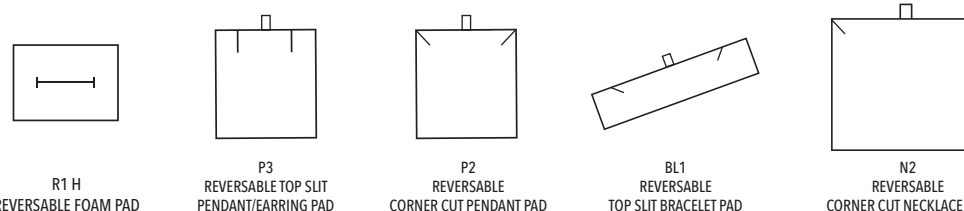

R1 H
REVERSABLE FOAM PAD

P3
REVERSABLE TOP SLIT
PENDANT/EARRING PAD

P2
REVERSABLE
CORNER CUT PENDANT PAD

BL1
REVERSABLE
TOP SLIT BRACELET PAD

N2
REVERSABLE
CORNER CUT NECKLACE PAD



FOIL / PAD PRINT
F: inside and top lid / PP: inside and top lid
50+ 32c each
500+ 29c each
2500+ 24c each

Minimum one case pack.
Please allow 2 - 3 weeks for printed items from approved art.

All print orders subject to set-up charges. Applicable artwork, and plate charges may apply. See page 122.

IN STOCK

2-Piece Boxes

COORDINATING EUROTOTE
See page 76



E-Commerce Jewelry Boxes

Deliver the 'in-store' experience to your customer's door



See page 101 for more information

Available Colors



273 - Bronze



153 - Black

Velocity

Organza ribbon and classic boxes make for perfect partners.

- Texture paper wrapped 2-piece boxes with white flocked foam pads
- Coordinating organza ribbon
- Match with Bronze Geo series and Geo Eurototes

CODE	DESCRIPTION	SIZE (inches)	CASE PACK
31221 ___	Ring (R1)	2.5 x 2.25 x 2	50
31283 ___	Utility (E1)	3 x 3 x 2	50
31293 ___	Bracelet (BL2)	9 x 2.25 x 1.5	25
31273 ___	Necklace (N1)	6.25 x 8 x 2	25

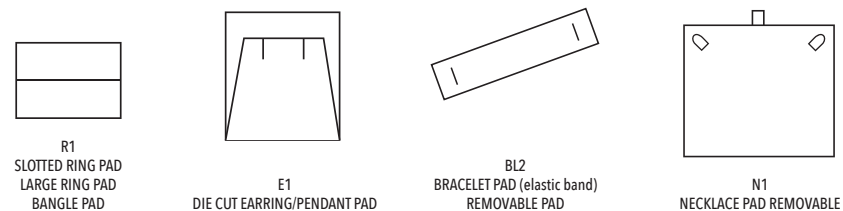

FOIL / PAD PRINT
F: inside and top lid / PP: inside and top lid
25/50+ 32c each
1000+ 29c each
2500+ 24c each

Minimum one case pack.
Please allow 2 - 3 weeks for printed items from approved art.



IN STOCK

2-Piece Boxes

NEW! COORDINATING ALL PAPER EUROTOTE
See page 79



Romance

Perfect partners in ivory and gold.

- Texture paper wrapped 2-piece boxes with white flocked foam pads
- Coordinating organza ribbon
- Match with Cream All Paper Eurototes

CODE	DESCRIPTION	SIZE (inches)	CASE PACK
31221863	Ring (R1)	2.5 x 2.25 x 2	100
31222863	Earring (E1)	2 x 1.5 x 1.187	100
31263863	Utility (P3)	3 x 3 x 2.125	100
31293863	Bracelet (BL1)	9 x 2.375 x 1.5	50
31273863	Necklace (N2)	6.375 x 8 x 2	50

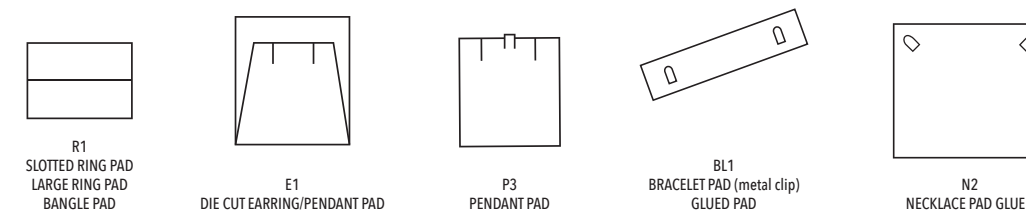

FOIL / PAD PRINT
F: inside and top lid / PP: inside and top lid
50/100+ 32c each
1000+ 29c each
2500+ 24c each

Minimum one case pack.
Please allow 2 - 3 weeks for printed items from approved art.



All print orders subject to set-up charges. Applicable artwork, and plate charges may apply. See page 122.

All print orders subject to set-up charges. Applicable artwork, and plate charges may apply. See page 122.

IN STOCK

2-Piece Boxes

JEWELRY PACKAGING



COORDINATING EUROTOTE
See pages 77

Shadow

Shimmery grey exterior, featuring a wave reveal.

- Texture paper wrapped 2-piece boxes with white flocked foam pads
- Match with Rope Handle Eurototes
- No packer/no sleeve

CODE	DESCRIPTION	SIZE (inches)	CASE PACK
31511308	Charm (C1)	2 x 2 x 1	100
31521308	Ring/Earring (R1H)	2 x 2 x 1.75	100
31563308	Pendant/Earring (P2)	3.5 x 3.5 x 1.25	50
31593308	Bracelet (BL2)	9 x 2 x 1	50
31573308	Necklace (N1)	6 x 6 x 1.5	50

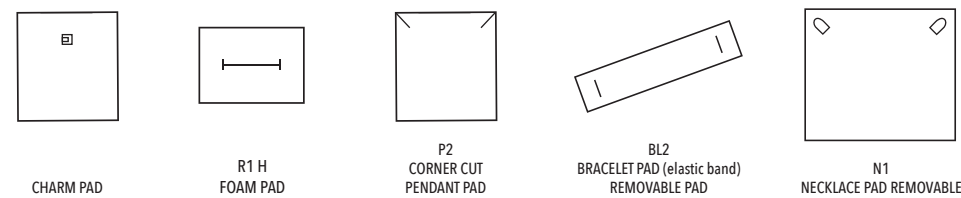

FOIL / PAD PRINT
F: inside and top lid / PP: inside and top lid
50/100+ 32c each
1000+ 29c each
2500+ 24c each

Minimum one case pack.
Please allow 2 - 3 weeks for printed items from approved art.



IN STOCK

Paperboard Hinged

JEWELRY PACKAGING



COORDINATING EUROTOTE
See pages 77

Royale

Hinged, white paperboard boxes covered in finely ribbed paper with gold accent lines.

- Texture paper wrapped hinged boxes with white flocked foam pads
- Match with Rope Handle Eurototes
- Packaged in individual white sleeves

CODE	DESCRIPTION	SIZE (inches)	CASE PACK
31545003	Ring/Earring (R1H)	2.5 x 2 x 1.5	100
31533003	Pendant/Earring (P2)	2.75 x 2.75 x 1	100
31560003	Utility (P3)	3.5 x 3.5 x 1	50
31580003	Bracelet (BL2)	8.125 x 2.125 x 1	50
31575003	Necklace (N1)	6.5 x 4.5 x 1	50

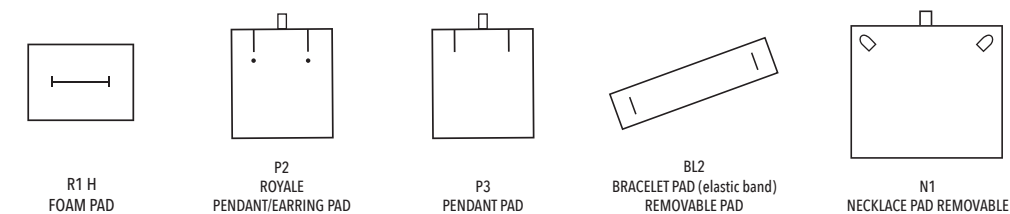

FOIL / PAD PRINT
F: inside and top lid / PP: inside and top lid
50/100+ 32c each
1000+ 29c each
2500+ 24c each

Minimum one case pack.
Please allow 2 - 3 weeks for printed items from approved art.



All print orders subject to set-up charges. Applicable artwork, and plate charges may apply. See page 122.

All print orders subject to set-up charges. Applicable artwork, and plate charges may apply. See page 122.

SPECIAL ORDER

Nest Boxes



100% Recycled Board

Available Colors



849 - Red

192 - Solid White



231 - Black

138 - White



916 - Aqua

Berkeley

Simple yet striking keyline design collection.

- Gloss paper
- Fully customizable
- White flocked platform inserts

CODE	SIZE (inches)	CASE PACK
32201 ___	3 x 3 x 1.25	100
32202 ___	3.5 x 3.5 x 2	100
32203 ___	5 x 5 x 1.5	100
32204 ___	9 x 4.5 x 2	100

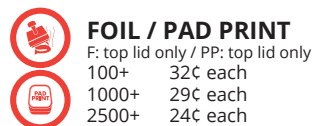

FOIL / PAD PRINT
 F: top lid only / PP: top lid only
 100+ 32¢ each
 1000+ 29¢ each
 2500+ 24¢ each

Minimum one case pack.
 Estimated lead time - Please allow 3 weeks for unprinted items and 4 weeks for printed items from approved art.

SPECIAL ORDER

Nest Boxes



100% Recycled Board



Cotton Filled Nest Boxes

Mix & Match!

Available Colors



CODE	SIZE (inches)	CASE PACK	061 French Floral	00K White Kromel	007 Gold Linen	008 Silver Linen	009 Brick Red	029 Cherry Red	354 Fuchsia	353 Blue Ice	045 Black Onyx/White Camas	155 Black Swirl	15P Black Pinstripe	055 Black Onyx	093 Slate Grey
31011 ___	1.75 x 1.125 x .625	100	✓	✓	✓	✓	-	-	-	-	-	✓	✓	-	-
31021 ___	2.5 x 1.5 x .875	100	✓	✓	✓	✓	✓	✓	✓	✓	✓	✓	✓	✓	✓
31032 ___	3 x 2.125 X 1	100	✓	✓	✓	✓	✓	✓	✓	✓	✓	✓	✓	✓	✓
31033 ___	3.5 x 3.5 x 1	100	✓	✓	✓	✓	✓	✓	✓	✓	✓	✓	✓	✓	✓
31036 ___	3.5 x 3.5 x 1.5	100	-	✓	✓	✓	-	-	-	-	-	✓	✓	✓	-
31034 ___	3.5 x 3.5 x 2	100	✓	✓	✓	✓	✓	✓	✓	✓	✓	✓	✓	✓	✓
31053 ___	5.25 x 3.75 x .875	100	✓	✓	✓	✓	✓	✓	✓	✓	✓	✓	✓	✓	✓
31065 ___	6 x 5 x 1	50	-	✓	✓	✓	✓	✓	✓	-	✓	✓	✓	✓	✓
31082 ___	8 x 2 x .875	100	-	✓	✓	✓	✓	-	✓	-	-	✓	✓	✓	✓
31085 ___	8 x 5.5 x 1.25	50	✓	✓	✓	-	-	-	-	-	-	-	✓	-	-

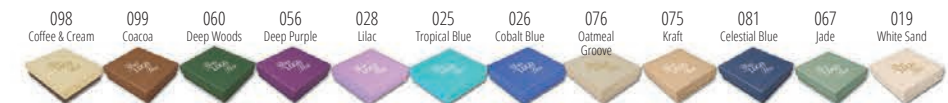

CODE	SIZE (inches)	CASE PACK	098 Coffee & Cream	099 Coacoa	060 Deep Woods	056 Deep Purple	028 Lilac	025 Tropical Blue	026 Cobalt Blue	076 Oatmeal Groove	075 Kraft	081 Celestial Blue	067 Jade	019 White Sand
31011 ___	1.75 x 1.125 x .625	100	-	-	✓	-	-	-	-	✓	✓	-	-	-
31021 ___	2.5 x 1.5 x .875	100	✓	✓	✓	✓	✓	✓	✓	✓	✓	✓	✓	✓
31032 ___	3 x 2.125 X 1	100	✓	✓	✓	✓	✓	✓	✓	✓	✓	✓	✓	✓
31033 ___	3.5 x 3.5 x 1	100	✓	✓	✓	✓	✓	✓	✓	✓	✓	✓	✓	✓
31036 ___	3.5 x 3.5 x 1.5	100	-	-	-	✓	-	-	-	✓	✓	-	-	-
31034 ___	3.5 x 3.5 x 2	100	✓	✓	✓	✓	✓	✓	✓	✓	✓	✓	✓	✓
31053 ___	5.25 x 3.75 x .875	100	✓	✓	✓	✓	✓	✓	✓	✓	✓	✓	✓	✓
31065 ___	6 x 5 x 1	50	✓	✓	✓	✓	-	✓	✓	✓	✓	✓	-	-
31082 ___	8 x 2 x .875	100	-	✓	✓	✓	-	-	-	✓	✓	-	-	-
31085 ___	8 x 5.5 x 1.25	50	-	-	✓	-	-	-	-	✓	✓	-	-	-



FOIL / PAD PRINT
 F: top lid only / PP: top lid only
 50/100+ 32¢ each
 1000+ 29¢ each
 2500+ 24¢ each

Minimum one case pack.
 Estimated lead time - Please allow 3 weeks for unprinted items and 4 weeks for printed items from approved art.

IN STOCK

Nest Boxes



These boxes match our **Damask Paper Shoppers** - page 85 and **Damask Pouches** - page 54

Damask

Style and substance in a simple packaging combination.

- Black and white 2-piece box
- 100% recycled board box
- Cotton fill pad wrapped with damask patterned tissue
- See our matching bag and pouch to complete your collection

CODE	DESCRIPTION	SIZE (inches)	CASE PACK
31570153D	Earring	3 x 2.125 x 1	100
31555153D	Brooch	3.5 x 3.5 x 1	100
31564153D	Bracelet	8 x 2 x .875	100
31558153D	Necklace	6 x 5 x 1	100

Minimum order is one case pack.

White Swirl Pattern



100% Recycled Board



FOIL / PAD PRINT
F: top lid only / PP: top lid only
100+ 32¢ each
1000+ 29¢ each
2500+ 24¢ each

Estimated lead time: 2 - 3 weeks for printed items from approved art.

White Economy

Sometimes a simple box is all you need!

- Made with 100% recycled board covered with white swirl paper
- Cotton filled to hold jewelry in place

CODE	DESCRIPTION	SIZE (inches)	CASE PACK
31502103	Charm	2.5 x 1.5 x .875	100
31570103	Earring	3 x 2.125 x 1	100
31555103	Brooch	3.5 x 3.5 x 1	100
31564103	Bracelet	8 x 2 x .875	100
31558103	Necklace	6 x 5 x 1	50
31576103	Large Necklace	8 x 5.5 x 1.25	50
31259103	Stand-Up Bangle	3.5 x 2 x 2 x 2	100

Minimum order is one case pack.



100% Recycled Board



FOIL / PAD PRINT
F: top lid only / PP: top lid only
50/100+ 32¢ each
1000+ 29¢ each
2500+ 24¢ each

Estimated lead time: 2 - 3 weeks for printed items from approved art.

IN STOCK

Jewelry Folders

15PB - Black

00PW - White



Passport Jewelry Folders

Designed with stylish envelope closure, snaps tight to keep jewels secure.

- Linea exteriors, satin interior
- Packaged in a 2-Piece white outer box
- Two colors soft white and black
- Case pack of 12

CODE	DESCRIPTION	SIZE (inches)
367950_----	Bracelet	8.25 x 1.75
367900_----	Necklace/Pearl	6 x 8



FOIL / PAD PRINT

Bracelet: F and PP: inside bottom flap and packer lid
Necklace: PP: top flap / F and PP: inside flap and packer lid
12+ 32¢ each
144+ 29¢ each
504+ 24¢ each

Estimated lead time: 2 - 3 weeks for printed items from approved art.

159W - Black
NO OUTSIDE PRINT

879B - Bronze



009P - Pearl

Global Jewelry Folders

Wide gusset folder for larger pieces.

- Bronze and pearl linea
- Black faux suede
- Satin interior and magnetic closure
- Packaged in a 2-Piece matching outer box
- Case pack of 12

CODE	SIZE (inches)
36790_----	5.5 x 7.5



FOIL / PAD PRINT

PP: top flap / F and PP: inside flap and packer lid
12+ 32¢ each
144+ 29¢ each
504+ 24¢ each

Estimated lead time: 2 - 3 weeks for printed items from approved art.

Hoop Earring Folder

Black ultrasuede folder with top stitch finish and black interior. Holds hoop earrings up to 2.75" in diameter.

- Packaged in a white 2-Piece outer box
- Case pack of 12

CODE	SIZE (inches)
36791015	4.5 x 4.5



FOIL / PAD PRINT

F: lower outside flap only and packer lid / PP: packer lid
12+ 32¢ each
144+ 29¢ each
504+ 24¢ each

Estimated lead time: 2 - 3 weeks for printed items from approved art.



Outer Box

Printable exterior

All print orders subject to set-up charges. Applicable artwork, and plate charges may apply. See page 122.

All print orders subject to set-up charges. Applicable artwork, and plate charges may apply. See page 122.

CREATE YOUR OWN LOOK

TELL YOUR BRAND STORY CREATE YOUR UNIQUE IDENTITY



Create Your Own Look in 7 Easy Steps

Speak to your sales representative for a consultation.

Looking for 100% custom design? Design your very own jewelry packaging.

STEP 1:

Choose your box style. We have access to endless design and looks. You dream it, we can create it. Choose from wood, plastic, MDF and paperboard shells. Select hinged or 2-piece. MOQ: Plastic or Metal 2,500 Wood 1,000 Paperboard 5,000

STEP 2:

Choose your covering and color. Leatherette, velvet, paper. Design your texture—hundreds to choose from, or create your own. Brushed leatherette, embossed papers, smooth, textured, Select from our color books, or use Pantone to specify your exact colors.

STEP 3:

Specify the interior. Select pad color and material for inside lid. Leatherette, brushed leatherette, flocked, velvet, velour. Decide on the top interior material—leatherette, brushed leatherette, satin, flocked, velvet. Select color—white, black, ivory are most common. Option—create a reveal with contrasting color.

STEP 4:

Design your packer. 2-piece box or sleeve. Often you can use the same material or create a coordinating color. Option -- add die cuts at bottom for ribbon, and/or reveal for contrasting color.



STEP 5:

Design logo placement. Areas to consider: Inside box lid (Top Satin) Packer Lid (can be centered, or placed at lower corner if using ribbon) Top Lid



STEP 6:

Select your pad designs. (See page 51)

STEP 7:

Email your artwork. Artwork ultimately needs to be in Vector file format. Your graphic designers should be able to assist you. Gunther Mele is also available to provide artwork assistance and full service design, cost is \$75/hour, min half hour charge.

CYOL has 16-20 weeks lead time. (Time frames based on signed approved artwork, quote and deposit). Printing and pre-production samples included at no extra charge.

Please note:

Logos with intricate lines and details (such as diamonds), often will not translate in small print areas, such as top satins. Designs with text and simple outlines work best for inside of ring boxes, etc. Reps and our designers will advise you when artwork should be modified to produce best results.

To ensure accuracy and best quality, signatures are required on all artwork documents and quote documents where noted. Production will not commence until all artwork, quotes and deposits are finalized and signed off. Your rep is available to work with you to ensure all documentation is completed to prevent delays. Please ensure your email access is update date.

Complete your look!

Bags, Tissue, Pouches, Ribbon, Displays, Necklace folders, and more!

Select from our in stock or create your own. Gunther Mele is your one stop for all your needs.

Our sales representative can help you design all your packaging and displays to tell your unique brand story.

CREATE YOUR OWN LOOK

RING PADS

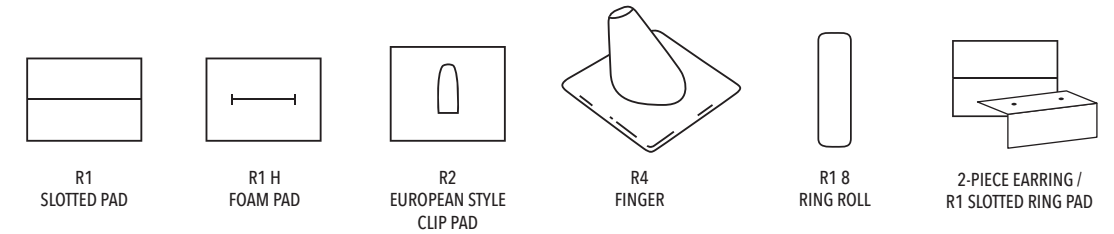

EARRING PADS

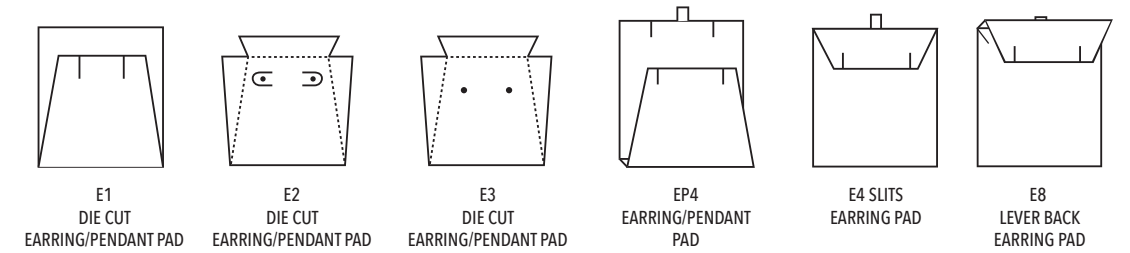

EARRING/PENDANT PADS

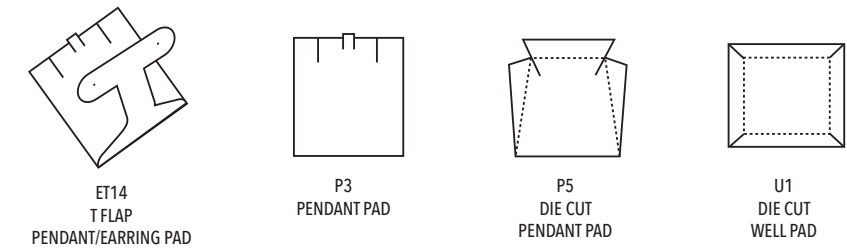

BRACELET AND WATCH PADS

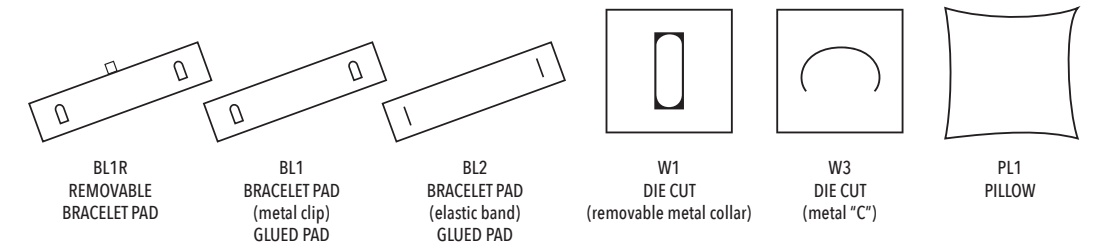

NECKLACE PADS

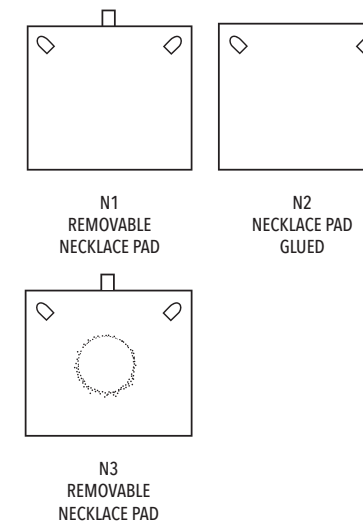

TRIPLE FLIP PADS

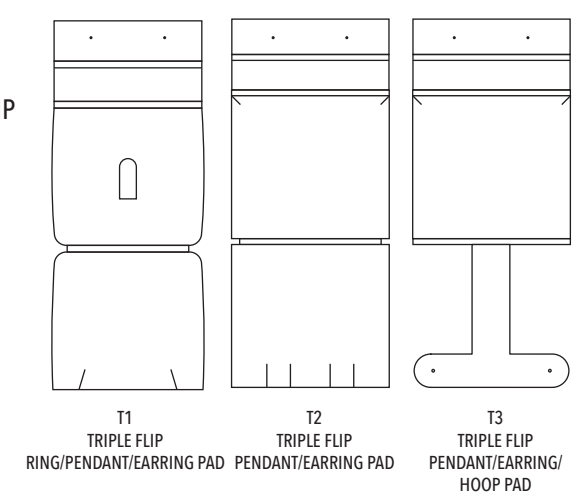

IN STOCK

Gift Card Boxes



Gift Cards
Not Included.

Black Gift Card Box with Ribbon

Estimated lead time: 2 - 3 weeks for printed items from approved art.
Minimum order is one case pack.

CODE	SIZE (inches)	CASE PACK
31040315	4 x 3 x .625	100

FOIL / PAD PRINT	
F and PP: inside and top lid	
100+	32¢ each
1000+	29¢ each
2500+	24¢ each

Pewter Gift Card Box with Ribbon

Estimated lead time: 2 - 3 weeks for printed items from approved art.
Minimum order is one case pack.

CODE	SIZE (inches)	CASE PACK
31040742	7.5 x 4.25 x .625	50

FOIL / PAD PRINT	
F and PP: inside and top lid	
50+	32¢ each
1000+	29¢ each
2500+	24¢ each

Gift Certificate and Box

Estimated lead time: 2 - 3 weeks for printed items from approved art.

CODE	SIZE (inches)	CASE PACK
09221002B	White Gift Certificate Box Only	100
18197	English Gift Certificate 6.375 x 3.125" folded	100
18196	French Gift Certificate 6.375 x 3.125" folded	100

FOIL / PAD PRINT	
F and PP: certificate and top lid	
100+	32¢ each
1000+	29¢ each
2500+	24¢ each

Gift certificates are pre-numbered.

Minimum order is one case pack.



Sold separately.



SPECIAL ORDER

Gift Card Boxes



15 - Black

Gift Cards
Not Included.

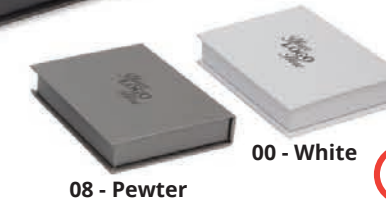

08 - Pewter

00 - White

Monte Carlo Gift Card Box

People love gift cards, this box takes the presentation to a new level.

- Smooth paper hinged box with magnetic closure
- Removable insert to hold card, just slide in place for secure hold
- Try 15-black with our clear black gloss print GL2

CODE	SIZE (inches)	CASE PACK
310239 __	5.125 x 4 x 1	100

FOIL / PAD PRINT	
F: inside lid only / PP: inside and outside lid	
100+	32¢ each
1000+	29¢ each
2500+	24¢ each

Estimated lead time: 3 weeks for unprinted items and 4 weeks for printed items from approved art.



00 - White

08 - Silver

73 - Gold

Gift Card Nest Box

- White paperboard platforms
- Interior has same paper for lids and bases

CODE	SIZE (inches)	CASE PACK
313230 __	3.5 x 2.25 x .75	100

Estimated lead time: 3 weeks for unprinted items and 4 weeks for printed items from approved art.



Gift Certificate Box

CODE	SIZE (inches)	CASE PACK
0922100_B	Gift Certificate Box Only see color options 6.625 x 3.25 x .5	100

Gift Certificate Box Color:



Minimum order is one case pack.

FOIL / PAD PRINT	
F and PP: top lid only	
100+	32¢ each
1000+	29¢ each
2500+	24¢ each

IN STOCK Finishing Touches

Available to finish the look of your gift certificate/card.

Stretch Loops (100 pack min.)

- 09500607 6" - Gold
- 09500608 6" - Silver
- 09501007 10" - Gold
- 09501008 10" - Silver



Dress it up with printed ribbon!
See page 114.



IN STOCK

Pouches

Microfiber Pouches

• Minimum case pack 100

CODE	COLOR	SIZE (inches)	CASE PACK
09040315	Black	4 x 3	100
09050415	Black	5-1/2 x 4	100
09040311	Blue	4 x 3	100
09050411	Blue	5-1/2 x 4	100



Damask Pouches



Zippered section

Envelope Pouches with snap closure



Available in black. Packaged in a 2-piece, pearlized, dark grey outer box.



Microfiber Bell Pouches +

• Minimum case pack of 12



White Leatherette Pouches



Gold Metallic Pouches



• Minimum case pack of 100

Velveteen Pouches



Black - 615
Royal Blue - 611
Brown - 612
Green - 667
Burgundy - 666

**See chart for 2-piece SPECIAL ORDER outer box for the Velveteen pouches.



Wedding Pouches +

White satin pouch with a white 2-piece outer box.

• Minimum case pack 12



CODE	TYPE	SIZE (inches)	CASE PACK
A 09040515D	Large Damask Pouch	5.5 x 4	100
B 09030315D	Small Damask Pouch	3 x 3	100
C 09304715	Large Envelope Pouch	3 x 4	100
D 09203715	Small Envelope Pouch	2.375 x 2.75	100
E 09525115B	Large Microfiber Bell Pouch	4.375 x 5.375	12
F 09324115B	Small Microfiber Bell Pouch	3.25 x 4.5	12
G 09314700	Large White Leatherette Pouch	3 x 4	100
H 09203700	Small White Leatherette Pouch	2.75 x 3.25	100
I 09314807	Gold Metallic Pouch	3 x 4	100
J 09405 ___	*Velveteen Pouches	4 x 5.5	100
K 09314 ___	*Velveteen Pouches	3 x 4	100
31314003	White 2-piece outer box**	3.25 x 4.25	100
3106500K	White 2-piece outer box	6 x 5 x 1	50
L 37501006	White Wedding Pouches	1.875 x 2.5	12

* See photo for color code

Economical packaging for inexpensive items or repairs.

Estimated lead time: 2 - 3 weeks for printed items from approved art.



FOIL / PAD PRINT

100+ 32¢ each
1000+ 29¢ each
2500+ 24¢ each



+ Bell Pouches and Wedding Pouch minimums:



FOIL / PAD PRINT

12+ 32¢ each
144+ 29¢ each
504+ 24¢ each



All print orders subject to set-up charges. Applicable artwork, and plate charges may apply. See page 122.

IN STOCK

Pouches

Geo Series

• Minimum case pack 12.

Estimated lead time: 2 - 3 weeks for printed items from approved art.



FOIL / PAD PRINT

F and PP: pouch and packer lid
12+ 32¢ each
144+ 29¢ each
504+ 24¢ each



CODE	TYPE	SIZE (inches)
A 09030415B	Geo Pouch with Black Box	3 x 4
B 09030456P	Geo Pouch with Purple Box	3 x 4
C 09030427T	Geo Pouch with Bronze Box	3 x 4

SPECIAL ORDER

Natural Jute and Natural Cotton Pouches

• Minimum 100 per size.

Estimated lead time: 6 weeks for printed items from approved art.



FOIL PRINT

100+ 32¢ each
1000+ 29¢ each
2500+ 24¢ each

Natural Cotton - FOIL PRINT ONLY

CODE	SIZE (inches)
09030400NC	3 x 4
09050600NC	5 x 6
09061000NC	6 x 10
09081200NC	8 x 12

Natural Jute - NO PRINT

CODE	SIZE (inches)
09050500NJ	3 x 5 1/2
09050600NJ	5 x 6
09061000NJ	6 x 10

Organza Colors (Not exactly as shown.)

Black - 030	Silver - 012	White - 029
Hunter - 589	Navy - 370	Smoke Blue - 337
Lt. Blue - 305	Burgundy - 276	Ultra Violet - 467
Purple - 465	Lavender - 430	Copper - 073
Orange - 750	Olive - 563	Mint - 530
Red - 250	Pink - 115	Gold - 690
Baby Maize - 617	Ivory - 810	Mauve - 161
Pastel Green - 513	Fruit Punch - 155	Yellow - 645
Turquoise - 340	Royal - 350	Fuchsia - 187

A is only available in Silver, White, Pink, Lavender, Gold and Ivory.

F not available in Fruit Punch, Orange, Royal, Turquoise and Yellow.

G is only available in Silver, White, Pink, Red, Burgundy, Lt. Blue, Royal, Lavender, Mint, Olive, Gold and Ivory.

CODE	SIZE (inches)
A 09905 ___	2 x 2.5
B 09910 ___	3 x 4
C 09915 ___	4 x 5.5
D 09920 ___	5 x 6.5
E 09925 ___	5.5 x 9
F 09930 ___	6 x 14
G 09950 ___	22 x 25 (not shown)

Minimum 100 per size/color.

Estimated lead time: 6 weeks for printed items from approved art. Foil printed to be determined.



FOIL PRINT - TBD

100+ 32¢ each
1000+ 29¢ each
2500+ 24¢ each



All print orders subject to set-up charges. Applicable artwork, and plate charges may apply. See page 122.

IN STOCK

Jewelry Care

Available for immediate shipment.

New



We care about your jewelry as much as you do!

We care about your jewelry, that's why we use better ingredients, better packaging, and you get better performance to keep you sparkling brighter all day long. Use Lavish everyday to safely and conveniently make your jewelry sparkle and shine more than it ever has.



Lavish Jewelry Bath

Jewelry bath includes 1 pod of our jewelry cleaner concentrate. An effective jewelry cleaner that can be used on all jewelry from Pearls and Opals to Diamonds without the risk of damage.

8 fl. oz. (236 ml)
04530000
50 per case pack



Lavish Polishing Cloth

Gold, Silver, Platinum oh my!

Bring back the shine of all your metals with the Lavish signature polishing cloth. Our polishing cloth is infused with a gentle and effective polishing compound that will bring back the luster and shine to your jewelry. Great for use on gold, silver, platinum, and other precious metals.

Note: To avoid the possibility of small scratches, care should be taken to avoid contact with stones other than diamonds. 8 fl. oz. (236 ml)

6" x 4" - Slate Grey with Vellum Envelope
04540000
50 per case pack



Handling Gloves

White microfiber. One size fits all. The natural oils in our skin can often leave displeasing marks on jewelry. Our microfiber, lint-free gloves are ideal for handling and protecting your most precious inventory.

05000296
Minimum order - 6 pairs



Lavish Foam

Our Lavish Jewelry Cleaning Foam is our #1 customer favorite product. The foam is a special blend of bio-based surfactants that coalesce in a foam to efficiently break down the daily buildup of grime and allow it to be easily rinsed away leaving nothing but sparkle and shine. The foam is dispensed through a non-aerosol pump foamer, so there are no nasty propellants to damage our ozone layer.

1.69 fl. oz. (50 ml) 04510050
2.5 fl. oz. (75 ml) 04510075

48 per case pack per size



Lavish Click Clean Pen

The Lavish Click Clean Pen is the ultra portable, ultra quick way to put the bling back in your ring. The non-toxic formulation is safe for all your jewelry and is ready to go whenever, wherever you are. The one-handed click action gives you control so you can dispense just the right amount of cleaning solution onto your jewelry. The soft brush tip makes it easy to get into hard to reach areas of your jewelry and underneath stones.

.108 fl. oz. (3.2 ml)
04520000
50 per case pack

SPECIAL ORDER

Jewelry Care

Estimated lead time: 3-4 weeks for printed items from approved art.

New



Customize with your store brand!

Quality professional jewelry care, such as LAVISH, starts as an add-on sale or complimentary gift with purchase and keeps customers coming back for more. Every time customers clean their jewelry with customized LAVISH jewelry care, they will think of your store.

Full Color Digital Printed Labels

Create your own full color look or our artist can create a design for your approval. Estimated lead time: 3 - 4 weeks for custom printed items from approved art.



Lavish Jewelry Bath

8 fl. oz. (236 ml)
04530000C
Minimum order 150 jars



Lavish Foam

1.69 fl. oz. (50 ml) 04510050C
2.5 fl. oz. (75 ml) 04510075C
Minimum order 96 bottles per size



Lavish Click Clean Pen

.108 fl. oz. (3.2 ml)
04520000C
Minimum order 100 pens



Lavish Polishing Cloth

6" x 4" - Slate Grey with Vellum Envelope
04540000C

Screen print colors: Silver, Gold or White (other colors available, please enquire)

Minimum order 200 cloths



Non-Toxic
User and Eco Friendly. Lavish is a bio-based cleaning formula that contains no harsh chemicals, peroxides, phosphates, or ammonia.



Made in the USA
Lavish was developed and is made by a 2nd generation jeweler/jeweler's whose ambition is to provide you with the safest, and most effective product available.



Biodegradable
Lavish is biodegradable. It breaks down rapidly and completely, meaning it will not contaminate or pollute our water, or our environment.



Safe
Lavish is safe for you, your jewelry, and our planet. From treating jewelry to your bathroom places, Lavish will bring back the sparkle and shine without the worry.



Diamond & Gem Cloths

Microfiber Cloth removes small dust, oily film, fingerprints and other residue from fine jewelry. Chemical Free. Lint Free. AVAILABLE IN LIGHT BLUE ONLY. Estimated lead time: 4 - 6 weeks for custom printed cloths from approved art.

8 x 8" Blue Cloth 04780800C
Minimum order is 144 cloths.

All print orders subject to set-up charges. Applicable artwork, and plate charges may apply. See page 122.

All print orders subject to set-up charges. Applicable artwork, and plate charges may apply. See page 122.

IN STOCK

Jewelry Care

Estimated lead time: 2 - 3 weeks for printed items from approved art.

Repair Envelopes

 **NO PLATE CHARGES!**

CODE	DESCRIPTION	SIZE (inches)
A 09850000	2-Part NCR	4.25 x 9
B 09845200	Plain-no perf., text or numbers	3.5 x 6.125
C 09845300	Double Perforated	3.5 x 6.125
D 09845400	Single Perforated	3.5 x 6.125
E 0985000E	2-part NCR - NO PRINT	4.25 x 9

• Prices include one color printing. A second color is \$ 0.029/each. Minimum 1000 per style. Printing colors: Black, Red, Green and Blue



Please allow 2 - 3 weeks for printing. \$34 set-up charge applies.

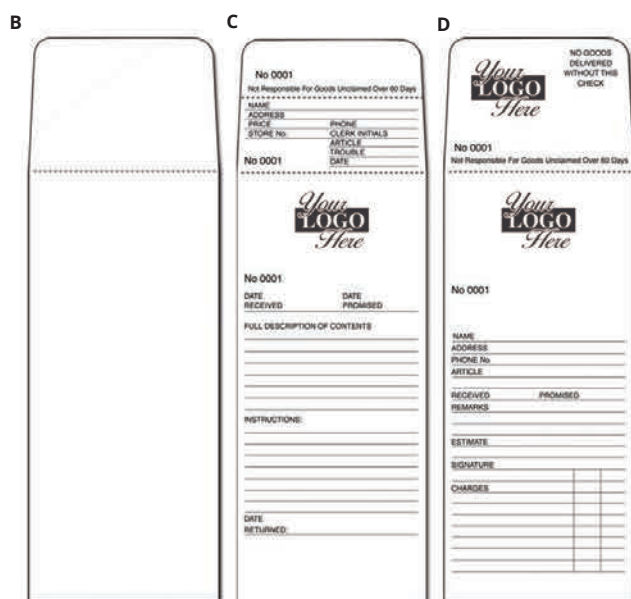

Tags and Miscellaneous Accessories

CODE	DESCRIPTION	PACK MIN.
E 08270207	Plastic Ring Tags - Gold	Box/1000
F 08270208	Plastic Ring Tags - Silver	Box/1000
G 08090707	Plastic With String Tags - Gold	Box/1000
H 08090708	Plastic With String Tags - Silver	Box/1000
I 08810800	Super Mylar Ring Tags - Wide	Box/1000
J 08810700	Super Mylar Ring tags - Narrow	Box/1000
08833000	Fine Pen Marker (not shown)	1



Available for immediate shipping for above items.

All print orders subject to set-up charges. Applicable artwork, and plate charges may apply. See page 122.

JEWELRY DISPLAY



CREATE YOUR OWN LOOK

Step 1: Choose your platforms profile.
These can be made in any size.

Step 2: Choose your elements.
Options: magnetics or hide a tag.

CREATE YOUR OWN LOOK

JEWELRY DISPLAY

REVEAL
Shown in
Novasuede



WHISPER
Shown in
Novasuede

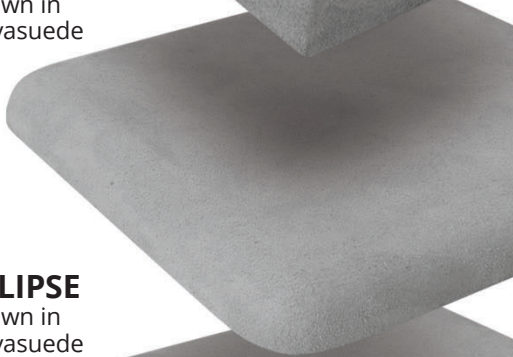

ECLIPSE
Shown in
Novasuede

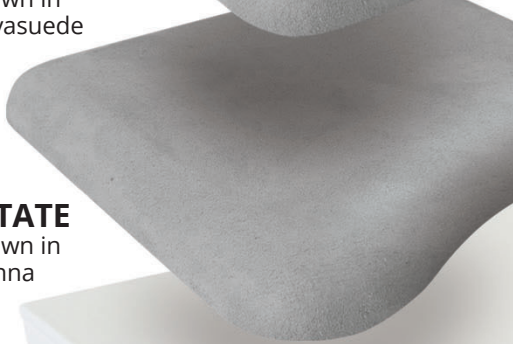

ESTATE
Shown in
Vienna



VANTAGE
Shown in
Vienna

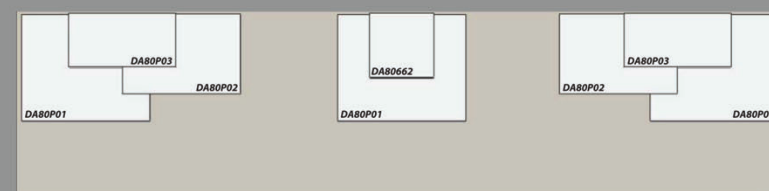
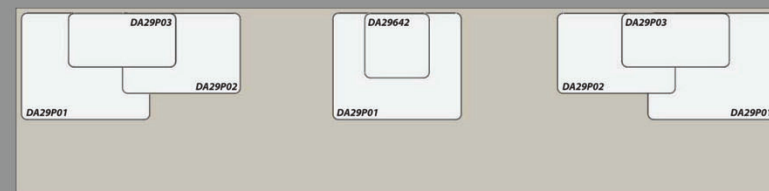
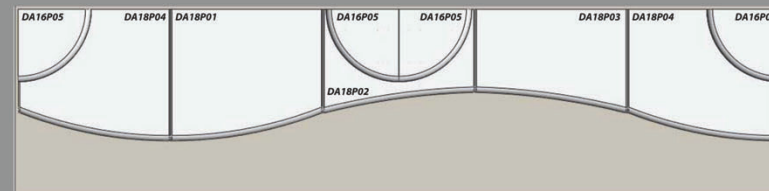
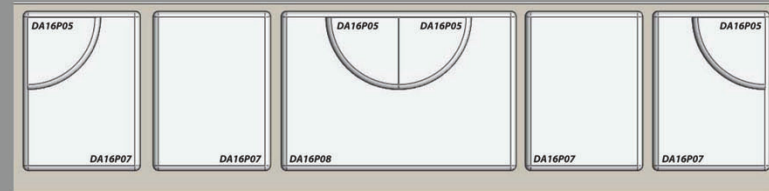
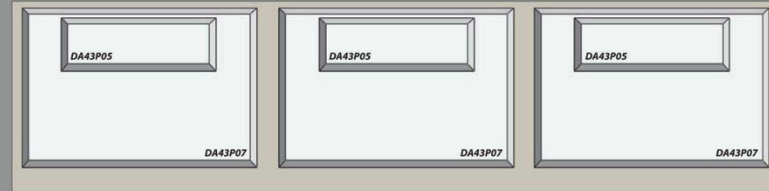

ELEMENT AND SHOWCASE PLATFORM STYLES

Call our experts for assistance.

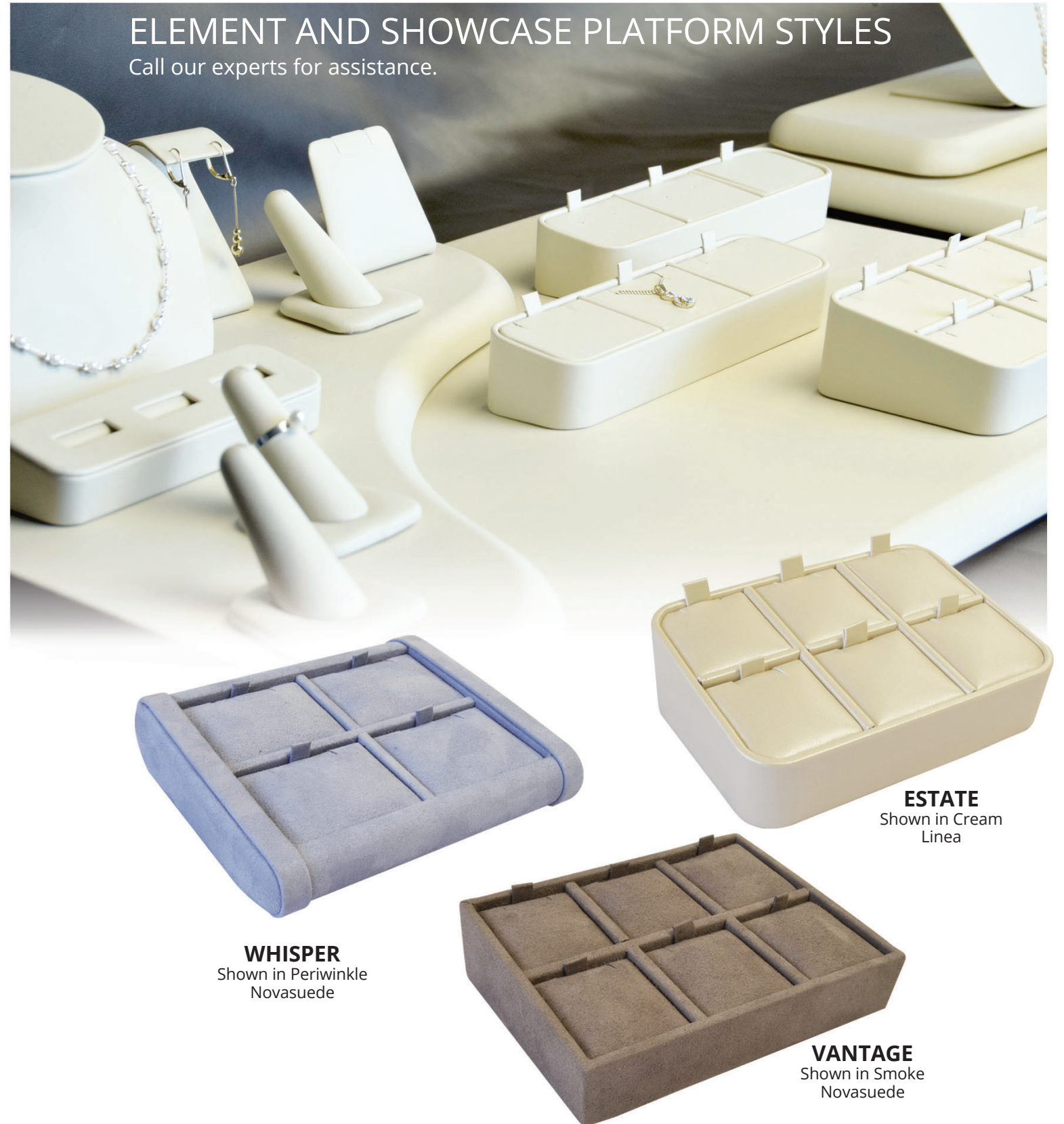

WHISPER
Shown in Periwinkle
Novasuede



ESTATE
Shown in Cream
Linea



VANTAGE
Shown in Smoke
Novasuede

JEWELRY DISPLAY

CREATE YOUR OWN LOOK

FABRICS & COLOR CHOICES

CALL OUR EXPERTS FOR ASSISTANCE.

Fabric for Floorboards - Minimum order of 2 yards x 54" wide Cut Yardage Pricing

54"	Vienna	FIF1007936
54"	Linea	FIF1037700
49"	Charisma	FIF1037722
54"	Elite	FIF1037723
54"	Nova	FIF1037724

Lead times 2 - 3 weeks.

There is a cutting charge for any order under 10 yards.

CREATE YOUR OWN LOOK

Step 3: Choose your fabric color and style. Options: metal or wood details.



Elements shown in Black Vienna Leatherette

Vienna Leatherette - Group A

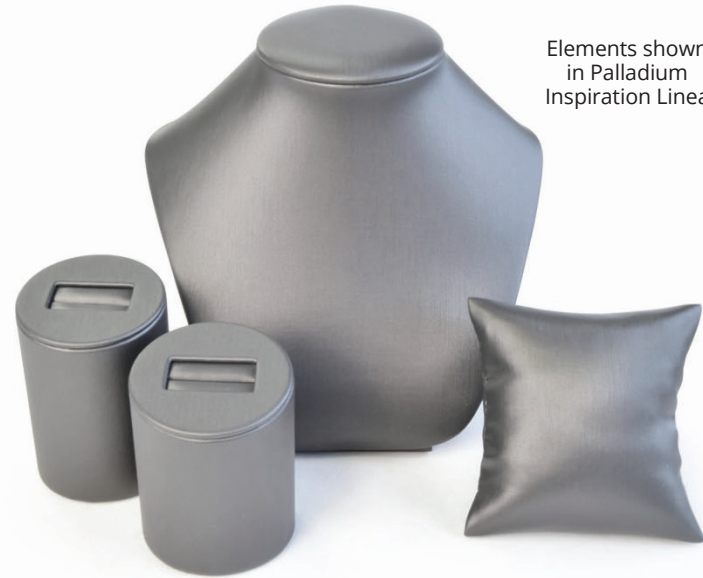

Elements shown in Palladium Inspiration Linea

Inspirations Linea - Group B

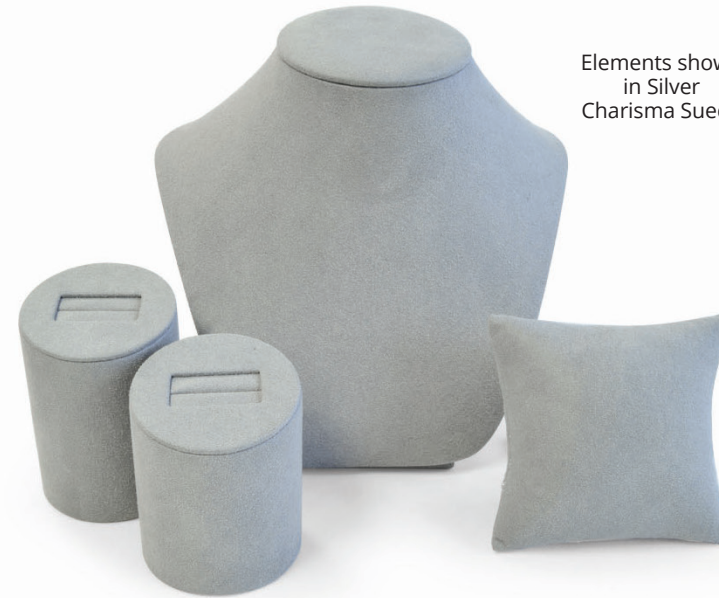

Elements shown in Silver Charisma Suede

Charisma Suede - Group B



Elements shown in Gainsborough Novasuede

Novasuede - Group C



Chalk Frost Pistachio



Moon Glow Paradiso Pecan Shell



Jade Blue Topaz Mink



Smoke Stone Grey Powder Grey



Mocha Metallic Bronze Copper



Classic Bronze Caponata Sepia



Taupe Silver Butternut



Taupe Beige Buttercup



Black Aubergine Port



Phantom Palladium Carbon



Palomino Fawn Buff



Periwinkle Sky Blue Blue Max

IN STOCK

All our in stock displays are covered in Vienna Chalk fabric.

Ring Showcase Displays

Available for immediate shipment.

Save 25% when you buy \$500 or more!

All our in stock displays are covered in Vienna Chalk fabric.

Available for immediate shipment.

IN STOCK

Pendant/Earring and Mix Showcase Displays

Save 25% when you buy \$500 or more!

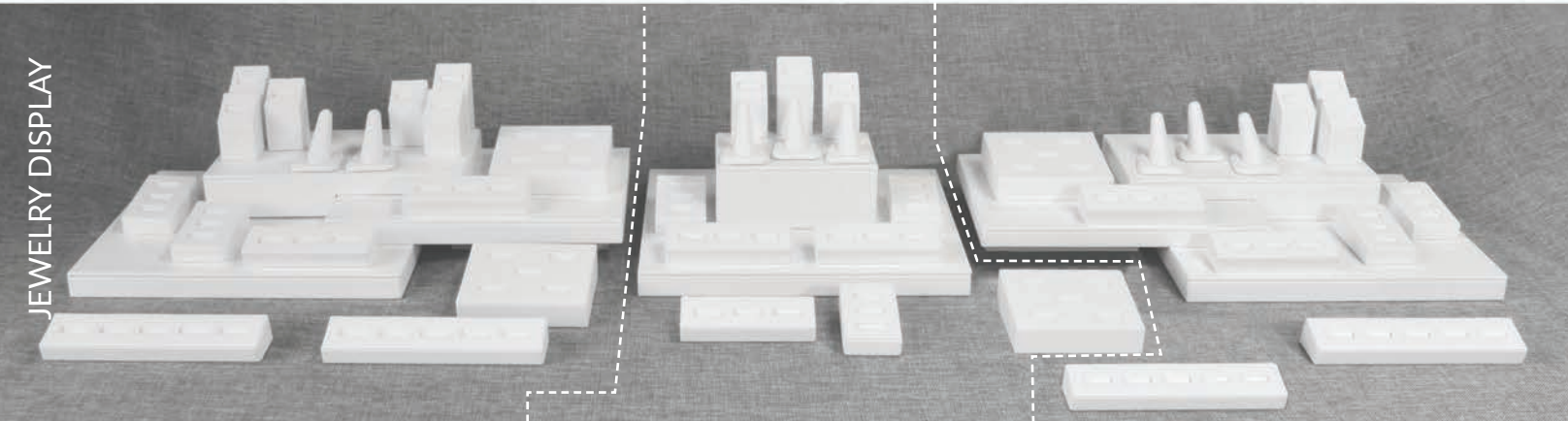

Section 1

16 sku capacity - 40 Rings

\$205.46*

*Platforms not included

Section 2

12 sku capacity - 29 Rings

\$177.89*

*Platforms not included

Section 3

14 sku capacity - 33 Rings

\$161.84*

*Platforms not included

Complete 6 foot - 102 ring element display - \$545.19

Buy \$500+ **\$408.89**

Add all platforms as shown - \$311.73

Buy \$500+ **\$233.80**

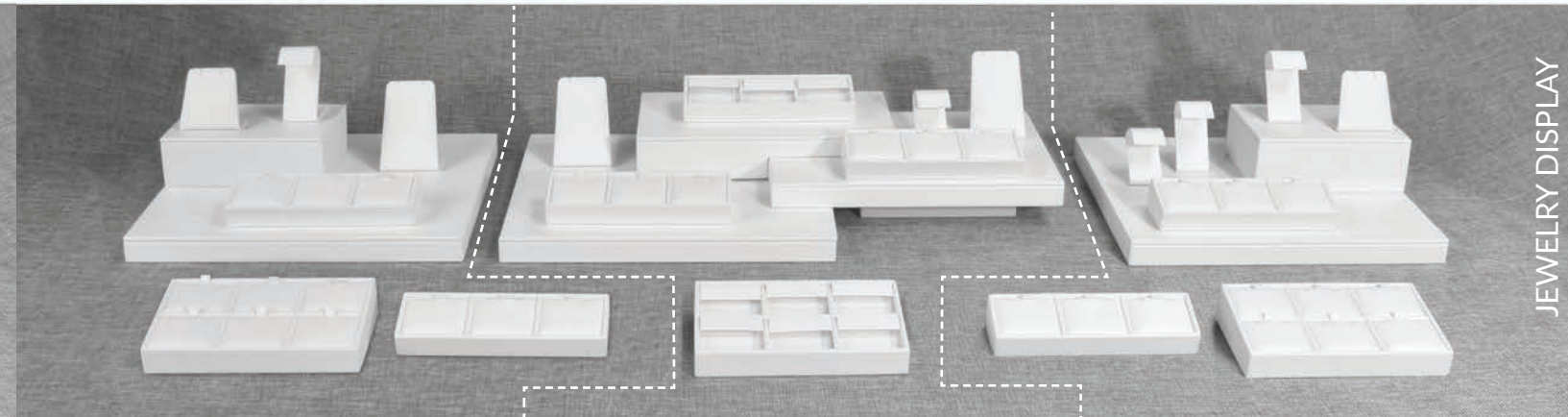

Section 1

15 sku capacity - 5 Pendants, 10 Earrings

\$101.47*

*Platforms not included

Section 2

18 sku capacity - 5 Pendants, 13 Earrings

\$90.15*

*Platforms not included

Section 3

16 sku capacity - 13 Pendants, 3 Earrings

\$90.41*

*Platforms not included

Complete 5 foot - 50 pendant/earring element display - \$282.03

Buy \$500+ **\$211.51**

Add all platforms as shown - \$257.77

Buy \$500+ **\$193.27**

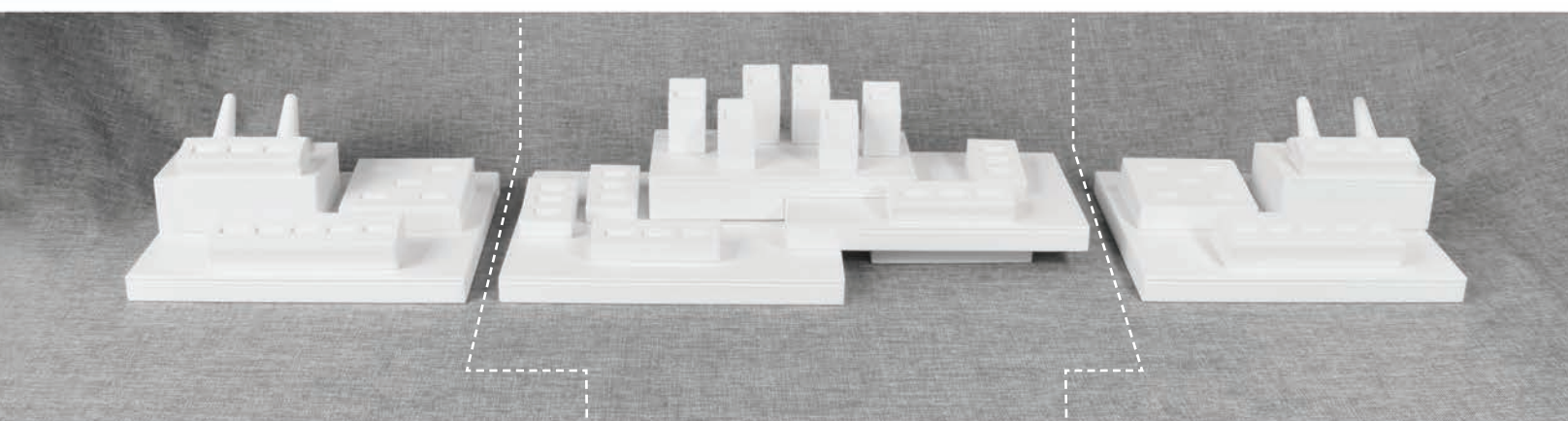

Section 1

5 sku capacity - 15 Rings

\$68.55*

*Platforms not included

Section 2

11 sku capacity - 21 Rings

\$111.46*

*Platforms not included

Section 3

5 sku capacity - 15 Rings

\$68.55*

*Platforms not included

Complete 5 foot - 51 ring element display - \$248.56

Buy \$500+ **\$186.43**

Add all platforms as shown - \$257.70

Buy \$500+ **\$193.28**

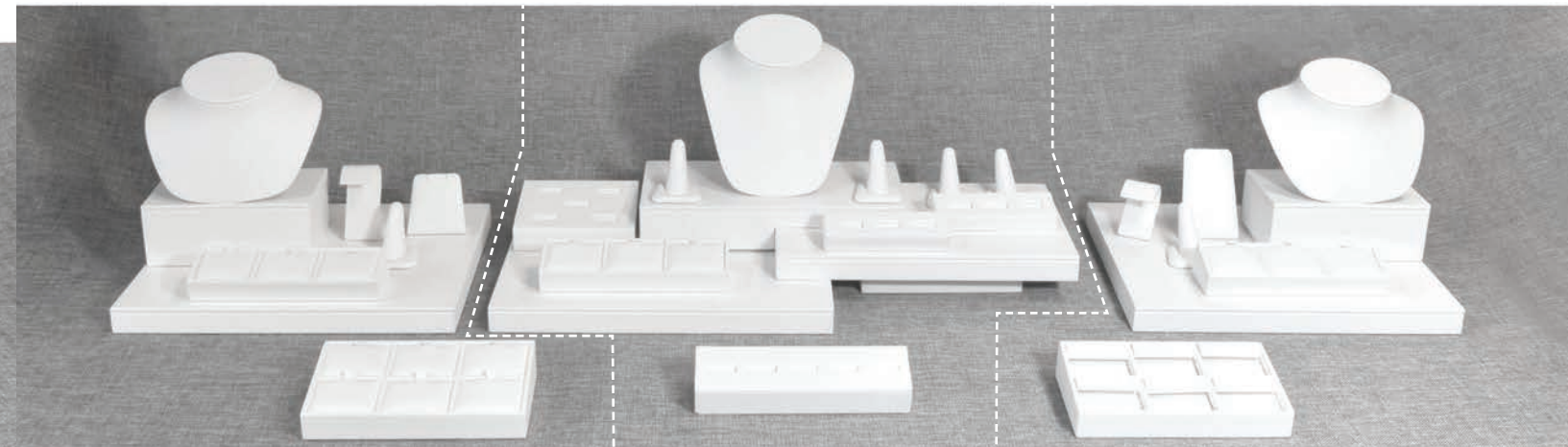

Section 1

13 sku capacity - 1 Ring, 8 Pendants, 4 Earrings

\$101.83*

*Platforms not included

Section 2

24 sku capacity - 20 Rings, 4 Pendants

\$161.42*

*Platforms not included

Section 3

13 sku capacity - 1 Ring, 2 Pendants, 10 Earrings

\$106.51*

*Platforms not included

Complete 5 foot - 50 mix element display - \$369.76

Buy \$500+ **\$277.32**

Add all platforms as shown - \$325.59

Buy \$500+ **\$244.20**





IN STOCK

All our in stock displays are covered in Vienna Chalk fabric.

Platforms and Risers

Available for immediate shipment.

Save 25% when you buy \$500 or more!

Item	Part No. / Description	Price/ea.	Item	Part No. / Description	Price/ea.
	DA80P01-SC Platform 12 x 10 x .875"	\$40.84		DA80P03-SC Platform 10 x 5 x 1.75"	\$39.01
	BUY \$500+	\$30.63		BUY \$500+	\$29.26
	DA80P02-SC Platform 11 x 7.5 x 1.875"	\$42.07		DA80332-SC Riser 3 x 3 x 2"	\$11.33
	BUY \$500+	\$31.55		BUY \$500+	\$8.50
	DA80662-SC Riser 6 x 6 x 2"	\$27.05			
	BUY \$500+	\$20.28			

* Display case floorboards are not included in the price. Material for covering your own floorboards is available and is priced by the yard. See page 65.

Platform layout suggestions



4 foot case - 26" wide, 10" deep



5 foot case - 44" wide, 10" deep



6 foot case - 52" wide, 10" deep • 19" left, 12" center and 19" right

Total price does not include applicable taxes. In stock displays and platforms are only available in VANTAGE style in Vienna fabric option.









IN STOCK

Neck Forms

All our in stock displays are covered in Vienna Chalk fabric.



Save 25% when you buy \$500 or more!

Item	Part No. / Description	Price/ea.	Item	Part No. / Description	Price/ea.
	DANF1021-SC Neck form 7.125 x 2.25 x 8.625"	\$43.07		DANF1010-SC Neck form 7.75 x 8.5 x 11"	\$65.61
	BUY \$500+	\$32.30		BUY \$500+	\$49.21
	DANF1026-SC Neck form 6 1/2 x 4 1/2 x 4"	\$25.96		DANF1029-SC Neck form 7 x 6 1/2 x 7 1/4"	\$44.16
	BUY \$500+	\$19.47		BUY \$500+	\$33.12
	DANF1028-SC Neck form 6 1/2 x 4 1/2 x 6"	\$41.30		DANF2003-SC Neck form 3 x 2 1/2 x 3 1/2"	\$16.98
	BUY \$500+	\$30.98		BUY \$500+	\$12.74
	DANF1027-SC Neck form 7 x 6 1/2 x 4 3/4"	\$57.82		DANF1034-SC Neck form 6 3/4 x 6 x 7 5/8"	\$46.96
	BUY \$500+	\$43.37		BUY \$500+	\$35.22

JEWELRY DISPLAY

JEWELRY DISPLAY

IN STOCK

All our in stock displays are covered in Vienna Chalk fabric.

Ring Stands and Trays

Available for immediate shipment.

Save 25% when you buy \$500 or more!

Item	Part No. / Description	Price/ea.	Item	Part No. / Description	Price/ea.
	DA80058UR-SC Ring stand 1 5/8 x 1 1/2 x 2 1/8"	\$9.36 BUY \$500+ \$7.02	 <i>Includes:</i> 1-DA80060UR 2-DA80059UR 2-DA80058UR	DA80070S-SC Ring stand set	\$46.02 BUY \$500+ \$34.52
	DA80059UR-SC Ring stand 1 5/8 x 1 1/2 x 2 1/2"	\$9.44 BUY \$500+ \$7.08		DA8004RV-SC 4 ring vertical bar 1 3/4 x 4 x 1"	\$15.85 BUY \$500+ \$11.89
	DA80060UR-SC Ring stand 1 5/8 x 1 1/2 x 2 3/4"	\$9.56 BUY \$500+ \$7.17		DA8005RH-SC 5 ring horizontal bar 7 1/4 x 1 5/8 x 1"	\$19.25 BUY \$500+ \$14.43
	DA28A01UR-SC Universal ring tray 2 3/8 x 2 1/4 x 1 1/2"	\$8.60 BUY \$500+ \$6.45		DA28C05UR-SC 5 universal ring tray 6 3/4 x 2 1/4 x 1 1/2"	\$16.98 BUY \$500+ \$12.74
	DA8002RV-SC 2 ring vertical bar 1 3/4 x 2 1/8 x 1"	\$11.33 BUY \$500+ \$8.50		DA28D05UR-SC 5 universal ring tray 4 5/8 x 4 x 1 1/2"	\$22.64 BUY \$500+ \$16.98
	DA8002RH-SC 2 ring horizontal bar 3 1/4 x 1 5/8 x 1"	\$11.33 BUY \$500+ \$8.50		DA28E05RD-SC 5 ring duo tray 6 3/4 x 4 x 1 1/2"	\$26.80 BUY \$500+ \$20.10
	DA8003RV-SC 3 ring vertical bar 1 3/4 x 3 x 1"	\$13.20 BUY \$500+ \$9.90		DA28E07UR-SC 7 ring tray 6 3/4 x 4 x 1 1/2"	\$26.42 BUY \$500+ \$19.82
	DA8003RH-SC 3 ring horizontal bar 4 1/2 x 1 5/8 x 1"	\$14.17 BUY \$500+ \$10.63			

All our in stock displays are covered in Vienna Chalk fabric.

IN STOCK

Ring Stands, Pendant Stands and Trays

Available for immediate shipment.

Save 25% when you buy \$500 or more!

Item	Part No. / Description	Price/ea.	Item	Part No. / Description	Price/ea.
	DA28D07UR-SC 7 universal ring tray 4 5/8 x 4 x 1 1/2"	\$26.51 BUY \$500+ \$19.89		DAF400T-SC Ring feature stand 2 5/8 x 2 1/4 x 2.625"	\$18.87 BUY \$500+ \$14.15
	DA28E08UR-SC 8 ring tray 6 3/4 x 4 x 1 1/2"	\$25.67 BUY \$500+ \$19.25		DAF400S-SC Ring feature stand 2 5/8 x 2 1/4 x 2.25"	\$18.49 BUY \$500+ \$13.87
	DA28D08UR-SC 8 universal ring tray 4 5/8 x 4 x 1 1/2"	\$23.94 BUY \$500+ \$17.96		DARF110-SC Ring finger 2 7/8 x 2 5/8 x 1 7/8"	\$7.38 BUY \$500+ \$5.53
	DA28E11UR-SC 11 ring tray 6 3/4 x 4 x 1 1/2"	\$25.67 BUY \$500+ \$19.25		DARD130-SC Ring disc min. order qty. of 12 1 1/4" Diameter	\$0.64 BUY \$500+ \$0.48
Item	Part No. / Description	Price/ea.	Item	Part No. / Description	Price/ea.
	DA350P-SC Pendant stand 2 3/8 x 1 1/2 x 3 1/2"	\$9.44 BUY \$500+ \$7.08		DA225P-SC Pendant stand 2 3/8 x 2 1/4 x 2"	\$7.55 BUY \$500+ \$5.66
	DA345P-SC Pendant stand 3 x 2 x 4"	\$17.62 BUY \$500+ \$13.21		DA234P-SC Pendant stand 2 1/2 x 2 x 3"	\$11.33 BUY \$500+ \$8.50
	DA28A01PD-SC Pendant tray 2 3/8 x 2 1/4 x 1 1/2"	\$9.82 BUY \$500+ \$7.36		DA28C03PD-SC 3 pendant tray 6 3/4 x 2 1/4 x 1 1/2"	\$22.64 BUY \$500+ \$16.98
	DA28D04PD-SC 4 pendant tray 4 5/8 x 4 x 1 1/2"	\$29.82 BUY \$500+ \$22.36		DA28D06PD-SC 6 pendant tray 4 5/8 x 4 x 1 1/2"	\$32.08 BUY \$500+ \$24.06
	DA28E06PD-SC 6 pendant tray 6 3/4 x 4 x 1 1/2"	\$32.08 BUY \$500+ \$24.06		DA28E08PD-SC 8 pendant tray 6 3/4 x 4 x 1 1/2"	\$35.86 BUY \$500+ \$26.90

IN STOCK

Earring Stands and Trays

Save 25% when you buy \$500 or more!

Available for immediate shipment.

All our in stock displays are covered in Vienna Chalk fabric.

Item	Part No. / Description	Price/ea.	Item	Part No. / Description	Price/ea.
	DACES14-SC Earring tree stand 2 x 2 x 3"	\$10.62 BUY \$500+ \$7.97		DACES13-SC Earring stand 1 1/4 x 1 7/8 x 2 3/4"	\$9.38 BUY \$500+ \$7.04
	DACES36-SC Earring stand 2 3/4 x 1 3/4 x 3 1/2"	\$10.62 BUY \$500+ \$7.97		DASLD6-SC Earring sled 2 x 8 1/4 x 2"	\$11.33 BUY \$500+ \$8.50
	DA28A01FE-SC Flap earring tray 2 3/8 x 2 1/4 x 1 1/2"	\$11.33 BUY \$500+ \$8.50		DA28A01PE-SC Pierced earring tray 2 3/8 x 2 1/4 x 1 1/2"	\$9.72 BUY \$500+ \$7.29
	DA28C03FE-SC 3 flap earring tray 6 3/4 x 2 1/4 x 1 1/2"	\$18.87 BUY \$500+ \$14.15		DA28C03PE-SC 3 pierced tray 6 3/4 x 2 1/4 x 1 1/2"	\$20.38 BUY \$500+ \$15.28
	DA28D04FE-SC 4 flap earring tray 4 5/8 x 4 x 1 1/2"	\$29.82 BUY \$500+ \$22.36		DA28D04PE-SC 4 pierced earring tray 4 5/8 x 4 x 1 1/2"	\$26.21 BUY \$500+ \$19.66
	DA28D06FE-SC 6 flap earring tray 4 5/8 x 4 x 1 1/2"	\$33.97 BUY \$500+ \$25.48		DA28D06PE-SC 6 pierced earring tray 4 5/8 x 4 x 1 1/2"	\$36.79 BUY \$500+ \$27.59
	DA28E06FE-SC 6 flap earring tray 6 3/4 x 4 x 1 1/2"	\$33.97 BUY \$500+ \$25.48		DA28E06PE-SC 6 pierced earring tray 6 3/4 x 4 x 1 1/2"	\$32.08 BUY \$500+ \$24.06
	DA28E08FE-SC 8 flap earring tray 6 3/4 x 4 x 1 1/2"	\$40.93 BUY \$500+ \$30.70		DA28E08PE-SC 8 pierced earring tray 6 3/4 x 4 x 1 1/2"	\$32.08 BUY \$500+ \$24.06

All our in stock displays are covered in Vienna Chalk fabric.

IN STOCK

Earring, Bangle and Bracelet Stands, Chain Ramps, Counter Pads and Signage

Available for immediate shipment.

Save 25% when you buy \$500 or more!

Item	Part No. / Description	Price/ea.	Item	Part No. / Description	Price/ea.
	05000755 Earring stand 7 x 4 1/2 x 1 3/4"	\$30.03 BUY \$500+ \$22.52		DABS185-SC Bracelet sled 1 1/4 x 9 1/4 x 1 3/4"	\$9.32 BUY \$500+ \$6.99
	DASBS12-SC Bangle "T" bar 7 1/8 x 2 3/4 x 5 1/4" (dia. 1.625")	\$30.09 BUY \$500+ \$22.57		DABS485-SC Bracelet sled 4 x 9 5/8 x 1 7/8"	\$16.11 BUY \$500+ \$12.08
	DAJP350V-SC Bracelet pillow w/stand 3 1/4 x 3 1/4 x 3 1/4"	\$10.50 BUY \$500+ \$7.88		DADB425-SC Bracelet dome 4 1/8 x 5 1/8 x 2 1/2"	\$31.74 BUY \$500+ \$23.81
	DACHR16-SC Chain ramp / Rem. pad 10 1/4 x 16" chain pad 10 3/4 x 16 1/2 x 3 1/2"	\$113.28 BUY \$500+ \$84.96		DA1081R-SC Pres. tray w/ring 10 1/2 x 8 5/8 x 1"	\$48.23 BUY \$500+ \$36.17
	DACW884-SC Chain display wedge 8 x 8 x 3.75"	\$48.69 BUY \$500+ \$36.52		DAPCF5510-SC Counter pad plain 5 1/4 x 10 1/4 x 3/4" closed 10 3/4 x 10 1/4 x 3/8" open	\$34.24 BUY \$500+ \$25.68
				DASB211 Sign stand 2 3/4 x 2 3/16 x 1 1/4"	\$10.07 BUY \$500+ \$7.55

IN STOCK

All our in stock displays are covered in Vienna Chalk fabric.

Specialty Items

Available for immediate shipment.

Save 25% when you buy \$500 or more!

JEWELRY DISPLAY

Item	Part No. / Description	Price/ea.	Item	Part No. / Description	Price/ea.
	05000300-SC Loose Diamond Arch 11.5" x 4" x 1.5"	\$70.33		05000301 Diamond Cup 1.125" diameter x .75"	\$11.33
	BUY \$500+	\$52.75		BUY \$500+	\$8.50
	05000299-SC Pearl Half Moon 8" x 8" x 3.25"	\$90.39		05000298-SC Wave Chain Ramp 10.125" x 9" x 2.625"	\$83.87
	BUY \$500+	\$67.79		BUY \$500+	\$62.91
	Sign size: 3.9375" x 2.375" 05000300 Acrylic Sign 1.1875" x 4" x 2.75"	\$14.45		05000302 Bevelled Edge Mirror 8.5" x 8.25" x 5.5"	\$51.92
	BUY \$500+	\$10.84		BUY \$500+	\$38.94
	05000581-SC Pendant/earring tray with PVC signage 4.75" x 9.5" x 2"	\$43.66		36301103 Small Vision Box 2.68 x 2.68 x .75"	\$1.00
	BUY \$500+	\$32.75		36302103 Medium Vision Box 3.5 x 3.5 x .75"	\$1.33
				36303103 Large Vision Box 4.25 x 4.25 x .75"	\$1.66
			Minimum order 12		
				69300103 Base for Vision Box 2.24 x 2.24 x .62"	\$0.83
				Bag of 12	

JEWELRY STORAGE by MELE AND Co



IN STOCK

Visit Melejewelrybox.com for order information.

Jewelry Storage by MELE AND Co



THE STOWAWAY LINE

- Vegan leather with coordinating zipper pull
- Cream anti-tarnish microsuede interior lining and metal zipper closure
- Custom leather option upon request
- Branded cleaning cloth and reusable dust bag included



The Essentials Colour Line

Black - 62 Buff - 44 Ecru - 10

Code	Description	Size (inches)	Pack		Black - 62	Buff - 44	Ecru - 10
A 00629__	Bento	7 x 6.25 x 3.125	2	Bento	✓	✓	—
B 00518__	Duo	6.875 x 3 x 5.25	2	Duo	✓	✓	—
C 00513__	Duo Mini	5 x 3.75 x 2	4	Duo Mini	✓	✓	✓
D 00626__	Stow and Go	5 x 5 x 2.25	2	Stow and Go	✓	✓	✓
E 00618__	Stow and Go Mini	3.5 (D) x 1.625	4	Stow and Go Mini	✓	✓	✓

Visit melejewelrybox.com for these plus other fashion forward, timeless classics and youthful collections!



Everly Kate Kelby Geneva Olympia Grant

BAGS

EUROTOTES, PAPER, POLY & REUSABLE



IN STOCK

Rope Handle Eurototes

BAGS



08V - Silver

Linen Paper Detail

Vantage II Eurototes Available Colors



08V - Silver
Matches Vantage Silver
Hinged Packaging
See page 29.

07V - Gold
Matches Vantage Gold
Hinged Packaging
See page 29.

Vantage II Eurototes

- 150 gsm uncoated art paper
- 5 mm pp cord knotted handles
- Folded top turn and cardboard reinforced bottom
- Minimum order is 100 per color per size

CODE	SIZE (inches)
A 230606 _ _ _	6 x 3.5 x 6 x 3.5
B 231008 _ _ _	10.5 x 5 x 8.5 x 5

Estimated lead time: 2 - 3 weeks for printed items from approved art.



FOIL PRINT
100+ 32¢ each
1000+ 29¢ each
2500+ 24¢ each

Eclipse and Geo Eurototes Available Colors



56G - Purple
Matches Geo Purple
Hinged Packaging
See page 23.

27G - Bronze
Matches Geo Bronze
Hinged Packaging
See page 23.



27G - Bronze

Shimmer Paper Detail

Eclipse and Geo Eurototes

- 150 gsm uncoated art paper
- 5 mm pp cord knotted handles
- Folded top turn and cardboard reinforced bottom
- Minimum order is 100 per color per size

66E - Aubergine
Matches Eclipse Aubergine
Hinged Packaging
See page 19.

81E - Blue
Matches Eclipse Blue
Hinged Packaging
See page 19.

IN STOCK

Rope Handle Eurototes

BAGS



Laminated Eurotote with Rope Handle

- Matte lamination
- 157 gsm art paper
- 5 mm pp cord knotted polypropelene handle
- Folded top turn and cardboard reinforced bottom
- Minimum order is 100 per color per size

CODE	TYPE	SIZE (inches)
A 239606 _ _	Novelty	6 x 3.5 x 6 x 3.5
B 239709 _ _	Small gift	9 x 3.5 x 7 x 3.5
C 239810 _ _	Gift	8 x 4 x 10 x 4
D 230908 _ _ T	Trapezoid	9/7 x 4 x 8.5 x 4
E 238116 _ _	Fashion	16 x 6 x 12 x 6
F 231011 _ _	Watch	10 x 5 x 11 x 5

Estimated lead time: 2 - 3 weeks for printed items from approved art.



DIGITAL PRINT
100+ \$2.25 each
1000+ \$1.99 each
300 bags minimum



FOIL PRINT
100+ 32¢ each
1000+ 29¢ each
2500+ 24¢ each



	15-Black	00-White	07-Gold	08-Silver	42-Brown	11-Blue	10-Green
Novelty	✓	✓	✓	✓	✓	✓	✓
Small Gift	✓	✓	✓	✓	✓	✓	✓
Gift	✓	✓	✓	✓	✓	✓	✓
Trapezoid	✓	✓	✓	—	✓	—	—
Fashion	✓	✓	✓	✓	✓	—	—
Watch	✓	✓	✓	—	—	—	—

All print orders subject to set-up charges. Applicable artwork, and plate charges may apply. See page 122.

IN STOCK

Luxury Grosgrain Handle Eurototes

IN STOCK

All Paper Eurototes

BAGS

BAGS



Luxury Grosgrain Handle Eurototes

- Gloss and matte lamination
- 158 gsm art paper
- 7/8" matching grosgrain, knotted handles
- Fold over top turn and cardboard reinforced bottom
- Minimum order is 100 per color per size

CODE	SIZE (inches)	CASE PACK
A 230606	6 x 3 x 6 x 3	100
B 230810	8 x 4 x 10 x 4	100
C 231209	12.5 x 4.5 x 9 x 4.5	100
D 231612	16 x 6 x 12 x 6	100
E 232014	20 x 6 x 14 x 6	100

* champagne and pewter not available in this size.

Available Colors



15BM Black Matte 15BG Black Gloss 02C Champagne 08P Pewter 00W White

Estimated lead time: 2 - 3 weeks for printed items from approved art.

DIGITAL PRINT
 100+ \$2.25 each
 1000+ \$1.99 each
 300 bags minimum

FOIL PRINT
 100+ 32¢ each
 1000+ 29¢ each
 2500+ 24¢ each

All Paper Eurotote with Paper Rope Handle

- 100% recyclable
- 40% post-consumer waste
- 190 gsm uncoated paper
- 8 mm paper cord knotted handles
- Folded top turn and cardboard reinforced bottom
- Minimum order is 100 per color per size

CODE	SIZE (inches)	CASE PACK
A 230606	6 x 3.5 x 6 x 3.5	100
B 230810	8 x 4 x 10 x 4	100
C 231013	10 x 5 x 13 x 5	100
D 231612	16 x 6 x 12 x 6	100



Available Colors



75AK Kraft 00AW White 15AB Black 28AC Cream

Estimated lead time: 2 - 3 weeks for printed items from approved art.

FOIL PRINT
 100+ 32¢ each
 1000+ 29¢ each
 2500+ 24¢ each

CREATE YOUR OWN LOOK

Full Color Paper Eurototes

Make a creative impression...
the combinations are endless!



Prices include up to 2 ink print colors:

TYPE	SIZE (inches)
Novelty	6 x 3.5 x 6 x 3.5
Small Gift	9 x 3.5 x 7 x 3.5
Gift	8 x 4 x 10 x 4
Trapezoid	9/7 x 4 x 8.5 x 4
Wine	3.375 x 3.5 x 13 x 3.5
Fashion	16 x 6 x 12 x 6
Saville	16 x 6 x 19 x 6

Prices include 4 color process print:

TYPE	SIZE (inches)
Novelty	6 x 3.5 x 6 x 3.5
Small Gift	9 x 3.5 x 7 x 3.5
Gift	8 x 4 x 10 x 4
Trapezoid	9/7 x 4 x 8.5 x 4
Wine	3.375 x 3.5 x 13 x 3.5
Fashion	16 x 6 x 12 x 6
Saville	16 x 6 x 19 x 6

- Combination foil print and ink printing available.
- No charge for printing plates (proof charge applies)
- Substitute a satin ribbon handle for the standard rope
- Add metal grommets to your bag



Unique printing options available.
Double Stamping shown here.

Estimated lead time: 14 - 16 weeks for delivery from approved art.



Create Your Own Look:
Choose your bag style.
Send us your artwork.
For 100% full color design, speak to your sales representative.

SPECIAL ORDER

5th Avenue Eurototes



Thick Woven Handle Detail



5th Avenue Eurototes

- Embossed laminated finish with printed gloss coordinating color interior
- 210 gsm
- Thick woven handles, top slit style
- W fold & removable bottom board
- Minimum order is 100 per color per size

CODE	SIZE (inches)	CASE PACK
A 245820 __	8 x 3.5 x 6 x 3.5	100
B 245821 __	12.5 x 4.5 x 9 x 4.5	100
C 245822 ___	17 x 6 x 12.75 x 6	100

Estimated lead time: 3 - 5 weeks for printed items from approved art.

DIGITAL PRINT
100+ \$2.25 each
1000+ \$1.99 each
300 bags minimum

FOIL PRINT
100+ 32¢ each
1000+ 29¢ each
2500+ 24¢ each

Available Colors



15 Black/Gloss Black 08 Silver/Gloss Silver 00 White/Gloss Silver

All print orders subject to set-up charges. Applicable artwork, and plate charges may apply. See page 122.

SPECIAL ORDER

SPECIAL ORDER

Paper Shoppers

BAGS

BAGS



Manhattan Eurototes

- Uncoated paper with varnish finish*
- 180 gsm wood-free paper
- 5/8" poly/cotton twill knotted handle
- Folded top turn and cardboard reinforced bottom
- 200 gsm kraft paper 75% recycled** (color chart reference)

CODE	TYPE	SIZE (inches)	CASE PACK
A 245845	Mini	5 x 4 x 6 x 4	100
B 245841	Petite	8 x 4 x 10 x 4	100
C 245843	Vanity	10 x 5 x 13 x 5	100
D 245844	Fashion	16 x 6 x 12 x 6	100
E 245860	X-Large	20 x 6 x 14 x 6	50
F 245898	Bottle Bag	4.5 x 4.5 x 15 x 4.5	100
G 245856	Wide Gusset - Medium	12.5 x 12 x 12 x 12	100
H 245857	Wide Gusset - Large	16 x 12 x 11 x 12	100



12" Wide Gussets!



Available Colors	15* Black	00* White	75** Kraft	08* Grey	81* Ivory	09* Red	41* Fuchsia	11** Navy	10* Green
Mini	✓	✓	✓	✓	—	✓	✓	✓	✓
Petite	✓	✓	✓	✓	✓	✓	✓	✓	✓
Vanity	✓	✓	✓	✓	✓	✓	✓	✓	✓
Fashion	✓	✓	✓	✓	✓	✓	✓	✓	✓
X-Large	✓	✓	✓	—	—	—	—	—	—
Bottle	✓	✓	✓	—	—	✓	—	—	—
Wide Gusset Medium	✓	✓	✓	—	—	—	—	—	—
Wide Gusset Large	✓	✓	✓	—	—	—	—	—	—

Estimated lead time: 3 - 5 weeks for printed items from approved art.

DIGITAL PRINT
100+ \$2.25 each
1000+ \$1.99 each
300 bags minimum

FOIL PRINT
100+ 32¢ each
1000+ 29¢ each
2500+ 24¢ each

SPECIAL ORDER

Paper Shoppers

New



Totally Trim Paper Shoppers

- Twist paper handle with bottom gusset
- 100% recyclable and biodegradable
- Minimum order per color per size



CODE	DESCRIPTION	SIZE (inches)	CASE PACK
245111	Small (90 gsm)	11.8 x 9.8 x 3.9	300
245114	Medium (100 gsm)	14.2 x 10.6 x 3.9	250
245118	Large (100 gsm)	18.1 x 12.4 x 5.9	300
245119	Extra Large (100 gsm)	19.7 x 16.3 x 5.9	250

DIGITAL PRINT
100+ \$2.25 each
1000+ \$1.99 each
300 bags minimum

INK PRINT
100+ 31¢ each
1000+ 26¢ each
2500+ 22¢ each

FOIL PRINT
100+ 32¢ each
1000+ 29¢ each
2500+ 24¢ each

Estimated lead time: 2 - 3 weeks for printed items from approved art.



Tints and Pinstripe on Kraft

- Twist paper handle
- 120 gsm paper



Pinstripe Detail

Tints on Kraft



Pinstripe on Kraft



CODE	DESCRIPTION	SIZE (inches)	CASE PACK
230508	Prime	5 x 3 x 8 x 3	250
245114	Petite	8 x 4.5 x 10	250
245118	Fashion	16 x 6 x 12 x 6	250

DIGITAL PRINT
250+ \$2.25 each
1000+ \$1.99 each
300 bags minimum

INK PRINT
250+ 31¢ each
1000+ 26¢ each
2500+ 22¢ each

FOIL PRINT
250+ 32¢ each
1000+ 29¢ each
2500+ 24¢ each

Estimated lead time: 3 - 4 weeks for printed items from approved art.

All print orders subject to set-up charges. Applicable artwork, and plate charges may apply. See page 122.

All print orders subject to set-up charges. Applicable artwork, and plate charges may apply. See page 122.

CREATE YOUR OWN LOOK

Full Color Simply
Paper Shoppers
Make a creative impression...
the combinations are endless!



Simply Paper Shoppers

Kraft with paper twist handles, print 1 color on 2 sides <25%

TYPE	SIZE (inches)	CASE PACK
Prime	5.25 x 3.5 x 8.25	250
Petite	8 x 4 x 10	250
Vanity	10 x 5 x 13	250
Celebrity	13 x 6 x 15.5	250
Fashion	16 x 6 x 12	250
Saville	16 x 6 x 19	200
Universal	18 x 6 x 19	200
Wine	5.25 x 3.5 x 13	250

Any 2 Sizes
Minimum 3000
Special Pricing

White with paper twist handles, print 1 color on 2 sides <25%

TYPE	SIZE (inches)	CASE PACK
Prime	5.25 x 3.5 x 8.25	250
Petite	8 x 4 x 10	250
Vanity	10 x 5 x 13	250
Celebrity	13 x 6 x 15.5	250
Fashion	16 x 6 x 12	250
Saville	16 x 6 x 19	200
Universal	18 x 6 x 19	200
Wine	5.25 x 3.5 x 13	250

Any 2 Sizes
Minimum 3000
Special Pricing



Create Your Own Look:
Choose your bag style.
Send us your artwork.
For 100% full color
design, speak to your
sales representative.



96% Recycled Material

- Minimum 5,000 per size or any 2 sizes, minimum 3000 per size
- Add a second color
- Go 100% ink coverage
- Add a rope handle

Estimated lead time: 12 - 14 weeks for printed items from approved art.



90%
Post Consumer
Waste



Available Colors

	12- Kraft	00- White	35 - Black	41 - Navy	07 - Gold	08- Silver
Prime	✓	✓	✓	✓	✓	✓
Petite	✓	✓	✓	✓	✓	✓
Vanity	✓	✓	—	—	—	—
Celebrity	✓	✓	—	—	—	—
Fashion	✓	✓	✓	✓	✓	✓
Saville	✓	✓	✓	✓	✓	✓
Universal	✓	✓	✓	✓	✓	✓
Wine	✓	✓	—	—	—	—



DIGITAL PRINT
100+ \$2.45 each
1000+ \$2.25 each
300 bags minimum



FOIL PRINT
100+ 32¢ each
1000+ 29¢ each
2500+ 24¢ each



INK PRINT
100+ 31¢ each
1000+ 26¢ each
2500+ 22¢ each

Please allow 2 - 3 weeks for printed items from approved art.

IN STOCK Paper Shoppers

**Sturdy, durable.
Our best value bags.**

Paper Twist Handle Shopping Bags

- 100% recyclable
- Kraft: 90% post-consumer waste/ White: 100% virgin paper
- 80 gsm paper
- Minimum order is 250/200 per color per size

CODE	TYPE	SIZE (inches)	CASE PACK
230508 __ *	Prime	5 x 3.5 x 8 x 3.5	250
230809 __	Petite	8 x 4.5 x 10.75 x 4.5	250
230914 __	Vanity	10 x 5 x 13 x 5	250
231315 __	Celebrity	13 x 6 x 15 x 6	250
231611 __	Fashion	16 x 6 x 12 x 6	250
231619 __	Saville	16 x 6 x 19 x 6	200
231819 __	Universal	18 x 7 x 18.75 x 7	200
230513 __	Wine Shopper	5.25 x 3.5 x 13	250

* White and Kraft is 230508__P

* Black, Navy, Gold and Silver 230508__PR



DIGITAL PRINT
100+ \$2.45 each
1000+ \$2.25 each
300 bags minimum



FOIL PRINT
100+ 32¢ each
1000+ 29¢ each
2500+ 24¢ each



INK PRINT
100+ 31¢ each
1000+ 26¢ each
2500+ 22¢ each

Please allow 2 - 3 weeks for printed items from approved art.

Damask Paper Shoppers

- 120 gsm paper
- Minimum order is 100 per size

CODE	TYPE	SIZE (inches)	CASE PACK
23080915D	Petite	8 x 4 x 10 x 4	100
23101315D	Vanity	10 x 5 x 13 x 5	100
23161215D	Fashion	16 x 6 x 12 x 6	100



DIGITAL PRINT
100+ \$2.45 each
1000+ \$2.25 each
300 bags minimum



FOIL PRINT
100+ 32¢ each
1000+ 29¢ each
2500+ 24¢ each



INK PRINT
100+ 31¢ each
1000+ 26¢ each
2500+ 22¢ each

Please allow 2 - 3 weeks for printed items from approved art.

All print orders subject to set-up charges. Applicable artwork, and plate charges may apply. See page 122.

IN STOCK

Paper Shoppers

The Mission Green Sustainable Solution for single-use plastic merchandise shoppers.



Kraft Paper Bag with Die Cut Handles

- 70% post-consumer recycled material
- 90 gsm kraft paper
- 125 gsm kraft paper
- Durable reinforced handles
- Minimum order is 250 per color per size

CODE	SIZE (inches)	CASE PACK
White:		
23101300WF	10 x 3.14 x 13 x 3.14	250
23141800WF	14 x 3.14 x 18 x 3.14	250
Kraft:		
23141812KF	14 x 3.14 x 18 x 3.14	250



Merchandise Die Cut Bags

- Reinforced fold-over handle plus side gusset
- 80 gsm paper

CODE	SIZE (inches)	CASE PACK
23081275	8 x 2 x 12	500
23101575	10 x 2 x 15	500
23141875	14 x 4 x 18	250



Merchandise Bags

- 110 gsm paper

CODE	SIZE (in)	CASE PACK
230609 __	6 x 9	2000
230710 __	7 x 10	500
230912 __	9 x 12	500
231114 __	11 x 14	500
231316 __	13 x 16	500



DIGITAL PRINT
100+ \$2.25 each
1000+ \$1.99 each
300 bags minimum

FOIL PRINT
100+ 32¢ each
1000+ 29¢ each
2500+ 24¢ each

INK PRINT
100+ 31¢ each
1000+ 26¢ each
2500+ 22¢ each

Please allow 2 - 3 weeks for printed items from approved art.

IN STOCK

Paper Shoppers



Tamper Proof Strips Across Both Sets of Handles

Food Service Kraft Paper Shoppers

- Sturdy and durable
- 110 gsm
- Made from 100% recycled kraft paper



CODE	DESCRIPTION	SIZE (inches)	CASE PACK
A 23121775F	SOS Shopper	12 x 7 x 17 x 7	250
B 23141512F	Paper Twist with Tamper Tape	14 x 10 x 15.5 x 10	200

DIGITAL PRINT
100+ \$2.15 each
1000+ \$1.99 each
300 bags minimum

INK PRINT
100+ 31¢ each
1000+ 26¢ each
2500+ 22¢ each

FOIL PRINT
100+ 32¢ each
1000+ 29¢ each
2500+ 24¢ each

Please allow 2 - 3 weeks for printed items from approved art.

All print orders subject to set-up charges. Applicable artwork, and plate charges may apply. See page 122.

All print orders subject to set-up charges. Applicable artwork, and plate charges may apply. See page 122.

CREATE YOUR OWN LOOK

Full Color Simply Poly Shopping Bags

Make a creative impression...
the combinations are endless!



Poly Shopping Bags

Customize simply and affordably.

CODE	TYPE	STANDARD PRINT SIZE
550907	Small Gift	5" wide
550414	Wine	2.5" wide
550810	Petite	5" wide
551612	Fashion	9" wide
551816	Majestic	10" wide

- Print two sides in 1 ink color (maximum 25% ink coverage)
- Constructed of 3.0 mil high density poly
- Coordinating poly loop handles included in price
- Poly Shoppers minimum quantity 3,000 per size

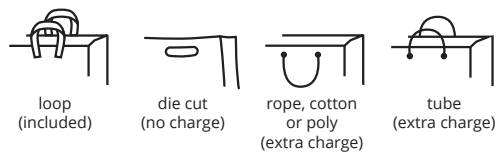

No Plate Charges*

*Does not include process plates.

Poly Merchandise Bags

CODE	SIZE (in)	STANDARD PRINT SIZE
550912	9 x 12	6" wide
551114	11 x 14	7" wide
551216	12 x 16 + 3	8" wide
551416	14 x 16 + 3	10" wide
551720	17 x 20 + 4	12" wide
551816	18 x 16 + 4	13" wide
552020	20 x 20 + 4	14" wide
552024	20 x 24 + 4	14" wide

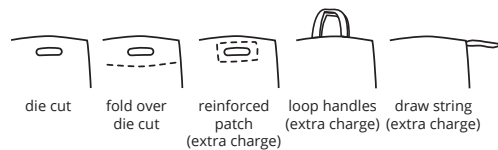

- Constructed of 1.5 mil gauge poly.
- Minimum quantity 5,000 (small sizes)/ 3,000 (large sizes).
- Print two sides in 1 ink color (maximum 25% ink coverage).



Create Your Own Look:
Choose your bag style.
Send us your artwork.
For 100% full color design, speak to your sales representative.

Estimated lead time: 14 - 16 weeks for printed items from approved art.

IN STOCK Poly Shoppers



Estimated lead time: 2 - 3 weeks for printed items from approved art.

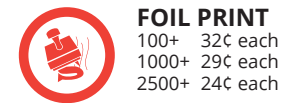

FOIL PRINT
100+ 32¢ each
1000+ 29¢ each
2500+ 24¢ each

Frosted Translucent Bags

- 2.0 mil clear HDPE merchandise, and 3.0 mil clear HDPE shoppers
- Minimum order one case pack
- Please allow 2 - 3 weeks for printed items from approved art

CODE	TYPE	GAUGE	SIZE (in)	CASE PACK
A 55091200E	Merchandise	2.0	9 x 12	1000
B 55141800E	Merchandise	2.0	14 x 18 + 3	1000
C 55081000E	Petite Shopper	3.0	8 x 4 x 10 x 4	250
D 55161200E	Fashion Shopper	3.0	16 x 6 x 12 x 6	250
E 55181600E	Majestic Shopper	3.0	18 x 6 x 16 x 6	250



Foil Printed Merchandise Bags

- Constructed of 1.75 mil low density poly
- Foil Printing is available on one side only and is included in the price of the printed bags
- Minimum one case pack, printed and unprinted
- Die charge extra
- For no-print option please add N to code number

CODE	HANDLE TYPE	SIZE (inches)	CASE PACK
A 220609 __ *	Notion	6 x 9	1000
B 220811 __ *	Die Cut	8.25 x 11	1000
C 221114 __ *	Die Cut	11 x 14	1000
D 221418 __	Die Cut	14.5 x 18	1000
E 221721 __	Patch	16.5 x 20 + 4	500

* Gold available in 3 sizes only

Estimated lead time: 2 - 3 weeks for printed items from approved art.

All print orders subject to set-up charges. Applicable artwork, and plate charges may apply. See page 122.

CREATE YOUR OWN LOOK

Reusable Fabric Style Shoppers

Make a creative impression...
the combinations are endless!



Full Color Laminated Bags

- Plates extra per design/side.
Additions for extra charge
- Add matte lamination /bag
 - Add a carded bottom /bag
 - Zipper top /bag
 - Gusset print /bag

Shopping Bags (inches)

- 9 x 4 x 11 x 4
- 11 1/4 x 4 1/4 x 12 x 4 1/4
- 14 x 4 x 16 x 4
- 16 x 6 x 12 x 6
- 16 x 5 x 15 x 5

80 GSM NON-WOVEN
SILK SCREEN PRINT ONE COLOR 2 SIDES
1"X24" HANDLES - "X" STITCH

100 GSM NON-WOVEN WITH LAMINATION
PRINT 4 COLOR PROCESS
1"X24" PP WEBBING HANDLES - "X" STITCH

120 GSM PP WOVEN WITH LAMINATION
PRINT 4 COLOR PROCESS
1"X24" PP WEBBING HANDLES - "X" STITCH



Non-woven Polypropylene

Soft, yet durable. Use this for light to medium weight loads.



Woven Polypropylene

Our strongest material. This rigid weave will handle heavy items.

Many more sizes available
- just ask!



Create Your Own Look:
Choose your bag style.
Send us your artwork.
For 100% full color design, speak to your sales representative.

- Minimum quantity 2,000 per size

Estimated lead time: 14 - 16 weeks for printed items from approved art.

IN STOCK

Reusable RPET Laminated Tote



Mission Green Sustainable solution made with 80% recycled RPET + Lamination

- 100 gsm with matte lamination
- Corner sewn style with RPET handle
- Small bag made with 7 recycled plastic bottles
- Large bag made with 11 recycled plastic bottles
- Eco-friendly, durable, recycled

RPET is known as Recycled Polyethylene Terephthalate. It's a strong, durable material constructed from 80% recycled plastic bottles.



CODE	SIZE (inches)	CASE PACK
21081035R	8 x 4 x 10 x 4	100
21141635R	14 x 6 x 16 x 6	100

DIGITAL PRINT
100+ \$2.25 each
1000+ \$1.99 each
300 bags minimum

FOIL PRINT
100+ 32¢ each
1000+ 29¢ each
2500+ 24¢ each

Please allow 2 - 3 weeks for printed items from approved art.

All print orders subject to set-up charges. Applicable artwork, and plate charges may apply. See page 122.

SPECIAL ORDER

Reusable Fabric Shoppers

IN STOCK

Reusable Shoppers

BAGS

BAGS



Top Turn Graphics Illustrate Recycled Bottle Content

Available Colors



15 - Black 08 - Grey 00 - White

Please allow 3 - 5 weeks for printed items from approved art.

New

Upcycle Laminated Totes

- RPET plus matte lamination
- W-fold bottom
- Eco-friendly, durable, recycled
- Small bag made of 2 water bottles - 140 gsm
- Medium bag made of 5 water bottles - 155 gsm
- Large bag made of 7 water bottles - 155 gsm



FOIL PRINT
75+ 32c each
1000+ 29c each
2500+ 24c each

CODE	DESCRIPTION	SIZE (inches)	CASE PACK
245905 __	Small	8 x 10 x 5.25	225
245906 __	Medium	12 x 14 x 7	150
245907 __	Large	18 x 14 x 7.5	75

Toronto Totes

CODE	DESCRIPTION	SIZE (inches)	CASE PACK
215909 __	Small Tote	9 x 5 x 12 x 5	100
215916 __	Large Tote	16 x 6 x 14 x 6	100



FOIL PRINT*
100+ 32c each
1000+ 29c each
2500+ 24c each



DIGITAL PRINT
100+ \$2.25 each
1000+ \$1.99 each
300 bags minimum



15 - Black with White
00 - White with Black

* Only Gold, Silver, White and Black foil is available for printing..

Please allow 3 - 5 weeks for printed items from approved art.



CODE	DESCRIPTION	SIZE (inches)	CASE PACK
A 21141600S	Four Seasons Tote	14 x 4 x 16 x 4	100
B 21141629	Two-tone Non-woven Tote	14 x 6 x 16 x 6	100
C 21141615B	Black Tote with 4" gusset	14 x 4 x 16 x 4	100
D 21111315BW	Six Bottle Wine Tote	11.5 x 7.25 x 13 x 7.25	100
E 21141655B	Black Tote with 8" gusset	14 x 8 x 16 x 8	100
F 21141609R	Red Tote with 8" gusset	14 x 8 x 16 x 8	100
G 21141675C	Large Kraft Composite Tote	14 x 6 x 16 x 6	100
H 21081075C	Small Kraft Composite Tote	8 x 4 x 10 x 4	100



DIGITAL PRINT
100+ \$2.25 each
1000+ \$1.99 each
300 bags minimum



FOIL PRINT
100+ 32c each
1000+ 29c each
2500+ 24c each



SCREEN PRINT
100+ 86c each
500+ 65c each
1000+ 54c each

Estimated lead time:
2 - 3 weeks for printed items from approved art.

IN STOCK

Non-Woven Garment Covers

Great for resale or promotions!

CODE	SIZE (inches)	CASE PACK
A 21244015	24 x 42	100
B 21245415	24 x 54	100
C 21247215	24 x 72 + 4	100

Silk screen set-up charge: \$65.00

Please allow 2-3 weeks for printed items from approved art.



SCREEN PRINT
 100+ 86¢ each
 500+ 65¢ each
 1000+ 54¢ each



BOXES

GIFT AND APPAREL



SPECIAL ORDER - Poly Garment Covers on Rolls

Please allow 6 - 8 weeks from approved art for delivery. Minimum 5 rolls per size. Plate costs apply.

CODE	DESCRIPTION	SIZE (inches)
212140 __	Suit 450/roll	21 x 3 x 40
212154 __	Coat 333/roll	21 x 3 x 54
212173 __	Dress 250/roll	21 x 3 x 72

Pricing includes printing on one side with one color.



In Stock
 One roll, white with no print for special price. Enquire within.
 21214000S, 21215400S, 21217300S

Colors available: White 00, Black 15, Ivory 16, Beige 39, Navy 11, Green 10. 1.0 mil LDPE. Minimum 5 rolls, printed or plain.

Print colors available: Black, Blue, Brown, Burgundy, Red, Green, Orange, Yellow and Metallic print

CREATE

YOUR OWN LOOK

Non-Woven Garment Covers

Custom Colors Available

SIZE	DESCRIPTION
24 x 42	Suit Bag
24 x 54	Coat Bag
24 x 72 + 4	Gown - Black

Please allow 14 - 16 weeks from approved art for delivery. Minimum 1000 per size.

Pricing includes printing on one side with one color.



All print orders subject to set-up charges. Applicable artwork, and plate charges may apply. See page 122.

SPECIAL ORDER

IN STOCK

Malibu Magnetic Closure Gift Box

Dual purpose - great for gifting and use after.
Perfect for e-commerce business subscriptions.

- Smooth paper covering
- Magnetic closures
- Three colors and three sizes
- Inserts available via special order. Ask your representative

CODE	DESCRIPTION	SIZE (in)	CASE PACK
454103 __	Small	8.5 x 2.75 x 1.625	100
454104 __	Medium	7.25 x 5.5 x 1.375	60
454116 __	Large	10.75 x 7.125 x 1.625	40



Please allow 3-5 weeks for printed items from approved art.



FOIL PRINT
Exterior and interior lid
40/60/100+ 32¢ each
1000+ 29¢ each
2500+ 24¢ each

Tuckit® Folding Gift Boxes

- One piece boxes fold and tuck together for a solid bottom
- 15 sizes available
- 100% recycled content (min. 35% post consumer) - kraft excluded

CODE	SIZE (inches)	CASE PACK
# 334103 __	3 x 3 x 2	100
# 334180 __	3 x 3 x 3	100
334111 __	4 x 4 x 4	100
334115 __	6 x 4.5 x 4.5	100
334113 __	6 x 6 x 4	100
334114 __	6 x 6 x 6	100
334120 __	8 x 8 x 3.5	100
• 334121 __	8 x 8 x 6	50
334119 __	9 x 4.5 x 4.5	100
# 334183 __	10 x 5 x 4	100
334124 __	10 x 10 x 6	50
+ 334131 __	12 x 6 x 6	50
+ 334125 __	12 x 12 x 2.5	50
# 334136 __	12 x 12 x 5.5	50
334186 __	14 x 6 x 6	50

- # only available in 12P-Kraft Pinstripe and 00-Econo white
- only available in 00-Econo White
- + not available in black gloss

100% recycled content (min. 35% post consumer) - kraft excluded



Bottom tucks into place for a secure fit.



FOIL PRINT
50/100+ 32¢ each
1000+ 29¢ each
2500+ 24¢ each

Please allow 3 - 5 weeks for printed items from approved art.



White Foldings

- Our most economical option ships flat and stores flat
- Please allow 2 - 3 weeks for printed items from approved art

Please allow 2 - 3 weeks for printed items from approved art.



FOIL PRINT
50/100+ 32¢ each
1000+ 29¢ each
2500+ 24¢ each



INK PRINT
50/100+ 31¢ each
1000+ 26¢ each
2500+ 22¢ each

CODE	DESCRIPTION	SIZE (inches)	CASE PACK
32058003 G58	Baby Mugs	3.5 x 3.5 x 2	100
32001003 G1	Mugs	4 x 4 x 4	100
32002003 G2	Cups and Saucers	6 x 6 x 4	100
32043003 G43	Bowls, etc.	10 x 8 x 4	100
32033003 G33	Bowls, etc.	10 x 10 x 6	100
32005003 G5	Teapots, etc.	8 x 8 x 5	100
32006003 G6	Teapots, etc.	8 x 8 x 8	100
32048003 G48	Fork, Knife, Spoon	13 x 4 x 2	100
32036003 G36	Casseroles	11 x 11 x 4.5	50
32013003 G13	Plates	5 x 5 x 2	100
32004003 G4	Plates	8 x 8 x 2	100
32008003 G8	Plates	11 x 11 x 2	100
32009003 G9	Plates	13.5 x 13.5 x 2	100
32040003 G40	Plates	15 x 15 x 2	100
32003003 G3	All purpose	7 x 4 x 3	100
32010003 G10	All purpose	9 x 4.5 x 4.5	100
32038003 G38	All purpose	12 x 4 x 4	100
32041003 G41	All purpose	10 x 7 x 7	100
32224003 G24*	2-Piece Boxes - Base	6 x 6 x 10	100
32124003 G24*	2-Piece Boxes - Lid		100

* Must be ordered together.

Apparel Boxes

Seven sizes and four colors to choose from!

- Minimum order quantity is one case pack
- Please allow 2 - 3 weeks for printed in stock boxes from approved art

CODE	DESCRIPTION	SIZE (inches)	CASE PACK
A 32072 ___	Glove/Sock*	11.5 x 5.5 x 1.5	100
B 32073 ___	Lingerie/T-Shirt	11.5 x 8.5 x 1.625	100
C 32075 ___	Shirt	15 x 9.5 x 2	100
D 32076 ___	Sweater/Dress	17 x 11 x 2.5	50
E 32077 ___	Jacket/Robe	19 x 12 x 3	50
F 32078 ___	Coat/Gown	24 x 14 x 4	25
G 32071 ___	Sweater (white only) (not shown)	15 x 11 x 4.5	50

* Kraft pinstripe/White only



FOIL PRINT
25/50/100+ 32¢ each
1000+ 29¢ each
2500+ 24¢ each



INK PRINT
25/50/100+ 31¢ each
1000+ 26¢ each
2500+ 22¢ each

For Special Order please allow 3-5 weeks for printed boxes from approved art.



IN STOCK COLORS



SPECIAL ORDER COLOR

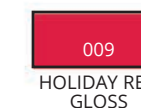

CREATE YOUR OWN LOOK

E-Commerce



CREATE YOUR OWN LOOK

Eco-Friendly, Recyclable
E-Commerce Packaging



Custom E-Commerce Gift Boxes

Go above and beyond to impress customers and exceed their expectations by delivering more than just a product, but also an experience.

- Please allow 12 - 14 weeks for printed items from approved art

SIZE (inches)

10 x 6 x 4
11.125 x 8.75 x 4
14.5 x 7.25 x 5
17 x 12 x 4.25
17.125 x 11.125 x 2

NO PLATE CHARGES!



Create Your Own Look:
Choose your box style.
Send us your artwork.
For 100% full color design, speak to your sales representative.

Custom Poly Mailers

- 2.0 mil co-extruded LDPE film
- White exterior with black interior
- 2" adhesive lip
- Plate charges apply
- Please allow 12 - 14 weeks for printed items from approved art

SIZE (inches)

9 x 12 + 2
12 x 15 1/2 + 2
14 1/2 x 19 + 2
19 x 24 + 2

OTHER TYPES OF MAILERS AVAILABLE:

Product Description	Minimum Qty
Recycled Poly Mailers	25,000+
Padded Paper Mailers	40,000+
Paper Apparel Mailers	10,000+
Rigid Paper Mailers	10,000+
Bubble Poly Mailers	25,000+



50% Recycled Shell
Made in the US

Ask Your Representative For Details On Personalizing Your E-Commerce Mailers

10,000 minimum
1, 2 or 4 color process. One or both sides

IN STOCK

Deliver the 'in-store' experience to your customer's door.



Gift and Apparel Ecommerce

- Reversible kraft with oyster or black interior
- Study E Flute for safe delivery in 3 sizes
- Pack flat with 50 pieces/carton

CODE	SIZE (inches)	CASE PACK
451009 ___	10.25 x 9.062 x 4.375	50
451511 ___	15.562 x 11.062 x 4.562	50
451612 ___	16.937 x 12.625 x 6.5	50



INK PRINT
50+ 31¢ each
1000+ 26¢ each
2500+ 22¢ each



FOIL PRINT
50+ 32¢ each
1000+ 29¢ each
2500+ 24¢ each



15B - Black
87B - Metallic Bronze



FOIL PRINT
25+ 32¢ each
1000+ 29¢ each
2500+ 24¢ each

Please allow 2 - 3 weeks for printed items from approved art.

* Inserts can be special ordered to fit any of our other jewelry packaging collections. Contact your sales representative for a quote.
Minimum order: 100 per size

Jewelry Boxes

For Geo, Velocity and Horizon packaging.

- Reversible kraft boxes with black or metallic bronze interior
- Black flock inserts available to fit Gold Galleria, Horizon, Geo or Velocity jewelry packaging*
- Minimum case pack 25

CODE	DESCRIPTION	SIZE (inches)
450505 ___	Small Ecom Box	5.75 x 5.75 x 2.5
451010 ___	Large Ecom Box	10.25 x 10.25 x 2.5
Gold Galleria/Horizon Inserts		
69221003H	Ring to fit small box	
69622003H	T-pad to fit small box	
69684003H	Utility to fit small box	
69693003H	Bracelet to fit large box	
69673003H	Necklace to fit large box	
Geo Inserts		
69221153G	Ring to fit small box	
69283153G	T-pad to fit small box	
69293153G	Bracelet to fit large box	
69273153G	Necklace to fit large box	
Velocity Inserts		
69321153V	Ring to fit small box	
69383153V	Utility pad to fit small box	
69393153V	Bracelet to fit large box	
69373153V	Necklace to fit large box	

All print orders subject to set-up charges. Applicable artwork, and plate charges may apply. See page 122.

IN STOCK

Recyclable Ecommerce Mailer

- Natural brown kraft paper
- 150 gsm recycled paper - 40% PCW
- Strong and flexible with 3" gussets
- 1 sku - customizable to sizes



CODE	SIZE (inches)	CASE PACK
52524512	20.5 x 3 x 17.75	200

FOIL PRINT		
200+	32c each	
1000+	29c each	
2500+	24c each	

ECO-FRIENDLY – “BE PROUD OF THE WAY YOU SHIP”



A Recycled Poly Mailers

- IN STOCK -

CODE	SIZE (inches)	CASE
52091286	9 x 12	1000
52101386	10 x 13	1000
52121586	12 x 15.5	500

- SPECIAL ORDER -

CODE	SIZE (inches)	CASE
52060986	6 x 9	1000
52071086	7.5 x 10.5	1000
52141986	14.5 x 19	250
52192486	19 x 24	125
52242486	24 x 24	125

B Padded Paper Mailers

- IN STOCK -

CODE	SIZE (inches)	CASE
52060976	6 x 9	250
52081176	8.5 x 11	100

- SPECIAL ORDER -

CODE	SIZE (inches)	CASE
52101576	10.5 x 15	100

C Paper Apparel Mailers

- IN STOCK -

CODE	SIZE (inches)	CASE
52101375	10 x 13	250
52121575	12 x 15.5	150
52101975	10.5 x 4 x 19	100

- SPECIAL ORDER -

CODE	SIZE (inches)	CASE
52070975	7 x 9	250

D Rigid Paper Mailers

- IN STOCK -

CODE	SIZE (inches)	CASE
52061012	6 x 10	500
52061212	6 x 2.5 x 12	500
52091412	9.5 x 14.5	250

- SPECIAL ORDER -

CODE	SIZE (inches)	CASE
52081212	8.5 x 12	250
52101612	10.5 x 16	250
52121912	12.5 x 19	250

E Bubble Poly Mailers

NO PRINT

- SPECIAL ORDER -

CODE	SIZE (inches)	CASE
52040600	4 x 6.75	500
52060800	6.5 x 8.75	250
52081000	8.5 x 10.75	100

Custom printing available.
Minimum 25,000 quantities.



100% Recycled Shell
Made in the US



FOIL PRINT
100+ 32c each
1000+ 29c each
2500+ 24c each



PAD PRINT
100+ 32c each
1000+ 29c each
2500+ 24c each



INK PRINT
100+ 31c each
1000+ 26c each
2500+ 22c each

For more product information on recyclability and material content, visit gunthermele.com

FINISHING TOUCHES

RIBBON, TISSUE, WRAP AND SEALS



All print orders subject to set-up charges. Applicable artwork, and plate charges may apply. See page 122.

IN STOCK

Inspirations Gift Wrap

Inspirations
Giftwrap

By Gunther Mele

Available for immediate shipment.



Inspirations
Giftwrap

By Gunther Mele

Available for immediate shipment.



IN STOCK

Inspirations Gift Wrap

GIFT WRAP

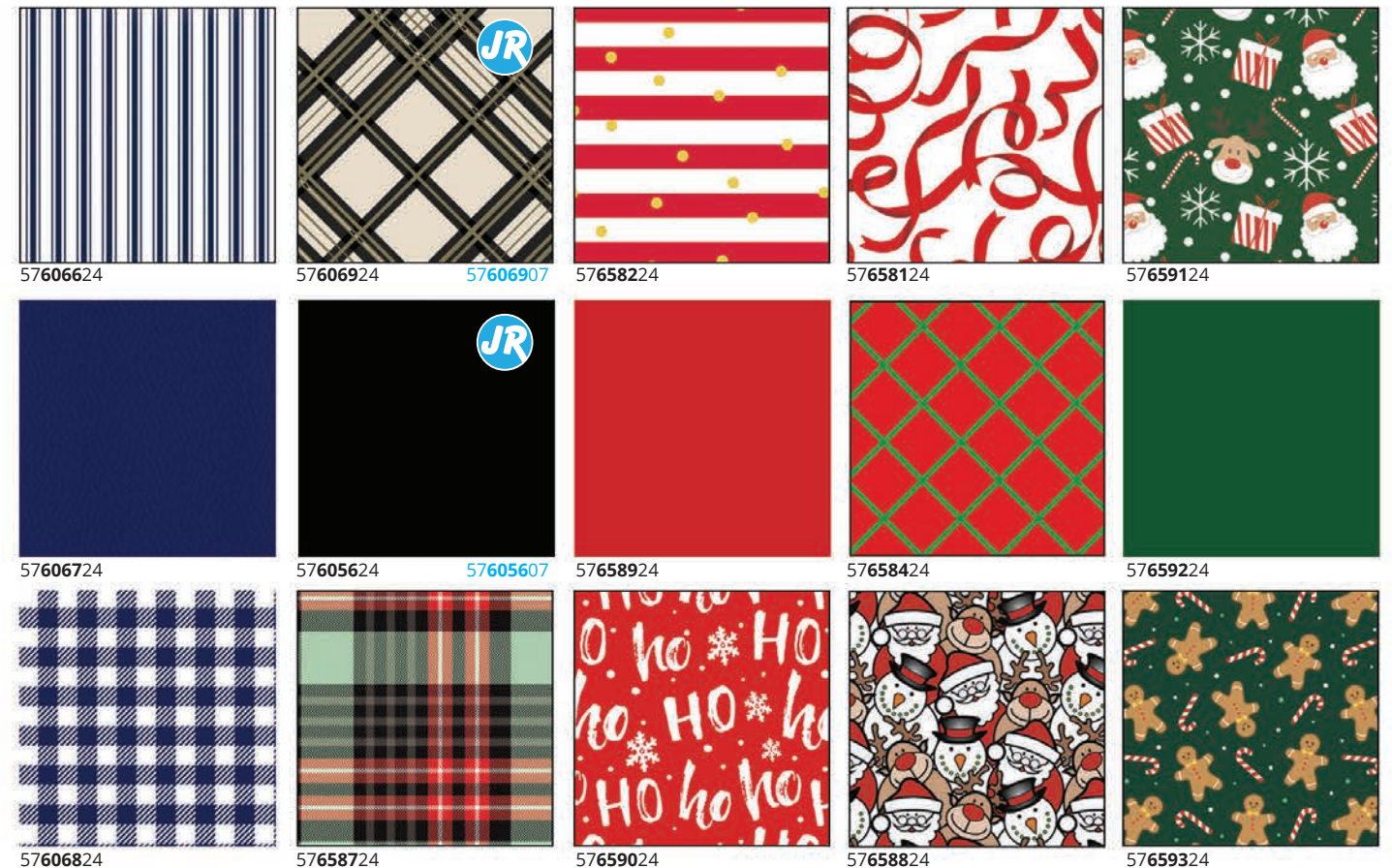
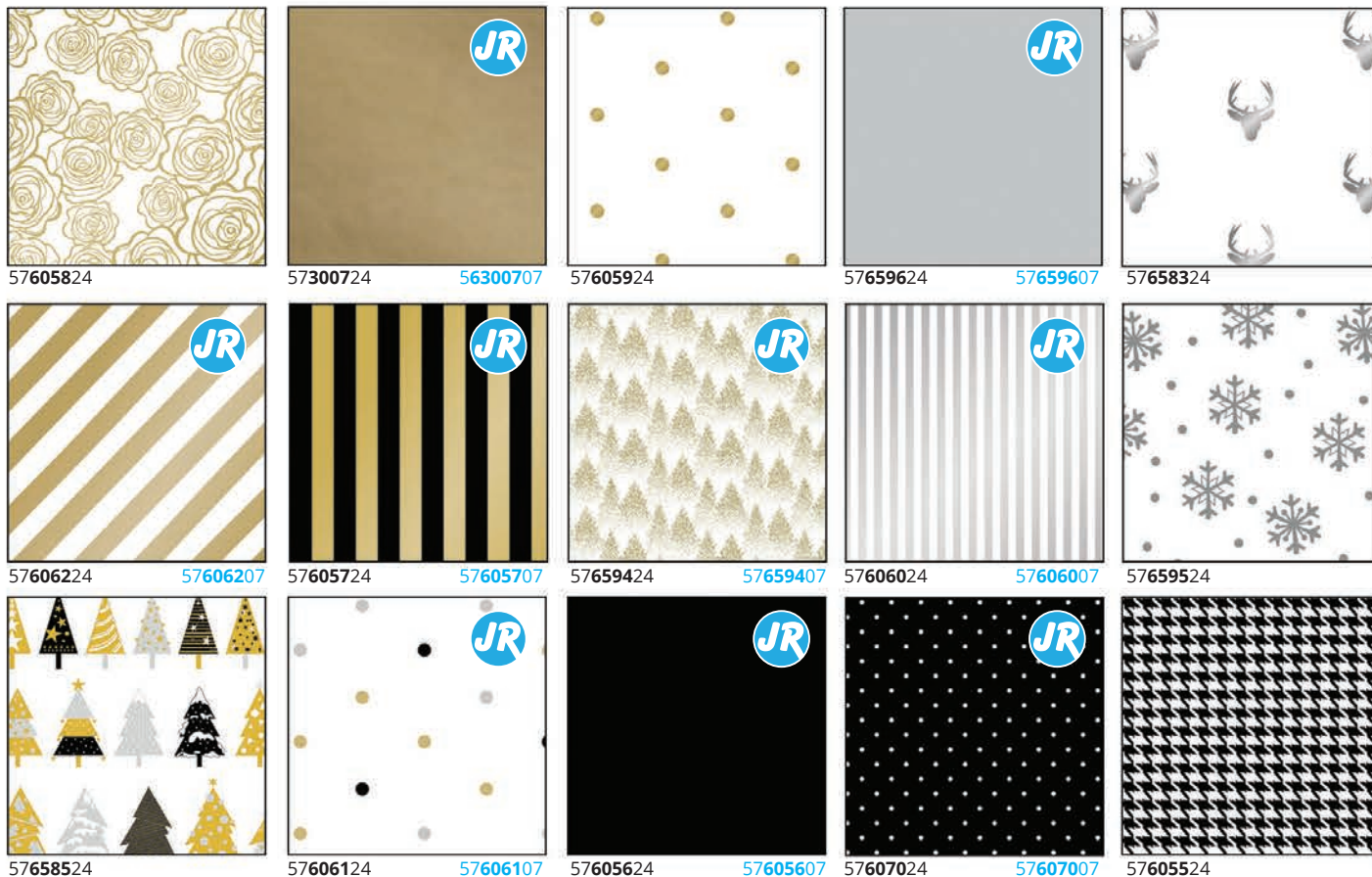

24" x 417' - 1/2 Ream Roll
\$95.00 each Code # 57 ____ 24

8" x 150' - Jewellers Rolls **\$39.00** each Code # 57 ____ 07

24" x 417' - 1/2 Ream Roll
\$95.00 each Code # 57 ____ 24

8" x 150' - Jewellers Rolls **\$39.00** each Code # 57 ____ 07

SPECIAL ORDER

Sullivan Designs Seasonal

Please allow 4 - 6 weeks for shipment.



SPECIAL ORDER

Sullivan Designs Every Day

Please allow 4 - 6 weeks for shipment.

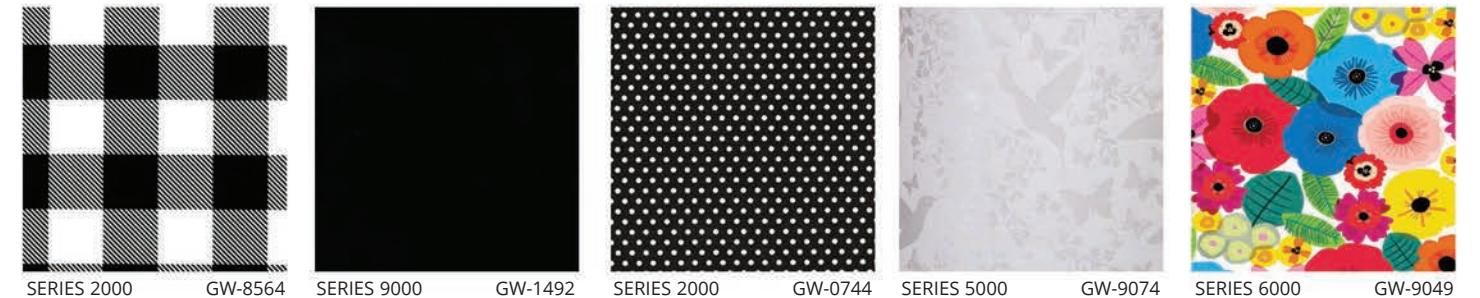

Additional custom order designs available to choose from. Contact your area sales representative for more info.

SULLIVAN designs available in 1/2 Ream Rolls and Full Ream Rolls

NOTE: All Sullivan gift wrap orders must include GW design code.

MINIMUM ORDER: 1 Roll per design (15" rolls must be ordered in multiples of 2 rolls per design)

SLITTING CHARGE: A slitting charge of \$25.00 applies to each individual roll. No more than two slits per roll; (2 slits = \$25.00)

Pricing Level	15H	24H	30H	15F	24F	30F
	Half Ream 15" x 417"	Half Ream 24" x 417"	Half Ream 30" x 417"	Full Ream 15" x 833"	Full Ream 24" x 833"	Full Ream 30" x 833"
2000 Series	\$115.65	\$172.84	\$199.54	\$193.18	\$310.11	\$364.76
5000 Series	\$132.18	\$199.54	\$228.77	\$224.96	\$362.22	\$425.77
6000 Series	\$156.32	\$238.94	\$274.53	\$268.17	\$439.75	\$514.73
9000 Series	\$177.94	\$282.15	\$322.82	\$320.28	\$526.17	\$613.87
9500 Series	\$216.06	\$312.65	\$362.22	\$358.40	\$589.72	\$695.04

View our entire Selection online at GUNTHERMELE.COM

Jewelers Rolls

Size: 7.375" x 150'

\$64.90/roll

Minimum order 1 roll.
JRX150 - Jeweller Roll suffix code.

Counter Rolls

Size: 24" x 100'

\$75.90/roll

Minimum order 1 roll.
-24X100 - Counter Roll suffix code.
Note: Sullivan does not allow counter roll slitting.

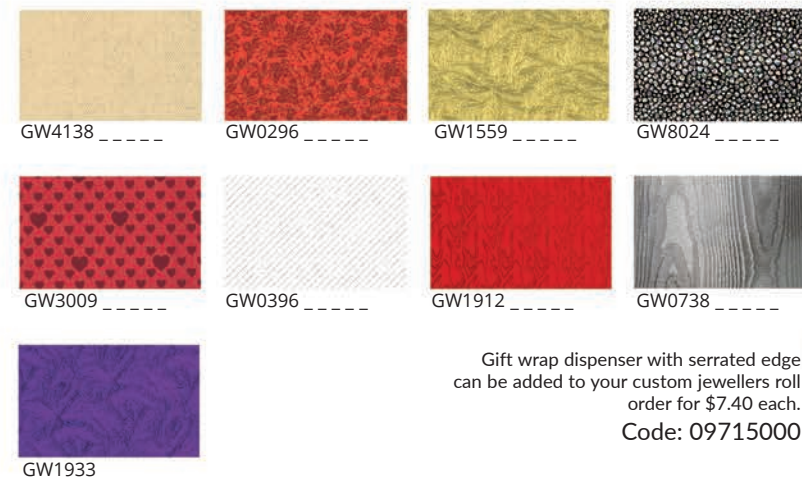

Gift wrap dispenser with serrated edge can be added to your custom jewellers roll order for \$7.40 each.
Code: 09715000



SPECIAL ORDER

Shamrock Designs Seasonal

Please allow 4 - 6 weeks for shipment.



SPECIAL ORDER

Shamrock Designs Every Day

Please allow 4 - 6 weeks for shipment.

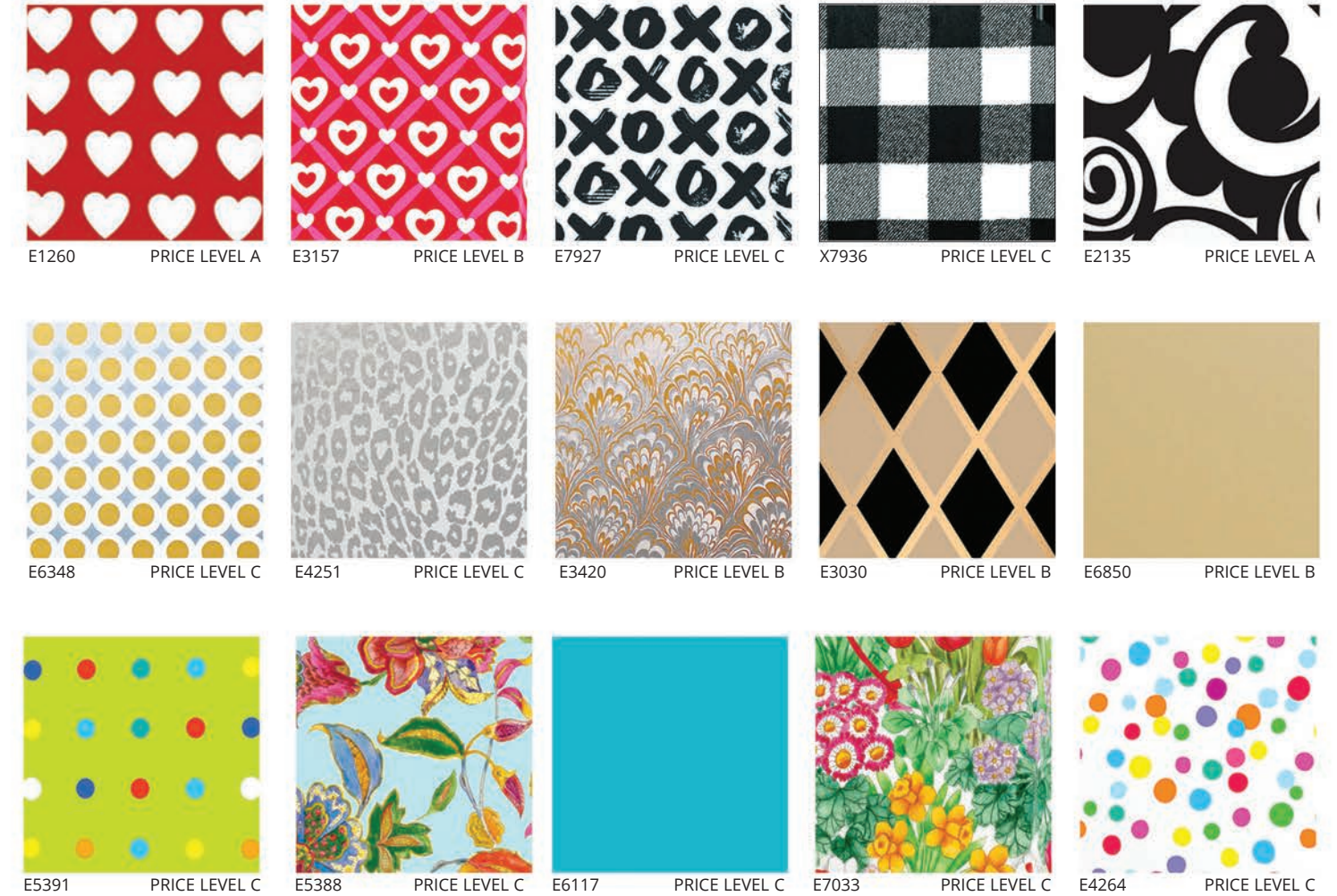

Additional custom order designs available to choose from. Contact your area sales representative for more info.

Shamrock designs available in Cutter Boxes, 1/2 Ream Rolls and Full Ream Rolls

View our entire
Selection online at
GUNTHERMELE.COM

NOTE: All Shamrock gift wrap orders must include design code.

MINIMUM ORDER: 1 Roll

Jewellers Rolls also available. Most are minimum 3 rolls per design.*

SLITTING CHARGE: A slitting charge of \$25.00 applies to each individual roll. (no more than two slits per roll - 2 slits = \$25.00)

Contact your sales representative for details.* Select designs available in 1 roll minimums.

Pricing Level	7J	24C	18H	24H	30H	36H	18F	24F	30F	36F
	Jewellers Roll 7.375"x100'	Cutter Box 24" x 100'	Half Ream 18" x 417'	Half Ream 24" x 417'	Half Ream 30" x 417'	Half Ream 36" x 417'	Full Ream 18" x 833'	Full Ream 24" x 833'	Full Ream 30" x 833'	Full Ream 36" x 833'
A	\$20.12	\$40.12	\$127.43	\$115.64	\$191.15	\$191.15	\$207.66	\$195.87	\$323.30	\$323.30
B	\$24.82	\$49.56	\$158.11	\$146.31	\$240.70	\$240.70	\$271.38	\$259.58	\$429.48	\$429.48
C	\$29.56	\$59.00	\$181.71	\$169.91	\$280.82	—	\$316.21	\$304.42	\$502.64	—
D	\$31.92	\$63.72	\$195.87	\$184.06	—	—	\$346.90	\$335.09	—	—
E	\$54.28	\$108.55	\$297.33	\$285.54	—	—	\$547.47	\$535.68	—	—

CREATE YOUR OWN LOOK

• Please allow 6 - 8 weeks for printed items from approved art.



Printed Tissue: Pick a PMS print color and we will match it.

– See page 105 for Special Order Tissue Colors!

CODE	DESCRIPTION	SIZE (in)	PACKAGED	PRICE/EACH	
				10 REAMS	30 REAMS
20869000G	White	20 X 30	480	\$73.60	\$69.00
20869000M	Colored	20 x 30	480	\$102.35	\$93.15
20869000GK	Kraft	20 x 30	480	\$73.60	\$69.00
20869001M	Metallic SS*	20 x 30	200	\$136.90	\$109.52

* SS - single sided

Print included in price of tissue.

Minimum 10 reams. Note: Plates extra \$275.00 (per color).
Ships in approximately 6 - 8 weeks.

For metallic ink print: add 10% to the price above.
For > 50% ink coverage, an additional \$10 per ream.
All custom orders subject to a +/-10% over/under run.

Custom Printed
White Tissue –
10 Reams \$736.00

IN STOCK

Available for immediate shipment.

Spotlight Tissue Colors

CODE	DESCRIPTION	SIZE (in)	PKG	PRICE/EACH		
				1 - 4	5+	25+
20819290S	White Economy	19 x 29	480	\$18.55	\$17.00	\$15.45
208551_G	Spotlight on Value (colors)	20 x 30	480	\$48.77	\$46.82	\$44.60
208559_G	Spotlight on Value (metallic)	20 x 30	200	\$60.72	\$57.60	\$55.80
20850102	#1 White Economy	19 x 14.5	480	\$9.64	\$8.75	\$7.19
20851800	#1 White Bleached	18 x 9 dia.	1 roll	\$108.59/roll		
20852000	#1 White Bleached	20 x 9 dia.	1 roll	\$116.35/roll		

12 in stock tissue colors to choose from. Plus check out our assorted Pre-Packs!



Spring Assortment Pre-Pack

20855100G - 20 x 30" - \$48.77/Pack

Contains 100 of each:

Green, Lemon, Tangerine, Pink, Blue.

10 FOREST GREEN	14 DANDELION	16 ORANGE	19 BRIGHT LIME	56 ZIPPY GRAPE	21 HOT PINK	07 GOLD
60 EMERALD	66 BURGUNDY	81 ROYAL BLUE				08 SILVER

SPECIAL ORDER

Unprinted Tissue

Unprinted, minimum 1 ream (per color).
Ships in approximately 4 - 6 weeks.

CODE	DESCRIPTION	SIZE (in)	Packaged	PRICE/REAM	
				1 REAM	25+ REAMS
20899_--	Special Order Colors	20 x 30	480 sheets	\$39.90	\$37.10

NE-100 LIGHT PINK	NE-110 PINK	NE-120 CORAL ROSE	NE-124 AZALEA	NE-126 SCARLET	NE-130 RED	NE-131 DEEP SCARLET	NE-145 FUCHSIA	NE-148 HOT PINK	NE-150 CERISE	NE-155 ZIPPY GRAPE
NE-160 PURPLE	NE-164 SANDSTONE	NE-165 BURGUNDY	NE-170 DUBONNET	NE-190 PEACH	NE-195 TANGERINE	NE-200 ORANGE	NE-210 LIGHT YELLOW	NE-220 YELLOW	NE-222 DANDELION	NE-223 OATMEAL
NE-226 POPPY	NE-230 GOLDENROD	NE-235 PISTACHIO	NE-246 EMERALD	NE-247 JADE	NE-245 PALE MINT	NE-250 MID GREEN	NE-251 GROOVY GREEN	NE-255 BRIGHT LIME	NE-265 TEAL	NE-266 BALSAM
NE-269 OASIS GREEN	NE-270 DARK GREEN	NE-273 FESTIVE GREEN	NE-274 CEDAR GREEN	NE-275 FOREST GREEN	NE-277 TAPESTRY GREEN	NE-278 AZURE	NE-279 OXFORD BLUE	NE-281 BLUE BREEZE	NE-300 TURQUOISE	NE-305 CERULEAN
NE-306 BRILLIANT BLUE	NE-308 SAPPHIRE	NE-310 DARK BLUE	NE-325 LILAC	NE-330 LAVENDER	NE-335 PERIWINKLE	NE-338 LILAC PERFUME	NE-340 PLUM	NE-341 RASPBERRY FIZ	NE-345 CRANBERRY	NE-347 CRÈME
NE-350 FRENCH VANILLA	NE-354 SHADOW GREY	NE-356 GRANITE	NE-357 NOBLE GOLD	NE-359 ESPRESSO	NE-360 DESERT TAN	NE-361 BERMUDA SAND	NE-362 TERRA COTTA	NE-366 BURNT SIENNA	NE-370 CHOCOLATE	NE-371 RAW SIENNA
NE-375 ANTIQUUE BLUE	NE-382 COLONIAL BLUE	NE-385 NAVY BLUE	NE-386 MORNING MIST	NE-389 MOUNTAIN MIST	NE-390 GRAY	NE-400 BLACK	NE-410 BIRCH	NE-415 DUNE BEIGE	NE-417 PARCHMENT	

All print orders subject to set-up charges. Applicable artwork, and plate charges may apply. See page 122.

IN STOCK

Available for immediate shipment.

Curling Ribbon

See chart for available colors

CODE	PRICE/ROLL
COLORS - 3/16" x 500 yards 148373 __	\$3.35
METALLIC - 3/16" x 250 yards 148378 __	\$10.07



2.75" Star Bows

See chart for available colors

CODE	CASE PACK	PRICE/EACH 100+	1000+
COLORS - 2.75" x 17 loop 142311 __	200	\$0.10	\$0.09
METALLIC - 2.5" x 17 loop 14531107 Gold	200	\$0.11	\$0.10
14531108 Silver	200	\$0.11	\$0.10

Min: case pack



3.75" Star Bows

See chart for available colors

CODE	CASE PACK	PRICE/EACH 100+	1000+
COLORS - 3.75" x 13 loop 143512 __	200	\$0.12	\$0.11
METALLIC - 3.75" x 17 loop 14551207 Gold	200	\$0.19	\$0.16
14551208 Silver	200	\$0.19	\$0.16

Min: case pack

Splendor Ribbon

See chart for available colors

CODE	PRICE/ROLL
COLORS - 3/4" x 250 yards 141050 __	\$10.35
METALLIC - 3/4" x 100 yards 14013007 Gold	\$14.11
14013008 Silver	\$14.11

Color # Name	Curling Ribbon	2.75" Star Bows	3.75" Star Bows	Splendor Ribbon
00 - White				
86 - Ivory				
29 - Vanilla				
61 - Pastel Yellow				
03 - Yellow				
13 - Daffodil				
14 - Sunshine Yellow				
07 - Gold				
08 - Silver				
27 - Holiday Gold				
22 - Melon				
73 - Coral				
16 - Tropical Orange				
17 - Orange				
12 - Chocolate				
75 - Baby Pink				
01 - Pink				
80 - Primrose				
57 - Azalea				
09 - Red				
58 - Lava Red				
66 - Burgundy				
41 - Beauty				
59 - Dubonnet Rose				
28 - Orchid				
05 - Lavender				
56 - Purple				
54 - Periwinkle				

Color # Name	Curling Ribbon	2.75" Star Bows	3.75" Star Bows	Splendor Ribbon
50 - Plum				
11 - Royal				
81 - Navy				
77 - Baby Blue				
02 - Light Blue				
47 - Aqua				
32 - Caribbean Blue				
55 - Robin's Egg				
25 - Turquoise				
71 - Sea Green				
18 - Celery				
74 - Spruce				
60 - Hunter				
84 - Teal				
04 - Mint				
19 - Citrus				
96 - Leaf				
30 - Celadon				
10 - Emerald				
70 - Antique Silver				
15 - Black				
07 - Metallic Gold				
08 - Metallic Silver				
09 - Metallic Red				
10 - Metallic Green				
99 - Everyday Assortment	N/A			N/A
98 - Christmas Assortment	N/A			N/A



99 - Everyday Assortment Star Bows Available in 2.75" and 3.75"



98 - Christmas Assortment Star Bows Available in 2.75" and 3.75"



Metallic Star Bows Available in 2.75" and 3.75"

IN STOCK

Available for immediate shipment.

Perfect Bows™

Minimum: 50 per size, per color.

CODE	SIZE	PRICE/EACH	
		50+	1000+
140515 __	5.5" Perfect Bow	\$0.59	\$0.54



Pull Bows

Minimum: 100 per size, per color.

CODE	SIZE	STANDARD COLORS		METALLIC COLORS	
		100+	1000+	100+	1000+
132000 __	Petite 2" Bows	\$0.21	\$0.18	\$0.33	\$0.30
134000 __	Std. 4" Bows	\$0.34	\$0.32	\$0.56	\$0.53



Mini Metallic Star Bows

252 per tub

CODE	DESCRIPTION	PRICE/TUB
14121099	Assorted	\$35.53
14121017	Gold	\$35.53
14121008	Silver	\$35.53



Matte Wraphia™

CODE	SIZE	PRICE/ROLL
148367 __	100 yds	\$8.40

Paper Roll/Ream Dispenser and Tape

CODE	DESCRIPTION	PRICE
09850124	Paper Roll/Ream Roll dispenser - 24" rack	\$67.00 each
09725000	Transparent Tape 1/2" x 66 m	\$29.00/box of 12 Min. order: 1 box



Cellophane (1.0mil)

CODE	DESCRIPTION	SIZE	PRICE/ROLL
16400506	Clear Cellophane	40" x 100'	\$10.50
16300506	Clear Cellophane	40" x 300'	\$23.90

Ribbon Shredder

CODE: 09878600
PRICE: \$6.99 each



Curling Ribbon Roll Dispenser

CODE: 09850100
PRICE: \$134.00 each



Holds 12 Rolls

SPECIAL ORDER

SPECIAL ORDER

RIBBON

RIBBON

Printed Satin Ribbon

See chart to the right for ribbon colors.

Single Face Satin

WIDTH	CODE	PRICE/EA
3/8" x 100 yd roll	14150002	\$51.70
5/8" x 100 yd roll	14150003	\$53.90
7/8" x 100 yd roll	14150005	\$66.00
1-1/2" x 100 yd roll (2 x 50 yd rolls)	14150015	\$79.20

500 yard minimum per width. Note: Plates extra \$77.00 (per color).



Contact your sales representative.



5/8" Single Face Satin Ribbon with Foil Print

Foil Print Colors

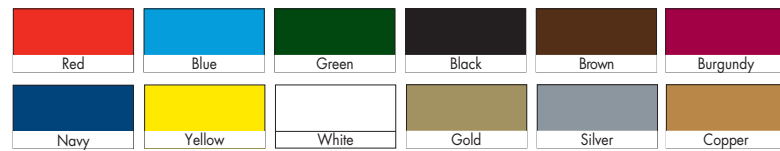

FOIL PRINT
Included in price of ribbon

Please allow 3 -4 weeks for printed items from approved art.

Unprinted Satin and Grosgrain Ribbon

Lead time please allow 4 -6 weeks for shipment. SPECIAL ORDER

See chart to the right for ribbon colors.

Single Face Satin

WIDTH	CODE	PRICE/EA
3/8" x 100 yd roll	14031 ___	\$18.90
5/8" x 100 yd roll	14032 ___	\$19.55
7/8" x 100 yd roll	14033 ___	\$35.21
1-1/2" x 50 yd roll	14034 ___	\$19.55

1 roll minimum.

Grosgrain

WIDTH	CODE	PRICE/EA
3/8" x 100 yd roll	14160 ___	\$18.90
5/8" x 100 yd roll	14161 ___	\$19.01
7/8" x 100 yd roll	14162 ___	\$34.23
1-1/2" x 50 yd roll	14170 ___	\$18.10

While we strive for accuracy in our catalog, actual product may be slightly different than pictured.

Please allow 3 -4 weeks for printed items from approved art.

3/8"		5/8"		7/8"		1-1/2"		COLOR NUMBER AND NAME	3/8"		5/8"		7/8"		1-1/2"		COLOR NUMBER AND NAME
Single Face Satin	Grosgrain	Single Face Satin	Grosgrain	Single Face Satin	Grosgrain	Single Face Satin	Grosgrain		Single Face Satin	Grosgrain	Single Face Satin	Grosgrain	Single Face Satin	Grosgrain	Single Face Satin	Grosgrain	
								029 - White									462 - Royal Orchid
								007 - Shell Grey									464 - Delphinium
								012 - Silver									465 - Purple
								015 - Grey									470 - Regal Purple
								022 - Pewter									473 - Amethyst
								028 - Antique White									528 - Lemon Grass
								813 - Oyster									530 - Mint
								016 - Portobello									533 - Jungle Green
								030 - Black									547 - New Chartreuse
								115 - Powder Pink									548 - Kiwi
								117 - Light Pink									550 - Apple Green
								150 - Pink									558 - Leaf
								156 - Hot Pink									567 - Spring Moss
								175 - Shocking Pink									570 - Moss
								187 - Azalea									580 - Emerald
								241 - Living Coral									586 - New Neon Green
								250 - Red									587 - Forest Green
								252 - Hot Red									617 - Baby Maize
								260 - Scarlet									640 - Lemon
								275 - Wine									645 - Daffodil
								277 - Burgundy									650 - Maize
								285 - Plum									660 - Yellow Gold
								305 - Light Blue									675 - Gold
								331 - Dusty Blue									690 - Old Gold
								312 - Blue									722 - Burnt Sienna
								315 - Navajo Turquoise									743 - Ginger
								329 - Cobalt									750 - Torrid Orange
								340 - Turquoise									789 - Sherry
								343 - Tornado Blue									790 - Currant
								350 - Royal									810 - Ivory
								352 - Electric Blue									815 - Cream
								353 - Century Blue									825 - Natural
								365 - Light Navy									835 - Tan
								370 - Navy									841 - Khaki
								412 - Purple Haze									850 - Brown
								430 - Light Orchid									866 - Coffee
								450 - Orchid									

All print orders subject to set-up charges. Applicable artwork, and plate charges may apply. See page 122.

IN STOCK

In stock and ready to ship.

Simply Sheer Asiana Ribbon

Monofilament-Edge



CODE	SIZE	PRICE/ROLL
149435 __	7/8" x 100 yards	\$12.54
149436 __	1 1/2" x 100 yards	\$13.75

• minimum order: one roll.



Can be special ordered in additional colors!

SPECIAL ORDER

Please allow 4 - 6 weeks for shipment.

Contessa Ribbon

Wire-Edge Single Face Satin



CODE	SIZE	PRICE/ROLL
14163 ___	1 1/2" x 25 yards	\$14.00
*14164 ___	2 1/4" x 25 yards	\$21.00

• minimum order: one roll.



* 2-1/4" is only available in 029-White, 260-Scarlet, 643-Buttercream and Ivory (810).

Encore Ribbon

Wire-Edge



CODE	SIZE	PRICE/ROLL
141650 __	5/8" x 25 yards	\$6.83
141660 __	1 1/2" x 25 yards	\$13.66
141670 __	2 1/2" x 25 yards	\$20.44

• minimum order: one roll.

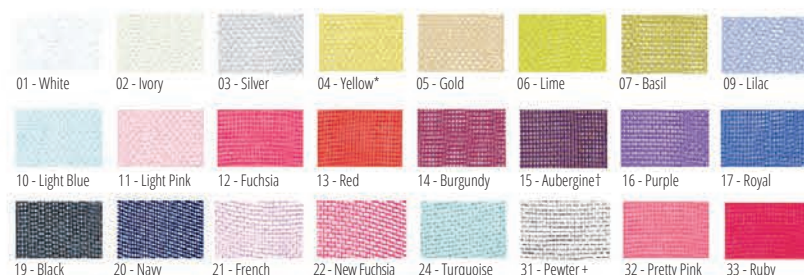

* not available in 5/8"
† not available in 2 1/2"

Garbo Ribbon



CODE	SIZE	PRICE/ROLL
14168 ___	5/8" x 100 yards	\$50.00
14169 ___	1 1/2" x 50 yards	\$38.66

• minimum order: one roll.



* not available in 5/8"
† not available in 1 1/2"



Please allow 4 - 6 weeks for printed items from approved art.

CREATE YOUR OWN LOOK

Raised Ink Printing

See chart below for ribbon colors.

Pick your own colors for raised print - NO PLATE CHARGE

WIDTH	PRICE EACH	Single Face Satin CODE	Grosgrain CODE	Sheer CODE
5/8" x 100 yd roll	\$44.00	14140039	14150042	14140045
7/8" x 100 yd roll	\$47.00	14140040	14150043	14140046
1-1/2" x 50 yd roll	\$83.00	14140041	14150044	14140047

40 roll minimum for all printed ribbon.

Sheer Ribbon Colors

All colors are available in all sizes. See page 115 for single face satin and grosgrain color availability.



Single Face Satin Ribbon with Raised Print



Sheer Ribbon with Raised Print



Grosgrain Ribbon with Raised Print

IN STOCK

IN STOCK

SEALS

SEALS



Customized Seals-Foil Printed

CODE	SIZE	One color foil print/each		SPECIAL ORDER Two color/each		SPECIAL ORDER Acetate 1 color/each		SPECIAL ORDER Acetate 2 color/each	
		2000+	5000+	2000+	5000+	2000+	5000+	2000+	5000+
25 4 digit label code 2 digit label color	A	\$0.0880	\$0.0820	\$0.1512	\$0.1188	\$0.1728	\$0.1350	\$0.1976	\$0.1533
	B	\$0.1000	\$0.0900	\$0.1620	\$0.1296	\$0.2074	\$0.1630	\$0.2376	\$0.1900
	C	\$0.1200	\$0.1100	\$0.1782	\$0.1447	\$0.2473	\$0.1901	\$0.2786	\$0.2268
	D*	\$0.1350	\$0.1200	\$0.1858	\$0.1544	\$0.3056	\$0.2451	\$0.3348	\$0.2635

\$80 plate charge

NO PLATE CHARGES

Label Colors Available:



* D sized Seals and Clear print are SPECIAL ORDER. See foil chart on inside back cover of catalog for available print colors.



FOIL PRINT
Included in the price. Please allow 2-3 weeks for printing.

Pre-printed Labels



CODE	SIZE	CASE	PRICE/EACH	
			1000+	5000+
25401007S	5/8 x 3/8"	1000	\$0.092	\$0.086
25401407S	5/8 x 3/8"	1000	\$0.092	\$0.086
25406208S	5/8 x 3/8"	1000	\$0.092	\$0.086
25401007V	3/4" oval	1000	\$0.092	\$0.086
25401407V	3/4" oval	1000	\$0.092	\$0.086
25406008V	3/4" oval	1000	\$0.092	\$0.086

1000/box minimum order - 1 box of 1000.

Available for immediate shipment.

For a no-print solution, order our in stock embossed seals.

Embossed Seals

500/box min. order - 1 box.

CODE	SIZE	PRICE/EA
Gold 08701207	1.5" dia.	\$0.0411
Silver 08701208	1.5" dia.	\$0.0411

ACTUAL EMBOSSED PATTERN 1.5" DIA.

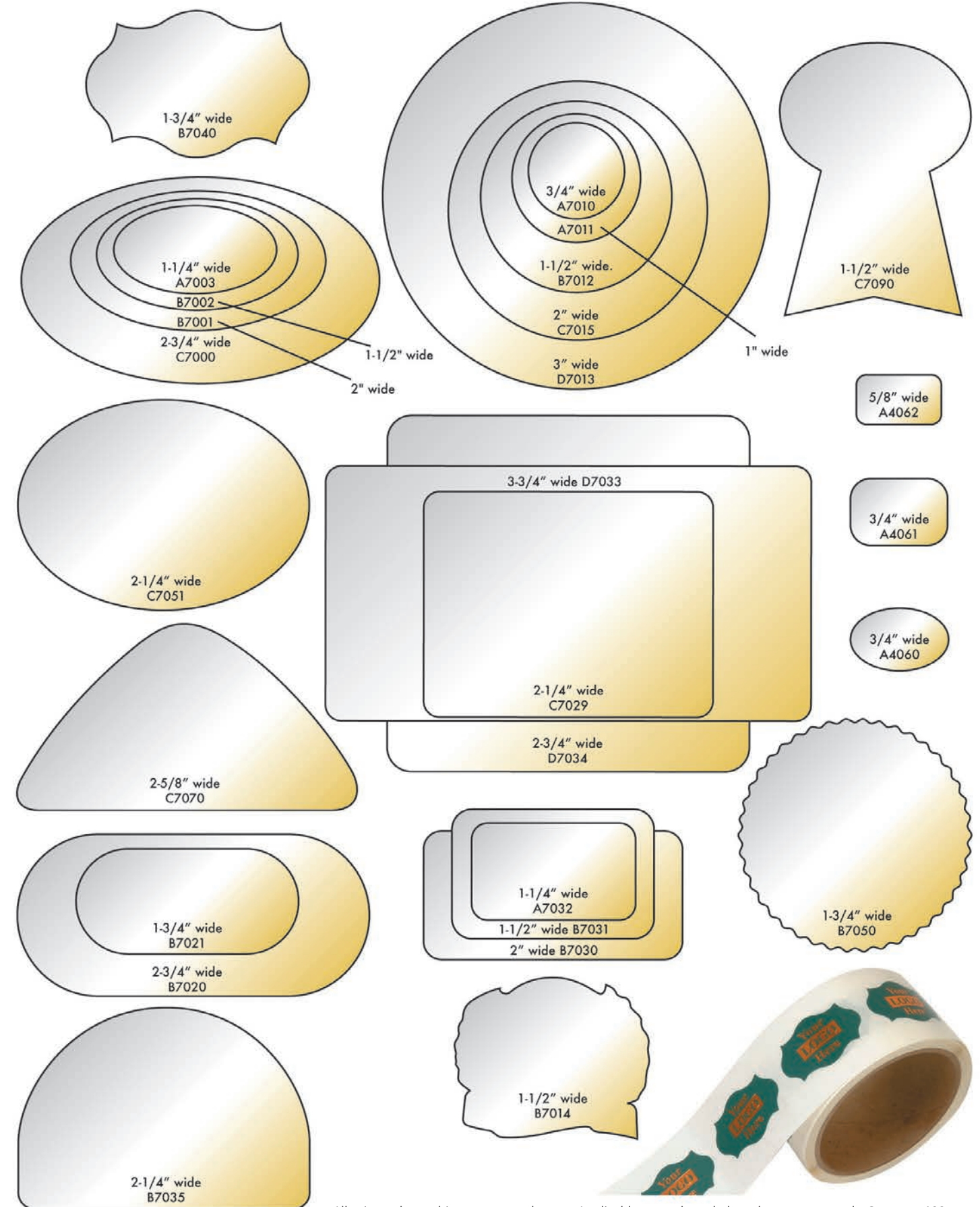

All print orders subject to set-up charges. Applicable artwork, and plate charges may apply. See page 122.

All print orders subject to set-up charges. Applicable artwork, and plate charges may apply. See page 122.

SPECIAL ORDER

SPECIAL ORDER

Please allow 4 - 6 weeks for printing from approved art. NO PLATE CHARGE!

Custom Full Color Seals

Full color, edge to edge print.
Thirty sizes to choose from.
"Picture Perfect" Seals

Speak with
your Sales
Representative
to order.

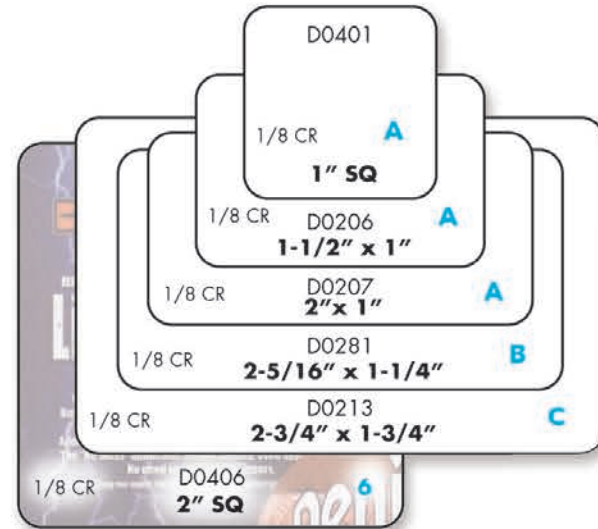

Please allow 4 - 6 weeks for printing from approved art.
NO PLATE CHARGE!

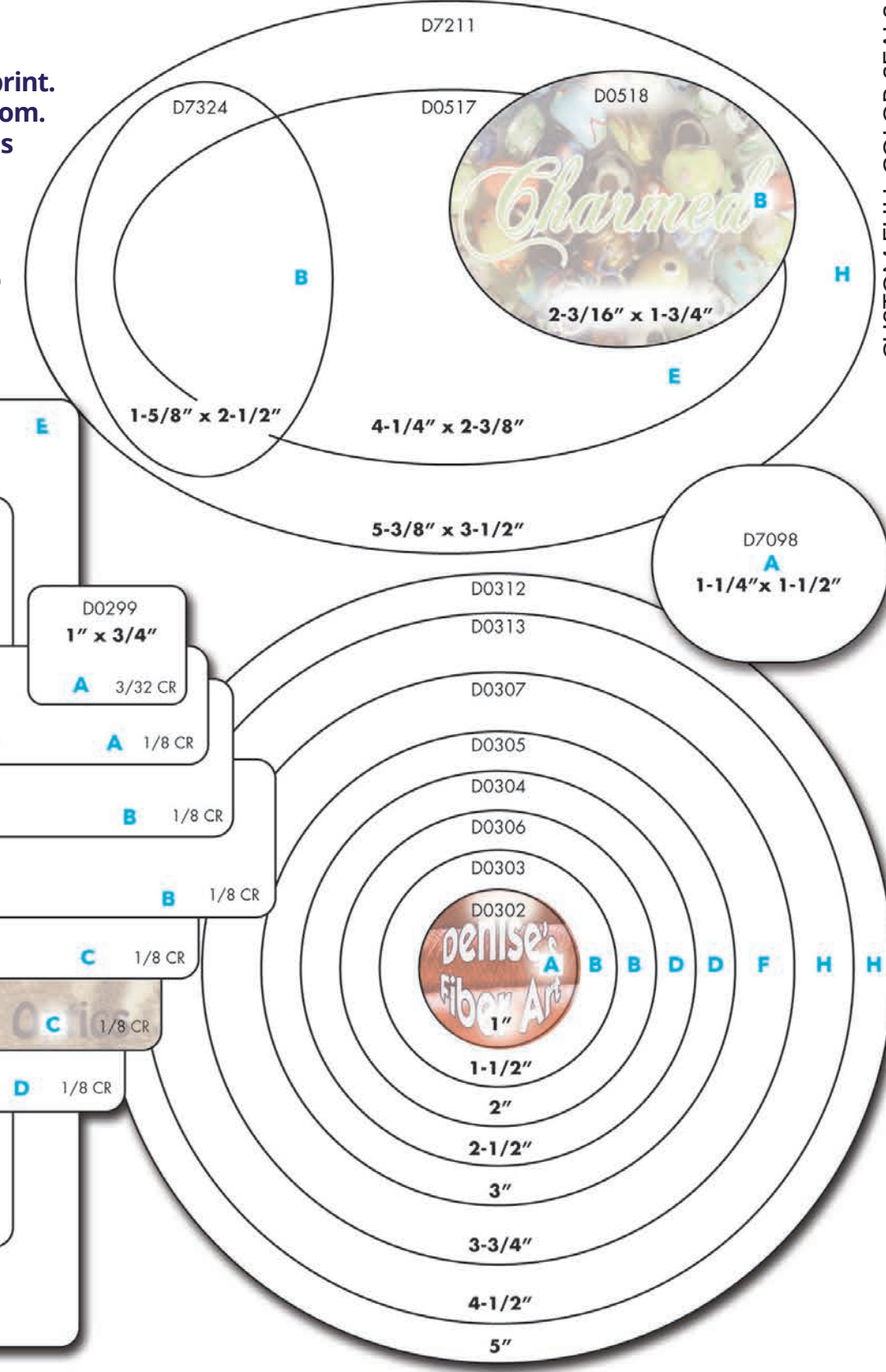
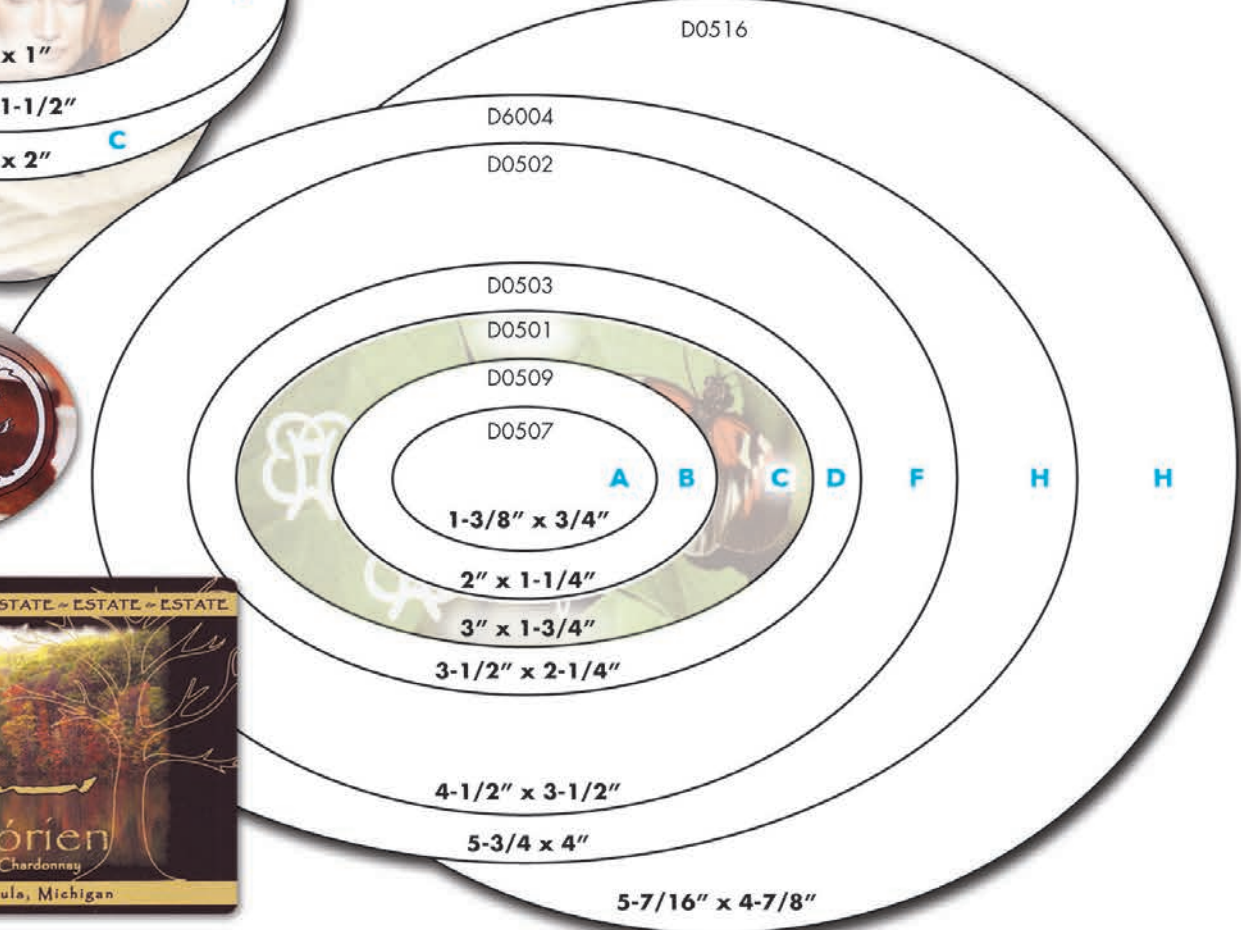
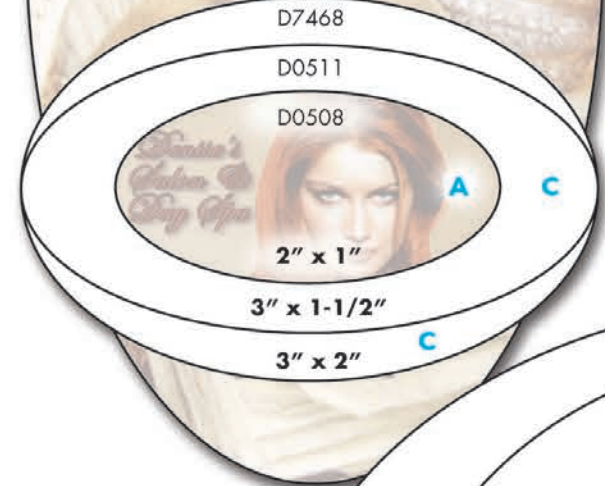
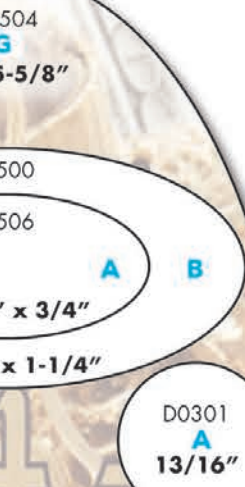
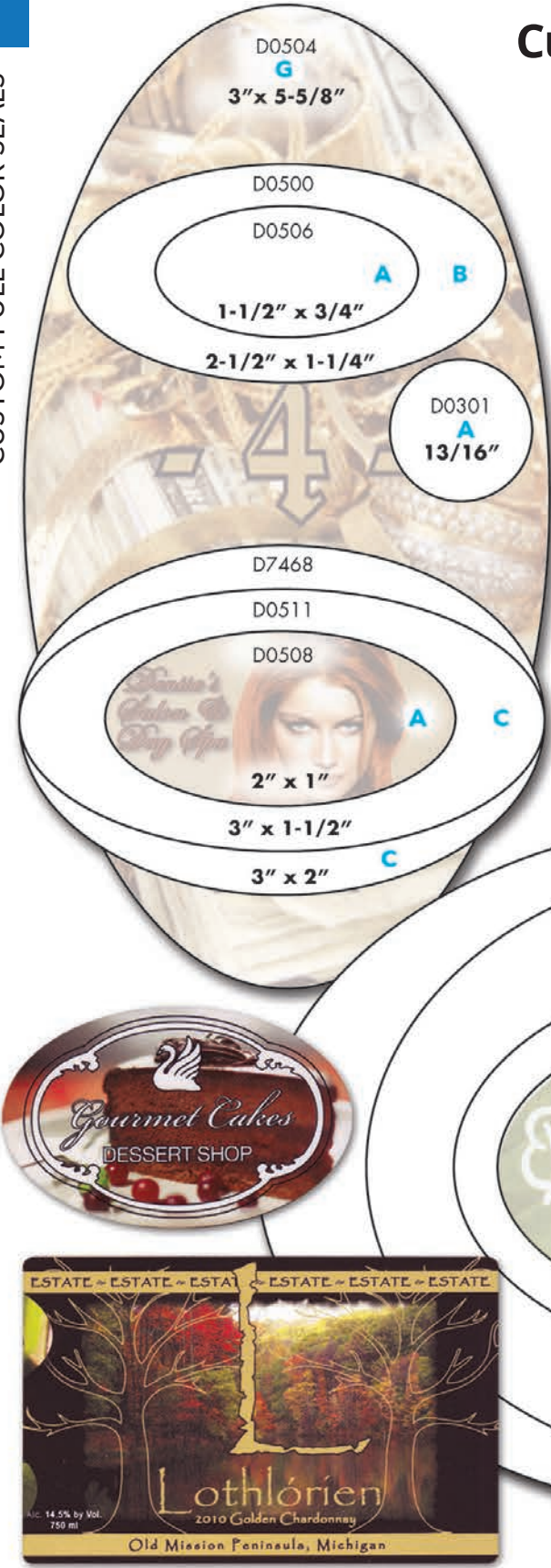





CUSTOM FULL COLOR SEALS

CUSTOM FULL COLOR SEALS

PRINTING INFORMATION

Have your name and logo printed... it's easy!

1. Select your box or bag style, color and size.
2. Choose the printing method you wish to use.

-  A. **FOIL PRINTING:** Foil is applied to the bag or box using a combination of heat and pressure on a magnesium print plate to create an elegant appearance. Choice of Metallic or Matte foils. Cost of Foil Printing Print plate per size and color - \$77.00 (maximum 30 square inches)
-  B. **PAD PRINTING:** Ink is applied to smooth surfaces allowing us to print your logo in places never before possible. Cost of Pad Print plate per size and color - \$104.50 (maximum 3.75 square inches)
-  C. **INK IMPRINTING:** Ink is applied to the box or bag using a rubber printing plate. This method is ideal for larger coverage imprints and is economically priced. Cost of Ink Printing Plate per size per color starting at \$137.50. (maximum 25 square inches)
-  D. **SILK SCREEN:** Die fast ink is applied to Fabric Style Bags through a screen. The process allows the ink to permeate into the fabric dimples for optimal coverage. Screen charge of \$65.00 applies with each order.
-  E. **FULL COLOR DIGITAL PRINTING:** Utilizing the latest 4-color process technology, we now offer full color digital printed graphics on fabric and nylon bags using a heat press process. This full color digital printing creates a transfer that allows for vibrant images on both lights and darks. Pricing is the same regardless of the amount of colors used in a design. Have your full color image applied to your bags for just \$2.15 per bag (minimum 300 bags)

3. Choose the Imprint Color

When Foil Printing, select from 41 foil colors in 4 different finishes: Metallic (High Sheen or Matte), Flat, Gloss or Pearlized. For ink printing select from our 9 Standard colors for in stock items, or ask about Pantone Matching for Special Order items such as Simply Bags and Fabric Style Bags.

4. Send us your artwork.

If you are a new print customer, send us your artwork by e-mail. Artwork must be vector with fonts outlined or high resolution (300 dpi) jpg if vector can not be located.

If you don't have artwork or your artwork needs adjustments, we have a talented design team who can assist you. Contact one of our sales representatives or email us your ideas today. For pricing, see the artwork charges section.

Acceptable Artwork Formats

- Vector files (preferred): Adobe Illustrator with .ai, .eps, or .pdf file extension. If the logo was ever professionally made, at a marketing agency, print shop or sign maker, they will have the logo on file. Check with the original graphic designer. If vector cannot be provided, ALL raster formats will be subject to additional art charges as in most cases it will have to be converted to a vector to meet our printers requirements.
- Raster files: (ie. PDF, PSD, TIF, or JPEG) Actual size, high resolution (300dpi or more), is required for all full color reproduction.
- Please include fonts (.ttf) or convert fonts to outlines when sending ANY Illustrator file, saved as AI, EPS or PDF.

The following formats are NOT acceptable

- Publisher (.pub) • CorelDraw (.cdr) • small GIF or BMP internet images • low resolution JPG
- Any Word or spreadsheet documents - '.docx', '.xls', '.wpd', '.od'

If unsure about any format including "what is a vector" please send all inquiries to your inside Customer Service Rep

OTHER PRINTING COSTS

Artwork Charges: As mentioned above, we have a talented creative team that can work with you to design, create, manipulate or re-size your store logo or name. Artwork service is charged at a rate of \$75.00/hour, min. 1/2 hour.

Set-up Charges: Every print job requires a machine to be set-up. A charge will be applied to every order. Foil, Ink, Pad and Digital printing is charged at \$34.00. Silk Screen printing is \$65. Please note: multiple print sizes of the same logo require multiple set-ups.

Plate Charges: Plate charges apply one-time only. Each time you require a 'new' print design (i.e. Logo change, Print Size Adjustment etc.) a new plate must be created. Once the plate is made, we will hold it for you in our warehouse and it will be available for all future printing requirements. Plate charges range in cost from \$77.00 for a Foil Printing plate to \$137.50+ for an Ink Printing Plate. (maximum 25 square inches)

FOIL STAMPING COLORS

Metallic Options

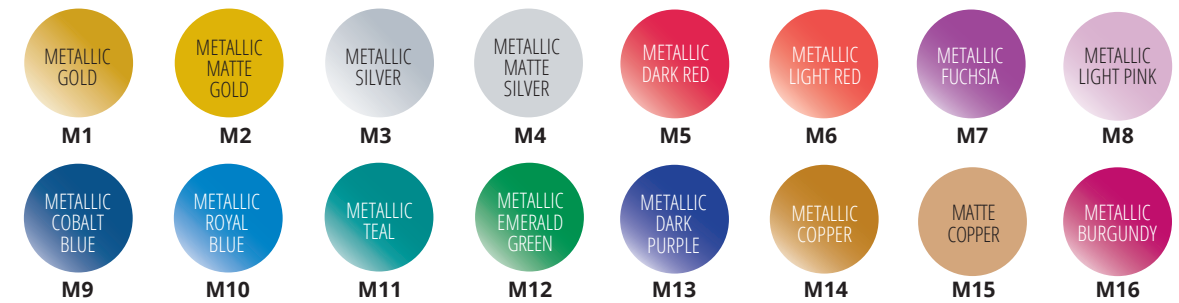

Metallic options feature a high sheen finish unless otherwise indicated as matte finish.

Flat Options



Pearlized Options

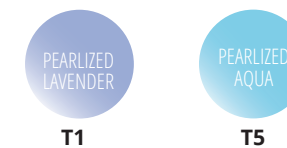

Gloss Options

Gloss Clear - allows the color of the bag or box to show-through. Gives that tone on tone special highlighted look.



Satine Foil Colors



INK IMPRINTING COLORS

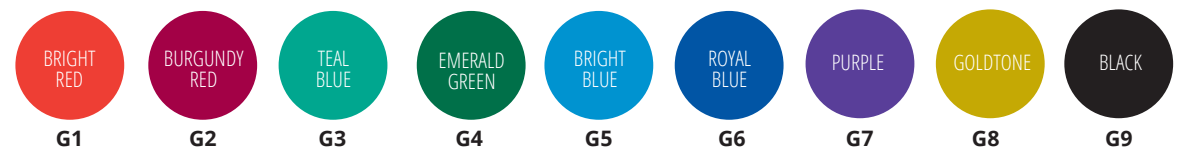

PAD IMPRINTING COLORS

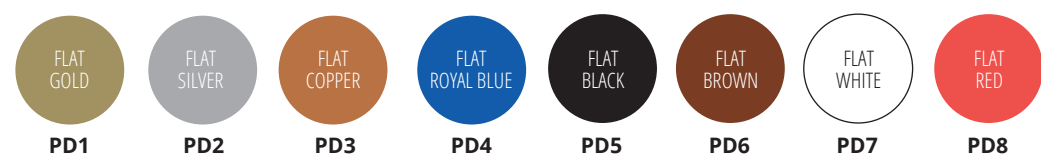

Colors shown are representations only and may not reflect true production colors.



GUNTHERMELE 1857
PACKAGE WITH PURPOSE

TO PLACE AN ORDER

Call Customer Service: 716.821.1472
Toll Free: 1.800.516.0108
Order on line: gunthermele.com
Direct Fax: 716.821.1480



EASY PAYMENT OPTIONS

- Online at: gunthermele.com and pay with your credit card
- Over the phone, by: Visa or Mastercard
- Contact head office to set up ACH

Sign up for paperless billing. See our website for more information.

**PROUD MEMBER
SEE US AT THESE SHOWS IN 2022 !**



January 29 - 31, 2022
RJO Winter Buying Show
July 30 - August 1, 2022
RJO Summer Buying Show



August 19 - 22, 2022
SJO Summer Buying Show



March 12 - 15, 2022
IJO Winter Buying Show
July 23 - 26, 2022
IJO Summer Buying Show



June 9 - 12, 2022



PROUD MEMBER

TERMS AND CONDITIONS:

- Minimum order \$250.00.
- F.O.B point: Buffalo, NY USA
- Net 30 days O.A.C.
- New account payment terms: Visa or MasterCard 50% deposit with order, balance due upon shipping.
- Defective merchandise will be accepted back for credit only if claimed within 15 days of receipt of shipment. Authorization number must be obtained by contacting our customer service department 1.800.516.0108.

- In-transit damages and shortages must be claimed with the freight carrier at time of delivery.
- All lead times are estimates only (from receipt of approved artwork and credit) and are not guaranteed.
- Plate charges where applicable are:
Foil Print Dies: \$77.00 per size (maximum 30 square inches)
Pad Dies: \$104.50 per size (maximum 3.75 square inches)
Ink Plates \$137.50 (maximum 25 square inches)
- **While we strive for accuracy in our catalogue, actual product may be slightly different than pictured.**
- Prices subject to change without notice.