

# JEWELRY PACKAGING GUIDE

2021 - VOLUME 164



**GUNTHERMELE**<sup>1857</sup>  
PACKAGE WITH PURPOSE





## OUR VISION

“Helping our customers tell their unique brand story while providing a customer experience like no other.”

- Darrell King, President

**WELCOME** to our new packaging guide - our 163rd version since our founding in 1857.

We have some exciting developments in the following pages. Most of the changes we have ushered in this year are centered around a more sustainable approach to our business with an emphasis on the materials we use and the reusability of our products. We have begun to view all of our products through this new lens of eco-minded sustainability. We call this our “**Mission Green**”.

Mission Green drives us to use materials that are either from recycled or sustainable sources. It also focuses us on a vastly overlooked practice in sustainability: reusability.



### RECYCLED

There are two important terms that classify the source of recycled content. These are: post-consumer waste and post-industrial waste. Post-consumer waste (PCW). Wherever possible, we are using paper and now plastics that are derived, at least partially if not fully, from municipal recycling programs and this term post-consumer implies that it has been recovered after consumer use. Post-industrial waste (PIW). Another key source of recycled material. In this instance, scrap material is diverted from the landfill and recycled into new material to be used in production.

Product Examples include: our brand new, Canadian made paper twist shoppers made from paper that is derived from 96% post-consumer waste. Our new “resuede” is a luxurious recycled material that feels like plush suede but is produced using recycled materials to create a luxury look and feel. We feature our resuede material in our new drawer series box (page 41) and our new Eco series of hinged boxes (page 23)

### SUSTAINABLE

FSC - Forestry Stewardship Council. In short, this governing body oversees wood and pulp (paper) products derived from responsibly managed forests. This global governing body is an intricate certification process that verifies paper and its sources. In the instances where paper needs to come from new pulp source, we are choosing to use papers that carry the widely recognized FSC designation.

### REUSABLE

Jewelry packaging has an inherent keepsake quality. Most people will collect jewelry boxes for storage and sentimental value. We have also been studying consumer behavior and there is demand for an after use of jewelry packaging. Our active lifestyles and thirst for travel dictates the need to store and protect jewelry when it is not being worn. With that, we have introduced our new Nano™ collection of luxurious and practical travel pouches that not only present the jewelry exquisitely but also doubles as ongoing storage and protection for our society who is always on the go.

In nearly every category we have exciting new products that meet our Mission Green criteria. These are just the first steps of our journey toward more sustainable and eco-conscious packaging solutions and we hope you'll join us on this important journey.



# MAILERS



## ECO-FRIENDLY – “BE PROUD OF THE WAY YOU SHIP”

At Gunther Mele, we care about our environment and are excited to offer our customers innovative, earth-friendly eco-solutions for their e-commerce packaging needs.

Perfect for those earth conscious businesses who have made the decision to move to more eco-friendly packaging and become more sustainable overall. Our Eco-enclosed e-commerce packaging is the perfect solution offering fully recyclable, reusable and biodegradable packaging which in the end ships lighter than standard shipping boxes and ultimately leads to lower costs. It is proven that goods made with recycled content use less energy, water and create less pollution than their virgin counterparts.

### Recycled Poly Mailers

- 100% recycled post-consumer and post-industrial content, fully recyclable and reusable
- Handy dual self-seal adhesive strip allows for reuse
- Durable, moisture, tear and tamper resistant material
- 2.5 mil thickness

CODE	SIZE (inches)	CASE	PRICE/EACH	
			1+ CASE	4+ CASE
52091286	9 x 12	1000	\$0.18	\$0.17
52101386	10 x 13	1000	\$0.20	\$0.19
52121586	12 x 15.5	500	\$0.25	\$0.24

CODE	SIZE (inches)	CASE	PRICE/EACH	
			1+ CASE	4+ CASE
52060986	6 x 9	1000	\$0.13	\$0.12
52071086	7.5 x 10.5	1000	\$0.15	\$0.14
52141986	14.5 x 19	250	\$0.39	\$0.38
52192486	19 x 24	125	\$0.65	\$0.62
52242486	24 x 24	125	\$0.83	\$0.79

### Padded Paper Mailers

- 100% recycled content, fully recyclable and naturally biodegradable
- Outer layer constructed from Kraft paper and padded with layered cushioning of recovered newspaper
- Tamper-evident, self-seal adhesive closure

CODE	SIZE (inches)	CASE	PRICE/EACH	
			1+ CASE	4+ CASE
52060976	6 x 9	250	\$0.33	\$0.31
52081176	8.5 x 11	100	\$0.58	\$0.55

CODE	SIZE (inches)	CASE	PRICE/EACH	
			1+ CASE	4+ CASE
52101576	10.5 x 15	100	\$0.89	\$0.85



100% Recycled

Made in the US



**FOIL PRINT**  
100+ 29¢ each  
1000+ 26¢ each  
2500+ 22¢ each



**PAD PRINT**  
100+ 29¢ each  
1000+ 26¢ each  
2500+ 22¢ each

Estimated lead time: 2 - 3 weeks for IN STOCK and 3 - 5 weeks for SPECIAL ORDER for printed items from approved art.

### Paper Apparel Mailers

- 100% recycled content, 90% post-consumer waste, fully recyclable and naturally biodegradable
- Internal creasing 1.5" from the sides for top and bottom expandability
- Tamper-evident, self-seal adhesive closure

CODE	SIZE (inches)	CASE	PRICE/EACH	
			1+ CASE	4+ CASE
52101375	10 x 13	200	\$0.51	\$0.48
52121575	12 x 15.5	150	\$0.61	\$0.58
52101975	10.5 x 4 x 19	100	\$0.70	\$0.67

CODE	SIZE (inches)	CASE	PRICE/EACH	
			1+ CASE	4+ CASE
52070975	7 x 9	250	\$0.30	\$0.29



**FOIL / PAD PRINT**  
100+ 29¢ each  
1000+ 26¢ each  
2500+ 22¢ each



**INK PRINT**  
100+ 28¢ each  
1000+ 24¢ each  
2500+ 20¢ each



### Rigid Paper Mailers

- 90% post-consumer content, fully recyclable and naturally biodegradable
- Constructed from sturdy 28 pt. paperboard
- Features convenient self-seal closure
- Ideal for shipping photos, stationary, documents, etc

CODE	SIZE (inches)	CASE	PRICE/EACH	
			1+ CASE	4+ CASE
52061012	6 x 10	500	\$0.24	\$0.23
52061212	6 x 2.5 x 12	500	\$0.33	\$0.31
52091412	9.5 x 14.5	250	\$0.37	\$0.36

CODE	SIZE (inches)	CASE	PRICE/EACH	
			1+ CASE	4+ CASE
52081212	8.5 x 12	250	\$0.30	\$0.29
52101612	10.5 x 16	250	\$0.48	\$0.46
52121912	12.5 x 19	250	\$0.50	\$0.48



**FOIL / PAD PRINT**  
100+ 29¢ each  
1000+ 26¢ each  
2500+ 22¢ each



**INK PRINT**  
100+ 28¢ each  
1000+ 24¢ each  
2500+ 20¢ each

Estimated lead time: 2 - 3 weeks for IN STOCK and 3 - 5 weeks for SPECIAL ORDER for printed items from approved art.



### Bubble Poly Mailers - NO PRINT

- 32.6% post-industrial recycled content (51% recycled content in the outer layer, 8% recycled content in the bubble layer and 8% recycled content in the capping layer)
- Reusable: Dual self-seal adhesive strip allows for reuse
- Fully Recyclable, durable, moisture, tear and tamper resistant
- Padding Thickness: 0.11 in / Overall Thickness: 0.25 in

CODE	SIZE (inches)	CASE	PRICE/EACH	
			1+ CASE	4+ CASE
52040600	4 x 6.75	500	\$0.23	\$0.22
52060800	6.5 x 8.75	250	\$0.29	\$0.27
52081000	8.5 x 10.75	100	\$0.38	\$0.36



**Custom printing available.  
Minimum 25,000 quantities.**

# TRENDING

# ECO CHIC



**Vantage II Hinged**  
Gold linen emboss pattern.  
See page 31



**Vantage II Hinged**  
Silver linen emboss pattern.  
See page 31



**EcoBox Hinged**  
Mission Green Industry Leading  
Environmentally Friendly hinged solution.  
See page 23



**Grosgrain Handle Eurotote**  
Beautiful gloss and matte eurotote with  
grosgrain handle.  
See page 82



**5th Avenue Luxury**  
Embossed laminated luxury eurotote with  
coordinating color inside.  
See page 85



**Manhattan Wide Gusset Eurotote**  
New 12" wide gusset are perfect for large  
gift or home decor.  
See page 87



**Drawer Box**  
Mission Green Environmentally Friendly,  
Industry Progressive  
drawer-style paperboard solution.  
See page 41



**Vantage II Eurototes**  
Coordinating Vantage Eurototes  
See page 80



**Vision Box & Stand**  
Transparent 3D window box with  
coordinating stand.  
See page 41



**Kraft Paper Bag with Die Cut Handle**  
Mission Green - Sustainable Solution to replace  
single use plastic shoppers.  
See page 89



**RPET Bottle Reusable**  
Mission Green - Sustainable 80% woven  
recycled PET laminated tote.  
See page 99



**Eco-Enclose**  
Mission Green - Sustainable  
E-Commerce Packaging.  
See page 4-5 and 110



# CYOL

Jewelry Display



# IN STOCK

Jewelry Display



- Platforms and Risers
- Ring Showcase
- Pendant & Earring Stands
- Neck Forms & Bracelet Stands
- Trays, Counter Pads,  
Chain Ramps
- Open Stock and Prepacks  
Available

**Save 25% when you buy  
\$500 or more!**

Financing Programs Available

Tell your brand story

Create your unique identity

Elevate the  
shopping experience

Drive more sales

**Complimentary  
Display Design**

\*Complete set of renderings available with payment of deposit.  
Deposits will be deducted from invoice at time of billing.





# PROPOSAL

Ring Presentation



## Proposal Ring Hinged Box

- Single ring box with matching ribbon pull accent and ring clip
- Brushed ivory linea interior
- White sleeve packer
- Minimum case pack 12

36220 \_ \_ \_ \_  
2.36" x 2.36" x .94"  
**\$2.86 each** (12+)  
**\$2.49 each** (144+)

Estimated lead time: 2 - 3 weeks for printed items from approved art.

- FOIL / PAD PRINT**  
12+ 29¢ each  
144+ 26¢ each  
504+ 22¢ each

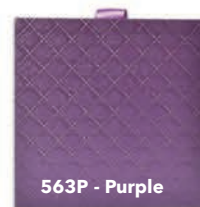

# PROPOSAL

Ring Presentation



**DISCONTINUED**

## Evolution

Twist motion modern approach to jewelry presentation.

- Stainless steel construction 68021 \_ \_ \_ \_
- Flocked ring pad 2.125" x 1.625"
- \$8.79/ea.** 12/case



Twist the cylinder to raise and reveal the special ring inside.

Twist the cylinder to raise and reveal the special ring inside.

Minimum order 12.  
Estimated lead time: 2 - 3 weeks for printed items from approved art.

- FOIL / PAD PRINT**  
12+ 29¢ each  
144+ 26¢ each  
504+ 22¢ each



## Ring Stash

The solution to bulky engagement ring boxes.

- Discreet compact size
- Flexible ring clip firmly holds the ring in place
- Magnetic closure
- Light weight and durable 68021015L
- Black sleeve packer 2.32" x 2.44" x .55
- Printing options available **\$14.25/ea.** 12/case
- U.S. Patent #9375066

**You've sold the perfect ring.  
They've planned the perfect moment.  
Help them keep it a secret.**

Minimum order 12.  
Estimated lead time: 2 - 3 weeks for printed items from approved art.

- FOIL PRINT**  
12+ 29¢ each  
144+ 26¢ each  
504+ 22¢ each



# TABLE OF CONTENTS

## Jewelry Packaging

Proposal Ring Specialty Boxes .....	10 - 11
Hinged Packaging .....	13 - 41
<b>New</b> EcoBox .....	23
<b>New</b> New Vantage .....	31
<b>New</b> Drawer Box .....	41
<b>New</b> Vision Box .....	41
Paperboard Jewelry Packaging .....	42 - 47
Nest Boxes .....	48 - 50

Jewelry Folders .....	51
Create Your Own Look Steps .....	52 - 53
Gift Card and Certificate Boxes .....	54 - 55
Pouches .....	56 - 57
Jewelry Cloths and Cleaners .....	58 - 59
Repair Envelopes and Tags .....	60

## Jewelry Display

Create Your Own Look Element and Showcase Platform Styles .....	61 - 62
Create Your Own Look Displays and Color Options .....	63 - 65

<b>New</b> In Stock Jewelry Displays .....	66 - 74
--	---------

## Watch Winders & Storage

Watch Winders .....	75 - 77
Fashion and Travel .....	78

## Bags

<b>New</b> Vantage, Eclipse and Geo Eurototes .....	80
Rope Handle Paper Totes .....	81
<b>New</b> Grosgrain Handle Eurototes .....	82
All Paper Eurototes .....	83
CYOL Rope Handle .....	84
<b>New</b> 5th Avenue Eurototes .....	85
<b>New</b> Manhattan Eurototes .....	86 - 87
CYOL Gusset Merchandise .....	88
<b>ECO</b> Kraft Paper with Die Cut Handle .....	89
CYOL Simple Paper .....	90
<b>ECO</b> Paper Twist Handle .....	91 - 92

San Francisco Shoppers .....	92
Damask and Kraft Merchandise Bags .....	93
Custom Printed Poly Shopping Bags .....	94
Frosted and Celestial Bags .....	95
Custom Printed Poly Merchandise Bags .....	96
Poly Merchandise Bags .....	97
<b>ECO</b> Custom Full Color Laminated Reusable .....	98
RPET Laminated Totes - Recycled From Bottles! .....	99
<b>ECO</b> Reusable Fabric Shoppers .....	100
Toronto Tote - Reusable Fabric Shoppers .....	101
Apparel Bags .....	102

## Gift Boxes and E-Commerce

White Folding Gift Boxes .....	104
Apparel Boxes .....	104
Tuckit® Boxes .....	105
Special Order Pop-Up Boxes .....	105
Malibu Magnetic Gift Box .....	106

Giftalicious Pop-up Boxes .....	106
Custom E-Commerce Boxes .....	108
Custom Poly Mailers .....	108
<b>New</b> E-Commerce Corrugated Boxes .....	109
EcoEnclose Mailer Envelopes .....	4 - 5 & 110
<b>New</b> Food Service .....	

## Finishing Touches

Tissue Paper .....	112 - 113
<b>New</b> Inspirations Gift Wrap .....	114 - 115
Jewelers Rolls .....	117
Special Order Gift wrap .....	116 - 119
Bows, Cellophane and Dispensers ..	120 - 121

Printed and Unprinted Ribbon .....	122 - 125
Customized Seals - Foil Print .....	126 - 127
Customized Seals - Full Color .....	128 - 129
Print Information and Colors .....	130

# JEWELRY PACKAGING





# CREATE YOUR OWN LOOK

JEWELRY PACKAGING



## WOOD SERIES

The possibilities are endless when you choose wooden materials. Endless and timeless, in terms of size, shape, finish and color. High-end style, this collection features our Monterey series shape with a high gloss white finish, black "reveal" edge and black linea interior. Add a matching custom tote bag to complete the look.

Wood Create Your Own Look Programs start as low as: \$5.61 for the ring box

# IN STOCK Hinged Boxes

JEWELRY PACKAGING



**COORDINATING  
EUROTOTES**  
See page 81

Available Colors



Outer Box  
**150MC - Black Gloss**



Outer Box  
**320M - Mahogany**



**150MCB -  
OPTIONAL  
BLACK INTERIOR  
RING BOX ONLY**

## Monterey II

Wood series with modern lines and a gloss finish.

- Soft white leatherette interior
- Packaged in a 2-piece white traditional outer box

CODE	DESCRIPTION	SIZE (inches)	PRICE /EACH	
			12+	144+
36821 _ _ _ _	Ring	2.375 x 2.375 x 2	\$6.47	\$5.61
36822 _ _ _ _	Earring	2.375 x 2.375 x 2	\$6.47	\$5.61
36843 _ _ _ _	Utility T-pad	4 x 4 x 2	\$11.80	\$9.99
36850 _ _ _ _	Watch	4.375 x 4.375 x 2.75	\$13.26	\$11.89
36893 _ _ _ _	Bracelet	9.5 x 2.375 x 1.5	\$12.96	\$11.63
36813 _ _ _ _	Necklace	7.5 x 7.5 x 2	\$21.98	\$19.72

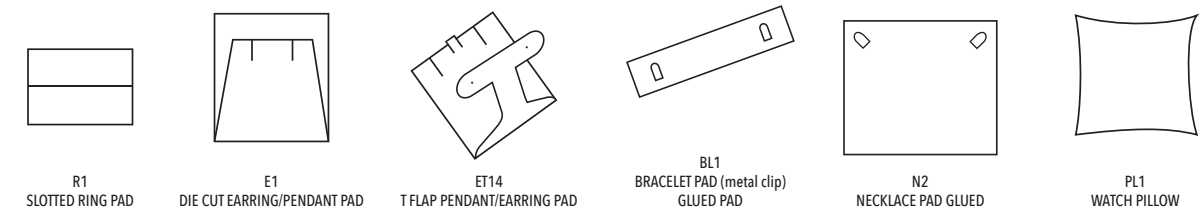

**FOIL / PAD PRINT**  
12+ 29¢ each  
144+ 26¢ each  
504+ 22¢ each

Minimum 12 per style.  
Please allow 2 - 3 weeks for printed items from approved art.

All print orders subject to set-up charges. Applicable artwork, and plate charges may apply. See page 130.



# IN STOCK

## Hinged Boxes



**COORDINATING  
EUROTOTE**  
See page 81

Available Color



### Brougham

Vintage inspired wooden box.

- Wood lacquered top and bottom, leatherette sides, cream satin top liners with blue velvet pads
- Features patented working button
- Matching packer

CODE	DESCRIPTION	SIZE (inches)	PRICE /EACH	
			12+	144+
36921113	Ring	1.875 x 2 x 1.875	\$9.11	\$8.31
36932113	Earring	2.5 x 2.625 x 1.5	\$10.52	\$9.47
36963113	Pendant/Earring	3.25 x 3.5 x 1.75	\$12.76	\$11.48
36993113	Bracelet	8.75 x 2.125 x 1.375	\$15.94	\$14.35
36973113	Necklace*	7.375 x 7.5 x 1.75	\$22.33	\$20.10

\* wood base only.

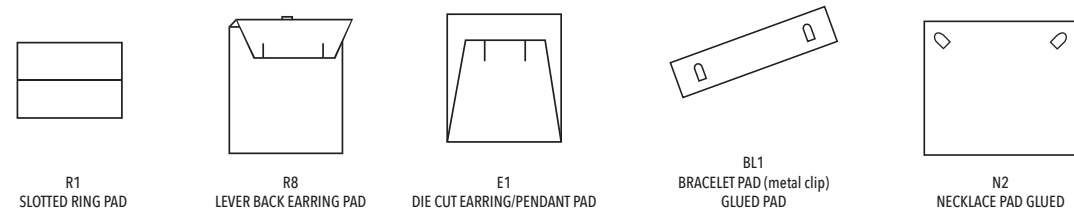

**FOIL / PAD PRINT**  
12+ 29¢ each  
144+ 26¢ each  
504+ 22¢ each

Minimum 12 per style.  
Please allow 2 - 3 weeks for printed items from approved art.



# IN STOCK

## Hinged Boxes



**COORDINATING  
EUROTOTE**  
See page 81



50% Recycled Shell

Available Colors



114 - Blue

674 - Green

### Estate

Contemporary style with a touch of tradition.

- White velvet pads and satin top liners
- Packaged in a coordinating 2-piece outer box

CODE	DESCRIPTION	SIZE (inches)	PRICE /EACH	
			12+	144+
36021 ___	Ring	2 x 2.25 x 1.875	\$4.03	\$3.80
36022 ___	Earring	2 x 2.125 x 1.625	\$4.03	\$3.80
36084 ___	Utility T-pad	3.5 x 3.5 x 1.5	\$4.79	\$4.35
36093 ___	Bracelet	8.5 x 2.125 x 1	\$7.72	\$7.19
36073 ___	Necklace	7.125 x 4.375 x 1.25	\$9.27	\$8.50



**FOIL / PAD PRINT**  
12+ 29¢ each  
144+ 26¢ each  
504+ 22¢ each

Minimum 12 per style.  
Please allow 2 - 3 weeks for printed items from approved art.





# CREATE YOUR OWN LOOK

JEWELRY PACKAGING



## WHISPER SERIES

Our modern luxury box is shown here in a stylish textured gold paper called: Shuttle. Matching interior and pads create a seamless look.  
Whisper Create Your Own Look Programs starts as low as: \$5.39 for the ring box

# IN STOCK Hinged Boxes

JEWELRY PACKAGING



**COORDINATING  
EUROTOTE**  
See page 81

Available Colors



Outer Box  
**559W - Carbon Black**



Outer Box  
**009W - Moon Glow**



Outer Box  
**289W - Palladium**

## Whisper

Elegant curves and round corners.

- Monochromatic metallic pinkskech linea fabric
- Packaged in a coordinating 2-piece outer box

CODE	DESCRIPTION	SIZE (inches)	PRICE/EACH	
			12+	144+
36821	Ring	2.375 x 2.375 x 2.125	\$6.22	\$5.39
36822	Earring	2.375 x 2.375 x 2.125	\$6.22	\$5.39
36823	Large Ring	3.25 x 3.25 x 2.25	\$9.06	\$7.88
36883	Utility T-pad	3.25 x 3.25 x 2.25	\$8.38	\$7.25
36850	Watch	4 x 4 x 2.75	\$11.33	\$9.85
36893	Bracelet	9.25 x 2.5 x 1.75	\$11.17	\$9.71
36873	Necklace	6.5 x 8 x 1.75	\$17.46	\$14.34

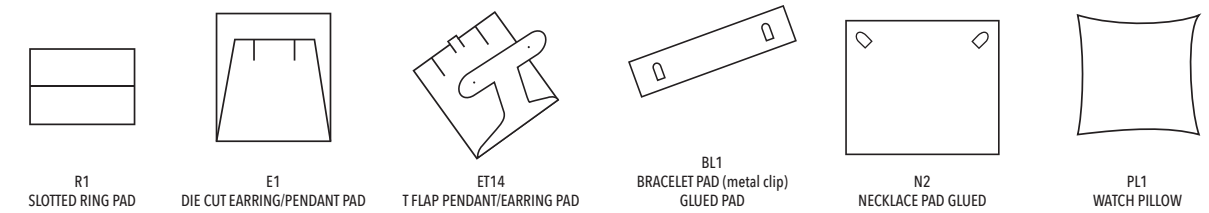

**FOIL / PAD PRINT**  
12+ 29¢ each  
144+ 26¢ each  
504+ 22¢ each

Minimum 12 per style.  
Please allow 2 - 3 weeks for printed items from approved art.

All print orders subject to set-up charges. Applicable artwork, and plate charges may apply. See page 130.



# CREATE YOUR OWN LOOK

JEWELRY PACKAGING



## ECLIPSE SERIES

This eclipse collection features an elegant champagne linea covering with an ivory shimmer interior and gold printed logo on the logo on the top liner. The custom rope handle tote completes this beautiful collection.

Eclipse Create Your Own Look Programs starts as low as: \$3.62 for the ring box

# IN STOCK Hinged Boxes

JEWELRY PACKAGING



**COORDINATING  
EUROTOTE**  
See page 80

Available Colors



Outer Box

**813 - Linea Blue Celestial**



Outer Box

**663 - Linea Aubergine**



Outer Box

**423 - Brown**



50% Recycled Shell

## Eclipse

Classic square corners with a distinctive crescent style front.

- Packaged in full-depth 2-piece outer box

CODE	DESCRIPTION	SIZE (inches)	AUBERGINE AND BLUE PRICE/EACH		BROWN PRICE/EACH	
			12+	144+	12+	144+
36821 ___	Ring	2.5 x 2.5 x 1.75	\$5.60	\$5.04	\$4.00	\$3.62
36822 ___	Earring/Pendant	2.5 x 2.5 x 1.75	\$5.60	\$5.04	\$4.00	\$3.62
36883 ___	Utility T-pad	3.75 x 4 x 1.75	\$9.67	\$8.72	\$7.01	\$6.30
36893 ___	Bracelet	9.25 x 2.5 x 1.75	\$12.49	\$11.24	\$7.71	\$6.96
36873 ___	Necklace	6.5 x 8 x 1.75	\$20.23	\$18.22	\$15.75	\$14.22
36850 ___	Watch	3.75 x 4.25 x 3	\$13.48	\$12.12	\$8.97	\$8.09

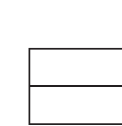

R1  
SLOTTED RING PAD

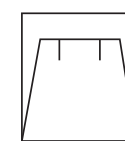

E1  
DIE CUT EARRING/PENDANT PAD

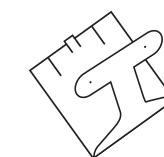

ET14  
T FLAP PENDANT/EARRING PAD

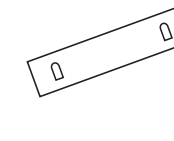

BL1  
BRACELET PAD (metal clip)  
GLUED PAD

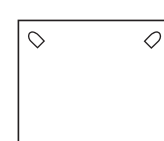

N2  
NECKLACE PAD GLUED

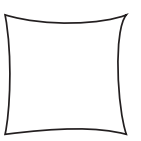

PL1  
WATCH PILLOW



See page 52.

**FOIL / PAD PRINT**  
12+ 29¢ each  
144+ 26¢ each  
504+ 22¢ each

Minimum 12 per style.  
Please allow 2 - 3 weeks for printed items from approved art.

All print orders subject to set-up charges. Applicable artwork, and plate charges may apply. See page 130.



# IN STOCK

## Hinged Boxes

# IN STOCK

## Hinged Boxes

JEWELRY PACKAGING

JEWELRY PACKAGING



**COORDINATING EUROTOTE**  
See page 81

Available Color



Outer Box

### Palladium Inlay

**Stylish contemporary series.**

- Palladium grey brushed exterior
- Cream pads and top liner with matching exterior edge
- Packaged in a coordinating 2-piece outer box

CODE	DESCRIPTION	SIZE (inches)	PRICE/EACH	
			12+	144+
36221283P	Ring	2.25 x 2 x 1.75	\$5.04	\$4.13
36222283P	Earring	2.25 x 2 x 1.75	\$5.04	\$4.13
36283283P	Utility T-pad	3.18 x 4.17 x 1.41	\$7.10	\$6.03
36293283P	Bracelet	8.6 x 2.16 x 1	\$8.16	\$6.84
36273283P	Necklace	6.25 x 4.4 x 1.4	\$9.75	\$8.22



**FOIL / PAD PRINT**  
 12+ 29¢ each  
 144+ 26¢ each  
 504+ 22¢ each

Minimum 12 per style.  
Please allow 2 - 3 weeks for printed items from approved art.



See page 52.



**COORDINATING EUROTOTE**  
See page 83

Available Color



Outer Sleeve

### EcoBox

**Modern look inside and out.**

- Gunther Mele Mission Green product
- Made with recycled paper exterior
- Made with 50% recycled material plastic shell
- Resuede interior material (49% recycled)

CODE	DESCRIPTION	SIZE (inches)	PRICE /EACH	
			12+	144+
36121000	Ring/Earring	2 x 2 x 1.5	\$3.54	\$3.01
36163000	T-Pad Pendant/Earring	3.75 x 3.75 x 1.33	\$5.69	\$4.84
36193000	Bracelet	8.5 x 2 x .91	\$5.01	\$4.26
36173000	Necklace	7 x 5 x 1.10	\$9.09	\$7.73

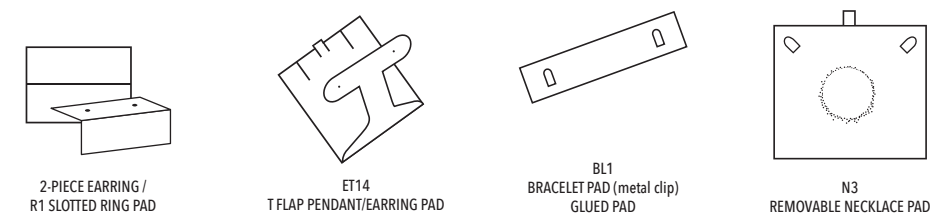

**FOIL / PAD PRINT**  
 12+ 29¢ each  
 144+ 26¢ each  
 504+ 22¢ each

Minimum 12 per style.  
Please allow 2 - 3 weeks for printed items from approved art.



See page 52.



50% Recycled Shell

All print orders subject to set-up charges. Applicable artwork, and plate charges may apply. See page 130.

All print orders subject to set-up charges. Applicable artwork, and plate charges may apply. See page 130.



# CREATE YOUR OWN LOOK

JEWELRY PACKAGING



## ROMA SERIES

This customized look combines a grey lizard pattern covering with a clean white leatherette interior. A custom all-paper eurotote is added to coordinate with this collection.

Roma Create Your Own Look Programs starts as low as: \$3.69 for the ring box

# IN STOCK

## Hinged Boxes



**COORDINATING  
EUROTOTE**  
See page 85

**OPTIONAL  
BLACK INTERIOR  
AVAILABLE**  
153B - Black on Black

Available Colors



Outer Box

**153 - Black**



Outer Box

**123 - Brown**



**Envelope Pouch**  
See page 56

## Roma

**Distinctive round corner styling with sculpted sides.**

- Lizard style embossed covering with leatherette interior
- Packaged in a 2-piece coordinating outer box with ¼ depth lids

CODE	DESCRIPTION	SIZE (inches)	PRICE /EACH	
			12+	144+
36421 ___	Ring	2.25 x 2.25 x 1.75	\$4.09	\$3.69
36422 ___	Earring	2.25 x 2.25 x 1.75	\$4.09	\$3.69
36484 ___	Utility T-pad	3.75 x 3.75 x 2	\$6.17	\$5.28
36493 ___	Bracelet	9.375 x 2.25 x 1.5	\$8.48	\$7.63
36477 ___	Necklace (black only)	7.5 x 7.5 x 2.125	\$16.43	\$14.79



50% Recycled Shell

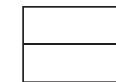

R1  
SLOTTED RING PAD

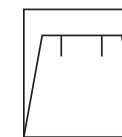

E1  
DIE CUT EARRING/PENDANT PAD

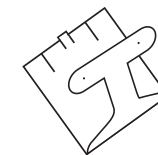

ET14  
T FLAP PENDANT/EARRING PAD

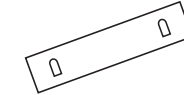

BL1  
BRACELET PAD (metal clip)  
GLUED PAD

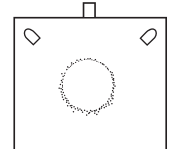

N3  
REMOVABLE NECKLACE PAD



See page 52.



**FOIL / PAD PRINT**

12+ 29¢ each  
144+ 26¢ each  
504+ 22¢ each

Minimum 12 per style.  
Please allow 2 - 3 weeks for printed items from approved art.

All print orders subject to set-up charges. Applicable artwork, and plate charges may apply. See page 130.



# CREATE YOUR OWN LOOK

JEWELRY PACKAGING



## GEO SERIES

A series completely unique with added top stitching to the covering and upgrading the fabric to a luxurious grey leatherette. This Geo collection features a debossed logo on the top of the lid. Matching dark interior pads create a seamless look to showcase fine pieces. Packaged in two-tone ¾ depth outer box with a silver embossed print. This collection is completed with coordinating custom rope handle totes.

Geo Create Your Own Look Programs starts as low as: \$3.10 for the ring box

# IN STOCK Hinged Boxes

## E-Commerce Jewelry Boxes

Deliver the 'in-store' experience to your customer's door  
See page 109 for more information



## COORDINATING EUROTOTE

See page 80



415B - Black Packer with Ivory Pouch  
456P - Purple  
427T - Bronze

Available Colors



873B - Bronze



563P - Purple



153B - Black



083 - Luxe Silver\*

## Geo

Modern texture in a choice of 4 color options.

- Ivory brushed leatherette pads and satin top liners
- Packaged in a coordinating ¾ depth 2-piece outer box

CODE	DESCRIPTION	SIZE (inches)	PRICE /EACH	
			12+	144+
36221	Ring/Earring	2.375 x 2.375 x 2.375	\$3.46	\$3.10
36283	T-pad Pendant	3.5 x 4.5 x 1.5	\$4.57	\$3.94
36293	Bracelet	9 x 2.375 x 1.5	\$6.05	\$5.44
36273	Necklace	7 x 7 x 1.5	\$10.29	\$9.26
36220	Proposal Box*	2.36 x 2.36 x .94	\$2.86	\$2.49
36224	Lighted Ring/Earring*	2.36 x 2.36 x 2.36	\$9.51	\$8.80
09030	Pouch with Box*	3 x 4	\$1.88	\$1.58
69221100G	Earring Pad to fit Ring/Earring box (E8)		\$0.66	

\* not available in Luxe Silver



50% Recycled Shell  
and FSC Paper Used

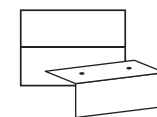

2-PIECE EARRING /  
R1 SLOTTED RING PAD

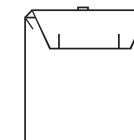

E8  
LEVER BACK EARRING PAD

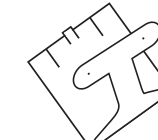

ET14  
T FLAP PENDANT/EARRING PAD

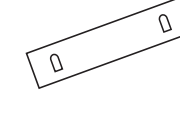

BL1  
BRACELET PAD (metal clip)  
GLUED PAD

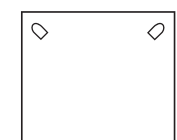

N2  
NECKLACE PAD GLUED



R2  
RING CLIP - PROPOSAL PAD



See page 52.

**FOIL / PAD PRINT**  
12+ 29¢ each  
144+ 26¢ each  
504+ 22¢ each

Minimum 12 per style.  
Please allow 2 - 3 weeks for printed items from approved art.

All print orders subject to set-up charges. Applicable artwork, and plate charges may apply. See page 130.



# SPECIAL ORDER

## Geo Series Boxes and Bags

JEWELRY PACKAGING



Available in 16 colors  
in a selection of 4 luxurious  
textured papers.



Shown in Celestial Blue

Shown in Moss

Shown in Brick

Geo Special Order Program starts as low as: \$3.22 for the proposal box.

Contact your representative for assistance selecting your texture and color.

# SPECIAL ORDER

## Geo Series Boxes and Bags

JEWELRY PACKAGING

### 16 Color Options Available

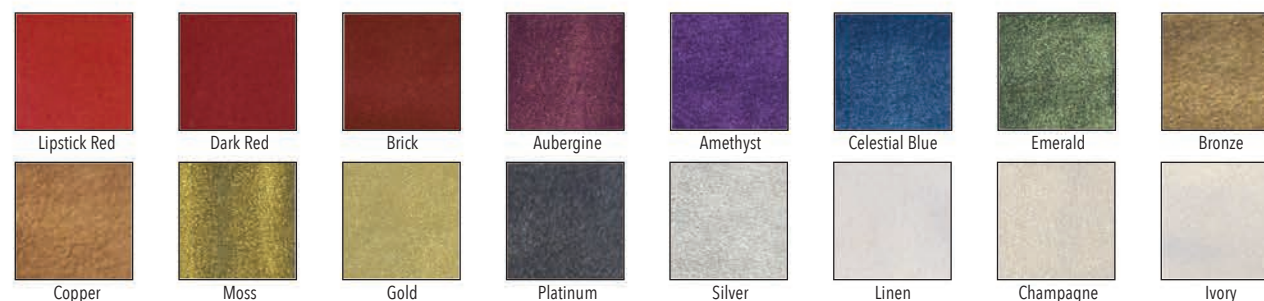

### 4 Texture Paper Options Available



### Geo Hinged Packaging

- Ivory brushed leatherette pads and satin top liners
- Packaged in a coordinating ¾ depth 2-piece outer box

DESCRIPTION	SIZE (inches)	PRICE/EACH
Ring/Earring	2.375 x 2.375 x 2.375	\$4.21
T-pad Pendant	3.5 x 4.5 x 1.5	\$4.91
Bracelet	9 x 2.375 x 1.5	\$5.63
Necklace	7 x 7 x 1.5	\$8.82
Proposal Box	2.36 x 2.36 x .94	\$3.22

 **FOIL PRINT** - INCLUDED IN PRICE  
Top Satin  
Packer Lid

Boxes: Minimum 1500 assorted! (min 100 per box)  
Bags: Minimum 1000 each size with purchase of 1500 boxes.  
Estimated lead time: 12 - 14 weeks for printed items from approved art.

### Geo Eurototes

- 110 gsm uncoated paper with 5 mm rope handles
- Foil printed two sides

SIZE (inches)	PRICE/EACH
6 x 3.5 x 6 x 3.5	\$1.16
9 x 3.5 x 7 x 3.5	\$1.33
10.5 x 5 x 8.5 x 5	\$1.68

 **FOIL PRINT**  
PRINTING INCLUDED IN PRICE

Bags Only: Minimum 3000 each size.  
Estimated lead time: 12 - 14 weeks for printed items from approved art.

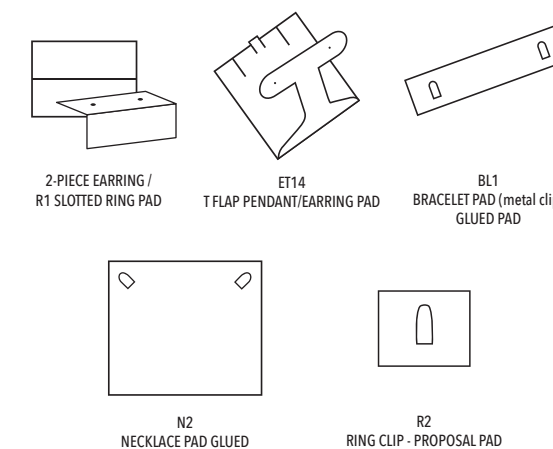

## Our Top Selling Collection Just Got Even Better!

Printing included for  
any of the items in this program.

**Choice of Matte or Metallic Foil Print:  
Gold, Silver, Copper or Black.**

All print orders subject to set-up charges. Applicable artwork, and plate charges may apply. See page 130.



# IN STOCK

## Hinged Boxes



**COORDINATING EUROTOTE**  
See page 81

**NEW AND IMPROVED RING PAD**

Available Colors



**313 - Aqua**

Outer Box



**312 - Brown**

Outer Box



**SMALLER T-PAD BOX IS BACK!**



**50% Recycled Shell and FSC Paper Used**

## Vantage

**Crisp lines in iconic color provide a beautiful presentation.**

- White leatherette interior
- Packaged in a coordinating full-depth 2-piece outer box

CODE	DESCRIPTION	SIZE (inches)	PRICE / EACH	
			12+	144+
36221 ___	Ring	2 x 2 x 1.625	\$3.00	\$2.35
36222 ___	Earring	1.875 x 1.875 x 1.45	\$3.00	\$2.35
36232 ___	T-Pad Pendant	2.64 x 2.72 x 2.165	\$3.41	\$3.09
36284 ___	Utility T-pad	3.5 x 3.5 x 2	\$4.12	\$3.53
36293 ___	Bracelet	8.625 x 2.125 x 1.25	\$5.92	\$4.62
36273 ___	Necklace	6.25 x 4.5 x 1.5	\$7.72	\$6.02

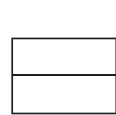

R1  
SLOTTED RING PAD

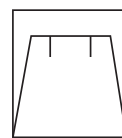

E1  
DIE CUT EARRING/PENDANT PAD

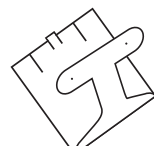

ET14  
T FLAP PENDANT/EARRING PAD

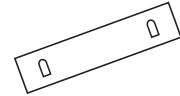

BL1  
BRACELET PAD (metal clip)  
GLUED PAD

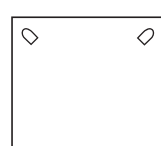

N2  
NECKLACE PAD GLUED



**FOIL / PAD PRINT**  
12+ 29¢ each  
144+ 26¢ each  
504+ 22¢ each

Minimum 12 per style.  
Please allow 2 - 3 weeks for printed items from approved art.



See page 52.

# IN STOCK

## Hinged Boxes



**COORDINATING EUROTOTE**  
See below and on page 80

Available Colors



**307 - Gold**

Outer Box



**308 - Silver**

Outer Box

## Vantage II

**Elegant gold and silver in a linen embossed pattern.**

- White satin top liners and leatherette bottom pads
- Packaged in a coordinating 3/4 depth lid 2-piece outer box



See page 52.

CODE	DESCRIPTION	SIZE (inches)	PRICE / EACH	
			12+	144+
36221 ___	Ring/Earring	2 x 2 x 1.625	\$3.56	\$3.02
36232 ___	T-Pad Pendant	2.64 x 2.72 x 2.165	\$4.28	\$3.65
36284 ___	Utility T-pad	3.5 x 3.5 x 2	\$5.19	\$4.42
36293 ___	Bracelet	8.625 x 2.125 x 1.25	\$7.08	\$5.89
36273 ___	Necklace	6.25 x 4.5 x 1.5	\$8.90	\$7.47

Minimum 12 per style.  
Please allow 2 - 3 weeks for printed items from approved art.



**FOIL / PAD PRINT**  
12+ 29¢ each  
144+ 26¢ each  
504+ 22¢ each

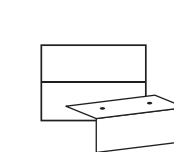

2-PIECE EARRING /  
R1 SLOTTED RING PAD

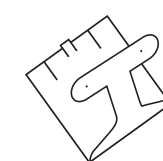

ET14  
T FLAP PENDANT/EARRING PAD

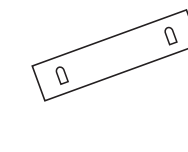

BL1  
BRACELET PAD (metal clip)  
GLUED PAD

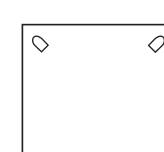

N2  
NECKLACE PAD GLUED



**50% Recycled Shell and FSC Paper Used**

## Coordinating Eurototes.

- 120 gsm uncoated paper with 8mm paper cord handles
- Minimum 100 per color

CODE	SIZE (inches)	PRICE/EACH		
		100+	500+	1000+
A 230606 ___	6 x 3.5 x 6 x 3.5	\$0.83	\$0.76	\$0.65
B 231008 ___	10.5 x 5 x 8.5 x 5	\$1.05	\$0.95	\$0.81



**07V - Gold**



**08V - Silver**

Estimated lead time: 2 - 3 weeks for printed items from approved art.



**FOIL PRINT**  
100+ 29¢ each  
1000+ 26¢ each  
2500+ 22¢ each



# IN STOCK

## Hinged Boxes

# IN STOCK

## Hinged Box



**COORDINATING EUROTOTE**  
See page 81

Available Color

Black Sleeve

### Glitter

Sparkle and shine with this great glittering series.

- White faux-suede pads and satin top liners
- Packaged in a black sleeve

CODE	DESCRIPTION	SIZE (inches)	PRICE /EACH	
			12+	144+
36221183	Ring	1.75 x 2 x 1.5	\$1.84	\$1.54
36222183	Earring	1.75 x 2 x 1.5	\$1.84	\$1.54
36284183	Utility T-pad	3.5 x 3.5 x 1.25	\$3.08	\$2.71
36293183	Bracelet	8.75 x 2.125 x 1	\$3.97	\$3.45
36273183	Necklace	6.25 x 4.25 x 1.25	\$5.05	\$4.37



**FOIL / PAD PRINT**  
12+ 29¢ each  
144+ 26¢ each  
504+ 22¢ each

Minimum 12 per style.  
Please allow 2 - 3 weeks for printed items from approved art.



### Sweetheart

Show the love with this sweet new velvet vintage inspired ring box.

- Velvet with satin top liner to put a small logo or icon
- Available in soft blush and three jewel tone colors
- Packaged in a 2-piece white outer box

CODE	DESCRIPTION	SIZE (inches)	PRICE /EACH		
			12+	144+	500+
36121 _ _ _	Ring	1.5 x 1.5 x 1.5	\$6.04	\$3.89	\$3.13

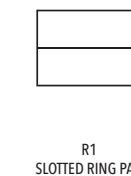

**FOIL / PAD PRINT**  
12+ 29¢ each  
144+ 26¢ each  
504+ 22¢ each

Minimum 12 per style.  
Please allow 2 - 3 weeks for printed items from approved art.



Available Colors

011B - Blush

561A - Amethyst

661B - Berry

251T - Teal



# IN STOCK

## Hinged Boxes

JEWELRY PACKAGING



**COORDINATING EUROTOTE**  
See page 81



### Jewelers Velvet

**Traditions endure.**

- Satin top liners
- Packaged in a white 2-piece outer box

CODE	DESCRIPTION	SIZE (inches)	PRICE /EACH	
			12+	144+
36121 ___	Ring	2 x 2.125 x 1.5	\$2.02	\$1.85
36141 ___	Large Ring	2.5 x 2 x 1.5	\$2.58	\$2.32
36122 ___	Earring	2 x 2.125 x 1.5	\$2.02	\$1.85
36132 ___	Utility T-pad	2.5 x 2.5 x 1.25	\$2.58	\$2.32
36163 ___	Pendant	2.25 x 3 x 1.125	\$2.58	\$2.32
36183 ___	Utility	3.5 x 3.375 x 1.5	\$4.09	\$3.67
36193 ___	Bracelet	8 x 2 x 1.25	\$4.22	\$3.81
36173 ___	Necklace	7 x 4.25 x 1.5	\$7.07	\$6.38
69221000B	Bead Pad for earring box		\$0.68	\$0.56



**Bead Pad**

- pad fits stud earring box
- ribbon threads through bead
- ribbon wraps to back and is held by clip

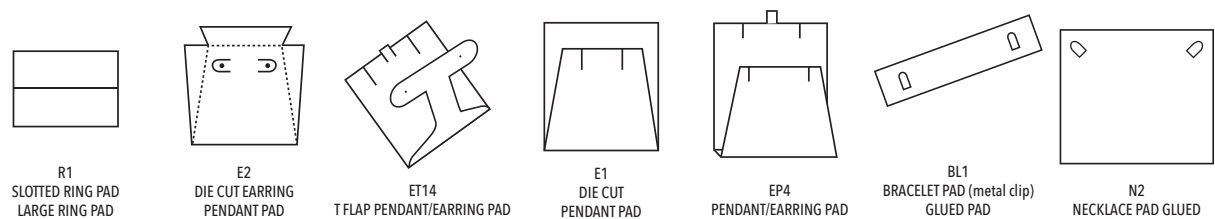

**FOIL / PAD PRINT**  
12+ 29¢ each  
144+ 26¢ each  
504+ 22¢ each

Minimum 12 per style.  
Please allow 2 - 3 weeks for printed items from approved art.



# IN STOCK

## Hinged Boxes

JEWELRY PACKAGING



**COORDINATING EUROTOTE**  
See page 81



**ADDITIONAL CHARGE FOR OPTIONAL 2-PIECE OUTER BOX**

### Econoline

**Lasting traditions in blue.**

- Blue velour exterior
- Matching interior with white satin
- Arrives in protective white sleeve
- Optional white gloss packer

CODE	DESCRIPTION	SIZE (inches)	PRICE /EACH		2-PIECE CONTAINER PRICE /EACH	
			12+	144+	31 ___ 003	
36121119	Ring	1.875 x 2.125 x 1.375	\$1.52	\$1.36	121	\$0.74
36141119	Large Ring	2.375 x 2 x 1.5	\$1.65	\$1.49	141	\$0.78
36122119	Earring	1.875 x 2.125 x 1.375	\$1.52	\$1.36	121	\$0.74
36163119	Pendant	2.25 x 3 x 1.125	\$2.07	\$1.85	163	\$0.81
36132119	T-pad Pendant	2.5 x 2.5 x 1.25	\$2.07	\$1.85	132	\$0.81
36193119	Bracelet	8 x 2.125 x 1	\$3.19	\$2.86	193	\$1.02
36173119	Necklace	7 x 4.25 x 1.375	\$5.41	\$4.88	173	\$1.48
36183119	Utility	3.875 x 3.25 x 1.375	\$3.19	\$2.86	183	\$1.11
69221000B	Bead Pad for earring box		\$0.68	\$0.56	--	



**Bead Pad**

- pad fits stud earring box
- ribbon threads through bead
- ribbon wraps to back and is held by clip

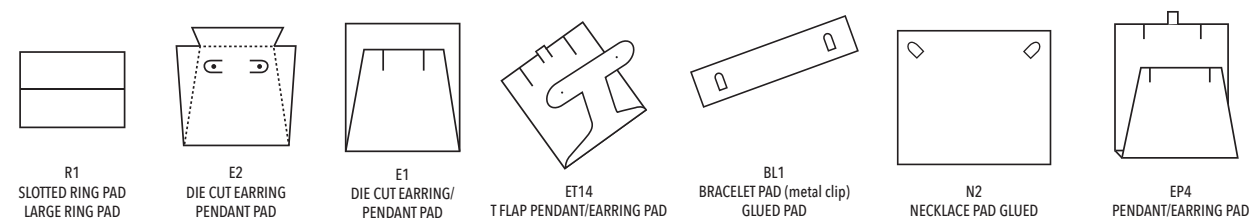

**FOIL / PAD PRINT**  
12+ 29¢ each  
144+ 26¢ each  
504+ 22¢ each

Minimum 12 per style.  
Please allow 2 - 3 weeks for printed items from approved art.





# IN STOCK

## Hinged Boxes



**COORDINATING EUROTOTE**  
See page 81

Available Color



Outer Box

### Elan

Timeless classic in all white.

- Soft, white leatherette covering
- Coordinating leatherette pads and white satin top liners
- Packaged in a white traditional 2-piece outer box

CODE	DESCRIPTION	SIZE (inches)	PRICE /EACH	
			12+	144+
36021002	Single Ring	2 x 2.25 x 1.625	\$2.93	\$2.64
36041002	Large Ring	3 x 2 x 1.5	\$3.51	\$3.15
36022002	Earring	2 x 2.25 x 1.5	\$2.93	\$2.64
36084002	Utility T-pad	3.5 x 3.5 x 1.375	\$5.21	\$4.60
36093002	Bracelet	8.625 x 2.25 x 1	\$5.13	\$4.61
36073002	Necklace	7.125 x 4.375 x 1.25	\$7.32	\$6.59



**FOIL / PAD PRINT**  
12+ 29¢ each  
144+ 26¢ each  
504+ 22¢ each

Minimum 12 per style.  
Please allow 2 - 3 weeks for printed items from approved art.



# IN STOCK

## Hinged Boxes



**COORDINATING EUROTOTE**  
See page 81

Available Color



Outer Sleeve

### Econolux

Style meets value.

- Soft, white leatherette covering
- White suedine pads and satin top liners
- Packaged in a white tuck outer box (2-piece traditional outer box available)

**ADDITIONAL CHARGE FOR OPTIONAL 2-PIECE OUTER BOX**

CODE	DESCRIPTION	SIZE (inches)	PRICE /EACH		2-PIECE CONTAINER PRICE /EACH	
			12+	144+	31	003
36121002	Ring	1.875 x 2.125 x 1.375	\$1.61	\$1.44	121	\$0.74
36141002	Large Ring	2.375 x 2 x 1.5	\$1.75	\$1.57	141	\$0.78
36122002	Earring	1.875 x 2.125 x 1.375	\$1.61	\$1.44	121	\$0.74
36163002	Pendant	2.25 x 3 x 1.125	\$2.19	\$1.97	163	\$0.81
36132002	T-pad Pendant	2.5 x 2.5 x 1.25	\$2.19	\$1.97	132	\$0.81
36193002	Bracelet	8 x 2.125 x 1	\$3.37	\$2.03	193	\$1.02
36173002	Necklace	7 x 4.25 x 1.375	\$5.72	\$5.15	173	\$1.48
36183002	Utility	3.875 x 3.25 x 1.375	\$3.37	\$3.03	183	\$1.11
69221000B	Bead Pad for earring box		\$0.68	\$0.56	--	--



### Bead Pad

- pad fits stud earring box
- ribbon threads through bead
- ribbon wraps to back and is held by clip

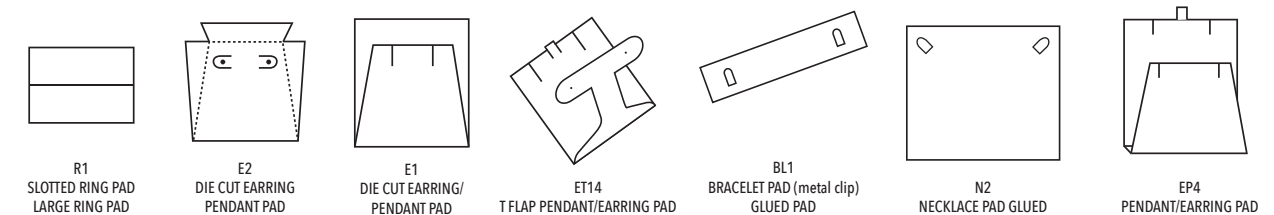

**FOIL / PAD PRINT**  
12+ 29¢ each  
144+ 26¢ each  
504+ 22¢ each

Minimum 12 per style.  
Please allow 2 - 3 weeks for printed items from approved art.





# IN STOCK

## Hinged Boxes

Deliver the 'in-store' experience to your customer's door. See page 109 for more information.

**COORDINATING EUROTOTE**  
See page 81



Available Color



### Bead Pad

- pad fits stud earring box
- ribbon threads through bead
- ribbon wraps to back and is held by clip

## Gold Galleria

A new gold standard.

- White velour pads and satin top liners
- Packaged in a white traditional 2-piece outer box

CODE	DESCRIPTION	SIZE (inches)	PRICE / EACH	
			12+	144+
36621073	Ring	2.125 x 2 x 2	\$2.09	\$1.88
36622073	Earring	2.125 x 2 x 2	\$2.09	\$1.88
36641073	Large Ring	3 x 2 x 2	\$2.47	\$2.22
36684073	Utility T-pad	3.5 x 3.5 x 1.5	\$3.31	\$2.84
36693073	Bracelet	8.25 x 2.125 x 1.25	\$4.57	\$4.12
36673073	Necklace	6.25 x 5 x 1.5	\$7.42	\$6.67
36650073	Bangle	1.25 x 3.75 x 3.125	\$3.57	\$3.23
69621000B	Bead Pad for earring box		\$0.65	\$0.54



**FOIL / PAD PRINT**  
12+ 29¢ each  
144+ 26¢ each  
504+ 22¢ each

Minimum 12 per style.  
Please allow 2 - 3 weeks for printed items from approved art.



## E-Commerce Jewelry Boxes

Deliver the 'in-store' experience to your customer's door. See page 109 for more information.

**COORDINATING EUROTOTE**  
See page 81



153B - Black Interior

## Horizon

The gold standard in a classic white, burgundy and black.

- White velour pads and satin top liners
- Packaged in a white traditional 2-piece outer box

CODE	DESCRIPTION	SIZE (inches)	PRICE / EACH	
			12+	144+
36621 ___	Ring	2.125 x 2 x 2	\$2.18	\$1.95
36622 ___	Earring	2.125 x 2 x 2	\$2.18	\$1.95
36641 ___	Large Ring	3 x 2 x 2	\$2.57	\$2.31
36684 ___	Utility T-pad	3.5 x 3.5 x 1.5	\$3.47	\$2.83
36632 ___	T-Pad Pendant	2.75 x 2.75 x 1.375	\$2.98	\$2.67
36693 ___	Bracelet	8.25 x 2.125 x 1.25	\$4.75	\$4.28
36673 ___	Necklace	6.25 x 5 x 1.5	\$7.72	\$6.94
36650 ___	Bangle	1 x 3.75 x 3.125	\$3.72	\$3.36
69621000B	Bead Pad for earring box		\$0.68	\$0.56
<b>BLACK PADS AVAILABLE (3 SIZES)</b>				
36621153B	Single Ring Pad (black)	2.125 X 2 box w/pad	\$2.02	\$1.81
69622153B	Stud Earring Pad (black)	2.125 x 2 pad only	\$0.27	\$0.27
69633153B	Pend/Earring Pad (black)	2.75 x 2.75 pad only	\$0.27	\$0.27



**FOIL / PAD PRINT**  
12+ 29¢ each  
144+ 26¢ each  
504+ 22¢ each

Minimum 12 per style.  
Please allow 2 - 3 weeks for printed items from approved art.



# IN STOCK

## Hinged Boxes

Available Colors



### Bead Pad

- pad fits stud earring box
- ribbon threads through bead
- ribbon wraps to back and is held by clip



# IN STOCK

## Jewelry Packaging



Available Colors



### Nano Clutch

Perfect for gifting and on the go, this collection is going places!

- Linea envelope, and pad
- Packaged in a 2-piece matching outer box

CODE	DESCRIPTION	SIZE (inches)	PRICE /EACH	
			12+	144+
09121_ _ _ _	Ring	2.55 X 2.55	\$1.95	\$1.79
09163_ _ _ _	Pendant	4 X 4	\$2.37	\$2.18
09193_ _ _ _	Bracelet	9.625 X 3.125	\$3.27	\$3.01
09173_ _ _ _	Necklace	6.625 X 6.625	\$4.48	\$4.12

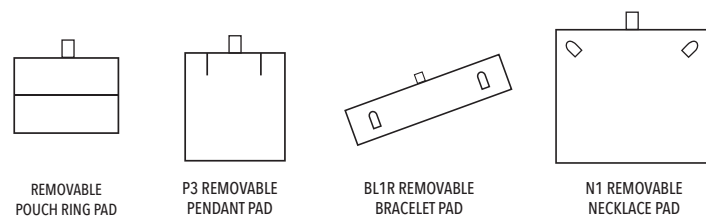

**FOIL / PAD PRINT**  
 12+ 29¢ each  
 144+ 26¢ each  
 504+ 22¢ each

Minimum 12 per style.  
 Please allow 2 - 3 weeks for printed items from approved art.



# IN STOCK

## Specialty



### The Drawer Box

Eco-friendly, on trend series.



- Fixed ring pad with foam
- Removable resuede recycled pads in Utility boxes
- Made with 100% recyclable Paper Board
- Coordinates with the Nano Pouch for a stunning reveal (earring & pendant)

CODE	DESCRIPTION	SIZE (inches)	CASE	PRICE /EACH	
				50+	500+
31050603	Ring	2.24 x 2.36 x 1.98	50	\$1.66	\$1.33
31070703	Utility/Earring	2.75 x 2.83 x 1.57	50	\$1.92	\$1.53
31101003	Utility/Pendant	3.93 x 4 x 1.57	50	\$2.50	\$2.00

Minimum one case pack.  
 Please allow 2 - 3 weeks for printed items from approved art.

**PAD PRINT**  
 50+ 29¢ each  
 500+ 22¢ each



### Vision Box

Unique transparent 3D window box with coordinating display stand.

- Transparent puncture resistant elastic film
- Conforms to hold any jewelry piece
- Coordinating display base (extra)

CODE	DESCRIPTION	SIZE (inches)	PRICE /EACH	
			12+	144+
36301103	Small	2.68 x 2.68 x .75	\$1.00	\$0.80
36302103	Medium	3.5 x 3.5 x .75	\$1.33	\$1.06
36303103	Large	4.25 x 4.25 x .75	\$1.66	\$1.33
69300103	Base (pkg of 12)	2.25 x 2.25 x .62	\$0.99	\$0.73

**PAD PRINT**  
 12+ 29¢ each  
 144+ 26¢ each  
 504+ 22¢ each

Minimum 12 per style.  
 Please allow 2 - 3 weeks for printed items from approved art.





# CREATE YOUR OWN LOOK

JEWELRY PACKAGING



## PAPERBOARD SERIES

Stylised lines and the geometric pattern gives this collection an art deco feel.

Create Your Own Look Paperboard Series Programs start at \$0.99 for the ring box  
See page 52.

# IN STOCK

## Paperboard Hinged

JEWELRY PACKAGING



**COORDINATING  
EUROTOTE**  
See page 81



Pads are removable and reversible. Choose white flock or black flock.



Recycled Paperboard

## Deco

Iconic black and white.

- Paperboard construction, covered in smooth laminate paper
- Flocked reversible black and white foam pads
- Packaged in individual white sleeves

CODE	DESCRIPTION	SIZE (inches)	CASE	PRICE /EACH	
				50+	500+
31621153D	Ring	2 x 2 x 1	50	\$1.08	\$0.99
31622153D	Earring	2 x 2 x 1	50	\$1.08	\$0.99
31632153D	Large Earring	2.5 x 2.5 x 1.75	50	\$1.39	\$1.28
31684153D	Utility	3.75 x 3.75 x 1.5	50	\$2.23	\$2.05
31693153D	Bracelet	9 x 2 x 1,125	50	\$2.32	\$2.13
31673153D	Necklace	6.5 x 8 x 2	50	\$5.57	\$5.12

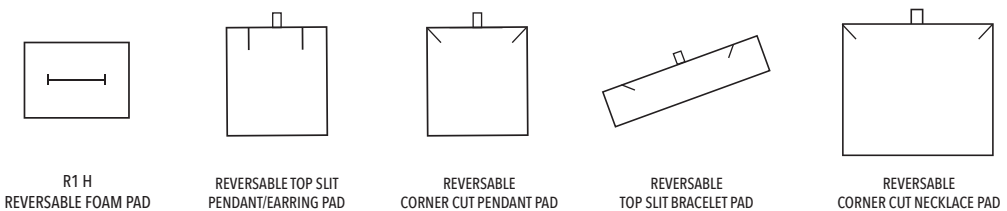

**FOIL / PAD PRINT**  
50+ 29¢ each  
500+ 22¢ each

Minimum one case pack.  
Please allow 2 - 3 weeks for printed items from approved art.

All print orders subject to set-up charges. Applicable artwork, and plate charges may apply. See page 130.



# IN STOCK

## 2-Piece Boxes

**COORDINATING EUROTOTE**  
See page 80



### E-Commerce Jewelry Boxes

Deliver the 'in-store' experience to your customer's door



See page 109 for more information

## Velocity

Organza ribbon and classic boxes make for perfect partners.

- Exterior embossed paper, interior flocked white foam
- Bronze coordinates with our Bronze Geo series and Geo eurotote
- Coordinating ribbon

CODE	DESCRIPTION	SIZE (inches)	CASE	PRICE/EACH	
				25+	1000+
31221 ___	Ring	2.5 x 2.25 x 2	50	\$1.59	\$1.36
31283 ___	Utility	3 x 3 x 2	50	\$2.22	\$1.91
31293 ___	Bracelet	9 x 2.25 x 1.5	25	\$3.04	\$2.61
31273 ___	Necklace	6.25 x 8 x 2	25	\$4.00	\$3.61

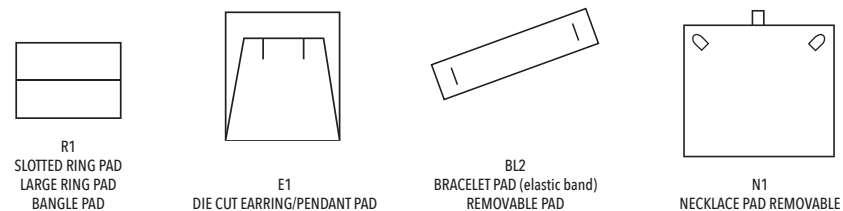

**FOIL / PAD PRINT**  
25/50+ 29¢ each  
1000+ 26¢ each  
2500+ 22¢ each  
Minimum one case pack.  
Please allow 2 - 3 weeks for printed items from approved art.



# IN STOCK

## 2-Piece Boxes

**NEW! COORDINATING ALL PAPER EUROTOTE**  
See page 83



## Romance

Perfect partners in ivory and gold.

- Embossed ivory paper with just the right amount of gold reveal
- Includes coordinating ribbon to add the perfect bow
- White velour pads
- Arrives in protective sleeve
- Imprint top of box or interior lid
- Our cream all paper eurotote will complete the look

CODE	DESCRIPTION	SIZE (inches)	CASE	PRICE/EACH	
				50+	1000+
31221863	Ring	2.5 x 2.25 x 2	100	\$1.46	\$1.38
31222863	Earring	2 x 1.5 x 1.187	100	\$1.39	\$1.24
31263863	Utility	3 x 3 x 2.125	100	\$1.64	\$1.50
31293863	Bracelet	9 x 2.375 x 1.5	50	\$2.40	\$2.13
31273863	Necklace	6.375 x 8 x 2	50	\$3.16	\$2.91

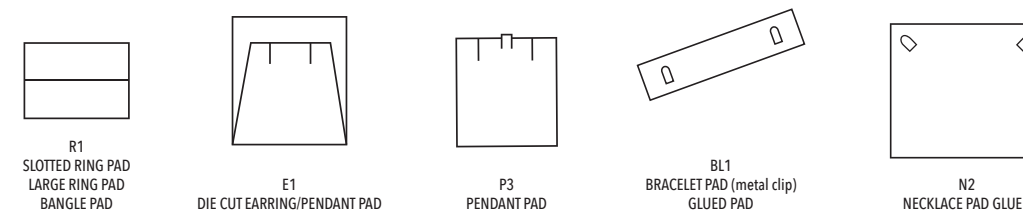

**FOIL / PAD PRINT**  
50/100+ 29¢ each  
1000+ 26¢ each  
2500+ 22¢ each  
Minimum one case pack.  
Please allow 2 - 3 weeks for printed items from approved art.





# IN STOCK

## 2-Piece Boxes

JEWELRY PACKAGING



**COORDINATING  
EUROTOTE**  
See pages 80-81

### Shadow

Shimmery grey exterior, featuring a wave reveal.

- White flocked foam pads
- No packer/no sleeve

CODE	DESCRIPTION	SIZE (inches)	CASE	PRICE/EACH	
				50+	1000+
31511308	Charm	2 x 2 x 1	100	\$0.99	\$0.95
31521308	Ring/Earring	2 x 2 x 1.75	100	\$1.06	\$1.00
31563308	Pendant/Earring	3.5 x 3.5 x 1.25	50	\$1.48	\$1.38
31593308	Bracelet	9 x 2 x 1	50	\$2.15	\$2.03
31573308	Necklace	6 x 6 x 1.5	50	\$2.64	\$2.61

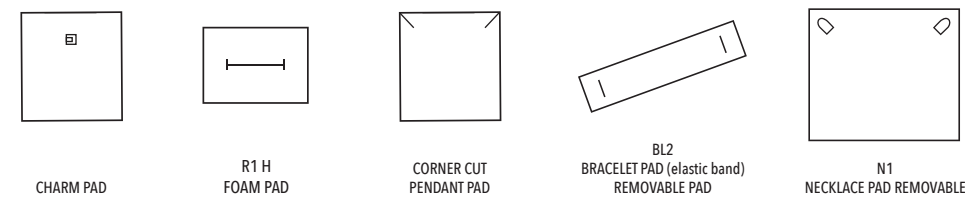

**FOIL / PAD PRINT**  
 50/100+ 29¢ each  
 1000+ 26¢ each  
 2500+ 22¢ each

Minimum one case pack.  
 Please allow 2 - 3 weeks for printed items from approved art.



See page 52.

# IN STOCK

## Paperboard Hinged

JEWELRY PACKAGING



**COORDINATING  
EUROTOTE**  
See pages 80-81

### Royale

Hinged, white paperboard boxes covered in finely ribbed paper with gold accent lines.

- White flocked foam pads
- Imprint available inside or on top of lid
- No packer/no sleeve

CODE	DESCRIPTION	SIZE (inches)	CASE	PRICE/EACH	
				50+	1000+
31545003	Ring/Earring	2.5 x 2 x 1.5	100	\$0.73	\$0.69
31533003	Pendant/Earring	2.75 x 2.75 x 1	100	\$0.88	\$0.81
31560003	Utility	3.5 x 3.5 x 1	50	\$1.31	\$1.24
31580003	Bracelet	8.125 x 2.125 x 1	50	\$1.76	\$1.65
31575003	Necklace	6.5 x 4.5 x 1	50	\$2.49	\$2.34

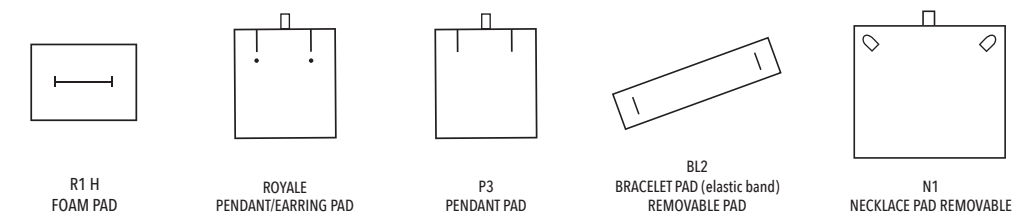

**FOIL / PAD PRINT**  
 50/100+ 29¢ each  
 1000+ 26¢ each  
 2500+ 22¢ each

Minimum one case pack.  
 Please allow 2 - 3 weeks for printed items from approved art.



See page 52.

All print orders subject to set-up charges. Applicable artwork, and plate charges may apply. See page 130.

All print orders subject to set-up charges. Applicable artwork, and plate charges may apply. See page 130.



# SPECIAL ORDER

## Nest Boxes



100% Recycled Board

**COORDINATING PAPER SHOPPER**  
See page 92



Available Colors



## Berkeley

Simple yet striking keyline design collection.

- Gloss paper
- Fully customizable
- White flocked platform inserts

CODE	SIZE (inches)	CASE	PRICE/EACH	
			100+	1000+
32201 ___	3 x 3 x 1.25	100	\$1.50	\$1.37
32202 ___	3.5 x 3.5 x 2	100	\$1.65	\$1.51
32203 ___	5 x 5 x 1.5	100	\$2.04	\$1.87
32204 ___	9 x 4.5 x 2	100	\$2.71	\$2.48

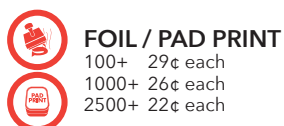

**FOIL / PAD PRINT**  
100+ 29¢ each  
1000+ 26¢ each  
2500+ 22¢ each

Minimum one case pack.  
Estimated lead time - Please allow 3 weeks for unprinted items and 4 weeks for printed items from approved art.

# SPECIAL ORDER

## Nest Boxes



100% Recycled Board



Available Colors

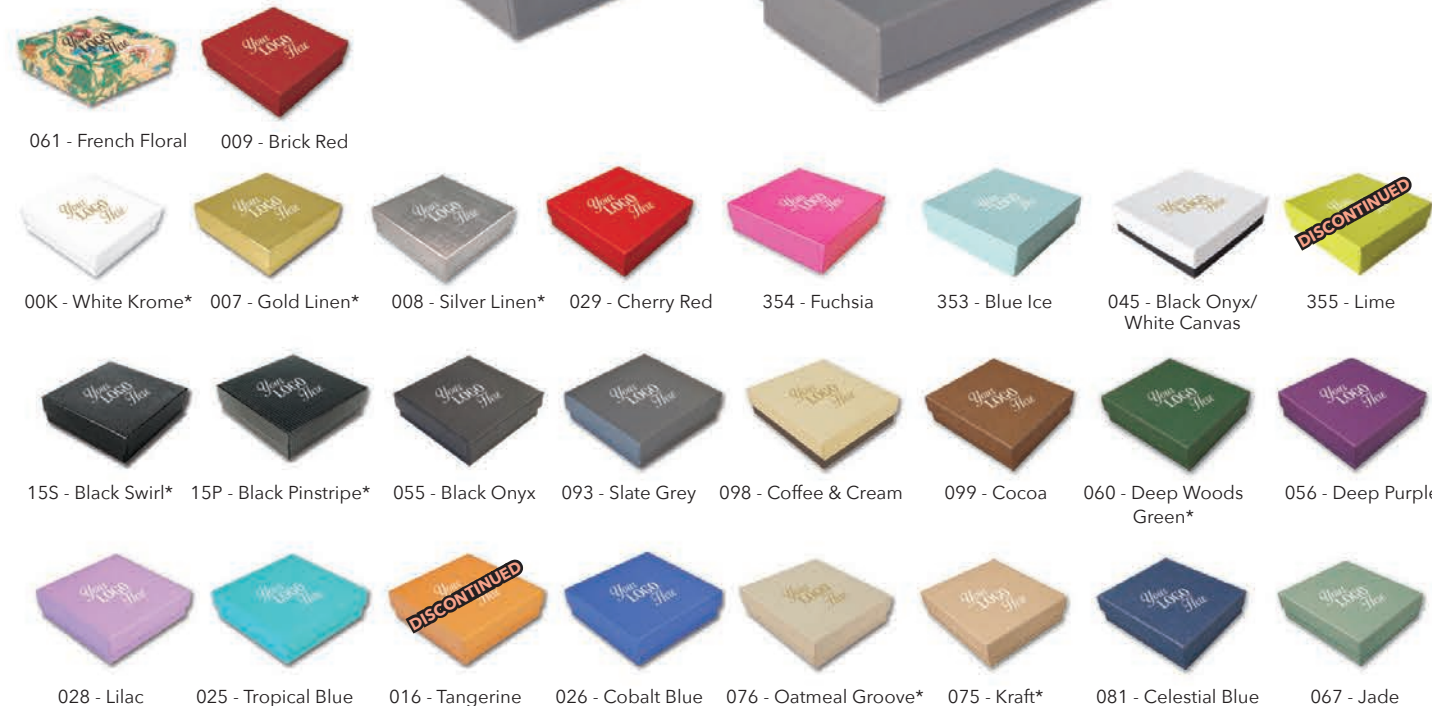

### ECO-FRIENDLY



019 - White Sand 020 - Moss



+ FSC paper wraps.

Minimum one case pack.  
Estimated lead time - Please allow 3 weeks for unprinted items and 4 weeks for printed items from approved art.

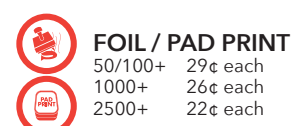

**FOIL / PAD PRINT**  
50/100+ 29¢ each  
1000+ 26¢ each  
2500+ 22¢ each

## Cotton Filled Nest Boxes

CODE	SIZE (inches)	CASE PACK	SOLID COLOR & ECO-FRIENDLY PRICE/EACH	
			50+	1000+
* 31011 ___	1.75 x 1.125 x .625	100	\$0.48	\$0.38
31021 ___	2.5 x 1.5 x .875	100	\$0.52	\$0.41
31032 ___	3 x 2.125 X 1	100	\$0.55	\$0.42
31033 ___	3.5 x 3.5 x 1	100	\$0.66	\$0.50
o 31036 ___	3.5 x 3.5 x 1.5	100	\$0.70	\$0.56
31034 ___	3.5 x 3.5 x 2	100	\$0.74	\$0.59
31053 ___	5.25 x 3.75 x .875	100	\$0.80	\$0.61
o 31065 ___	6 x 5 x 1	50	\$1.07	\$0.83
o 31082 ___	8 x 2 x .875	100	\$0.70	\$0.56
** 31085 ___	8 x 5.5 x 1.25	50	\$1.42	\$1.12

\* These sizes are available in these colors only: 00K, 007, 15P, 060, 075, 076, 008, 15S.

+ All colors available except for: 008, 15S.

o These sizes have limited colors available.

All print orders subject to set-up charges. Applicable artwork, and plate charges may apply. See page 130.

All print orders subject to set-up charges. Applicable artwork, and plate charges may apply. See page 130.



# IN STOCK

## Nest Boxes



These boxes match our **Damask Paper Shoppers** - page 93 and **Damask Pouches** - page 56

## Damask

Style and substance in a single packaging combination.

- Black and White 2-piece box
- 100% recycled board box
- Cotton fill pad wrapped with damask patterned tissue
- See our matching bag and pouch to complete your collection

CODE	DESCRIPTION	SIZE (inches)	CASE PACK	PRICE/EACH	
				100+	1000+
31570153D	Earring	3 x 2.125 x 1	100	\$0.55	\$0.53
31555153D	Brooch	3.5 x 3.5 x 1	100	\$0.67	\$0.64
31564153D	Bracelet	8 x 2 x .875	100	\$0.79	\$0.76
31558153D	Necklace	6 x 5 x 1	100	\$1.14	\$1.10

Minimum order is one case pack.

White Swirl Pattern



## White Economy

Sometimes a simple box is all you need!

- Made with 100% recycled board covered with white swirl paper
- Cotton filled to hold jewelry in place

CODE	DESCRIPTION	SIZE (inches)	CASE PACK	PRICE/EACH	
				50+	1000+
31502103	Charm	2.5 x 1.5 x .875	100	\$0.35	\$0.32
31570103	Earring	3 x 2.125 x 1	100	\$0.37	\$0.33
31555103	Brooch	3.5 x 3.5 x 1	100	\$0.42	\$0.39
31564103	Bracelet	8 x 2 x .875	100	\$0.46	\$0.44
31558103	Necklace	6 x 5 x 1	50	\$0.72	\$0.68
31576103	Large Necklace	8 x 5.5 x 1.25	50	\$1.20	\$1.13
31259103	Stand-Up Bangle	3.5 x 2 x 2 x 2	100	\$1.88	\$1.69

Minimum order is one case pack.



100% Recycled Board



**FOIL / PAD PRINT**  
100+ 29¢ each  
1000+ 26¢ each  
2500+ 22¢ each

Estimated lead time: 2 - 3 weeks for printed items from approved art.



100% Recycled Board



**FOIL / PAD PRINT**  
50/100+ 29¢ each  
1000+ 26¢ each  
2500+ 22¢ each

Estimated lead time: 2 - 3 weeks for printed items from approved art.

# IN STOCK

## Jewelry Folders

### Passport Jewelry Folders

Designed with stylish envelope closure, snaps tight to keep jewels secure.

- Linea exteriors, satin interior
- Packaged in a 2-piece white outer box
- Two colors soft white and black



CODE	DESCRIPTION	SIZE (inches)	PRICE/EACH	
			12+	144+
367950	Bracelet	8.25 x 1.75	\$3.80	\$3.43
367900	Necklace/Pearl	6 x 8	\$6.04	\$5.44



**FOIL / PAD PRINT**  
12+ 29¢ each  
144+ 26¢ each  
504+ 22¢ each

Estimated lead time: 2 - 3 weeks for printed items from approved art.



### Global Jewelry Folders

Wide gusset folder for larger pieces.

- Bronze and pearl linea
- Black faux suede
- Satin interior and magnetic closure
- Packaged in a 2-piece matching outer box

CODE	SIZE (in.)	PRICE /EACH	
		12+	144+
36790	5.5 x 7.5	\$8.48	\$7.45



**FOIL / PAD PRINT**  
12+ 29¢ each  
144+ 26¢ each  
504+ 22¢ each

Estimated lead time: 2 - 3 weeks for printed items from approved art.

### Hoop Earring Folder

Black ultrasuede folder with top stitch finish and black interior. Holds hoop earrings up to 2.75" in diameter.

- Packaged in a white 2-piece outer box
- Case pack of 12



**FOIL PRINT**  
12+ 29¢ each  
144+ 26¢ each  
504+ 22¢ each

CODE	SIZE (in.)	PRICE /EACH	
		12+	144+
36791015	4.5 x 4.5	\$3.62	\$3.13

All print orders subject to set-up charges. Applicable artwork, and plate charges may apply. See page 130.



# CREATE YOUR OWN LOOK

## TELL YOUR BRAND STORY CREATE YOUR UNIQUE IDENTITY



Create Your Own Look  
in 7 Easy Steps

Speak to your  
sales representative  
for a consultation.

### Looking for 100% custom design? Design your very own jewelry packaging.

#### STEP 1:

##### Choose your box style.

We have access to endless design and looks. You dream it, we can create it.

Choose from wood, plastic, MDF and paperboard shells. Select hinged or 2-piece.

MOQ:

Plastic or Metal 2,500

Wood 1,000

Paperboard 5,000

#### STEP 2:

##### Choose your covering and color.

Leatherette, velvet, paper.

Design your texture—hundreds to choose from, or create your own. Brushed leatherette, embossed papers, smooth, textured, Select from our color books, or use Pantone to specify your exact colors.

#### STEP 3:

##### Specify the interior.

Select pad color and material for inside lid.

Leatherette, brushed leatherette, flocked, velvet, velour.

Decide on the top interior material—leatherette, brushed leatherette, satin, flocked, velvet.

Select color—white, black, ivory are most common.

Option—create a reveal with contrasting color.

#### STEP 4:

##### Design your packer.

2-piece box or sleeve.

Often you can use the same material or create a coordinating color.

Option -- add die cuts at bottom for ribbon, and/or reveal for contrasting color.



#### STEP 5:

##### Design logo placement.

Areas to consider:

Inside box lid (Top Satin)

Packer Lid (can be centered, or placed at lower corner if using ribbon)

Top Lid



#### STEP 6:

Select your pad designs. (See page 53)

#### STEP 7:

##### Email your artwork.

Artwork ultimately needs to be in Vector file format. Your graphic designers should be able to assist you. Gunther Mele is also available to provide artwork assistance and full service design, cost is \$75/hour, min half hour charge.

CYOL has 16-20 weeks lead time. (Time frames based on signed approved artwork, quote and deposit).

Printing and pre-production samples included at no extra charge.

##### Please note:

Logos with intricate lines and details (such as diamonds), often will not translate in small print areas, such as top satins. Designs with text and simple outlines work best for inside of ring boxes, etc. Reps and our designers will advise you when artwork should be modified to produce best results.

To ensure accuracy and best quality, signatures are required on all artwork documents and quote documents where noted. Production will not commence until all artwork, quotes and deposits are finalized and signed off. Your rep is available to work with you to ensure all documentation is completed to prevent delays. Please ensure your email access is update date.

### Complete your look!

Bags, Tissue, Pouches, Ribbon, Displays, Necklace folders, and more!

Select from our in stock or create your own. Gunther Mele is your one stop for all your needs.

Our sales representative can help you design all your packaging and displays to tell your unique brand story.

# CREATE YOUR OWN LOOK

#### RING PADS

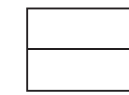

R1  
SLOTTED PAD

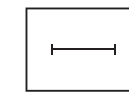

R1 H  
FOAM PAD

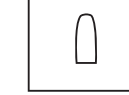

R2  
EUROPEAN STYLE  
CLIP PAD

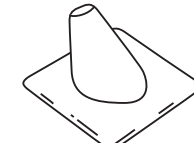

R4  
FINGER



R1 8  
RING ROLL

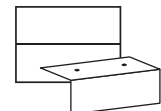

2-PIECE EARRING /  
R1 SLOTTED RING PAD

#### EARRING PADS

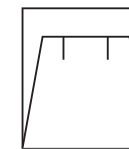

E1  
DIE CUT  
EARRING/PENDANT  
PAD

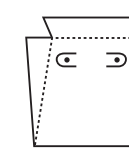

E2  
DIE CUT  
EARRING/PENDANT  
PAD

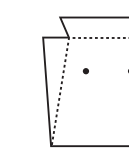

E3  
DIE CUT  
EARRING/PENDANT  
PAD



EP4  
EARRING/PENDANT  
PAD

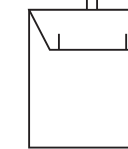

E4 SLITS  
EARRING PAD

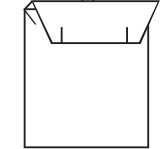

E8  
LEVER BACK  
EARRING PAD

#### EARRING/PENDANT PADS

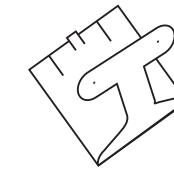

ET14  
T FLAP  
PENDANT/EARRING PAD

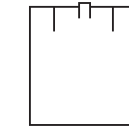

P3  
PENDANT PAD

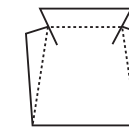

P5  
DIE CUT  
PENDANT PAD

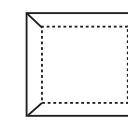

U1  
DIE CUT  
WELL PAD

#### BRACELET AND WATCH PADS

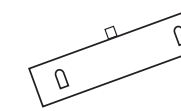

BL1R  
REMOVABLE  
BRACELET PAD

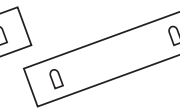

BL1  
BRACELET PAD  
(metal clip)  
GLUED PAD

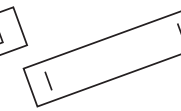

BL2  
BRACELET PAD  
(elastic band)  
GLUED PAD

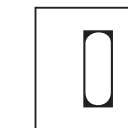

W1  
DIE CUT  
(removable metal collar)



W3  
DIE CUT  
(metal "C")

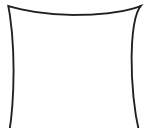

PL1  
PILLOW

#### NECKLACE PADS AND TRIPLE FLIP PADS

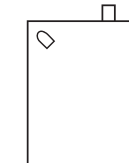

N1  
REMOVABLE  
NECKLACE PAD

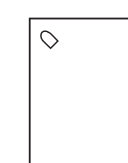

N2  
NECKLACE PAD  
GLUED

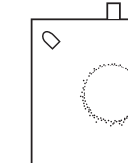

N3  
REMOVABLE  
NECKLACE PAD

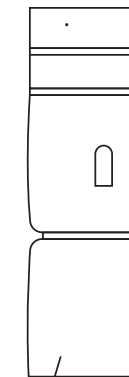

T1  
TRIPLE FLIP  
RING/PENDANT/EARRING PAD



T2  
TRIPLE FLIP  
PENDANT/EARRING PAD



# IN STOCK

## Gift Card Boxes



Gift Cards  
Not Included.

### Black Gift Card Box with Ribbon

Estimated lead time: 2 - 3 weeks for printed items from approved art.  
Minimum order is one case pack.

CODE	SIZE (inches)	CASE	PRICE/EACH		FOIL / PAD PRINT
			100+	1000+	
31040315	4 x 3 x .625	100	\$1.53	\$1.19	100+ 29¢ each 1000+ 26¢ each 2500+ 22¢ each

### Pewter Gift Card Box with Ribbon

Estimated lead time: 2 - 3 weeks for printed items from approved art.  
Minimum order is one case pack.

CODE	SIZE (inches)	CASE	PRICE/EACH		FOIL / PAD PRINT
			50+	1000+	
31040742	7.5 x 4.25 x .625	50	\$2.19	\$1.97	50+ 29¢ each 1000+ 26¢ each 2500+ 22¢ each

### Gift Certificate and Box

Estimated lead time: 2 - 3 weeks for printed items from approved art.

CODE	SIZE (inches)	CASE	PRICE/EACH
			100+
09221001B	Ivory Gift Certificate Box Only	100	\$0.82
18199	Generic Gift Certificate Only 6.375 x 3.125" folded	100	\$0.57

Minimum order is one case pack.

Interior of gift certificate shows print-ability and are numbered.

FRENCH VERSION AVAILABLE

FOIL / PAD PRINT



Sold  
separately.

FRONT



# SPECIAL ORDER

## Gift Card Boxes

Estimated lead time: 3 weeks for unprinted items and 4 weeks for printed items from approved art.



Gift Cards  
Not Included.

### Magnetic Gift Card Box

People love gift cards, this box takes the presentation to a new level.

- Smooth paper hinged box with magnetic closure
- Removable insert to hold card, just slide in place for secure hold
- Try 15-black with our clear black gloss print GL2

CODE	SIZE (inches)	CASE	PRICE/EACH
			100+
310239 _ _	5.125 x 4 x 1	100	\$1.59

FOIL / PAD PRINT

Estimated lead time: 3 weeks for unprinted items and 4 weeks for printed items from approved art.

### Gift Card Nest Box

- White paperboard platforms
- Interior has same paper for lids and bases

CODE	SIZE (inches)	CASE	PRICE/EACH
			100+
313230 _ _	3.5 x 2.25 x .75	100	\$0.70

Estimated lead time: 3 weeks for unprinted items and 4 weeks for printed items from approved art.

### Gift Certificate Box

CODE	SIZE (inches)	CASE	PRICE/EACH
			100+
0922100 _ B	Gift Certificate Box Only see color options 6.625 x 3.25 x .5	100	\$1.23

Gift Certificate Box Color:

2	3	4
WHITE	GOLD	SILVER

FOIL / PAD PRINT

Minimum order is one case pack.

## IN STOCK Finishing Touches

Available to finish the look of your gift certificate/card.

### Stretch Loops (100 pack min.)

09500607 6"	Gold	\$0.122/ea
09500608 6"	Silver	\$0.122/ea
09501007 10"	Gold	\$0.130/ea
09501008 10"	Silver	\$0.130/ea



Dress it up with printed ribbon!  
See page 122.





# IN STOCK

## Pouches

### Microfiber Pouches

• Minimum case pack 100.

CODE	COLOR	SIZE (inches)	PRICE /EACH	
			100+	500+
09040315	Black	4 x 3	\$0.99	\$0.84
09050415	Black	5-1/2 x 4	\$1.39	\$1.19
09040311	Blue	4 x 3	\$0.99	\$0.84
09050411	Blue	5-1/2 x 4	\$1.39	\$1.19



# IN STOCK

## Pouches

### Geo Series

• Minimum case pack 12

Estimated lead time: 2 - 3 weeks for printed items from approved art.



CODE	TYPE	SIZE (in.)	PRICE /EACH	
			12+	144+
A 09030415B	Geo Pouch with Black Box	3 x 4	\$1.88	\$1.58
B 09030456P	Geo Pouch with Purple Box	3 x 4	\$1.88	\$1.58
C 09030427T	Geo Pouch with Bronze Box	3 x 4	\$1.88	\$1.58

**FOIL / PAD PRINT**  
 12+ 29¢ each  
 144+ 26¢ each  
 504+ 22¢ each

JEWELRY PACKAGING

JEWELRY PACKAGING

### Damask Pouches



Zippered section

### Envelope Pouches with snap closure



Available in black. Packaged in a 2-piece, pearlized, dark grey outer box.



### Microfiber Bell Pouches \*

• Minimum case pack of 12



# SPECIAL ORDER

## Natural Jute and Natural Cotton Pouches

• Minimum 100 per size

Estimated lead time: 6 weeks for printed items from approved art.



**FOIL PRINT**  
 100+ 29¢ each  
 1000+ 26¢ each  
 2500+ 22¢ each

### Natural Cotton - FOIL PRINT ONLY

CODE	SIZE (in.)	PRICE /EACH	
		100+	1000+
09030400NC	3 x 4	\$0.45	\$0.37
09050600NC	5 x 6	\$0.65	\$0.53
09061000NC	6 x 10	\$0.97	\$0.79
09081200NC	8 x 12	\$1.29	\$1.06

### Natural Jute - NO PRINT

CODE	SIZE (in.)	PRICE /EACH	
		100+	1000+
09050500NJ	3 x 5 1/2	\$0.84	\$0.69
09050600NJ	5 x 6	\$1.00	\$0.82
09061000NJ	6 x 10	\$1.33	\$1.08

### White Leatherette Pouches



### Gold Metallic Pouches



• Minimum case pack of 100.

### Velveteen Pouches



- Black - 615
- Royal Blue - 611
- Brown - 612
- Green - 667
- Burgundy - 666

\*\*See chart for 2-piece SPECIAL ORDER outer box for the Velveteen pouches.



### Wedding Pouches \*

• Minimum case pack of 12



White satin pouch with a white 2-piece outer box.



### Reversible Pouch \*

• Minimum case pack 12



Foil print on top of the lid. Matching 2-piece printable outer box. Pouch has round base 2.75" Dia. x 3"H

### Economical packaging for inexpensive items or repairs.

Estimated lead time: 2 - 3 weeks for printed items from approved art.

**FOIL / PAD PRINT**  
 100+ 29¢ each  
 1000+ 26¢ each  
 2500+ 22¢ each

Bell Pouches, Wedding and Reversible Pouch minimums:

**FOIL / PAD PRINT**  
 12+ 29¢ each  
 144+ 26¢ each  
 504+ 22¢ each

CODE	TYPE	SIZE (inches)	PRICE /EACH	
			100+	1000+
A 09040515D	Large Damask Pouch	5.5 x 4	\$1.52	\$1.32
B 09030315D	Small Damask Pouch	3 x 3	\$1.11	\$1.01
C 09304715	Large Envelope Pouch	3 x 4	\$1.99	\$1.89
D 09203715	Small Envelope Pouch	2.375 x 2.75	\$1.54	\$1.42
E 09525115B	Large Microfiber Bell Pouch	4.375 x 5.375	\$1.08	\$0.92
F 09324115B	Small Microfiber Bell Pouch	3.25 x 4.5	\$0.82	\$0.71
G 09314700	Large White Leatherette Pouch	3 x 4	\$0.59	\$0.50
H 09203700	Small White Leatherette Pouch	2.75 x 3.25	\$0.48	\$0.42
I 09314807	Gold Metallic Pouch	3 x 4	\$0.55	\$0.43
J 09405 ___	*Velveteen Pouches	4 x 5.5	\$0.45	\$0.37
K 09314 ___	*Velveteen Pouches	3 x 4	\$0.37	\$0.31
31314003	White 2-piece outer box**	3.25 x 4.25	\$0.46	-
31541003	White 2-piece outer box**	4.5 x 6	\$0.52	-
L 37501006	White Wedding Pouches	1.875 x 2.5	\$1.84	\$1.54
M 09020315B	Satin Reversible Pouch Charcoal/Silver with packer	2.75 x 3	\$2.34	\$1.99

\* See photo for color code

All print orders subject to set-up charges. Applicable artwork, and plate charges may apply. See page 130.

## Organza

Organza Colors (Not exactly as shown.)

- Black - 030
- Hunter - 589
- Lt. Blue - 305
- Purple - 465
- Orange - 750
- Red - 250
- Baby Maize - 617
- Pastel Green - 513
- Turquoise - 340
- Silver - 012
- Navy - 370
- Burgundy - 276
- Lavender - 430
- Olive - 563
- Pink - 115
- Ivory - 810
- Fruit Punch - 155
- Royal - 350
- White - 029
- Smoke Blue - 337
- Ultra Violet - 467
- Copper - 073
- Mint - 530
- Gold - 690
- Mauve - 161
- Yellow - 645
- Fuchsia - 187

A is only available in Silver, White, Pink, Lavender, Gold and Ivory.

F not available in Fruit Punch, Orange, Royal, Turquoise and Yellow.

G is only available in Silver, White, Pink, Red, Burgundy, Lt. Blue, Royal, Lavender, Mint, Olive, Gold and Ivory.

CODE	SIZE (inches)	PRICE /EACH	
		100+	1000+
A 09905 ___	2 x 2.5	\$0.32	\$0.25
B 09910 ___	3 x 4	\$0.34	\$0.26
C 09915 ___	4 x 5.5	\$0.44	\$0.35
D 09920 ___	5 x 6.5	\$0.50	\$0.40
E 09925 ___	5.5 x 9	\$0.73	\$0.59
F 09930 ___	6 x 14	\$0.85	\$0.68
G 09950 ___	22 x 25 (not shown)	\$2.89	\$2.31

Minimum 100 per size/color.

Estimated lead time: 6 weeks for printed items from approved art. Can be foil printed.

**FOIL**  
 100+ 29¢ each  
 1000+ 26¢ each  
 2500+ 22¢ each



All print orders subject to set-up charges. Applicable artwork, and plate charges may apply. See page 130.



# IN STOCK

## Jewelry Care

Available for immediate shipment.



**Blitz™ - Ultra Sonic Machine** with non toxic Gem & Jewelry concentrate and microfibre polishing cloth. Single tank, battery operated unit (4 AA batteries not included). Place jewelry in baskets and immerse into tank, switch on for a 3 - 5 minute cleaning.

Ideal for cleaning Gold, Platinum, Diamonds, Ruby, Sapphire, Topaz, Amethyst, Aquamarine, Garnet, Peridot and other non-porous gems and non glued gems.

**04201600** \$24.00 each



### Blitz™ - Ultra Sonic Machine Gem & Jewelry Concentrate

Non toxic. Ideal for cleaning Gold, Platinum, Diamonds, Ruby, Sapphire, Topaz, Amethyst, Aquamarine, Garnet, Peridot and other non-porous gems and non glued gems.

**04201600C** \$1.39 each

Minimum order is 12-pieces.



**Gem & Jewelry Cleaner** is ideal for cleaning Gold, Platinum, Diamonds, Ruby, Sapphire, Topaz, Amethyst, Aquamarine, Garnet, Peridot and other non-porous gems.

**24 per case pack**  
**04651000** \$1.99 each  
8 oz.



**Foamz™** is the same Gem and Jewelry Cleaner that you have used and trusted for decades in an easy-to-use foam. Foamz™ is formulated to clean and restore Diamonds and other precious gemstone jewelry to their original brilliance.

**12 per case pack**  
**04657000** \$4.16 each  
2.5 oz.



**Silver Shine** is designed to remove tarnish from silver jewelry in seconds by utilizing a revolutionary new electrochemical process and is packaged in a wide mouth jar to easily clean larger pieces of silver jewelry.

**12 per case pack**  
**04681000**  
\$4.70 each  
3 trays



**Silver Care Polish** traditional, non-abrasive, silver polishing cream  
**12 per case pack**  
**04618000**  
\$3.65 each  
8 oz.



**Delicate Gem & Pearl Cleaner** is formulated to gently clean and restore the luster to Emerald, Ivory, Onyx, Opal, Pearl, Turquoise, Lapis, Coral, Malachite and other porous gems.

**24 per case pack**  
**04671000** \$1.99 each  
8 oz.



**Watch Care Kit** cleans and polishes all watches and bands (gold, silver, stainless steel or leather).

**12 per case pack**  
**04620462** \$10.34/ea



### Gem & Jewelry Cleaner Concentrate

A) One gallon 10:1  
**04654000** \$18.85/ea  
B) 8 fl. oz. 5:1  
**04653000** \$3.09/ea



### Jewelry Care Cloth

11" x 14" two ply cloth made from 100% soft cotton. The interior is thoroughly treated with the finest cleaning and polishing agents with tarnish inhibitors to clean, shine and protect.

**12 per case pack**  
**04961700 Jewelry Care**  
\$3.95/ea

**04961800 Silver Care**  
\$3.95/ea



## Handling Gloves

White microfibre  
One size fits all

The natural oils in our skin can often leave displeasing marks on jewelry. Our microfibre, lint-free gloves are ideal for handling and protecting your most precious inventory.

**05000296**  
**\$2.50/pair**  
minimum order - 6 pairs

# SPECIAL ORDER

## Jewelry Care

See information below for estimated lead times.

## Full Color Printed Labels

Customize with your store brand!  
**144 - 236ml Jars for just \$1.99 each**

Create your own full color look.  
Estimated lead time: 6 - 8 weeks for custom printed items from approved art.  
Minimum order is 144 jars.



Background and this area is customizable!



Samples of full color labels

CODE	DESCRIPTION	PRICE/EACH
04651000C	Private Label Gem Jewel Cleaner	\$1.99

## Full Color Microfiber Cleaning Cloths

Estimated lead time: 6 - 8 weeks for printed items from approved art.  
Minimum order is 2500 cloths.

CODE	SIZE (inches)	PRICE/EACH	
		CASE	2500+ 5000+
04060800C	6 x 8	100	\$1.24 \$0.93



Vellum Enveloped Cleaning Cloths



## Customizable Jewelry Care Cloths

Estimated lead time: 4 - 6 weeks for custom printed cloths.  
Minimum Order is 144 cloths.

CODE	SIZE (inches)	PRICE
04966800C	6 x 8 (envelope)	\$1.80/ea
04981000C	8 x 10 (poly bag)	\$2.15/ea
04912150C	12 x 15 (poly bag)	\$3.49/ea
04961700C	11 x 14 (boxed)	\$3.95/ea



## Light Blue Diamond & Gem Cloths

Estimated lead time: 4 - 6 weeks for custom printed cloths from approved art.  
Minimum Order is 144 cloths.

**04780800C** | 8 x 8" Blue cloth | \$2.39/ea

Microfiber Cloth removes small dust, oily film, fingerprints and other residue from fine jewelry. Chemical Free. Lint Free. AVAILABLE IN LIGHT BLUE ONLY.



All print orders subject to set-up charges. Applicable artwork, and plate charges may apply. See page 130.



# IN STOCK

## Jewelry Care

Estimated lead time: 2 - 3 weeks for printed items from approved art.

### Repair Envelopes

 **NO PLATE CHARGES!**

CODE	DESCRIPTION	SIZE (inches)	PRICE/EACH			
			1000	3000	5000	10000
A 09850000	2-Part NCR	4.25 x 9	\$0.22	\$0.21	\$0.17	\$0.14
B 09845200	Plain-no perf., text or numbers	3.5 x 6.125	\$0.07	\$0.06	\$0.05	\$0.04
C 09845300	Double Perforated	3.5 x 6.125	\$0.15	\$0.13	\$0.11	\$0.10
D 09845400	Single Perforated	3.5 x 6.125	\$0.15	\$0.13	\$0.11	\$0.10
E 0985000E	2-part NCR - NO PRINT	4.25 x 9	\$0.09	\$0.08	\$0.07	\$0.06

• Prices include one color printing. A second color is \$ 0.029/each.  
Minimum 1000 per style. Printing colors: Black, Red, Green and Blue



Please allow 2 - 3 weeks for printing.  
\$34 set-up charge applies.

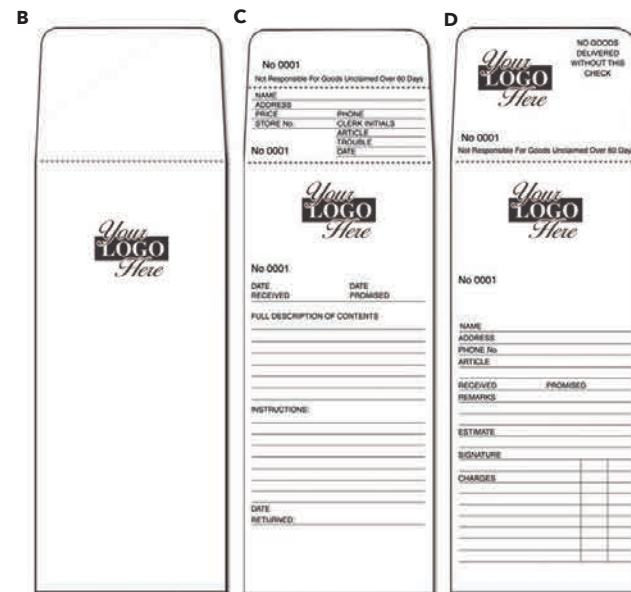

### Tags and Miscellaneous Accessories



CODE	DESCRIPTION	PACK MIN.	PRICE
E 08270207	Plastic Ring Tags - Gold	Box/1000	\$88.78/Box
F 08270208	Plastic Ring Tags - Silver	Box/1000	\$88.78/Box
G 08090707	Plastic With String Tags - Gold	Box/1000	\$88.78/Box
H 08090708	Plastic With String Tags - Silver	Box/1000	\$88.78/Box
I 08810800	Super Mylar Ring Tags - Wide	Box/1000	\$33.92/Box
J 08810700	Super Mylar Ring tags - Narrow	Box/1000	\$23.32/Box
08833000	Fine Pen Marker (not shown)	1	\$9.81/each - not shown

Available for immediate shipping for above items.

All print orders subject to set-up charges. Applicable artwork, and plate charges may apply. See page 130.

# JEWELRY DISPLAY





# CREATE YOUR OWN LOOK

**Step 1:** Choose your platforms profile. These can be made in any size.

**REVEAL**  
Shown in  
Novasuede



**WHISPER**  
Shown in  
Novasuede



**ECLIPSE**  
Shown in  
Novasuede

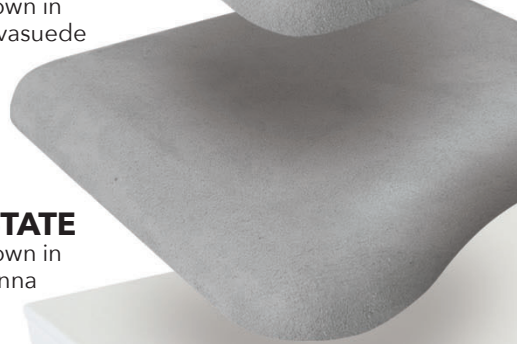

**ESTATE**  
Shown in  
Vienna



**VANTAGE**  
Shown in  
Vienna

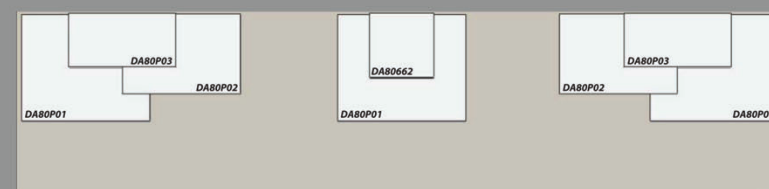
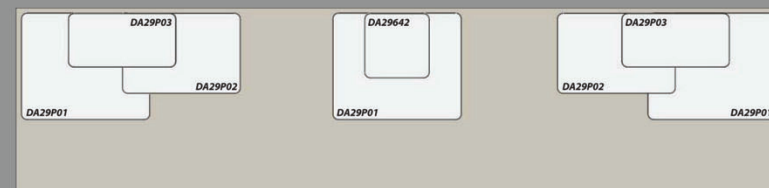
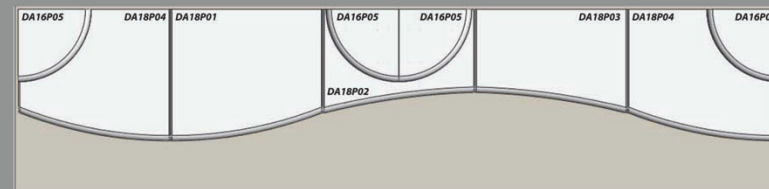
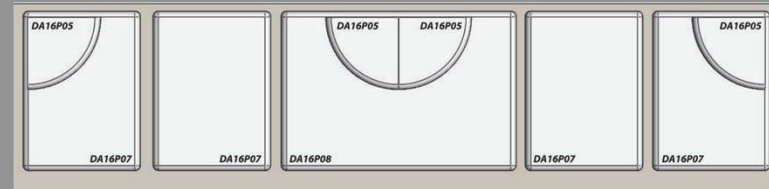

**Step 2:** Choose your elements. Options: magnetics or hide a tag.

# CREATE YOUR OWN LOOK

## ELEMENT AND SHOWCASE PLATFORM STYLES

Call our experts for assistance.

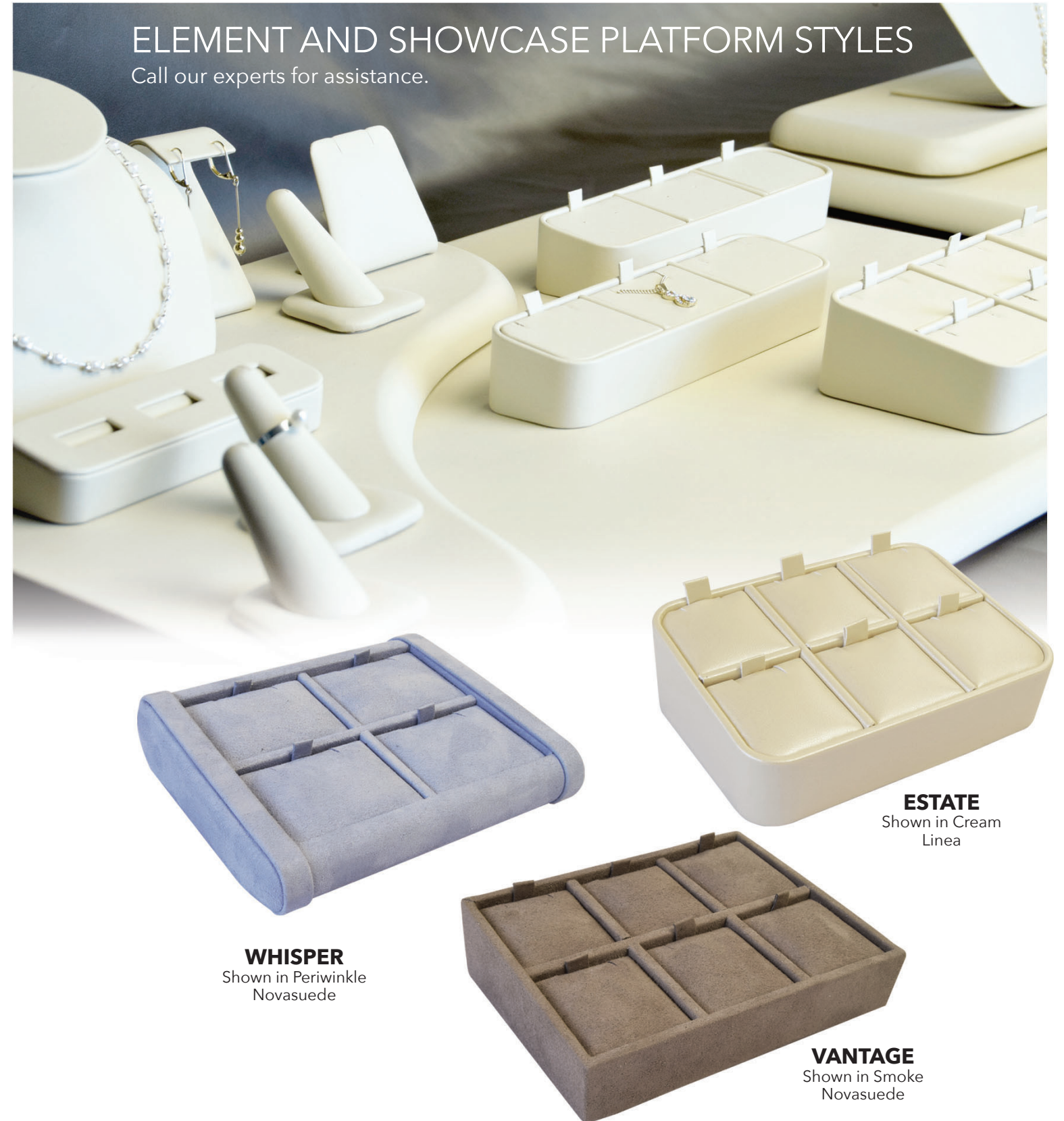

**WHISPER**  
Shown in Periwinkle  
Novasuede

**ESTATE**  
Shown in Cream  
Linea

**VANTAGE**  
Shown in Smoke  
Novasuede



# CREATE YOUR OWN LOOK

## FABRICS & COLOR CHOICES

CALL OUR EXPERTS FOR ASSISTANCE.

### Fabric for Floorboards - Minimum order of 2 yards x 54" wide Cut Yardage Pricing

54"	Vienna	FIF1007936	\$52.00/yard
54"	Linea	FIF1037700	\$61.00/yard
49"	Charisma	FIF1037722	\$69.00/yard
54"	Elite	FIF1037723	\$69.00/yard
54"	Nova	FIF1037724	\$112.00/yard

Lead times 2 - 3 weeks.

Cutting Charge:  
\$70.00 for any order  
under 10 yards.

# CREATE YOUR OWN LOOK

**Step 3:** Choose your fabric color and style. Options: metal or wood details.



Elements shown  
in Black Vienna  
Leatherette

### Vienna Leatherette - Group A



Chalk Frost Pistachio



Mocha Metallic Bronze Copper



Black Aubergine Port



Elements shown  
in Palladium  
Inspiration Linea

### Inspirations Linea - Group B



Moon Glow Paradiso Pecan Shell



Classic Bronze Caponata Sepia



Phantom Palladium Carbon



Elements shown  
in Silver  
Charisma Suede

### Charisma Suede - Group B



Jade Blue Topaz Mink



Taupe Silver Butternut



Palomino Fawn Buff



Elements shown  
in Gainsborough  
Novasuede

### Novasuede - Group C



Smoke Stone Grey Powder Grey



Taupe Beige Buttercup



Periwinkle Sky Blue Blue Max

JEWELRY DISPLAY

JEWELRY DISPLAY



# IN STOCK

## Ring Showcase Displays

Available for immediate shipment.

Save 25% when you buy \$500 or more!

# IN STOCK

Available for immediate shipment.

## Pendant/Earring and Mix Showcase Displays

Save 25% when you buy \$500 or more!

JEWELRY DISPLAY

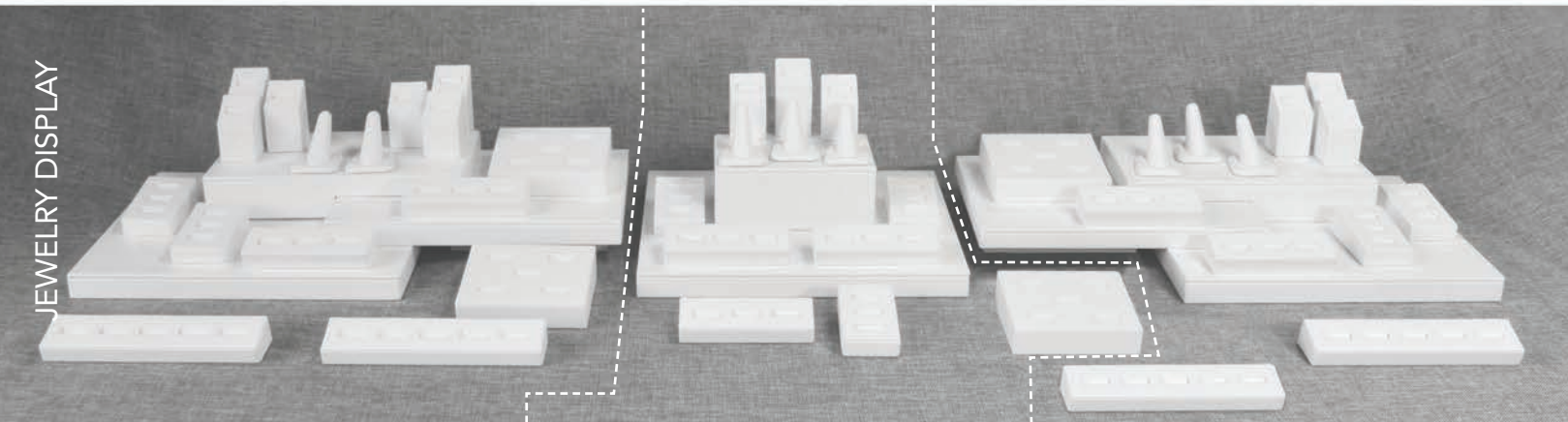

### Section 1

16 sku capacity - 40 Rings

**\$174.12\***

\*Platforms not included

### Section 2

12 sku capacity - 29 Rings

**\$150.76\***

\*Platforms not included

### Section 3

14 sku capacity - 33 Rings

**\$137.15\***

\*Platforms not included

Complete 6 foot - 102 ring element display - \$462.03

Buy \$500+ **\$346.52**

Add all platforms as shown - \$278.22

Buy \$500+ **\$208.66**

JEWELRY DISPLAY

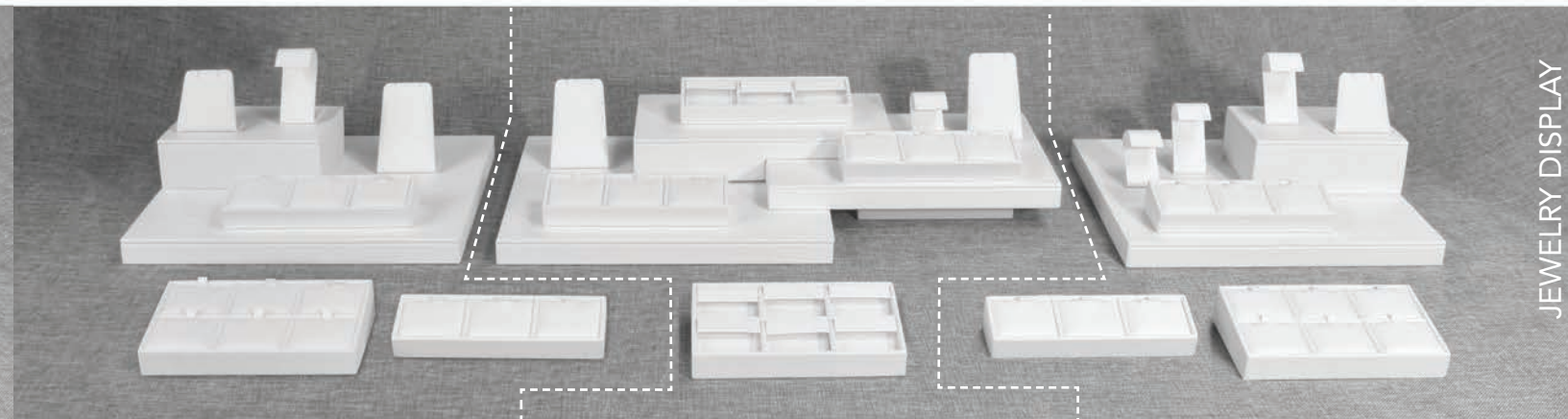

### Section 1

15 sku capacity - 5 Pendants, 10 Earrings

**\$86.00\***

\*Platforms not included

### Section 2

18 sku capacity - 5 Pendants, 13 Earrings

**\$107.21\***

\*Platforms not included

### Section 3

16 sku capacity - 13 Pendants, 3 Earrings

**\$76.63\***

\*Platforms not included

Complete 5 foot - 50 pendant/earring element display - \$269.84

Buy \$500+ **\$202.38**

Add all platforms as shown - \$218.41

Buy \$500+ **\$163.81**

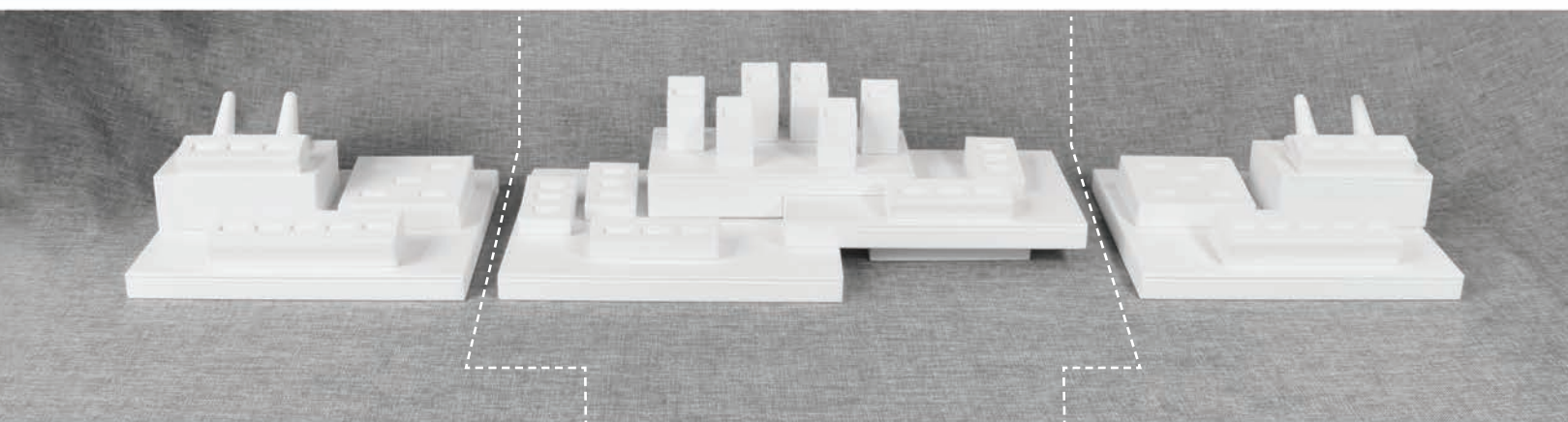

### Section 1

5 sku capacity - 15 Rings

**\$58.09\***

\*Platforms not included

### Section 2

11 sku capacity - 21 Rings

**\$105.65\***

\*Platforms not included

### Section 3

5 sku capacity - 15 Rings

**\$58.09\***

\*Platforms not included

Complete 5 foot - 51 ring element display - \$221.83

Buy \$500+ **\$166.37**

Add all platforms as shown - \$287.96

Buy \$500+ **\$215.97**

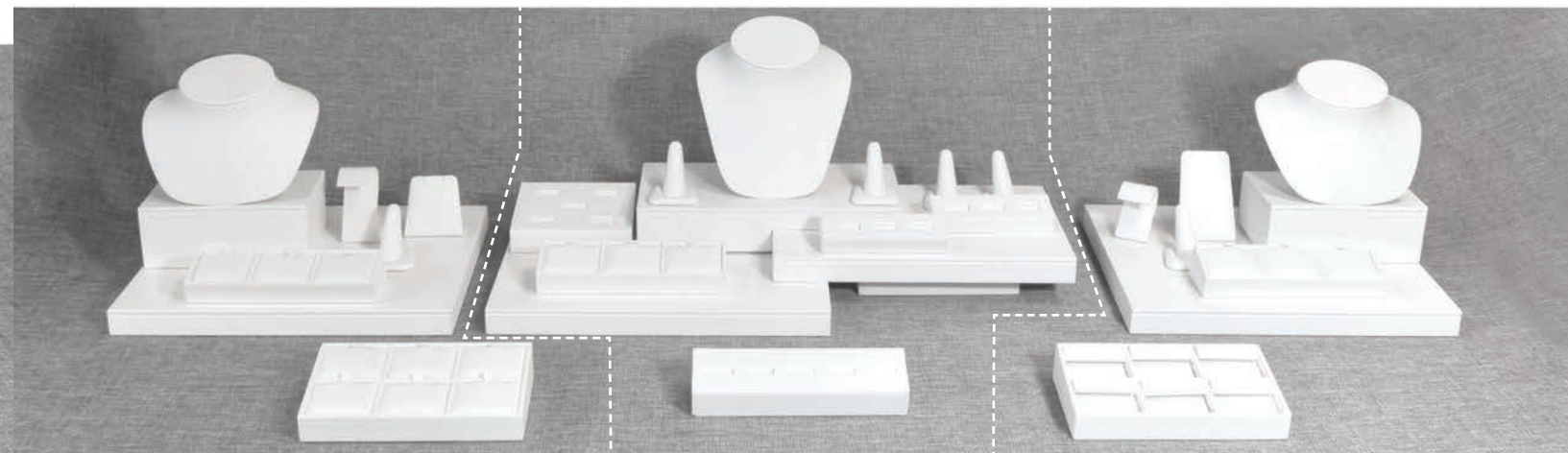

### Section 1

13 sku capacity - 1 Ring, 8 Pendants, 4 Earrings

**\$87.06\***

\*Platforms not included

### Section 2

24 sku capacity - 20 Rings, 4 Pendants

**\$136.79\***

\*Platforms not included

### Section 3

13 sku capacity - 1 Ring, 2 Pendants, 10 Earrings

**\$90.21\***

\*Platforms not included

Complete 5 foot - 50 mix element display - \$314.06

Buy \$500+ **\$235.54**

Add all platforms as shown - \$246.48

Buy \$500+ **\$184.86**







# IN STOCK

## Platforms and Risers

Available for immediate shipment.

Save 25% when you buy \$500 or more!

Item	Part No. / Description	Price/ea.	Item	Part No. / Description	Price/ea.
	<b>DA80P01-SC</b> Platform 12 x 10 x .875"	\$34.61		<b>DA80P03-SC</b> Platform 10 x 5 x 1.75"	\$33.06
	<b>BUY \$500+</b>	<b>\$25.96</b>		<b>BUY \$500+</b>	<b>\$24.80</b>
	<b>DA80P02-SC</b> Platform 11 x 7.5 x 1.875"	\$35.65		<b>DA80332-SC</b> Riser 3 x 3 x 2"	\$9.60
	<b>BUY \$500+</b>	<b>\$26.74</b>		<b>BUY \$500+</b>	<b>\$7.20</b>
	<b>DA80662-SC</b> Riser 6 x 6 x 2"	\$22.92			
	<b>BUY \$500+</b>	<b>\$17.19</b>			

\* Display case floorboards are not included in the price. Material for covering your own floorboards is available and is priced by the yard. See page 65.

### Platform layout suggestions



4 foot case - 26" wide, 10" deep



5 foot case - 44" wide, 10" deep



6 foot case - 52" wide, 10" deep • 19" left, 12" center and 19" right









Total price does not include applicable taxes. In stock displays and platforms are only available in VANTAGE style in Vienna fabric option.

# IN STOCK

## Neck Forms



Save 25% when you buy \$500 or more!

Item	Part No. / Description	Price/ea.	Item	Part No. / Description	Price/ea.
	<b>DANF1021-SC</b> Neck form 7.125 x 2.25 x 8.625"	\$36.50		<b>DANF1010-SC</b> Neck form 7.75 x 8.5 x 11"	\$55.60
	<b>BUY \$500+</b>	<b>\$27.38</b>		<b>BUY \$500+</b>	<b>\$41.70</b>
	<b>DANF1026-SC</b> Neck form 6 1/2 x 4 1/2 x 4"	\$22.00		<b>DANF1029-SC</b> Neck form 7 x 6 1/2 x 7 1/4"	\$37.42
	<b>BUY \$500+</b>	<b>\$16.50</b>		<b>BUY \$500+</b>	<b>\$28.07</b>
	<b>DANF1028-SC</b> Neck form 6 1/2 x 4 1/2 x 6"	\$35.00		<b>DANF2003-SC</b> Neck form 3 x 2 1/2 x 3 1/2"	\$14.39
	<b>BUY \$500+</b>	<b>\$26.25</b>		<b>BUY \$500+</b>	<b>\$10.79</b>
	<b>DANF1027-SC</b> Neck form 7 x 6 1/2 x 4 3/4"	\$49.00		<b>DANF1034-SC</b> Neck form 6 3/4 x 6 x 7 5/8"	\$39.80
	<b>BUY \$500+</b>	<b>\$36.75</b>		<b>BUY \$500+</b>	<b>\$29.85</b>



# IN STOCK

## Ring Stands and Trays Available for immediate shipment.

Save 25% when you buy \$500 or more!

Item	Part No. / Description	Price/ea.	Item	Part No. / Description	Price/ea.
	<b>DA80058UR-SC</b> Ring stand 1 5/8 x 1 1/2 x 2 1/8"	\$7.93 <b>BUY \$500+ \$5.94</b>		<b>DA80070S-SC</b> Ring stand set	\$39.00 <b>BUY \$500+ \$29.25</b>
	<b>DA80059UR-SC</b> Ring stand 1 5/8 x 1 1/2 x 2 1/2"	\$8.00 <b>BUY \$500+ \$6.00</b>			
	<b>DA80060UR-SC</b> Ring stand 1 5/8 x 1 1/2 x 2 3/4"	\$8.10 <b>BUY \$500+ \$6.08</b>		<b>DA8004RV-SC</b> 4 ring vertical bar 1 3/4 x 4 x 1"	\$13.43 <b>BUY \$500+ \$10.08</b>
	<b>DA28A01UR-SC</b> Universal ring tray 2 3/8 x 2 1/4 x 1 1/2"	\$7.29 <b>BUY \$500+ \$5.46</b>		<b>DA8005RH-SC</b> 5 ring horizontal bar 7 1/4 x 1 5/8 x 1"	\$16.31 <b>BUY \$500+ \$12.23</b>
	<b>DA8002RV-SC</b> 2 ring vertical bar 1 3/4 x 2 1/8 x 1"	\$9.60 <b>BUY \$500+ \$7.20</b>		<b>DA28C05UR-SC</b> 5 universal ring tray 6 3/4 x 2 1/4 x 1 1/2"	\$14.39 <b>BUY \$500+ \$10.79</b>
	<b>DA8002RH-SC</b> 2 ring horizontal bar 3 1/4 x 1 5/8 x 1"	\$9.60 <b>BUY \$500+ \$7.20</b>		<b>DA28D05UR-SC</b> 5 universal ring tray 4 5/8 x 4 x 1 1/2"	\$19.19 <b>BUY \$500+ \$14.39</b>
	<b>DA8003RV-SC</b> 3 ring vertical bar 1 3/4 x 3 x 1"	\$11.19 <b>BUY \$500+ \$8.40</b>		<b>DA28E05RD-SC</b> 5 ring duo tray 6 3/4 x 4 x 1 1/2"	\$22.71 <b>BUY \$500+ \$17.03</b>
	<b>DA8003RH-SC</b> 3 ring horizontal bar 4 1/2 x 1 5/8 x 1"	\$12.01 <b>BUY \$500+ \$9.01</b>		<b>DA28E07UR-SC</b> 7 ring tray 6 3/4 x 4 x 1 1/2"	\$22.39 <b>BUY \$500+ \$16.79</b>

# IN STOCK

## Ring Stands, Pendant Stands and Trays Available for immediate shipment.

Save 25% when you buy \$500 or more!

Item	Part No. / Description	Price/ea.	Item	Part No. / Description	Price/ea.
	<b>DA28D07UR-SC</b> 7 universal ring tray 4 5/8 x 4 x 1 1/2"	\$22.47 <b>BUY \$500+ \$16.85</b>		<b>DAF400T-SC</b> Ring feature stand 2 5/8 x 2 1/4 x 2.625"	\$15.99 <b>BUY \$500+ \$11.99</b>
	<b>DA28E08UR-SC</b> 8 ring tray 6 3/4 x 4 x 1 1/2"	\$21.75 <b>BUY \$500+ \$16.31</b>		<b>DAF400S-SC</b> Ring feature stand 2 5/8 x 2 1/4 x 2.25"	\$16.67 <b>BUY \$500+ \$12.50</b>
	<b>DA28D08UR-SC</b> 8 universal ring tray 4 5/8 x 4 x 1 1/2"	\$20.29 <b>BUY \$500+ \$15.22</b>		<b>DARF110-SC</b> Ring finger 2 7/8 x 2 5/8 x 1 7/8"	\$6.25 <b>BUY \$500+ \$4.69</b>
	<b>DA28E11UR-SC</b> 11 ring tray 6 3/4 x 4 x 1 1/2"	\$21.75 <b>BUY \$500+ \$16.31</b>		<b>DARD130-SC</b> Ring disc min. order qty. of 12 1 1/4" Diameter	\$0.54 <b>BUY \$500+ \$0.40</b>
Item	Part No. / Description	Price/ea.	Item	Part No. / Description	Price/ea.
	<b>DA350P-SC</b> Pendant stand 2 3/8 x 1 1/2 x 3 1/2"	\$8.00 <b>BUY \$500+ \$6.00</b>		<b>DA225P-SC</b> Pendant stand 2 3/8 x 2 1/4 x 2"	\$6.40 <b>BUY \$500+ \$4.80</b>
	<b>DA345P-SC</b> Pendant stand 3 x 2 x 4"	\$14.93 <b>BUY \$500+ \$11.19</b>		<b>DA234P-SC</b> Pendant stand 2 1/2 x 2 x 3"	\$9.60 <b>BUY \$500+ \$7.20</b>
	<b>DA28A01PD-SC</b> Pendant tray 2 3/8 x 2 1/4 x 1 1/2"	\$8.32 <b>BUY \$500+ \$6.24</b>		<b>DA28C03PD-SC</b> 3 pendant tray 6 3/4 x 2 1/4 x 1 1/2"	\$19.19 <b>BUY \$500+ \$14.39</b>
	<b>DA28D04PD-SC</b> 4 pendant tray 4 5/8 x 4 x 1 1/2"	\$25.27 <b>BUY \$500+ \$18.95</b>		<b>DA28D06PD-SC</b> 6 pendant tray 4 5/8 x 4 x 1 1/2"	\$27.19 <b>BUY \$500+ \$20.39</b>
	<b>DA28E06PD-SC</b> 6 pendant tray 6 3/4 x 4 x 1 1/2"	\$27.19 <b>BUY \$500+ \$20.39</b>		<b>DA28E08PD-SC</b> 8 pendant tray 6 3/4 x 4 x 1 1/2"	\$30.39 <b>BUY \$500+ \$22.79</b>



# IN STOCK

## Earring Stands and Trays

Save 25% when you buy \$500 or more!

Available for immediate shipment.











Item	Part No. / Description	Price/ea.	Item	Part No. / Description	Price/ea.
	<b>DACES14-SC</b> Earring tree stand 2 x 2 x 3"	\$9.00 <b>BUY \$500+ \$6.75</b>		<b>DACES13-SC</b> Earring stand 1 1/4 x 1 7/8 x 2 3/4"	\$7.95 <b>BUY \$500+ \$5.96</b>
	<b>DACES36-SC</b> Earring stand 2 3/4 x 1 3/4 x 3 1/2"	\$9.00 <b>BUY \$500+ \$6.75</b>		<b>DASLD6-SC</b> Earring sled 2 x 8 1/4 x 2"	\$9.60 <b>BUY \$500+ \$7.20</b>
	<b>DA28A01FE-SC</b> Flap earring tray 2 3/8 x 2 1/4 x 1 1/2"	\$9.60 <b>BUY \$500+ \$7.20</b>		<b>DA28A01PE-SC</b> Pierced earring tray 2 3/8 x 2 1/4 x 1 1/2"	\$8.24 <b>BUY \$500+ \$6.18</b>
	<b>DA28C03FE-SC</b> 3 flap earring tray 6 3/4 x 2 1/4 x 1 1/2"	\$15.99 <b>BUY \$500+ \$11.99</b>		<b>DA28C03PE-SC</b> 3 pierced tray 6 3/4 x 2 1/4 x 1 1/2"	\$17.27 <b>BUY \$500+ \$12.95</b>
	<b>DA28D04FE-SC</b> 4 flap earring tray 4 5/8 x 4 x 1 1/2"	\$25.27 <b>BUY \$500+ \$18.95</b>		<b>DA28D04PE-SC</b> 4 pierced earring tray 4 5/8 x 4 x 1 1/2"	\$22.21 <b>BUY \$500+ \$16.66</b>
	<b>DA28D06FE-SC</b> 6 flap earring tray 4 5/8 x 4 x 1 1/2"	\$28.79 <b>BUY \$500+ \$21.59</b>		<b>DA28D06PE-SC</b> 6 pierced earring tray 4 5/8 x 4 x 1 1/2"	\$31.18 <b>BUY \$500+ \$23.39</b>
	<b>DA28E06FE-SC</b> 6 flap earring tray 6 3/4 x 4 x 1 1/2"	\$28.79 <b>BUY \$500+ \$21.59</b>		<b>DA28E06PE-SC</b> 6 pierced earring tray 6 3/4 x 4 x 1 1/2"	\$27.19 <b>BUY \$500+ \$20.39</b>
	<b>DA28E08FE-SC</b> 8 flap earring tray 6 3/4 x 4 x 1 1/2"	\$34.69 <b>BUY \$500+ \$26.01</b>		<b>DA28E08PE-SC</b> 8 pierced earring tray 6 3/4 x 4 x 1 1/2"	\$27.19 <b>BUY \$500+ \$20.39</b>

# IN STOCK

## Earring, Bangle and Bracelet Stands, Chain Ramps, Counter Pads and Signage

Available for immediate shipment.

Save 25% when you buy \$500 or more!

Item	Part No. / Description	Price/ea.	Item	Part No. / Description	Price/ea.
	<b>05000755</b> Earring stand 7 x 4 1/2 x 1 3/4" <b>New</b>	\$25.45 <b>BUY \$500+ \$19.09</b>		<b>DABS185-SC</b> Bracelet sled 1 1/4 x 9 1/4 x 1 3/4"	\$7.90 <b>BUY \$500+ \$5.93</b>
	<b>DASBS12-SC</b> Bangle "T" bar 7 1/8 x 2 3/4 x 5 1/4" (dia. 1.625")	\$25.50 <b>BUY \$500+ \$19.13</b>		<b>DABS485-SC</b> Bracelet sled 4 x 9 5/8 x 1 7/8"	\$13.65 <b>BUY \$500+ \$10.24</b>
	<b>DAJP350V-SC</b> Bracelet pillow w/stand 3 1/4 x 3 1/4 x 3 1/4"	\$8.90 <b>BUY \$500+ \$6.68</b>		<b>DADB425-SC</b> Bracelet dome 4 1/8 x 5 1/8 x 2 1/2"	\$26.90 <b>BUY \$500+ \$20.18</b>
	<b>DACHR16-SC</b> Chain ramp / Rem. pad 10 1/4 x 16" chain pad 10 3/4 x 16 1/2 x 3 1/2"	\$96.00 <b>BUY \$500+ \$72.00</b>		<b>DA1081R-SC</b> Pres. tray w/ring 10 1/2 x 8 5/8 x 1"	\$40.87 <b>BUY \$500+ \$30.65</b>
	<b>DACW884-SC</b> Chain display wedge 8 x 8 x 3.75"	\$41.26 <b>BUY \$500+ \$30.95</b>		<b>DAPCF5510-SC</b> Counter pad plain 10 1/4 x 5 3/8 x 3/4" closed 10 1/4 x 11 x 3/8" open	\$29.02 <b>BUY \$500+ \$21.77</b>
	<b>DASB211</b> Sign stand 2 3/4 x 2 3/16 x 1 1/4"	\$8.53 <b>BUY \$500+ \$6.40</b>			





# IN STOCK

Specialty Items Available for immediate shipment.

Save 25% when you buy \$500 or more!

Item	Part No. / Description	Price/ea.	Item	Part No. / Description	Price/ea.
	<b>05000300-SC</b> Loose Diamond Arch 11.5" x 4" x 1.5"	\$59.60 <b>BUY \$500+ \$44.70</b>		<b>05000301</b> Diamond Cup 1.125" diameter x .75"	\$9.60 <b>BUY \$500+ \$7.20</b>
	<b>05000299-SC</b> Pearl Half Moon 8" x 8" x 3.25"	\$76.60 <b>BUY \$500+ \$57.45</b>		<b>05000298-SC</b> Wave Chain Ramp 10.125" x 9" x 2.625"	\$71.08 <b>BUY \$500+ \$53.31</b>
	Sign size: 3.9375" x 2.375" <b>05000300</b> Acrylic Sign 1.1875" x 4" x 2.75"	\$12.90 <b>BUY \$500+ \$9.68</b>		<b>05000302</b> Bevelled Edge Mirror 8.5" x 8.25" x 5.5"	\$44.00 <b>BUY \$500+ \$33.00</b>
	<b>05000581-SC</b> Pendant/earring tray with PVC signage 4.75" x 9.5" x 2"	\$43.00 <b>BUY \$500+ \$32.25</b>		<b>36301103</b> Small Vision Box 2.68 x 2.68 x .75"	\$1.00
				<b>36302103</b> Medium Vision Box 3.5 x 3.5 x .75"	\$1.33
				<b>36303103</b> Large Vision Box 4.25 x 4.25 x .75"	\$1.66
				<b>69300103</b> Base for Vision Box 2.24 x 2.24 x .62" Bag of 12	\$0.83

# WATCH WINDERS AND STORAGE





# IN STOCK

## Watch Winders

Prices displayed are wholesale.  
Ask your sales representative for retail pricing.



### Langdon

83012015

- Up to four of your automatic timepieces
- High gloss black exterior is paired with a supple black leatherette interior lining
- Dual Japanese motors
- Chromed compass style hinges and working lock and key

Size: 43.5 x 18.5 x 21 cm • **\$285.00** each



### Gustovo

83821011

- Watch winder and storage box can accommodate up to five watches
- High gloss black carbon fibre exterior finish with carbon fibre leatherette interior lining and silver tone hardware
- Can be powered with the included 110V AC adapter or battery back-up
- Lock and key

Size: 19 x 26.3 x 21.5 cm • **\$192.50** each

# IN STOCK

## Watch Winders

Prices displayed are wholesale.  
Ask your sales representative for retail pricing.



### Trevor

83093015

- Sleek, automatic watch winder
- Black piano finish with a supple black interior accented by bright nickel hardware and knobs
- Can be powered with the included 110V AC adapter or battery back-up

Size: 24 x 16 x 18 cm • **\$187.50** each



### Raymond

83544015

- Single automatic watch winder
- Black leather exterior with contrast red stitching, your watch will be encased by a soft grey interior
- Can be powered with the included 110V AC adapter or battery back-up

Size: 14.6 x 15 x 16 cm • **\$110.00** each



### Reed

83104089

- Single automatic watch winder will store and display your watch
- High gloss, dark grey finish with black leatherette lining, accented by silver tone hardware
- Can be powered with the included 110V AC adapter or battery back-up

Size: 14.5 x 15.5 x 18 cm x 7" • **\$147.50** each

JEWELRY STORAGE

JEWELRY STORAGE



# IN STOCK

## Fashion and Travel Storage

Prices displayed are wholesale.  
Ask your sales representative for retail pricing.



**Aspen**  
61876015

- Black leatherette exterior with a soft grey suedine interior watch case holds 3-5 watches
- Cushioned inner roll and snap closure

Size: 21.5 x 8.8 x 8.8 cm • **\$25.00** each



**Austin**  
61876012

- Brown leatherette exterior with soft grey interior watch case holds 3-5 watches
- Cushioned inner roll and snap closure

Size: 21 x 8.5 x 8.5 cm • **\$25.00** each



**Sara/Laura/Margo**  
61512000    61512015    61512090

- Lizard style exterior accented by a velvet cloth interior.
- Ring pad and individual compartments
- Velvet cloth pouch behind mirror

Size: 12.5 x 12.5 x 5.5 cm • **\$17.00** each



**Ainsley**  
61532015

- Black leather exterior with a soft black velvet interior
- Three different sectioned lift out trays

Size: 26 x 10 x 6 cm • **\$34.00** each



**Iris**  
61863015

- Crocodile textured leatherette with cream velvet lining.
- Ring rolls, earring holders, and necklace hooks
- Velcro closures

Size: 57 x 26.5 cm (open) • **\$23.00** each

# BAGS

## EUROTOTES, PAPER, POLY & REUSABLE





# IN STOCK

## Rope Handle Eurototes



08V - Silver

Available Colours



08V - Silver  
Matches Vantage Silver  
Hinged Packaging  
See page 31.

07V - Gold  
Matches Vantage Gold  
Hinged Packaging  
See page 31.

Estimated lead time: 2 - 3 weeks for printed items from approved art.



**FOIL PRINT**  
100+ 29¢ each  
1000+ 26¢ each  
2500+ 22¢ each



56G - Purple  
Matches Geo Purple  
Hinged Packaging  
See page 27.

27G - Bronze  
Matches Geo Bronze  
Hinged Packaging  
See page 27.



66E - Aubergine  
Matches Eclipse Aubergine  
Hinged Packaging  
See page 21.

81E - Blue  
Matches Eclipse Blue  
Hinged Packaging  
See page 21.

### Vantage II Eurototes

- 150 gsm uncoated art paper with 5 mm pp cord knotted handles
- Available in Silver or Gold

CODE	SIZE (inches)	PRICE/EACH		
		100+	500+	1000+
A 230606 ___	6 x 3.5 x 6 x 3.5	\$0.83	\$0.76	\$0.65
B 231008 ___	10.5 x 5 x 8.5 x 5	\$1.05	\$0.95	\$0.81



27G - Bronze

Shimmer  
Paper Detail

### Eclipse and Geo Eurototes

- 150 gsm uncoated art paper with 5 mm pp cord knotted handles
- Available in Bronze, Purple, Aubergine and Blue

# IN STOCK

## Luxury Grosgrain Handle Eurototes



### Luxury Grosgrain Handle Eurototes

- Gloss and matte lamination
- 158 gsm art paper
- 7/8" matching grosgrain, knotted handles
- Fold over top turn and cardboard reinforced bottom

CODE	SIZE (inches)	CASE	PRICE/EACH		
			100+	500+	1000+
A 230606 ___	6 x 3 x 6 x 3	100	\$0.94	\$0.84	\$0.73
B 230810 ___	8 x 4 x 10 x 4	100	\$0.99	\$0.89	\$0.76
C 231209 ___	12.5 x 4.5 x 9 x 4.5	100	\$1.19	\$1.07	\$0.92
231612 ___	16 x 6 x 12 x 6	100	\$1.61	\$1.45	\$1.25
D 232014 ___*	20 x 6 x 14 x 6	100	\$1.81	\$1.63	\$1.40

\* champagne and pewter not available in this size.

Estimated lead time: 2 - 3 weeks for printed items from approved art.

Available Colors



**DIGITAL PRINT**  
100+ \$1.25 each  
1000+ 99¢ each  
300 bags minimum



**FOIL PRINT**  
100+ 29¢ each  
1000+ 26¢ each  
2500+ 22¢ each



15BM  
Black Matte

15BG  
Black Gloss

02C  
Champagne

08P  
Pewter

00W  
White

All print orders subject to set-up charges. Applicable artwork, and plate charges may apply. See page 130.



# IN STOCK

## Rope Handle Eurototes

BAGS



### Paper Eurotote with Polypropelene Rope Handle

- Matte lamination
- 157 gsm art paper
- 5 mm pp cord knotted handle
- Minimum order is 100 in any size
- Folded top turn and cardboard reinforced bottom

CODE	TYPE	SIZE (inches)	PRICE/EACH		
			100+	500+	1000+
A 239606 __	Novelty	6 x 3.5 x 6 x 3.5	\$0.72	\$0.64	\$0.61
B 239709 __	Small gift	9 x 3.5 x 7 x 3.5	\$0.85	\$0.75	\$0.70
C 239810 __	Gift	8 x 4 x 10 x 4	\$0.91	\$0.83	\$0.76
D 230908 __ T	Trapezoid	9/7 x 4 x 8.5 x 4	\$1.02	\$0.89	\$0.86
E 238116 __	Fashion	16 x 6 x 12 x 6	\$1.61	\$1.41	\$1.35
F 231011 __	Watch	10 x 5 x 11 x 5	\$1.03	\$0.87	\$0.83



	15-Black	00-White	07-Gold	08-Silver	42-Brown	11-Blue	10-Green
Novelty	✓	✓	✓	✓	✓	✓	✓
Small Gift	✓	✓	✓	✓	✓	✓	✓
Gift	✓	✓	✓	✓	✓	✓	✓
Trapezoid	✓	✓	✓	—	✓	—	—
Fashion	✓	✓	✓	✓	✓	—	—
Watch	✓	✓	✓	—	—	—	—

Estimated lead time: 2 - 3 weeks for printed items from approved art.

**DIGITAL PRINT**  
100+ \$1.25 each  
1000+ 99¢ each  
300 bags minimum

**FOIL PRINT**  
100+ 29¢ each  
1000+ 26¢ each  
2500+ 22¢ each

# IN STOCK

## All Paper Eurototes

BAGS



### Paper Eurotote with Paper Rope Handle

- 100% recyclable
- 40% post-consumer waste
- 190 gsm uncoated paper
- 8 mm paper cord knotted handles
- Folded top turn and cardboard reinforced bottom

CODE	SIZE (inches)	CASE	PRICE/EACH		
			100+	500+	1000+
A 230606 _____	6 x 3.5 x 6 x 3.5	100	\$0.65	\$0.59	\$0.50
B 230810 _____	8 x 4 x 10 x 4	100	\$0.71	\$0.66	\$0.56
C 231013 _____	10 x 5 x 13 x 5	100	\$0.81	\$0.73	\$0.62
D 231612 _____	16 x 6 x 12 x 6	100	\$1.22	\$1.11	\$0.94



100% Recyclable

Available Colors

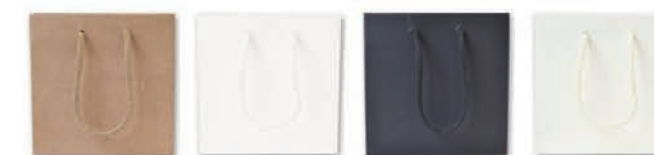

75AK Kraft    00AW White    15AB Black    28AC Cream

Estimated lead time: 2 - 3 weeks for printed items from approved art.

**FOIL PRINT**  
100+ 29¢ each  
1000+ 26¢ each  
2500+ 22¢ each

All print orders subject to set-up charges. Applicable artwork, and plate charges may apply. See page 130.



# CREATE YOUR OWN LOOK

## Full Color Paper Eurototes

Make a creative impression...  
the combinations are endless!



# SPECIAL ORDER

## 5th Avenue Eurototes



Thick Woven  
Handle Detail



08 - Silver

### Prices include up to 2 ink print colors:

SIZE (inches)	TYPE	PRICE/EACH		
		3,000	5,000	10,000
6 x 3.5 x 6 x 3.5	Novelty	\$0.540	\$0.458	\$0.413
9 x 3.5 x 7 x 3.5	Small Gift	\$0.680	\$0.579	\$0.521
8 x 4 x 10 x 4	Petite	\$0.732	\$0.623	\$0.560
9/7 x 4 x 8.5 x 4	Trapezoid	\$0.899	\$0.764	\$0.688
3.375 x 3.5 x 13 x 3.5	Wine	\$0.680	\$0.583	\$0.525
16 x 6 x 12 x 6	Fashion	\$1.414	\$1.204	\$1.085
16 x 6 x 19 x 6	Saville	\$1.709	\$1.538	\$1.477

### Prices include 4 color process print:

SIZE (inches)	TYPE	PRICE/EACH		
		3,000	5,000	10,000
6 x 3.5 x 6 x 3.5	Novelty	\$0.590	\$0.450	\$0.434
9 x 3.5 x 7 x 3.5	Small Gift	\$0.745	\$0.608	\$0.547
8 x 4 x 10 x 4	Petite	\$0.760	\$0.654	\$0.588
9/7 x 4 x 8.5 x 4	Trapezoid	\$0.944	\$0.803	\$0.722
3.375 x 3.5 x 13 x 3.5	Wine	\$0.714	\$0.612	\$0.551
16 x 6 x 12 x 6	Fashion	\$1.484	\$1.264	\$1.139
16 x 6 x 19 x 6	Saville	\$1.794	\$1.615	\$1.551

• Combination foil print and ink printing available.

• No charge for printing plates  
(\$275 proof charge applies)

• Substitute a satin ribbon handle for the  
standard rope - add \$0.10/ea.

• Add metal grommets to your bag  
for only \$0.06/ea.



Unique printing  
options available.  
Double Stamping  
shown here.

Estimated lead time: 14 - 16  
weeks for delivery from  
approved art.



**FOIL PRINT**  
Add \$0.06/ea. per side  
< 25% coverage



**Create Your Own Look:**  
Choose your bag style.  
Send us your artwork.  
For 100% full color  
design, speak to your  
sales representative.

## Embossed Laminated Eurotote

- Embossed laminated finish with printed gloss coordinating color interior\*
- 210 gsm
- Thick woven handles, top slit style
- W fold & removable bottom board
- Kraft - 100% recyclable including handles made from woven paper\*\*

CODE	SIZE (inches)	CASE	PRICE/EACH	
			100+	1000+
A 245820 __	8 x 3.5 x 6 x 3.5	100	\$1.50	\$1.35
B 245821 __	12.5 x 4.5 x 9 x 4.5	100	\$2.25	\$2.00
C 245822 ___	17 x 6 x 12.75 x 6	100	\$3.15	\$2.85

Estimated lead time: 3 - 5 weeks for  
printed items from approved art.

**DIGITAL PRINT**  
100+ \$1.25 each  
1000+ 99¢ each  
300 bags minimum

**FOIL PRINT**  
100+ 29¢ each  
1000+ 26¢ each  
2500+ 22¢ each

Available Colors



15 Black/Gloss Black\*    08 Silver/Gloss Silver\*    00 White/Gloss Silver\*    75 Kraft\*\*



Kraft Paper  
Handle Detail\*\*

All print orders subject to set-up charges. Applicable artwork, and plate charges may apply. See page 130.



# SPECIAL ORDER

## Manhattan Eurototes

BAGS



### Stripe Gusset Eurotote

- Uncoated paper with varnish finish
- 180 gsm wood-free paper, varnish finish
- 5/8" poly/cotton twill knotted handle
- Folded top turn and cardboard reinforced bottom

CODE	TYPE	SIZE (inches)	CASE	PRICE /EACH		
				100+	500+	1000+
A 245845 __	Mini	5 x 4 x 6 x 4	100	\$0.79	\$0.75	\$0.72
B 245841 __	Petite	8 x 4 x 10 x 4	100	\$0.97	\$0.91	\$0.86
C 245843 __	Vanity	10 x 5 x 13 x 5	100	\$1.23	\$1.19	\$1.13
D 245844 __	Fashion	16 x 6 x 12 x 6	100	\$2.10	\$1.91	\$1.79

Available Colors



Estimated lead time: 3 - 5 weeks for printed items from approved art.

**DIGITAL PRINT**  
100+ \$1.25 each  
1000+ 99¢ each  
300 bags minimum

**FOIL PRINT**  
100+ 29¢ each  
1000+ 26¢ each  
2500+ 22¢ each

# SPECIAL ORDER

## Manhattan Eurototes

BAGS



### Twill Handle Eurotote

- Uncoated paper with varnish finish\*
- 180 gsm wood-free paper
- 5/8" poly/cotton twill knotted handle
- Folded top turn and cardboard reinforced bottom
- 200 gsm kraft paper 75% recycled\*\*

CODE	TYPE	SIZE (inches)	CASE	PRICE /EACH		
				100+	500+	1000+
A 245845 __	Mini	5 x 4 x 6 x 4	100	\$0.75	\$0.72	\$0.67
B 245841 __	Petite	8 x 4 x 10 x 4	100	\$0.92	\$0.87	\$0.81
C 245843 __	Vanity	10 x 5 x 13 x 5	100	\$1.26	\$1.17	\$1.11
D 245844 __	Fashion	16 x 6 x 12 x 6	100	\$2.00	\$1.81	\$1.69
E 245860 __	X-Large	20 x 6 x 14 x 6	50	\$2.43	\$2.16	\$1.93
F 245898 __	Bottle Bag	4.5 x 4.5 x 15 x 4.5	100	\$1.00	\$0.93	\$0.80
G 245856 __	Wide Gusset - Medium	12.5 x 12 x 12 x 12	100	\$3.36	\$3.08	\$2.84
H 245857 __	Wide Gusset - Large	16 x 12 x 11 x 12	100	\$3.39	\$3.12	\$2.90

Estimated lead time: 3 - 5 weeks for printed items from approved art.

Available Colors



**DIGITAL PRINT**  
100+ \$1.25 each  
1000+ 99¢ each  
300 bags minimum

**FOIL PRINT**  
100+ 29¢ each  
1000+ 26¢ each  
2500+ 22¢ each

	15* Black	00* White	75** Kraft	08* Grey	81* Ivory	12** Espresso	09* Red	41* Fuchsia	11** Navy	10* Green
Mini	✓	✓	✓	✓	DISCONTINUED	✓	✓	✓	✓	✓
Petite	✓	✓	✓	✓	✓	✓	✓	✓	✓	✓
Vanity	✓	✓	✓	✓	✓	✓	✓	✓	✓	✓
Fashion	✓	✓	✓	✓	✓	✓	✓	✓	✓	✓
X-Large	✓	✓	✓	—	—	—	—	—	—	—
Bottle	✓	✓	✓	—	—	✓	✓	—	—	—
Wide Gusset Medium	✓	✓	✓	—	—	—	—	—	—	—
Wide Gusset Large	✓	✓	✓	—	—	—	—	—	—	—

All print orders subject to set-up charges. Applicable artwork, and plate charges may apply. See page 130.

All print orders subject to set-up charges. Applicable artwork, and plate charges may apply. See page 130.



# CREATE YOUR OWN LOOK

## Gusseted Paper Merchandise Bags

Make a creative impression...  
the combinations are endless!



## Gusseted Paper Merchandise Bags

SIZE (inches)	PAPER & HANDLE	PRINT	PRICE EACH		
			5,000	10,000	30,000
10 x 3.14 x 13 x 3.14	Kraft 90 GSM - Reinforced die cut	1 Color Print	\$0.444	\$0.322	\$0.148
14 x 3.14 x 18 x 3.14	Kraft 90 GSM - Reinforced die cut	1 Color Print	\$0.585	\$0.440	\$0.156
18 x 3.14 x 22 x 3.14	Kraft 90 GSM - Reinforced die cut	1 Color Print	\$0.786	\$0.608	\$0.230
18 x 3.14 x 22 x 3.14	Kraft 90 GSM - Reinforced top turn with die cut	1 Color Print	\$0.811	\$0.628	\$0.287
10 x 3.14 x 13 x 3.14	Kraft 90 GSM - Reinforced die cut	4 Color Print	\$0.469	\$0.333	\$0.016
14 x 3.14 x 18 x 3.14	Kraft 90 GSM - Reinforced die cut	4 Color Print	\$0.610	\$0.451	\$0.205
18 x 3.14 x 22 x 3.14	Kraft 90 GSM - Reinforced die cut	4 Color Print	\$0.811	\$0.618	\$0.254
18 x 3.14 x 22 x 3.14	Kraft 90 GSM - Reinforced top turn with die cut	4 Color Print	\$0.836	\$0.637	\$0.320
10 x 3.14 x 13 x 3.14	White Kraft 125 GSM - Reinforced die cut	1 Color Print	\$0.484	\$0.351	\$0.172
14 x 3.14 x 18 x 3.14	White Kraft 125 GSM - Reinforced die cut	1 Color Print	\$0.652	\$0.492	\$0.230
18 x 3.14 x 22 x 3.14	White Kraft 125 GSM - Reinforced die cut	1 Color Print	\$0.883	\$0.686	\$0.312
18 x 3.14 x 22 x 3.14	White Kraft 125 GSM - Reinforced top turn with die cut	1 Color Print	\$0.920	\$0.715	\$0.377
10 x 3.14 x 13 x 3.14	White Kraft 125 GSM - Reinforced die cut	4 Color Print	\$0.509	\$0.362	\$0.189
14 x 3.14 x 18 x 3.14	White Kraft 125 GSM - Reinforced die cut	4 Color Print	\$0.677	\$0.502	\$0.262
18 x 3.14 x 22 x 3.14	White Kraft 125 GSM - Reinforced die cut	4 Color Print	\$0.910	\$0.695	\$0.344
18 x 3.14 x 22 x 3.14	White Kraft 125 GSM - Reinforced top turn with die cut	4 Color Print	\$0.945	\$0.723	\$0.410

### Create Your Own Look:

Choose your bag style.  
Send us your artwork.  
For 100% full color design, speak to your sales representative.

- Minimum 5,000 per size or any 2 sizes, minimum 3000 per size

- Add a second color for just \$0.04/ea

- For 100% ink coverage, add \$0.029/ea

- Add a rope handle for \$0.08/ea



**INK PRINT**  
One color included in the price of the bag



**FOIL PRINT**  
Add \$0.06/ea. per side

Estimated lead time: 12 - 14 weeks for printed items from approved art.

# IN STOCK

## Kraft Paper Bag With Die Cut Handles



70% Recycled Material

Buy 2500 Bags with Ink Print  
Get FREE plates and Set Up

printed 1, 1 side



### The Mission Green Sustainable Solution for single-use plastic merchandise shoppers.

- 70% post-consumer recycled material
- Durable reinforced handles
- 90 gsm kraft paper
- 125 gsm white kraft paper

CODE	SIZE (inches)	CASE	PRICE/EACH		Free Plates and Set Up	
			250+	1000+	1000 Ink Printed	2500 Ink Printed
23101300WF	10 x 3.14 x 13 x 3.14 - White	250	\$0.24	\$0.22	\$399.00	\$849.00
23141800WF	14 x 3.14 x 18 x 3.14 - White	250	\$0.32	\$0.28	\$529.00	\$975.00
23101312KF	10 x 3.14 x 13 x 3.14 - Kraft	250	\$0.21	\$0.19	\$399.00	\$875.00
23141812KF	14 x 3.14 x 18 x 3.14 - Kraft	250	\$0.27	\$0.24	\$429.00	\$899.00

Estimated lead time: 2 - 3 weeks for printed items from approved art.

Available Colors

**DIGITAL PRINT**  
100+ \$1.25 each  
1000+ 99¢ each  
300 bags minimum

**FOIL PRINT**  
100+ 29¢ each  
1000+ 26¢ each  
2500+ 22¢ each

**INK PRINT**  
100+ 28¢ each  
1000+ 24¢ each  
2500+ 20¢ each



12KF - Kraft

00WF - White

All print orders subject to set-up charges. Applicable artwork, and plate charges may apply. See page 130.



# CREATE YOUR OWN LOOK

## Full Color Simply Paper Shoppers

Make a creative impression...  
the combinations are endless!



**Create Your Own Look:**  
Choose your bag style.  
Send us your artwork.  
For 100% full color  
design, speak to your  
sales representative.



96% Recycled Material

- Minimum 5,000 per size or any 2 sizes, minimum 3000 per size
- Add a second color for just \$0.04/ea
- For 100% ink coverage, add \$0.029/ea
- Add a rope handle for \$0.08/ea

Estimated lead time: 12 - 14 weeks for printed items from approved art.

**INK PRINT**  
One color included in the price of the bag

**FOIL PRINT**  
Add \$0.06/ea. per side

# IN STOCK Paper Shoppers



96%  
Post Consumer  
Waste

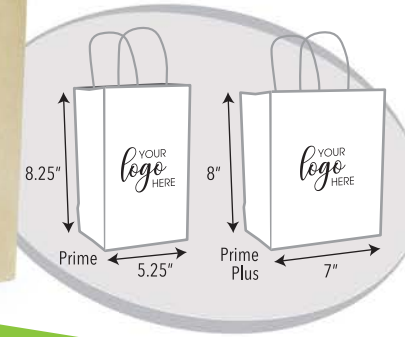

## Paper Twist Handle Shopping Bags

Sturdy, durable. Our best value bags.

- 96% post-consumer waste
- 80 gsm paper
- North American manufacturer
- New Prime Plus size - Better value
- In Stock and ready for customization

**NEW SIZE  
BETTER  
VALUE!**

**Prime Plus\*** size:  
7" x 3.5" x 8" x 3.5"  
\*Replaces our Prime size of  
5.25" x 3.5" x 8.25" x 3.5"

## Simply Paper Shoppers

Kraft with paper twist handles, print 1 color on 2 sides <25%

TYPE	SIZE (inches)	CASE PACK	PRICE/EACH		
			5,000	10,000	Any 2 Sizes Min. 3000 per size
Prime	5.25 x 3.5 x 8.25	250	\$0.275	\$0.255	\$0.320
Petite	8 x 4 x 10	250	\$0.295	\$0.275	\$0.345
Vanity	10 x 5 x 13	250	\$0.330	\$0.310	\$0.390
Celebrity	13 x 6 x 15.5	250	\$0.390	\$0.365	\$0.480
Fashion	16 x 6 x 12	250	\$0.360	\$0.340	\$0.400
Saville	16 x 6 x 19	200	\$0.445	\$0.410	\$0.495
Universal	18 x 6 x 19	200	\$0.455	\$0.420	\$0.525
Wine	5.25 x 3.5 x 13	250	\$0.295	\$0.275	\$0.375

White with paper twist handles, print 1 color on 2 sides <25%

TYPE	CASE SIZE (inches)	PACK	PRICE/EACH		
			5,000	10,000	Any 2 Sizes Min. 3000 per size
Prime	5.25 x 3.5 x 8.25	250	\$0.320	\$0.300	\$0.360
Petite	8 x 4 x 10	250	\$0.350	\$0.330	\$0.390
Vanity	10 x 5 x 13	250	\$0.420	\$0.390	\$0.480
Celebrity	13 x 6 x 15.5	250	\$0.500	\$0.460	\$0.560
Fashion	16 x 6 x 12	250	\$0.450	\$0.420	\$0.510
Saville	16 x 6 x 19	200	\$0.590	\$0.550	\$0.670
Universal	18 x 6 x 19	200	\$0.600	\$0.560	\$0.680
Wine	5.25 x 3.5 x 13	250	\$0.380	\$0.350	\$0.470

CODE	TYPE	SIZE (inches)	CASE	12 - Kraft PRICE/EACH		00 - White PRICE/EACH		Tints & Pinstripe PRICE/EACH		Metallics PRICE/EACH	
				250+	1000+	250+	1000+	250+	1000+	250+	1000+
230508	Prime Plus	7 x 3.5 x 8 x 3.5	250	\$0.28	\$0.24	\$0.34	\$0.27	\$0.50	\$0.42	\$0.54	\$0.46
230809	Petite	8 x 4.5 x 10.75 x 4.5	250	\$0.32	\$0.28	\$0.34	\$0.30	\$0.52	\$0.47	\$0.57	\$0.51
230914	Vanity	10 x 5 x 13 x 5	250	\$0.50	\$0.34	\$0.38	\$0.34	-	-	-	-
231315	Celebrity	13 x 6 x 15 x 6	250	\$0.40	\$0.37	\$0.45	\$0.42	-	-	-	-
231611	Fashion	16 x 6 x 12 x 6	250	\$0.39	\$0.37	\$0.42	\$0.38	\$0.51	\$0.45	\$0.55	\$0.47
231619	Saville	16 x 6 x 19 x 6	200	\$0.50	\$0.43	\$0.57	\$0.50	\$0.69	\$0.63	\$0.70	\$0.64
231819	Universal	18 x 7 x 18.75 x 7	200	\$0.52	\$0.46	\$0.55	\$0.50	-	-	-	-
230513	Wine Shopper	5.25 x 3.5 x 13	250	\$0.43	\$0.41	\$0.43	\$0.41	-	-	-	-

### Kraft and White



### Tints and Pinstripe on Kraft



### Metallics



**DIGITAL PRINT**  
100+ \$1.25 each  
1000+ 99¢ each  
300 bags minimum

**INK PRINT**  
100+ 28¢ each  
1000+ 24¢ each  
2500+ 20¢ each

**FOIL PRINT**  
100+ 29¢ each  
1000+ 26¢ each  
2500+ 22¢ each

Please allow 2 - 3 weeks for printed items from approved art.

All print orders subject to set-up charges. Applicable artwork, and plate charges may apply. See page 130.



# SPECIAL ORDER

## Paper Shoppers

Available Colors

### Tints on Kraft



### Pinstripe on Kraft



## Tints and Pinstripe on Kraft

- 120 gsm paper
- Minimum order 1000 bags per size/color

CODE	TYPE	SIZE (Inches)	MIN ORDER	PRICE/EACH	
				1000+	1000+
230508 __(_)	Prime	5.25 x 3.5 x 8.25 x 3.5	1000	\$0.52	
230809 __(_)	Petite	8.25 x 4.75 x 10.5 x 4.75	1000	\$0.46	
231611 __(_)	Fashion	16 x 6 x 12.5 x 6	1000	\$0.57	
231619 __(_)	Saville	16 x 6 x 19 x 6	1000	\$0.70	

\* Not available in Saville

Please allow 4 - 5 weeks for printed items from approved art.

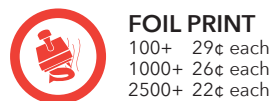

**FOIL PRINT**  
100+ 29¢ each  
1000+ 26¢ each  
2500+ 22¢ each

## San Francisco Shoppers

All bag sizes available in these colors, unless otherwise noted.



Please allow 4 - 5 weeks for printed items from approved art.



**FOIL PRINT**  
100+ 29¢ each  
1000+ 26¢ each  
2500+ 22¢ each



### Matching 2-Piece Berkeley Nest Boxes in 4 Sizes

See page 48 for more information.

- Shopping bag with fold over top turn
- No top board, no bottom board
- 150 gsm gloss paper
- Minimum order is 100 per size

CODE	TYPE	SIZE (inches)	CASE	PRICE/EACH		
				100+	500+	1000+
A 245803 __	Small	7 x 3 x 7 x 3	100	\$0.60	\$0.57	\$0.54
B 245804 __	Medium	10 x 4 x 10 x 4	100	\$0.74	\$0.70	\$0.65
C 245811 __	Large	16 x 6 x 12 x 6	100	\$0.99	\$0.91	\$0.85

# IN STOCK

## Paper Shoppers



## Damask Paper Shoppers

- 120 gsm paper

CODE	TYPE	SIZE (inches)	CASE	PRICE/EACH	
				100+	1000+
23080915D	Petite	8 x 4 x 10 x 4	100	\$0.55	\$0.46
23101315D	Vanity	10 x 5 x 13 x 5	100	\$0.59	\$0.50
23161215D	Fashion	16 x 6 x 12 x 6	100	\$0.69	\$0.60



**DIGITAL PRINT**  
100+ \$1.25 each  
1000+ 99¢ each  
300 bags minimum



**INK PRINT**  
100+ 28¢ each  
1000+ 24¢ each  
2500+ 20¢ each



**FOIL PRINT**  
100+ 29¢ each  
1000+ 26¢ each  
2500+ 22¢ each  
Please allow 2 - 3 weeks for printed items from approved art.



## Merchandise Die Cut Bags

- Reinforced fold-over handle plus side gusset
- 80 gsm paper

CODE	SIZE (inches)	CASE	PRICE/EACH
23081275	8 x 2 x 12	500	\$0.246
23101575	10 x 2 x 15	500	\$0.280
23141875	14 x 4 x 18	250	\$0.392

## Merchandise Bags

- 110 gsm paper



**DIGITAL PRINT**  
100+ \$1.25 each  
1000+ 99¢ each  
300 bags minimum



**INK PRINT**  
100+ 28¢ each  
1000+ 24¢ each  
2500+ 20¢ each



**FOIL PRINT**  
100+ 29¢ each  
1000+ 26¢ each  
2500+ 22¢ each  
Please allow 2 - 3 weeks for printed items from approved art.

All print orders subject to set-up charges. Applicable artwork, and plate charges may apply. See page 130.

All print orders subject to set-up charges. Applicable artwork, and plate charges may apply. See page 130.



# CREATE YOUR OWN LOOK

## Full Color Simply Poly Shopping Bags

Make a creative impression...  
the combinations are endless!



### Printed Poly Shopping Bags

Customize simply and affordably.

CODE	TYPE	White or Clear Poly: PRICE/EACH			Colored Poly: PRICE/EACH			STANDARD PRINT SIZE
		3,000	5,000	10,000	3,000	5,000	10,000	
550907	Small Gift	\$0.355	\$0.301	\$0.287	\$0.373	\$0.317	\$0.309	5" wide
550414	Wine	\$0.504	\$0.394	\$0.374	\$0.569	\$0.435	\$0.404	2.5" wide
550810	Petite	\$0.369	\$0.313	\$0.250	\$0.386	\$0.329	\$0.312	5" wide
551612	Fashion	\$0.632	\$0.539	\$0.511	\$0.666	\$0.612	\$0.533	9" wide
551816	Majestic	\$0.775	\$0.660	\$0.626	\$0.814	\$0.693	\$0.657	10" wide



#### Create Your Own Look:

Choose your bag style.  
Send us your artwork.  
For 100% full color  
design, speak to your  
sales representative.

- Print two sides in 1 ink color (maximum 25% ink coverage)
- Constructed of 3.0 mil high density poly
- Coordinating poly loop handles included in price
- Poly Shoppers minimum quantity 3,000 per size

Estimated lead time: 14 - 16 weeks for printed items from approved art.



#### INK PRINT

One color included in the price of the bag

### No Plate Charges\* \*Does not include process plates.

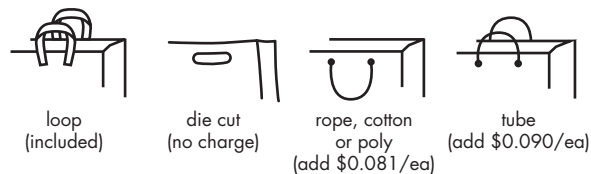

### 3000 Printed Shopping Bags for only \$1065.00

White, petite: 8" x 4" x 10" x 4" printed 1 color, 2 sides with loop handles

# IN STOCK Poly Shoppers



Available Colors



### Frosted Brights and Clear Translucent Bags

- 2.0 mil Clear HDPE merchandise, and 3.0 mil Clear HDPE shoppers
- Minimum order one case pack
- Please allow 2 - 3 weeks for printed items from approved art

CODE	TYPE	GAUGE	SIZE (in)	CASE	PRICE/EACH
A 550912 __	Merchandise	2.0	9 x 12	1000	\$0.08
B 551418 __	Merchandise	2.0	14 x 18 + 3	1000	\$0.19
C 550810 __	Petite Shopper	3.0	8 x 4 x 10 x 4	250	\$0.33
D 551612 __	Fashion Shopper	3.0	16 x 6 x 12 x 6	250	\$0.46
E 551816 __	Majestic Shopper	3.0	18 x 6 x 16 x 6	250	\$0.51

Estimated lead time: 2 - 3 weeks for printed items from approved art.



**FOIL PRINT**  
100+ 29¢ each  
1000+ 26¢ each  
2500+ 22¢ each

### Celestial Pattern High Density Poly

- 2.0 mil Clear HDPE merchandise, and 3.0 mil Clear HDPE shoppers.
- Please allow 2 - 3 weeks for printed items from approved art.
- Minimum order one case pack.

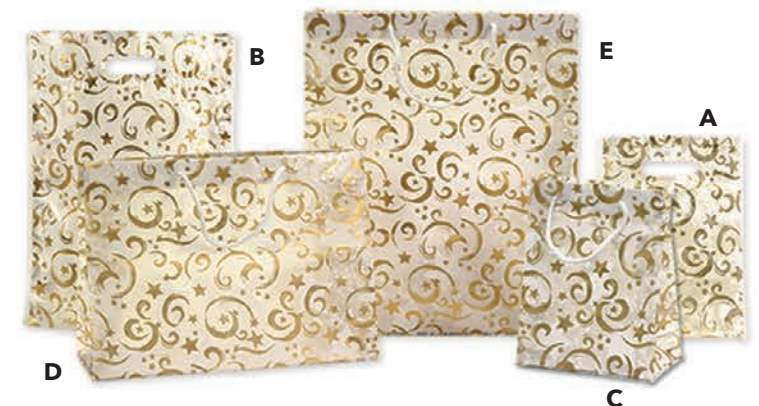

No printing available.

CODE	TYPE	SIZE (inches)	CASE	PRICE/EACH
A 55091241C	Merchandise	9 x 12	1000	\$0.10
B 55141841C	Merchandise	14 x 18 + 3	1000	\$0.20
C 55081041C	Petite Shopper	8 x 4 x 10 x 4	250	\$0.43
D 55161241C	Fashion Shopper	16 x 6 x 12 x 6	250	\$0.60
E 55161941C	Saville Shopper	16 x 6 x 19 x 6	250	\$0.71

All print orders subject to set-up charges. Applicable artwork, and plate charges may apply. See page 130.



# CREATE YOUR OWN LOOK

## Full Color Simply Poly Merchandise Bags

Make a creative impression...  
the combinations are endless!



# IN STOCK

## Poly Shoppers



## Poly-Merchandise Bags

Large or small, we've got a bag for you!

CODE	SIZE (in)	White or Clear Poly: PRICE/EACH			Colored Poly: PRICE/EACH			STANDARD PRINT SIZE
		3,000	5,000	10,000	3,000	5,000	10,000	
550912	9 x 12	N/A	\$0.098	\$0.91	N/A	\$0.099	\$0.094	6" wide
551114	11 x 14	N/A	\$0.115	\$0.108	N/A	\$0.123	\$0.114	7" wide
551216	12 x 16 + 3	N/A	\$0.140	\$0.126	N/A	\$0.147	\$0.138	8" wide
551416	14 x 16 + 3	\$0.229	\$0.196	\$0.177	\$0.244	\$0.209	\$0.189	10" wide
551720	17 x 20 + 4	\$0.313	\$0.249	\$0.225	\$0.334	\$0.263	\$0.236	12" wide
551816	18 x 16 + 4	\$0.283	\$0.227	\$0.204	\$0.298	\$0.238	\$0.214	13" wide
552020	20 x 20 + 4	\$0.345	\$0.276	\$0.249	\$0.362	\$0.290	\$0.261	14" wide
552024	20 x 24 + 4	\$0.401	\$0.321	\$0.289	\$0.411	\$0.328	\$0.295	14" wide



### Create Your Own Look:

Choose your bag style.  
Send us your artwork.  
For 100% full color  
design, speak to your  
sales representative.

- Constructed of 1.5 mil gauge poly.
- Minimum quantity 5,000 (small sizes)/ 3,000 (large sizes).
- Print two sides in 1 ink color (maximum 25% ink coverage).

Estimated lead time: 14 - 16 weeks for printed items from approved art.



### INK PRINT

One color included in the price of the bag

No Plate Charges\* \*Does not include process plates.

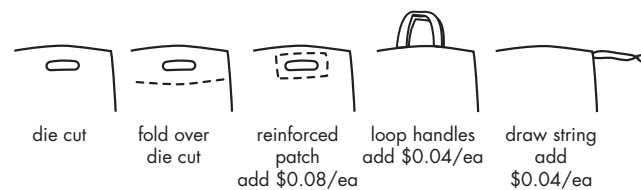

**5000 Printed Bags for only \$490.00**

white 9" x 12" printed 1 color, 2 sides with fold over die cut handles

## Foil Printed Merchandise Bags

- Constructed of 1.75 mil low density poly
- Minimum order is 1,000 per size printed, minimum one case pack, unprinted
- Foil Printing is available on one side only and is included in the price of the printed bags
- Die charge extra
- For no-print option please add N to code number

CODE	HANDLE TYPE	SIZE (inches)	CASE PACK	PRICE/EACH		
				1000 Foil Print	3000 Foil Print	1000 No Print
A 220609 __ *	Notion	6 x 9	1000	\$0.19	\$0.14	\$0.10
B 220811 __ *	Die Cut	8.25 x 11	1000	\$0.23	\$0.17	\$0.14
C 221114 __ *	Die Cut	11 x 14	1000	\$0.25	\$0.20	\$0.15
D 221418 __	Die Cut	14.5 x 18	1000	\$0.34	\$0.28	\$0.19
E 221721 __	Patch	16.5 x 20 + 4	500	\$0.40	\$0.35	\$0.22
F 222024 __	Patch	20 x 24 + 4	500	\$0.56	\$0.52	\$0.26

\* Gold available in 3 sizes only



07 Gold 15 Black 00 White 11 Blue 10 Green 12 Brown 66 Burgundy

Estimated lead time: 2 - 3 weeks for printed items from approved art.

Foil Printing is available on one side only and is included in the price of the printed bags.

All print orders subject to set-up charges. Applicable artwork, and plate charges may apply. See page 130.



# CREATE YOUR OWN LOOK

## Reusable Fabric Style Shoppers

Make a creative impression...  
the combinations are endless!



## Full Color Laminated Bags

Plates extra: \$695.00 per design/side.

Additions:

- Add matte lamination for just \$0.04/bag
- Add a carded bottom for \$0.05/bag
- Zipper top for \$0.25/bag
- Gusset print: \$0.10/bag

Shopping Bags (inches)	80 GSM NON-WOVEN SILK SCREEN PRINT ONE COLOR 2 SIDES 1"X24" HANDLES - "X" STITCH				100 GSM NON-WOVEN WITH LAMINATION PRINT 4 COLOR PROCESS 1"X24" PP WEBBING HANDLES - "X" STITCH				120 GSM PP WOVEN WITH LAMINATION PRINT 4 COLOR PROCESS 1"X24" PP WEBBING HANDLES - "X" STITCH			
	PRICE/EACH				PRICE/EACH				PRICE/EACH			
	2,000	5,000	10,000	25,000	2,000	5,000	10,000	25,000	2,000	5,000	10,000	25,000
9 x 4 x 11 x 4	\$1.25	\$0.95	\$0.89	\$0.83	\$1.34	\$0.92	\$0.78	\$0.65	\$1.34	\$0.92	\$0.78	\$0.65
11 1/4 x 4 1/4 x 12 x 4 1/4	\$1.28	\$0.98	\$0.92	\$0.86	\$1.37	\$1.02	\$0.87	\$0.73	\$1.37	\$1.02	\$0.87	\$0.73
14 x 4 x 16 x 4	\$1.37	\$1.10	\$1.04	\$0.98	\$1.43	\$1.20	\$1.05	\$0.89	\$1.43	\$1.20	\$1.05	\$0.89
16 x 6 x 12 x 6	\$1.37	\$1.10	\$1.04	\$0.98	\$1.43	\$1.20	\$1.05	\$0.90	\$1.43	\$1.20	\$1.05	\$0.90
16 x 5 x 15 x 5	\$1.40	\$1.13	\$1.07	\$1.01	\$1.48	\$1.27	\$1.12	\$0.96	\$1.48	\$1.27	\$1.12	\$0.96



### Non-woven Polypropylene

Soft, yet durable. Use this for light to medium weight loads.



### Woven Polypropylene

Our strongest material. This rigid weave will handle heavy items.

## Many more sizes available - just ask!



**Create Your Own Look:**  
Choose your bag style. Send us your artwork. For 100% full color design, speak to your sales representative.



**SILK SCREEN**  
One color included in the price of the bag

Estimated lead time: 14 - 16 weeks for printed items from approved art.



**DIGITAL PRINT**  
100+ \$1.25 each  
1000+ 99¢ each  
300 bags minimum



**FOIL PRINT**  
100+ 29¢ each  
1000+ 26¢ each  
2500+ 22¢ each

Please allow 2 - 3 weeks for printed items from approved art.

# IN STOCK

## Reusable RPET Laminated Tote



## Mission Green Sustainable solution made with 80% recycled RPET + Lamination

- 100 gsm with matte lamination
- Corner sewn style with RPET handle
- Small bag made with 7 recycled plastic bottles
- Large bag made with 11 recycled plastic bottles
- Eco-friendly, durable, recycled

RPET is known as Recycled Polyethylene Terephthalate. It's a strong, durable material constructed from 80% recycled plastic bottles.

CODE	SIZE (inches)	CASE	PRICE/EACH	
			100+	1000+
21081035R	8 x 4 x 10 x 4	100	\$1.26	\$1.01
21141635R	14 x 6 x 16 x 6	100	\$1.82	\$1.46



80% Recycled PET

All print orders subject to set-up charges. Applicable artwork, and plate charges may apply. See page 130.



# IN STOCK

## Reusable Fabric Shoppers

# SPECIAL ORDER

## Reusable Fabric Shoppers

BAGS

BAGS



### Toronto Totes

CODE	DESCRIPTION	SIZE (inches)	PACK	PRICE/EACH	
				100+	1000+
215909 __	Small Tote	9 x 5 x 12 x 5	100	\$0.92	\$0.86
215916 __	Large Tote	16 x 6 x 14 x 6	100	\$1.40	\$1.15

\* Only Gold, Silver, White and Black foil is available for printing..



15 - Black with White  
00 - White with Black

 **DIGITAL PRINT**  
100+ \$1.25 each  
1000+ 99¢ each  
300 bags minimum

 **FOIL PRINT\***  
100+ 29¢ each  
1000+ 26¢ each  
2500+ 22¢ each

Please allow 3-5 weeks for printed items from approved art.

CODE	DESCRIPTION	SIZE (inches)	PACK	PRICE/EACH	
				100+	500+
A 21141600S	Four Seasons Tote	14 x 4 x 16 x 4	100	\$1.59	\$1.29
B 21141615WF	Winter Forest Tote	14 x 6 x 16 x 6	100	\$1.59	\$1.29
C 21141629	Two-tone Non-woven Tote	14 x 6 x 16 x 6	100	\$1.39	\$1.25
D 21141615B	Black Tote with 4" gusset	14 x 4 x 16 x 4	100	\$1.39	\$0.99
E 21141655B	Black Tote with 8" gusset	14 x 8 x 16 x 8	100	\$1.49	\$1.09
F 21141609R	Red Tote with 8" gusset	14 x 8 x 16 x 8	100	\$1.49	\$1.09
G 21141675C	Large Kraft Composite Tote	14 x 6 x 16 x 6	100	\$1.59	\$1.29
H 21081075C	Small Kraft Composite Tote	8 x 4 x 10 x 4	100	\$1.29	\$0.99
I 21111315BW	Six Bottle Wine Tote	11.5 x 7.25 x 13 x 7.25	100	\$1.79	\$1.35

\* Only Gold, Silver and Black foil is available for printing.

Estimated lead time: 2 - 3 weeks for printed items from approved art.

 **DIGITAL PRINT**  
100+ \$1.25 each  
1000+ 99¢ each  
300 bags minimum

 **INK PRINT**  
100+ 28¢ each  
1000+ 24¢ each  
2500+ 20¢ each

 **FOIL PRINT**  
100+ 29¢ each  
1000+ 26¢ each  
2500+ 22¢ each

 **SCREEN PRINT**  
100+ 79¢ each  
500+ 60¢ each  
1000+ 50¢ each

All print orders subject to set-up charges. Applicable artwork, and plate charges may apply. See page 130.

All print orders subject to set-up charges. Applicable artwork, and plate charges may apply. See page 130.



# CREATE YOUR OWN LOOK

## Non-Woven Garment Covers

Great for resale or promotions!

CODE	SIZE (in.)	CASE	PRICE/EACH UNPRINTED
A 21244015	24 x 42	100	\$2.34
B 21245415	24 x 54	100	\$2.94
C 21247215	24 x 72 + 4	100	\$3.79



Silk screen set-up charge: \$65.00

Please allow 2-3 weeks for printed items from approved art.



### SCREEN PRINT

100+ 79¢ each  
500+ 60¢ each  
1000+ 50¢ each

# SPECIAL ORDER

## Non-Woven Garment Covers

Custom Colors Available

SIZE	DESCRIPTION	PRICE/EACH	
		1000	3000
24 x 42	Suit Bag	\$2.09	\$1.99
24 x 54	Coat Bag	\$2.59	\$2.38
24 x 72 + 4	Gown - Black	\$3.49	\$2.99

Please allow 14 - 16 weeks from approved art for delivery. Minimum 1000 per size.



Pricing includes printing on one side with one color.

## Poly Garment Covers on Rolls

Please allow 6 - 8 weeks from approved art for delivery. Minimum 5 rolls per size. Plate costs apply.

CODE	DESCRIPTION	SIZE (inches)	WHITE ROLL WITH ONE COLOR PRINT PRICE/ROLL		COLOR ROLL WITH ONE COLOR PRINT PRICE/ROLL	
			5 ROLLS	10 ROLLS	5 ROLLS	10 ROLLS
212140 __	Suit 450/roll	21 x 3 x 40	\$296.00	\$199.00	\$369.00	\$226.00
212154 __	Coat 333/roll	21 x 3 x 54	\$296.00	\$199.00	\$369.00	\$226.00
212173 __	Dress 250/roll	21 x 3 x 72	\$296.00	\$199.00	\$369.00	\$226.00

Pricing includes printing on one side with one color.



**In Stock**  
One roll, white with no print for \$199.00 any size.  
21214000S, 21215400S, 21217300S

Roll colors available: White 00, Black 15, Gray 08, Ivory 16, Beige 39, Navy 11, Green 10. 1.0 mil LDPE. Minimum 5 rolls, printed or plain.

Print colors available: Black, Blue, Brown, Burgundy, Red, Green, Orange, Yellow. For metallic print - Add \$29.00/roll

All print orders subject to set-up charges. Applicable artwork, and plate charges may apply. See page 130.

# BOXES GIFT AND APPAREL

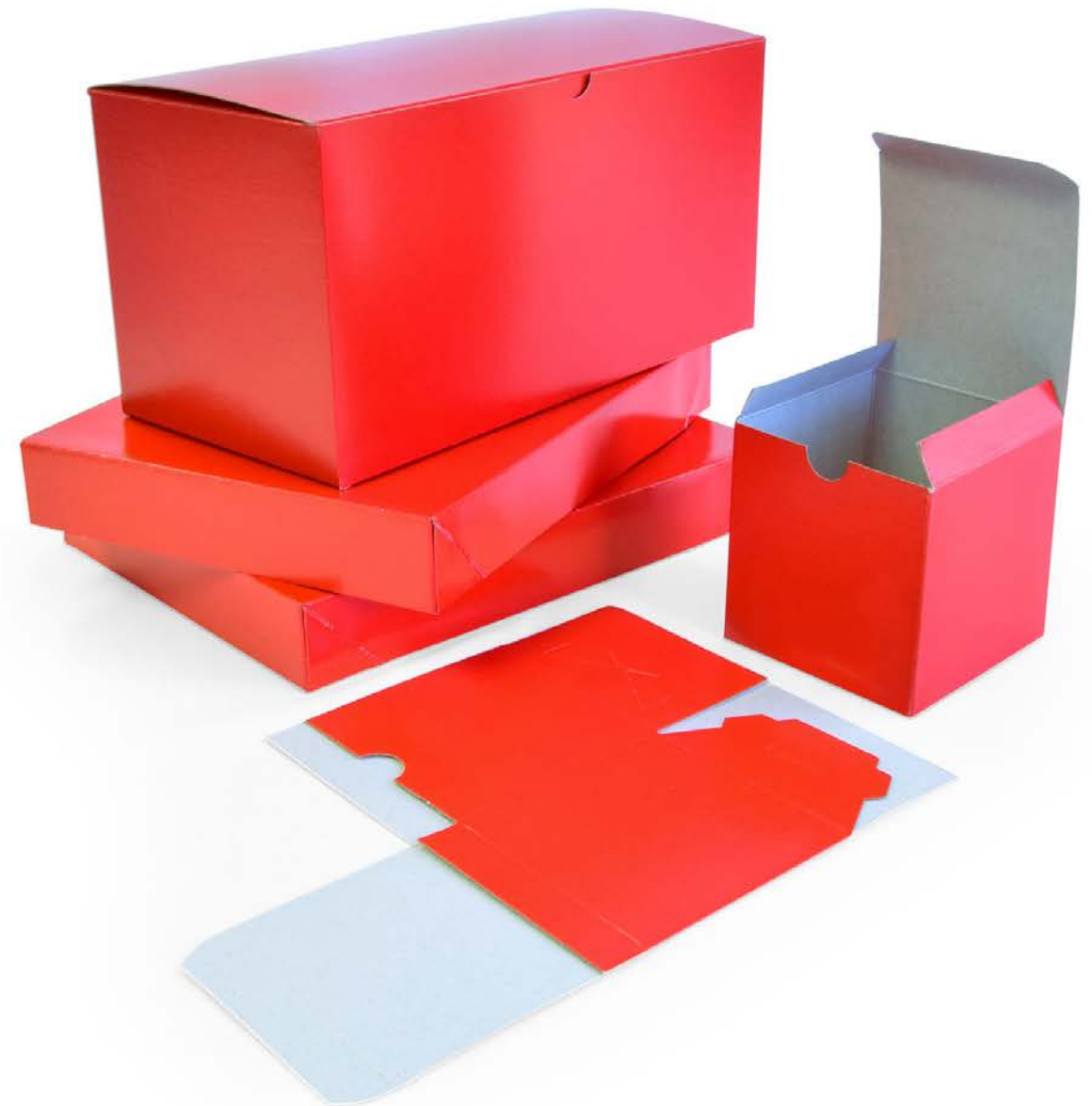



# IN STOCK

# SPECIAL ORDER

GIFT AND APPAREL BOXES

GIFT BOXES

## White Foldings

- Our most economical option ships flat and stores flat
- Please allow 2 - 3 weeks for printed items from approved art



CODE	DESCRIPTION	SIZE (inches)	CASE	PRICE/EACH	
				100+	1000+
32058003	G58 Baby Mugs	3.5 x 3.5 x 2	100	\$0.23	\$0.21
32001003	G1 Mugs	4 x 4 x 4	100	\$0.24	\$0.22
32002003	G2 Cups and Saucers	6 x 6 x 4	100	\$0.34	\$0.29
32043003	G43 Bowls, etc.	10 x 8 x 4	100	\$0.48	\$0.45
32033003	G33 Bowls, etc.	10 x 10 x 6	100	\$1.12	\$1.00
32005003	G5 Teapots, etc.	8 x 8 x 5	100	\$0.69	\$0.62
32006003	G6 Teapots, etc.	8 x 8 x 8	100	\$1.01	\$0.91
32048003	G48 Fork, Knife, Spoon	13 x 4 x 2	100	\$1.19	\$1.07
32036003	G36 Casseroles	11 x 11 x 4.5	50	\$0.92	\$0.83
32013003	G13 Plates	5 x 5 x 2	100	\$0.33	\$0.28
32004003	G4 Plates	8 x 8 x 2	100	\$0.58	\$0.49
32008003	G8 Plates	11 x 11 x 2	100	\$0.69	\$0.62
32009003	G9 Plates	13.5 x 13.5 x 2	100	\$0.95	\$0.87
32040003	G40 Plates	15 x 15 x 2	50	\$1.32	\$1.20
32003003	G3 All purpose	7 x 4 x 3	100	\$0.40	\$0.37
32010003	G10 All purpose	9 x 4.5 x 4.5	100	\$0.44	\$0.39
32038003	G38 All purpose	12 x 4 x 4	100	\$0.57	\$0.52
32041003	G41 All purpose	10 x 7 x 7	100	\$0.83	\$0.78
32224003	G24* 2-Piece Boxes - Base	6 x 6 x 10	100	\$1.46	\$1.32
32124003	G24* 2-Piece Boxes - Lid		100		

Please allow 2 - 3 weeks for printed items from approved art.

**FOIL PRINT**  
50/100+ 29¢ each  
1000+ 26¢ each  
2500+ 22¢ each

**INK PRINT**  
50/100+ 28¢ each  
1000+ 24¢ each  
2500+ 20¢ each

\* Must be ordered together. Pricing shown is for base and lid combined.

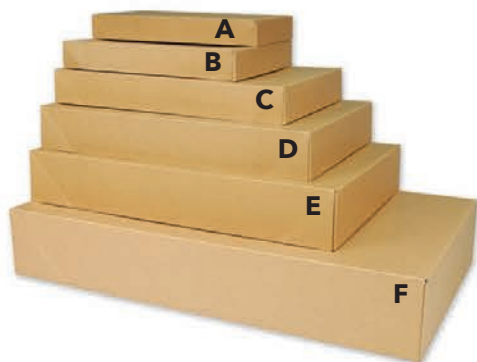

## Apparel Boxes

Seven sizes and nine colors to choose from!

- Minimum order quantity is one case pack
- Please allow 2 - 3 weeks for printed in stock boxes from approved art

CODE	DESCRIPTION	SIZE (inches)	CASE PACK	WHITE OR KRAFT PINSTRIPE		COLORS	
				PRICE /EACH 100+	1000+	PRICE /EACH 100+	1000+
A 32072	Glove/Sock*	11.5 x 5.5 x 1.5	100	\$0.49	\$0.43	-	-
B 32073	Lingerie/T-Shirt	11.5 x 8.5 x 1.625	100	\$0.54	\$0.48	\$0.94	\$0.83
C 32075	Shirt	15 x 9.5 x 2	100	\$0.56	\$0.49	\$1.23	\$1.14
D 32076	Sweater/Dress	17 x 11 x 2.5	50	\$0.90	\$0.82	\$1.67	\$1.56
E 32077	Jacket/Robe	19 x 12 x 3	50	\$1.22	\$1.13	\$2.00	\$1.90
F 32078	Coat/Gown	24 x 14 x 4	25	\$2.06	\$2.00	\$2.90	\$2.79
G 32071	Sweater (white only) (not shown)	15 x 11 x 4.5	50	\$1.64	\$1.59	-	-

\* Kraft pinstripe/White only

**FOIL PRINT**  
25/50/100+ 29¢ each  
1000+ 26¢ each  
2500+ 22¢ each

**INK PRINT**  
25/50/100+ 28¢ each  
1000+ 24¢ each  
2500+ 20¢ each

### IN STOCK COLORS



### SPECIAL ORDER COLORS



Please allow 3-5 weeks for printed boxes from approved art.

## Tuckit® Folding Gift Boxes



- Our glued boxes fold and tuck together for a solid bottom
- 15 sizes available

CODE	SIZE (inches)	PACK	ECONO WHITE PRICE/EACH		KRAFT & COLORS PRICE/EACH		GLOSS COLORS PRICE/EACH	
			100+	1000+	100+	1000+	100+	1000+
# 334103	3 x 3 x 2	100	\$0.27	\$0.24	\$0.27	\$0.24	N/A	N/A
* 334180	3 x 3 x 3	100	\$0.28	\$0.26	\$0.30	\$0.27	N/A	N/A
334111	4 x 4 x 4	100	\$0.30	\$0.27	\$0.31	\$0.29	\$0.41	\$0.37
334115	6 x 4.5 x 4.5	100	\$0.35	\$0.31	\$0.44	\$0.40	\$0.52	\$0.47
334113	6 x 6 x 4	100	\$0.43	\$0.39	\$0.47	\$0.43	\$0.71	\$0.64
334114	6 x 6 x 6	100	\$0.49	\$0.44	\$0.55	\$0.50	\$0.72	\$0.65
334120	8 x 8 x 3.5	100	\$0.72	\$0.66	\$0.77	\$0.70	\$1.09	\$0.99
• 334121	8 x 8 x 6	50	\$1.18	\$1.07	N/A	N/A	N/A	N/A
334119	9 x 4.5 x 4.5	100	\$0.58	\$0.53	\$0.61	\$0.56	\$0.74	\$0.67
# 334183	10 x 5 x 4	100	\$0.63	\$0.57	\$0.66	\$0.60	N/A	N/A
334124	10 x 10 x 6	50	\$1.34	\$1.22	\$1.51	\$1.37	\$2.44	\$2.22
334131	12 x 6 x 6	50	\$1.37	\$1.25	\$1.50	\$1.36	\$1.97	\$1.79
334125	12 x 12 x 2.5	50	\$0.93	\$0.84	\$1.09	\$0.99	\$1.70	\$1.55
# 334136	12 x 12 x 5.5	50	\$1.61	\$1.46	\$1.68	\$1.53	\$2.59	\$2.36
# 334186	14 x 6 x 6	50	\$1.10	\$0.96	\$1.73	\$1.57	N/A	N/A

- \* not available in 56-Purple
- # only available in 12P-Kraft Pinstripe and 00-Econo white
- only available in 00-Econo White

100% recycled content (min. 35% post consumer) - kraft excluded

**FOIL PRINT**  
50/100+ 29¢ each  
1000+ 26¢ each  
2500+ 22¢ each



Bottom tucks into place for a secure fit.

Please allow 3 - 5 weeks for printed items from approved art.

## Pop-Up Folding Gift Boxes

- Our most convenient folding gift box
- Simple automatic bottom closure

CODE	SIZE (inches)	CASE	PRICE/EACH		003 WHITE	153 BLACK	753 KRAFT
			100+	1000+			
34058	3 x 3 x 3	100	\$0.25	\$0.24			
34001	4 x 4 x 4	100	\$0.27	\$0.25			
34013	5 x 5 x 3.5	100	\$0.40	\$0.38			
34064	6 x 4.5 x 4.5	100	\$0.41	\$0.39			
34002	6 x 6 x 4	100	\$0.42	\$0.40			
34066	6 x 6 x 6	100	\$0.45	\$0.43			
34003	7 x 4 x 3	100	\$0.47	\$0.45			
34077	7 x 7 x 7	100	\$0.61	\$0.62			
34004	8 x 8 x 2	100	\$0.72	\$0.68			
34088	8 x 8 x 3.5	100	\$0.67	\$0.64			
34010	9 x 4.5 x 4.5	100	\$0.49	\$0.46			
34008	10.5 x 10.5 - 2PC.	50	\$0.86	\$0.81			
34033	10 x 10 x 6	50	\$1.27	\$1.21			
34026	10 x 10 x 6	50	\$1.28	\$1.22			
34009	12 x 6 x 6 - 2PC.	50	\$0.97	\$0.92			
34038	12 x 4 x 4	50	\$0.68	\$0.65			
34034	12 x 12 x 5.5 - 2PC.	50	\$1.67	\$1.59			
34051	14 x 6 x 6	50	\$1.31	\$1.24			
34039	14 x 14 x 5 - 2PC.	25	\$1.75	\$1.66			
34084	8 x 8 x 14 - 2PC.	50	\$2.12	\$2.01			



Bottom interlocks for easier assembly.



Please allow 3 - 5 weeks for printed items from approved art.

**FOIL PRINT**  
25/50/100+ 29¢ each  
1000+ 26¢ each  
2500+ 22¢ each



# SPECIAL ORDER

GIFT BOXES



## Malibu Magnetic Gift Box

These boxes are trending! Dual purpose great for gifting and use after. Perfect for e-commerce business subscriptions.

- Smooth paper covering
- Magnetic closures
- Four colors and three sizes
- Inserts available via special order. Ask your representative
- Please allow 3 - 5 weeks for printed items from approved art

CODE	DESCRIPTION	SIZE (in)	CASE	PRICE/EACH
454103 __	Small	8.5 x 2.75 x 1.625	100	\$2.54
454104 __	Medium	7.25 x 5.5 x 1.375	60	\$3.49
454116 __	Large	10.75 x 7.125 x 1.625	40	\$4.14

Please allow 3-5 weeks for printed items from approved art.



**FOIL PRINT**  
40/60/100+ 29¢ each  
1000+ 26¢ each  
2500+ 22¢ each



## Giftalicious Pop-up Boxes

Lid, ribbon and gift tag too! The perfect solution for those who don't like to wrap. Works for jewelry, socks, even T's.

- One piece gift box with grosgrain ribbon & tag included
- Made with recycled material. Recyclable and biodegradable
- Not food grade
- Please allow 3 - 5 weeks for printed items from approved art

CODE	DESCRIPTION	SIZE (in)	CASE PACK	PRICE/EACH
344111 __	Mini	3 x 3 x 3.5	100	\$0.90
344129 __	Small	4 x 4 x 4.75	100	\$1.04
344130 __	Medium	5 x 5 x 6*	100	\$1.59

Please allow 3-5 weeks for printed items from approved art.



**FOIL PRINT**  
100+ 29¢ each  
1000+ 26¢ each  
2500+ 22¢ each



\* 99-Trellis is not available in the 5 x 5 x 6" size.

# E-Commerce





# CREATE YOUR OWN LOOK



Four color process print available. Please inquire.

## Custom E-Commerce Gift Boxes

Go above and beyond to impress customers and exceed their expectations by delivering more than just a product, but also an experience.

- Please allow 12 - 14 weeks for printed items from approved art

SIZE (inches)	FLEXPRI - 1 COLOR PRICE/EACH		
	500	1,000	2500
10 x 6 x 4	\$5.20	\$3.25	\$2.22
11.125 x 8.75 x 4	\$5.69	\$3.65	\$2.60
14.5 x 7.25 x 5	\$5.88	\$3.97	\$2.95
17 x 12 x 4.25	\$6.22	\$4.51	\$3.58
17.125 x 11.125 x 2	\$6.14	\$4.22	\$3.17

## NO PLATE CHARGES!

Pricing includes printing on one side.



### Create Your Own Look:

Choose your box style. Send us your artwork. For 100% full color design, speak to your sales representative.



Ask your rep for details on personalizing your e-commerce Mailers.

SIZE (inches)	1 COLOR/2 SIDES PRICE/EACH			2 COLOR/2 SIDES PRICE/EACH			4 COLOR PROCESS PRICE/EACH		
	10,000	25,000	PLATE CHARGE	10,000	25,000	PLATE CHARGE	10,000	25,000	PLATE CHARGE
9 x 12 + 2	\$0.08	\$0.05	\$75.00	\$0.11	\$0.06	\$150.00	\$0.19	\$0.09	\$400.00
12 x 15 1/2 + 2	\$0.11	\$0.08	\$75.00	\$0.13	\$0.09	\$150.00	\$0.22	\$0.12	\$400.00
14 1/2 x 19 + 2	\$0.14	\$0.11	\$100.00	\$0.17	\$0.12	\$120.00	\$0.26	\$0.15	\$440.00
19 x 24 + 2	\$0.21	\$0.17	\$120.00	\$0.24	\$0.19	\$180.00	\$0.34	\$0.22	\$640.00

# IN STOCK

Deliver the 'in-store' experience to your customer's door.

## Jewelry Boxes

For Geo, Velocity and Horizon packaging.

- Kraft boxes with black or metallic bronze interior
- Black flock inserts available to fit Gold Galleria, Horizon, Geo or Velocity jewelry packaging\*
  - Reversible
- Minimum case pack 25



15B - Black

87B - Metallic Bronze

\* Inserts can be special ordered to fit any of our other jewelry packaging collections. Contact your sales representative for a quote.

Minimum order: 100 per size

Please allow 2 - 3 weeks for printed items from approved art.



**FOIL PRINT**  
25+ 29¢ each  
1000+ 26¢ each  
2500+ 22¢ each

CODE	DESCRIPTION	SIZE (inches)	PRICE/EACH	
			25+	250+
450505 ___	Small	5.75 x 5.75 x 2.5	\$1.25	\$1.18
451010 ___	Large	10.25 x 10.25 x 2.5	\$2.50	\$2.30
<b>Gold Galleria/Horizon Inserts</b>				
69221003H	Ring to fit small box		\$0.50	\$0.46
69622003H	T-pad to fit small box		\$0.50	\$0.46
69693003H	bracelet to fit large box		\$0.82	\$0.65
69673003H	necklace to fit large box		\$0.82	\$0.65
<b>Geo Inserts</b>				
69221153G	Ring to fit small box		\$0.50	\$0.46
69283153G	T-pad to fit small box		\$0.50	\$0.46
69293153G	Bracelet to fit large box		\$0.82	\$0.65
69273153G	Necklace to fit large box		\$0.82	\$0.65
<b>Velocity Inserts</b>				
69321153V	Ring to fit small box		\$0.50	\$0.46
69383153V	Utility pad to fit small box		\$0.50	\$0.46
69393153V	Bracelet to fit large box		\$0.82	\$0.65
69373153V	Necklace to fit large box		\$0.82	\$0.65



02B - Light Blue

93C - Charcoal

A variety of gift item sizes for your customer's unboxing experience.

## Gift Boxes

- Kraft boxes with grey or light blue interior
  - Reversible
- Minimum case pack 25

Please allow 2 - 3 weeks for printed items from approved art.



**FOIL PRINT**  
25+ 29¢ each  
1000+ 26¢ each  
2500+ 22¢ each

CODE	DESCRIPTION	SIZE (inches)	PRICE/EACH	
			25+	250+
450606 ___	Small	6 x 6 x 4	\$1.29	\$1.04
451010 ___	Medium	10 x 10 x 6	\$2.89	\$2.31
451015 ___	Large	15 x 10 x 4	\$3.10	\$2.48
451712 ___	X-Large	17 x 12 x 5	\$3.50	\$2.80
451815 ___	XX-Large	18 x 15 x 6	\$4.46	\$3.57

All print orders subject to set-up charges. Applicable artwork, and plate charges may apply. See page 130.



# CREATE YOUR OWN LOOK

## Eco-Friendly, Recyclable E-Commerce Packaging

- Choose your mailer size and style.
- Request a quote from your Sales Representative for full color design.
- Send us your artwork.



50% Recycled Shell  
Made in the US

### Why does custom branding your eco-friendly mailers matter?

- Opportunity to impact category dominance, sales growth, brand equity and customer loyalty.
- Ensure safe product delivery while creating a memorable e-commerce experience for your customers.

### Wondering how eco-friendly packaging can strengthen your brand?

- 75% of customers emphasize their desire to receive products in eco-friendly packaging.
- 48% of consumers feel that packaging reflects the value of the shipment - the better the packaging, the better the product.
- 52% of consumers are likely to make repeat purchases from an online merchant that delivers their products in "thoughtful packaging".
- 83% of consumers would share an image of a delivery via social media if it arrived in unique, branded packaging.

Product Description	Minimum Qty	Price	Print Type
Recycled Poly Mailers	25,000+	Contact for Quote	Multi-color Ink Print Full Bleed
Padded Paper Mailers	40,000+	Contact for Quote	Multi-color Ink Print Full Bleed
Paper Apparel Mailers	10,000+	Contact for Quote	Multi-color Ink Print Full Bleed
Rigid Paper Mailers	10,000+	Contact for Quote	Multi-color Ink Print Full Bleed
Bubble Poly Mailers	25,000+	Contact for Quote	Multi-color Ink Print Full Bleed

• Lead Times: 4-6 Weeks after artwork approval.

#### Artwork Specifications:

- Only accept Vector\* art files (e.g. PDF, .AI, .EPS, and .SVG file types)
- Mailers can be printed on both sides
- All fonts must be outlined
- All supporting files must be embedded
- Artwork must remain in artwork bounding box
- Minimum stroke weight: 1pt - Minimum reversed out stroke weight: 2pt
- Minimum Font Size:
- Positive: 10 pt. Helvetica.
- Negative (reversed out): 16 pt. Helvetica.

#### For Proofing:

- Please note: There is no way to see the true PMS color on a monitor. Proof colors will vary from monitor to monitor and should serve only as a reference. For an accurate representation of print color, you will need to review a PMS coated/uncoated swatch books. Printing the proof with a digital printer will not give you an accurate representation of color because the conversion from PMS to CMYK is not perfect.
- PDF previews may render differently in browser previews and phones
- Once proofs have been approved, any costs incurred for production and reprinting are the responsibility of the customer.



# FINISHING TOUCHES

## RIBBON, TISSUE, WRAP AND SEALS





# CREATE YOUR OWN LOOK

• Please allow 6 - 8 weeks for printed items from approved art.



**Printed Tissue:** Pick a PMS print color and we will match it.

– See page 113 for Special Order Tissue Colors!

CODE	DESCRIPTION	SIZE (in)	PACKAGED	PRICE/EACH	
				10 REAMS	30 REAMS
20869000G	White	20 X 30	480	\$64.00	\$60.00
20869000M	Colored	20 x 30	480	\$89.00	\$81.00
20869000GK	Kraft	20 x 30	480	\$64.00	\$60.00
20869001M	Metallic SS*	20 x 30	200	\$183.30	\$114.55

\* SS - single sided

Print included in price of tissue.

Minimum 10 reams. Note: Plates extra \$275.00 (per color).  
Ships in approximately 6 - 8 weeks.

For metallic ink print: add 10% to the price above.  
For > 50% ink coverage, an additional \$10 per ream.  
All custom orders subject to a +/-10% over/under run.

Custom Printed  
White Tissue  
- 10 Reams  
**\$640.00**

# IN STOCK

Available for immediate shipment.

**Spotlight Value Item**  
12 in stock tissue colors to choose from.  
Plus check out our assorted Pre-Packs!



## Christmas Assortment Pre-Pack

20855101G - 20 x 30" - **\$36.95/Pack**  
Contains 100 of each:  
Red, Emerald, Metallic Gold, Metallic Silver.



## Spring Assortment Pre-Pack

20855100G - 20 x 30" - **\$36.95/Pack**  
Contains 100 of each:  
Green, Lemon, Tangerine, Pink, Blue.

## Spotlight Tissue Colors

CODE	DESCRIPTION	SIZE (in)	PKG	PRICE/EACH		
				1 - 4 REAMS	5+ REAMS	25+ REAMS
20819290S	White Economy	19 x 29	480	\$14.06	\$12.88	\$11.70
208551__G	Spotlight on Value (colors)	20 x 30	480	\$24.99	\$24.99	\$24.99
208559__G	Spotlight on Value (metallic)	20 x 30	200	\$46.00	\$45.00	\$44.00
20850102	#1 White Economy	19 x 14.5	480	\$7.30	\$6.25	\$5.20
20851800	#1 White Bleached	18 x 9 dia.	1 roll	\$82.26/roll		
20852000	#1 White Bleached	20 x 9 dia.	1 roll	\$88.14/roll		

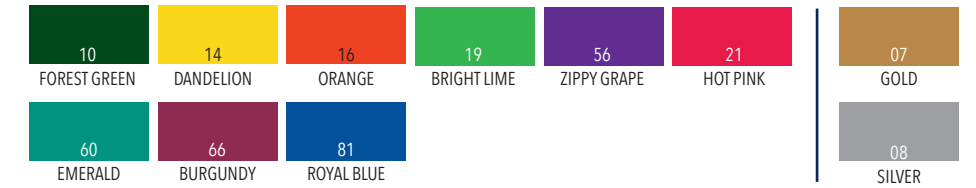

# SPECIAL ORDER

## Unprinted Tissue

Unprinted, minimum 1 ream (per color).  
Ships in approximately 4 - 6 weeks.

CODE	DESCRIPTION	SIZE (in)	Packaged	PRICE/REAM	
				1 REAM	25+ REAMS
20899__	Special Order Colors	20 x 30	480 sheets	\$35.63	\$32.06





# IN STOCK

## Inspirations Gift Wrap Seasonal

Inspirations  
Giftwrap

By Gunther Mele  
Available for immediate shipment.

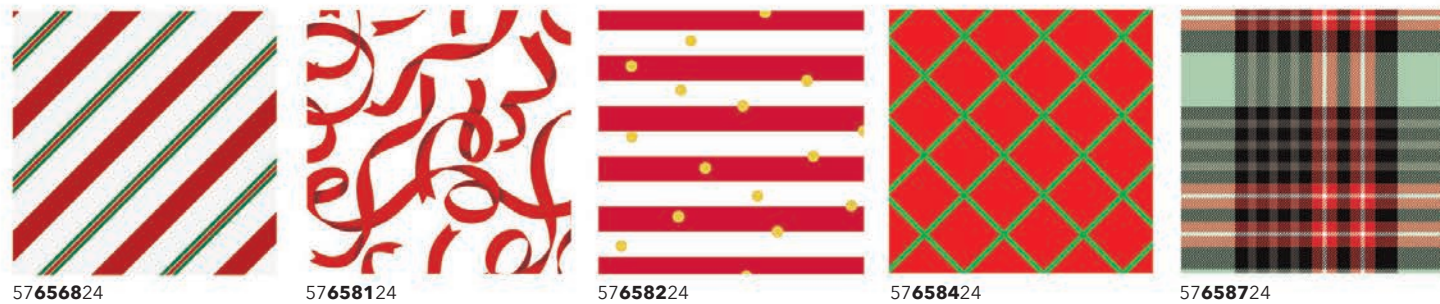

57656824 57658124 57658224 57658424 57658724



57658324 57658524 57606224 57606124 56606107

24" x 417' - 1/2 Ream Roll  
**\$79.00** Code # 57 \_\_\_\_ 24  
each

8" x 150' - Jewelers Rolls **JR**  
**\$32.50** Code # 56 \_\_\_\_ 07  
each



57657724 57657624 57654624 57655424 57605437 57657024



57655324 57653524 57656424 57657124 57658025 57658026



57658024 57605435

24" x 417' 1/2 ream roll  
**\$49.99** each  
Code # 57 \_\_\_\_\_

**SPECIAL PRICING!**  
**\$39.99** each  
**WHEN YOU BUY 3!**

Inspirations  
Giftwrap

By Gunther Mele  
Available for immediate shipment.

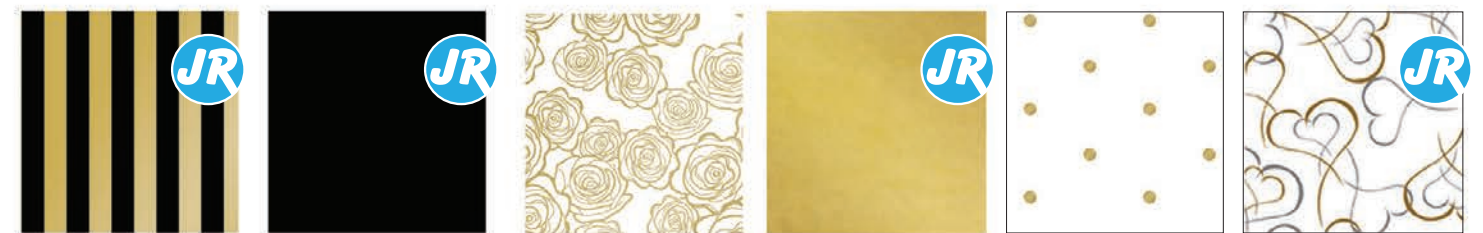

57605724 57605707 57605624 57605607 57605824 57300724 56300707 57605924 57300124 56300107

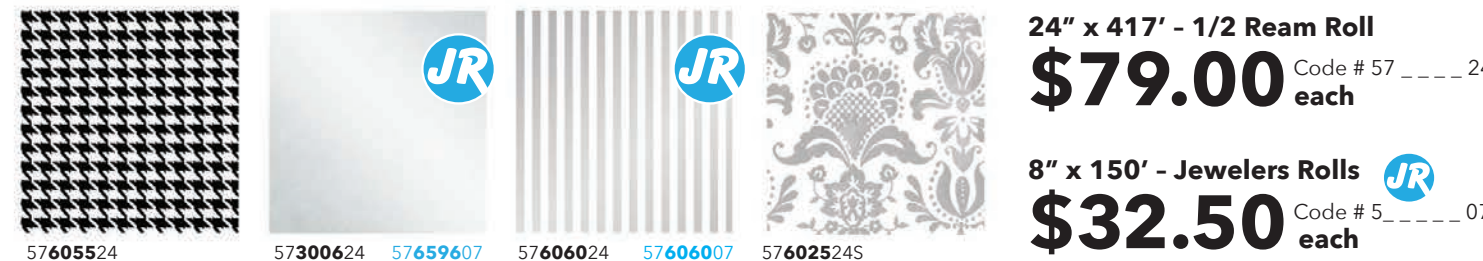

57605524 57300624 57659607 57606024 57606007 57602524S

24" x 417' - 1/2 Ream Roll  
**\$79.00** Code # 57 \_\_\_\_ 24  
each

8" x 150' - Jewelers Rolls **JR**  
**\$32.50** Code # 5 \_\_\_\_ 07  
each



57604924 57605426 57605429 57605432 57605428 57605431

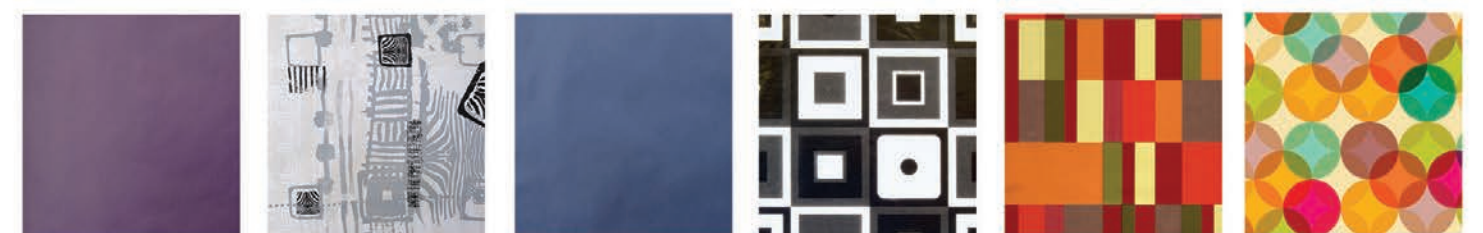

57605424 57605434 57605427 57605224 57603224 57604424



57602924 57601724 57605436 57605324 57604624 57605024



57602524 57604824

24" x 417' 1/2 ream roll  
**\$49.99** each  
Code # 57 \_\_\_\_\_

**SPECIAL PRICING!**  
**\$39.99** each  
**WHEN YOU BUY 3!**



# SPECIAL ORDER

## Sullivan Designs Seasonal

Please allow 4 - 6 weeks for shipment.

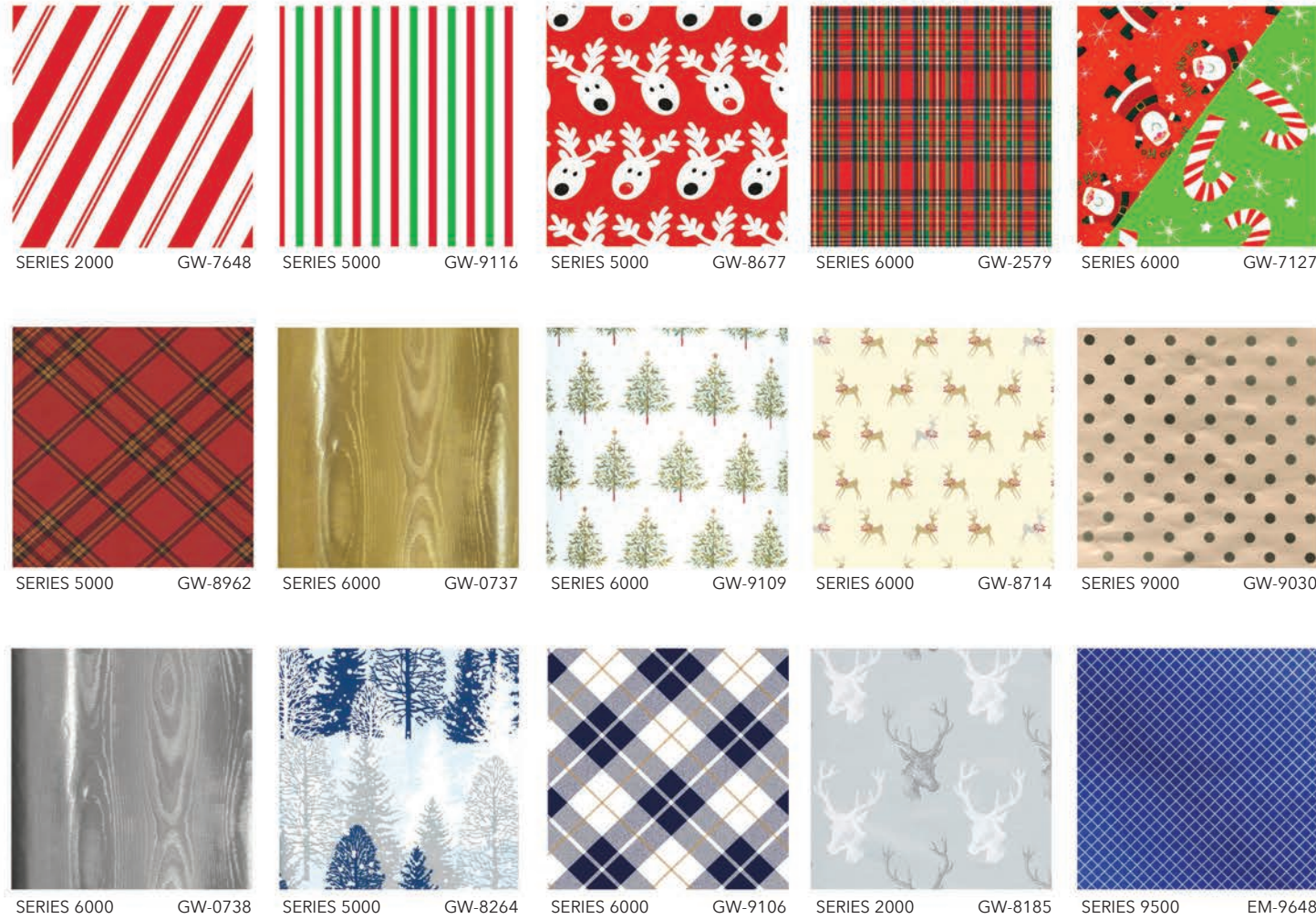

# SPECIAL ORDER

## Sullivan Designs Every Day

Please allow 4 - 6 weeks for shipment.

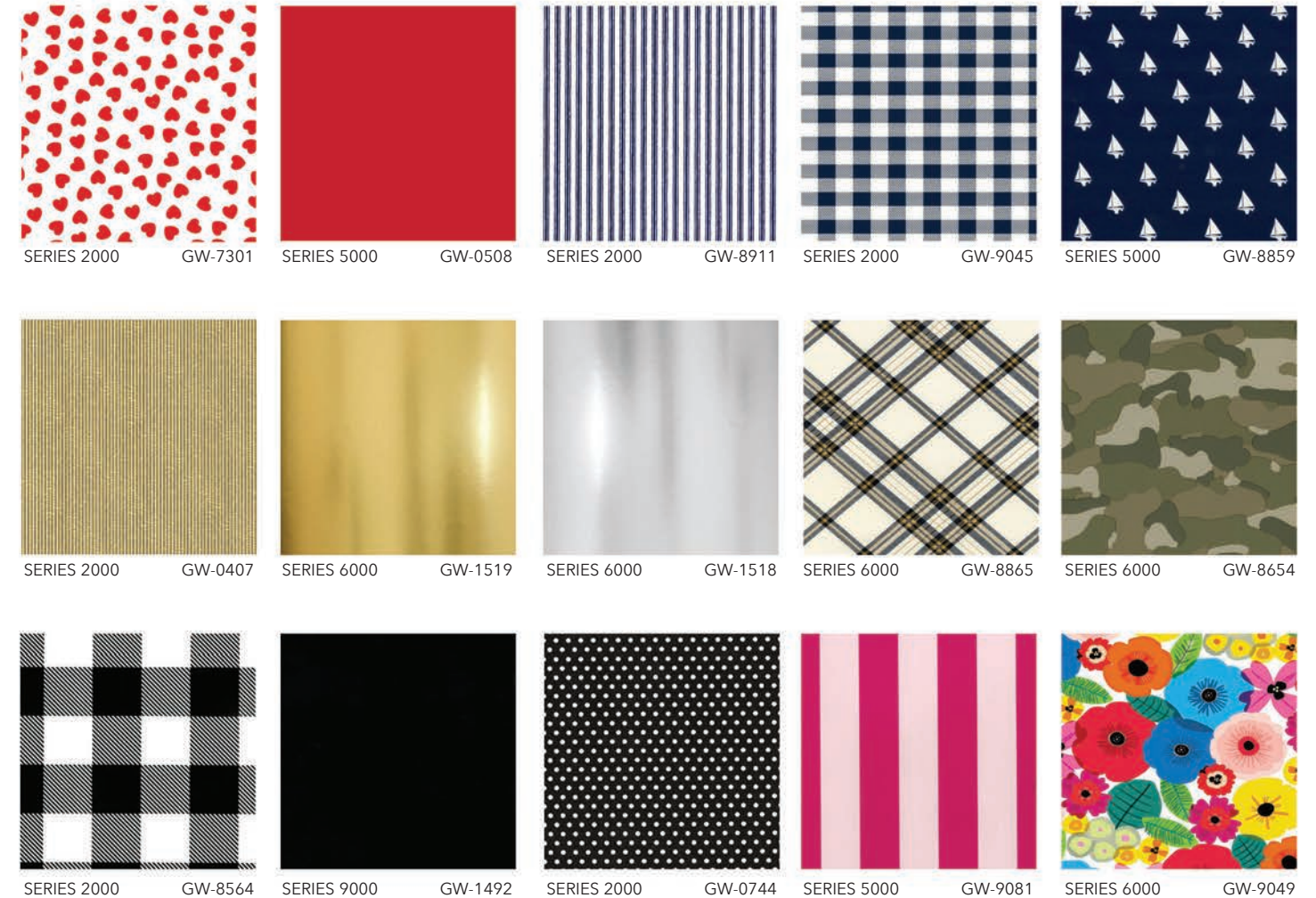

Additional custom order designs available to choose from. Contact your area sales representative for more info.

## SULLIVAN designs available in 1/2 Ream Rolls and Full Ream Rolls

NOTE: All Sullivan gift wrap orders must include GW design code.

MINIMUM ORDER: 1 Roll per design (15" rolls must be ordered in multiples of 2 rolls per design)

SLITTING CHARGE: A slitting charge of \$25.00 applies to each individual roll. No more than two slits per roll; (2 slits = \$25.00)

	15H	18H	24H	30H	15F	18F	24F	30F
Pricing Level	Half Ream 15" x 417'	Half Ream 18" x 417'	Half Ream 24" x 417'	Half Ream 30" x 417'	Full Ream 15" x 833'	Full Ream 18" x 417'	Full Ream 24" x 833'	Full Ream 30" x 833'
2000 Series	\$105.14	\$157.13	\$157.13	\$181.40	\$175.62	\$281.92	\$281.92	\$331.60
5000 Series	\$120.16	\$181.40	\$181.40	\$207.97	\$204.51	\$329.29	\$329.29	\$387.06
6000 Series	\$142.11	\$217.22	\$217.22	\$249.57	\$243.79	\$399.77	\$399.77	\$467.94
9000 Series	\$161.76	\$256.50	\$256.50	\$293.47	\$291.16	\$478.34	\$478.34	\$558.06
9500 Series	\$196.42	\$284.23	\$284.23	\$329.29	\$325.82	\$536.11	\$536.11	\$622.76

View our entire  
Selection online at  
[GUNTHERMELE.COM](http://GUNTHERMELE.COM)



Gift wrap dispenser with serrated edge can be added to your custom jewelers roll order for \$7.00 each. Code: 09715000



## Jewelers Rolls

Size: 7.375" x 150'

**\$59.00/roll**

Minimum order 1 roll.  
JRXL150 - Jeweler Roll suffix code.

## Counter Rolls

Size: 24" x 100'

**\$69.00/roll**

Minimum order 1 roll.  
-24X100 - Counter Roll suffix code.



# SPECIAL ORDER

Shamrock Designs

Please allow 4 - 6 weeks for shipment.

## Seasonal

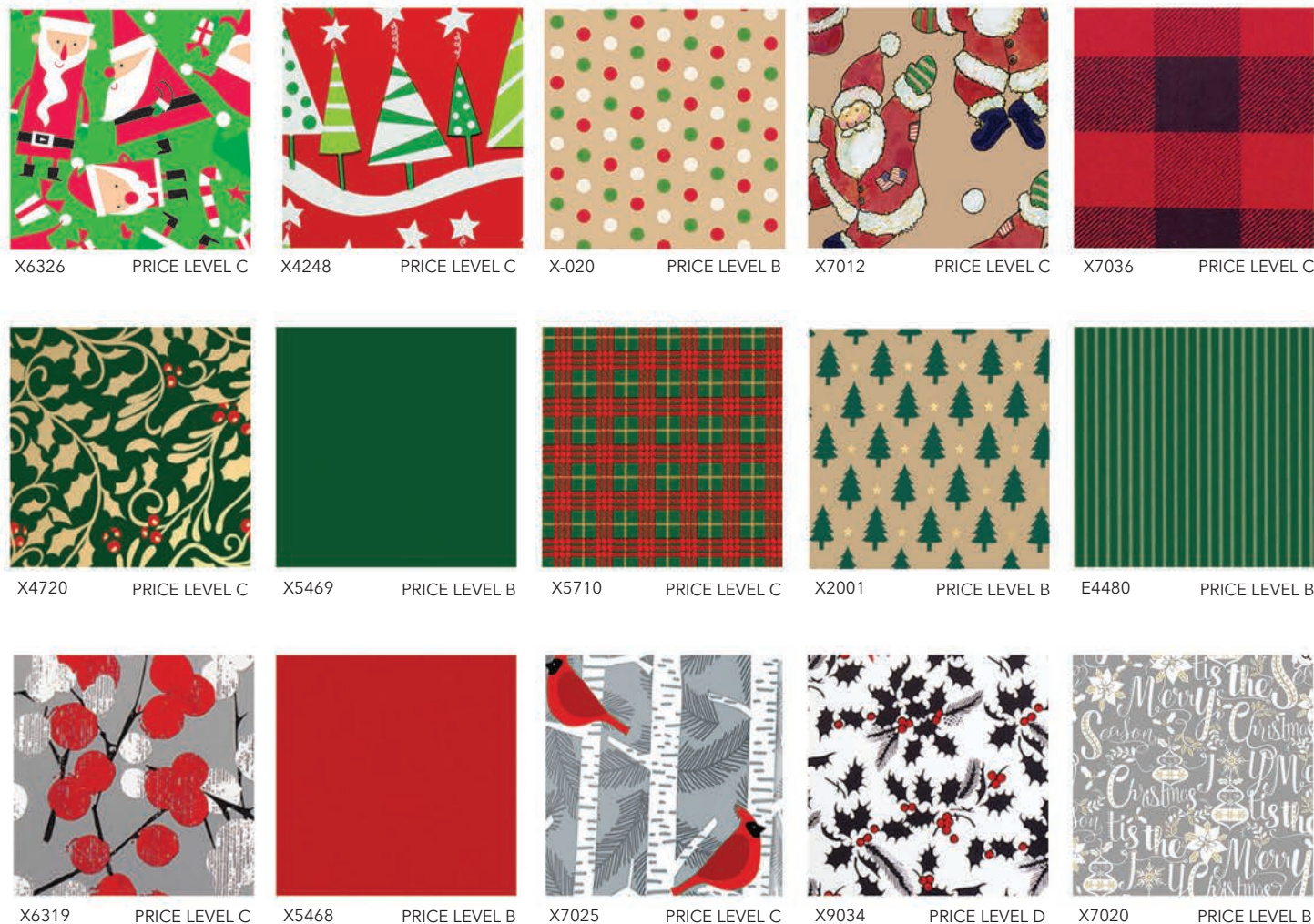

# SPECIAL ORDER

Shamrock Designs

Please allow 4 - 6 weeks for shipment.

## Every Day

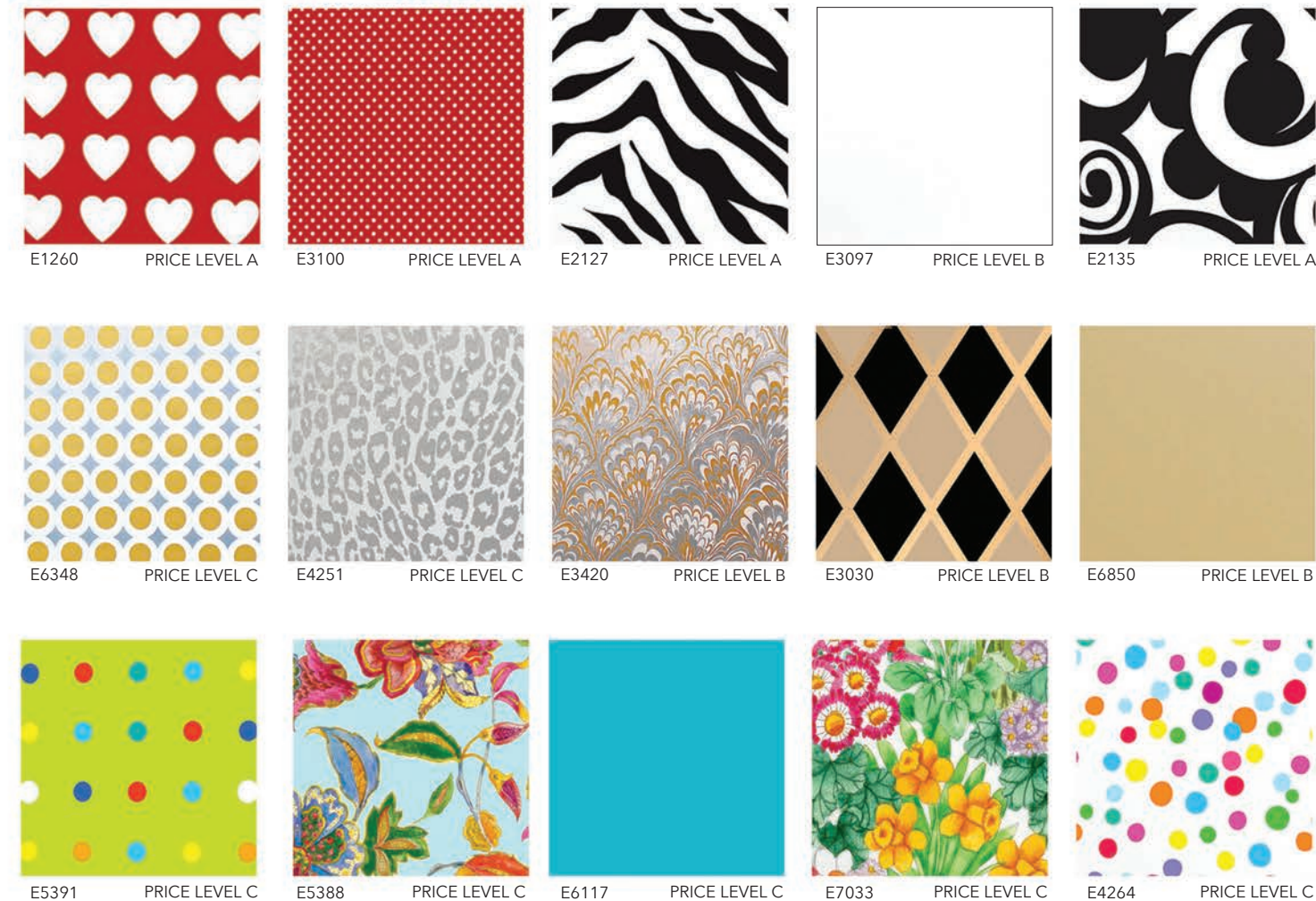

Additional custom order designs available to choose from. Contact your area sales representative for more info.

## Shamrock designs available in Cutter Boxes, 1/2 Ream Rolls and Full Ream Rolls

View our entire Selection online at [GUNTHERMELE.COM](http://GUNTHERMELE.COM)

NOTE: All Shamrock gift wrap orders must include design code.

MINIMUM ORDER: 1 Roll

**Jewelers Rolls also available. Most are minimum 3 rolls per design.\***

SLITTING CHARGE: A slitting charge of \$25.00 applies to each individual roll. (no more than two slits per roll - 2 slits = \$25.00)

Contact your sales representative for details.\* Select designs available in 1 roll minimums.

Pricing Level	7J	24C	18H	24H	30H	36H	18F	24F	30F	36F
	Jewelers Roll 7.375"x100'	Cutter Box 24" x 100'	Half Ream 18" x 417'	Half Ream 24" x 417'	Half Ream 30" x 417'	Half Ream 36" x 417'	Full Ream 18" x 833'	Full Ream 24" x 833'	Full Ream 30" x 833'	Full Ream 36" x 833'
A	\$18.63	\$37.15	\$117.99	\$107.07	\$176.99	\$176.99	\$192.28	\$181.36	\$299.35	\$299.35
B	\$23.00	\$45.89	\$146.40	\$135.47	\$222.87	\$222.87	\$251.28	\$240.35	\$397.67	\$397.67
C	\$27.37	\$54.63	\$168.25	\$157.32	\$260.02	-	\$292.79	\$281.87	\$465.41	-
D	\$29.56	\$59.00	\$181.36	\$170.43	-	-	\$321.20	\$310.27	-	-
E	\$50.26	\$100.51	\$275.31	\$264.39	-	-	\$506.92	\$496.00	-	-



# IN STOCK

Available for immediate shipment.

## Curling Ribbon

See chart for available colors

CODE	PRICE/ROLL
<b>COLORS - 3/16" x 500 yards</b> 148373 __	\$2.99
<b>METALLIC - 3/16" x 250 yards</b> 148378 __	\$8.99



## 2.75" Star Bows

See chart for available colors

CODE	CASE PACK	PRICE/EACH	
		100+	1000+
<b>COLORS - 2.75" x 17 loop</b> 142311 __	200	\$0.09	\$0.08
<b>METALLIC - 2.5" x 17 loop</b> 14531107 Gold	200	\$0.10	\$0.09
14531108 Silver	200	\$0.10	\$0.09



## 3.75" Star Bows

See chart for available colors

CODE	CASE PACK	PRICE/EACH	
		100+	1000+
<b>COLORS - 3.75" x 13 loop</b> 143512 __	200	\$0.11	\$0.10
<b>METALLIC - 3.75" x 17 loop</b> 14551207 Gold	200	\$0.18	\$0.15
14551208 Silver	200	\$0.18	\$0.15

Min: case pack

## Splendor Ribbon

See chart for available colors

CODE	PRICE/ROLL
<b>COLORS - 3/4" x 250 yards</b> 141050 __	\$9.24
<b>METALLIC - 3/4" x 100 yards</b> 14013007 Gold	\$12.60
14013008 Silver	\$12.60

Color # Name	Curling Ribbon	2.75" Star Bows	3.75" Star Bows	Splendor Ribbon
00 - White				
86 - Ivory				
29 - Vanilla				
61 - Pastel Yellow				
03 - Yellow				
13 - Daffodil				
14 - Sunshine Yellow				
07 - Gold				
08 - Silver				
27 - Holiday Gold				
22 - Melon				
73 - Coral				
16 - Tropical Orange				
17 - Orange				
12 - Chocolate				
75 - Baby Pink				
01 - Pink				
80 - Primrose				
57 - Azalea				
09 - Red				
58 - Lava Red				
66 - Burgundy				
41 - Beauty				
59 - Dubonnet Rose				
28 - Orchid				
05 - Lavender				
56 - Purple				
54 - Periwinkle				
50 - Plum				
11 - Royal				
81 - Navy				
77 - Baby Blue				
02 - Light Blue				
47 - Aqua				
32 - Caribbean Blue				
55 - Robin's Egg				
25 - Turquoise				
71 - Sea Green				
18 - Celery				
74 - Spruce				
60 - Hunter				
84 - Teal				
04 - Mint				
19 - Citrus				
96 - Leaf				
30 - Celadon				
10 - Emerald				
93 - Charcoal				
70 - Antique Silver				
15 - Black				
07 - Metallic Gold				
08 - Metallic Silver				
09 - Metallic Red				
10 - Metallic Green				
99 - Everyday Assortment	N/A			N/A
98 - Christmas Assortment	N/A			N/A



99 - Everyday Assortment Star Bows Available in 2.75" and 3.75"



98 - Christmas Assortment Star Bows Available in 2.75" and 3.75"



Metallic Star Bows Available in 2.75" and 3.75"

# IN STOCK

Available for immediate shipment.

## Perfect Bows™

Minimum: 50 per size, per color.

CODE	SIZE	PRICE/EACH	
		50+	1000+
140515 __	5.5" Perfect Bow	\$0.53	\$0.49



## Pull Bows

Minimum: 100 per size, per color.

CODE	SIZE	STANDARD COLORS		METALLIC COLORS	
		100+	1000+	100+	1000+
132000 __	Petite 2" Bows	\$0.20	\$0.17	\$0.31	\$0.29
134000 __	Std. 4" Bows	\$0.32	\$0.30	\$0.53	\$0.50



## Mini Metallic Star Bows

252 per tub

CODE	DESCRIPTION	PRICE/TUB
14121099	Assorted	\$32.30
14121017	Gold	\$32.30
14121008	Silver	\$32.30



## Matte Wraphia™

CODE	SIZE	PRICE/ROLL
148367 __	100 yds	\$8.40

## Paper Roll/Ream Dispenser and Tape

CODE	DESCRIPTION	PRICE
09850124	Paper Roll/Ream Roll dispenser - 24" rack	\$67.00 each
09725000	Transparent Tape 1/2" x 66 m	\$29.00/box of 12 Min. order: 1 box



## Cellophane (1.0mil)

CODE	DESCRIPTION	SIZE	PRICE/ROLL
16400506	Clear Cellophane	40" x 100'	\$10.50
16300506	Clear Cellophane	40" x 300'	\$23.90

## Ribbon Shredder

CODE: 09878600  
PRICE: \$6.99 each



## Curling Ribbon Roll Dispenser

CODE: 09850100  
PRICE: \$134.00 each



Holds 12 Rolls



# SPECIAL ORDER

# SPECIAL ORDER

RIBBON

RIBBON

## Printed Satin Ribbon

See chart to the right for ribbon colors.

### Single Face Satin

WIDTH	CODE	PRICE/EA
3/8" x 100 yd roll	14150002	\$47.00
5/8" x 100 yd roll	14150003	\$49.00
7/8" x 100 yd roll	14150005	\$60.00
1-1/2" x 50 yd roll	14150015	\$72.00

500 yard minimum per width.



Contact your sales representative.



Single Face Satin Ribbon with Foil Print

### Foil Print Colors

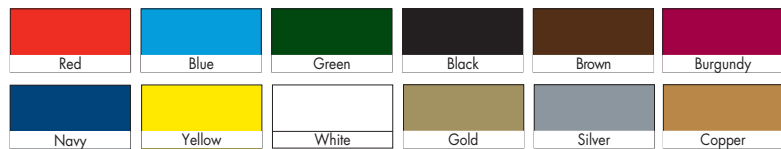

**FOIL PRINT**  
Included in price of ribbon

Please allow 3 -4 weeks for printed items from approved art.

## Unprinted Satin and Grosgrain Ribbon

See chart to the right for ribbon colors.

Lead time please allow 4 -6 weeks for shipment. SPECIAL ORDER

### Single Face Satin

WIDTH	CODE	PRICE/EA
3/8" x 100 yd roll	14031 ___	\$17.50
5/8" x 100 yd roll	14032 ___	\$18.10
7/8" x 100 yd roll	14033 ___	\$32.60
1-1/2" x 50 yd roll	14034 ___	\$18.10

1 roll minimum.

### Grosgrain

WIDTH	CODE	PRICE/EA
3/8" x 100 yd roll	14160 ___	\$17.50
5/8" x 100 yd roll	14161 ___	\$18.10
7/8" x 100 yd roll	14162 ___	\$33.60
1-1/2" x 50 yd roll	14170 ___	\$18.10

While we strive for accuracy in our catalog, actual product may be slightly different than pictured.

Please allow 3 -4 weeks for printed items from approved art.

3/8"	5/8"	7/8"	1-1/2"	COLOR NUMBER AND NAME
Single Face Satin	Grosgrain	Single Face Satin	Grosgrain	
				029 - White
				007 - Shell Grey
				012 - Silver
				015 - Grey
				022 - Pewter
				028 - Antique White
				813 - Oyster
				016 - Portobello
				030 - Black
				115 - Powder Pink
				117 - Light Pink
				150 - Pink
				156 - Hot Pink
				175 - Shocking Pink
				187 - Azalea
				241 - Living Coral
				250 - Red
				252 - Hot Red
				260 - Scarlet
				275 - Wine
				277 - Burgundy
				285 - Plum
				305 - Light Blue
				331 - Dusty Blue
				312 - Blue
				315 - Navajo Turquoise
				329 - Cobalt
				340 - Turquoise
				343 - Tornado Blue
				350 - Royal
				352 - Electric Blue
				353 - Century Blue
				365 - Light Navy
				370 - Navy
				412 - Purple Haze
				430 - Light Orchid
				450 - Orchid

3/8"	5/8"	7/8"	1-1/2"	COLOR NUMBER AND NAME
Single Face Satin	Grosgrain	Single Face Satin	Grosgrain	
				462 - Royal Orchid
				464 - Delphinium
				465 - Purple
				470 - Regal Purple
				473 - Amethyst
				528 - Lemon Grass
				530 - Mint
				533 - Jungle Green
				547 - New Chartreuse
				548 - Kiwi
				550 - Apple Green
				558 - Leaf
				567 - Spring Moss
				570 - Moss
				580 - Emerald
				586 - New Neon Green
				587 - Forest Green
				617 - Baby Maize
				640 - Lemon
				645 - Daffodil
				650 - Maize
				660 - Yellow Gold
				675 - Gold
				690 - Old Gold
				722 - Burnt Sienna
				743 - Ginger
				750 - Torrid Orange
				789 - Sherry
				790 - Currant
				810 - Ivory
				815 - Cream
				825 - Natural
				835 - Tan
				841 - Khaki
				850 - Brown
				866 - Coffee

All print orders subject to set-up charges. Applicable artwork, and plate charges may apply. See page 130.



# IN STOCK

In stock and ready to ship.

## Simply Sheer Asiana Ribbon

Monofilament-Edge



CODE	SIZE	PRICE/ROLL
149435 __	7/8" x 100 yards	\$11.40
149436 __	1 1/2" x 100 yards	\$12.50

• minimum order: one roll.



# SPECIAL ORDER

Please allow 4 - 6 weeks for shipment.

## Contessa Ribbon

Wire-Edge Single Face Satin



CODE	SIZE	PRICE/ROLL
14163 ___	1 1/2" x 25 yards	\$14.00
*14164 ___	2 1/4" x 25 yards	\$21.00

• minimum order: one roll.



\* 2-1/4" is only available in 029-White, 260-Scarlet, 643-Buttercream and Ivory (810).

## Encore Ribbon

Wire-Edge



CODE	SIZE	PRICE/ROLL
141650 __	5/8" x 25 yards	\$6.10
141660 __	1 1/2" x 25 yards	\$12.20
141670 __	2 1/2" x 25 yards	\$18.25

• minimum order: one roll.



\* not available in 5/8"  
† not available in 2 1/2"

## Garbo Ribbon



CODE	SIZE	PRICE/ROLL
14168 ___	5/8" x 100 yards	\$50.00
14169 ___	1 1/2" x 50 yards	\$38.66

• minimum order: one roll.



\* not available in 5/8"  
† not available in 1 1/2"



Please allow 4 - 6 weeks for printed items from approved art.

# CREATE YOUR OWN LOOK

## Raised Ink Printing

See chart below for ribbon colors.

Pick your own colors for raised print - NO PLATE CHARGE

WIDTH	PRICE EACH	Single Face Satin CODE	Grosgrain CODE	Sheer CODE
5/8" x 100 yd roll	\$44.00	14140039	14150042	14140045
7/8" x 100 yd roll	\$47.00	14140040	14150043	14140046
1-1/2" x 50 yd roll	\$83.00	14140041	14150044	14140047

40 roll minimum for all printed ribbon.

## Sheer Ribbon Colors

All colors are available in all sizes. See page 123 for single face satin and grosgrain color availability.



Single Face Satin Ribbon with Raised Print



Sheer Ribbon with Raised Print



Grosgrain Ribbon with Raised Print





## Customized Seals-Foil Printed

CODE	SIZE	One color foil print/each		SPECIAL ORDER Two color/each		SPECIAL ORDER Acetate 1 color/each		SPECIAL ORDER Acetate 2 color/each	
		2000+	5000+	2000+	5000+	2000+	5000+	2000+	5000+
25	A	\$0.088	\$0.082	\$0.140	\$0.110	\$0.160	\$0.125	\$0.183	\$0.142
	B	\$0.100	\$0.090	\$0.150	\$0.120	\$0.192	\$0.151	\$0.220	\$0.176
	C	\$0.120	\$0.110	\$0.165	\$0.134	\$0.229	\$0.176	\$0.258	\$0.210
	D	\$0.135	\$0.120	\$0.172	\$0.143	\$0.283	\$0.227	\$0.310	\$0.244
		<b>\$70 plates</b>		<b>\$95 plates</b>		<b>\$70 plates</b>		<b>\$95 plates</b>	

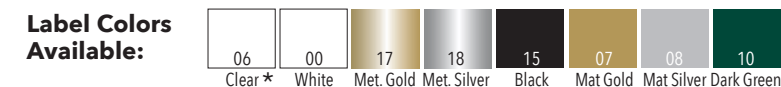

\* These items are SPECIAL ORDER. See foil chart on inside back cover of catalog for available print colors.



**FOIL PRINT**  
Included in the price. Please allow 2-3 weeks for printing.

## Pre-printed Labels



CODE	SIZE	CASE	PRICE/EACH	
			1000+	5000+
25401007S	5/8 x 3/8"	1000	\$0.088	\$0.082
25401407S	5/8 x 3/8"	1000	\$0.088	\$0.082
25406208S	5/8 x 3/8"	1000	\$0.088	\$0.082
25401007V	3/4" oval	1000	\$0.088	\$0.082
25401407V	3/4" oval	1000	\$0.088	\$0.082
25406008S	3/4" oval	1000	\$0.088	\$0.082

1000/box minimum order - 1 box of 1000.

Available for immediate shipment.

For a no-print solution, order our in stock embossed seals.

## Embossed Seals

CODE	SIZE	PRICE/EA
Gold 08701207	1.5" dia.	\$0.0400
Silver 08701208	1.5" dia.	\$0.0400

ACTUAL EMBOSSED PATTERN 1.5" DIA.

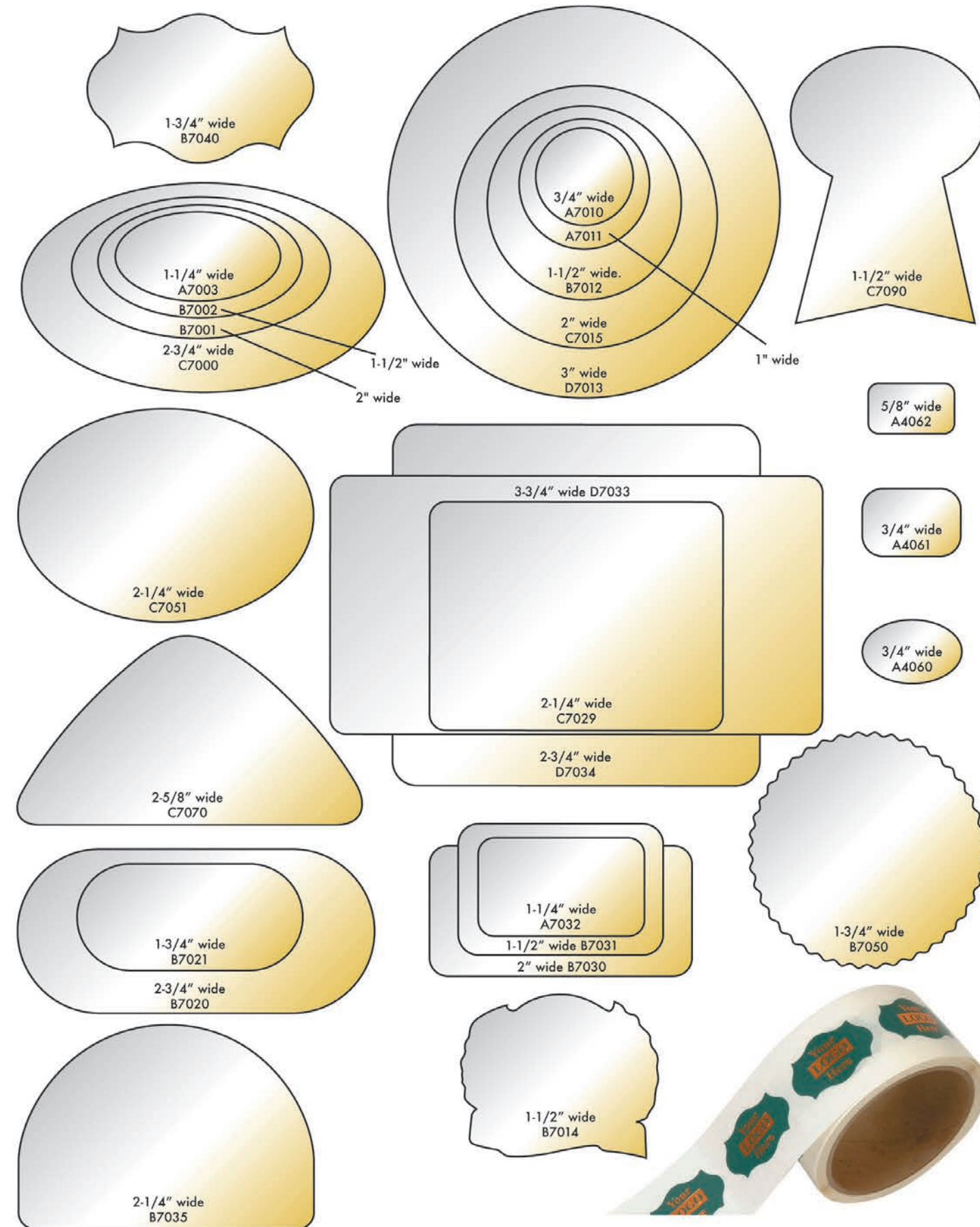

All print orders subject to set-up charges. Applicable artwork, and plate charges may apply. See page 130.

All print orders subject to set-up charges. Applicable artwork, and plate charges may apply. See page 130.



# SPECIAL ORDER

# SPECIAL ORDER

Please allow 4 - 6 weeks for printing from approved art. NO PLATE CHARGE!

Please allow 4 - 6 weeks for printing from approved art. NO PLATE CHARGE!

CUSTOM FULL COLOR SEALS

CUSTOM FULL COLOR SEALS

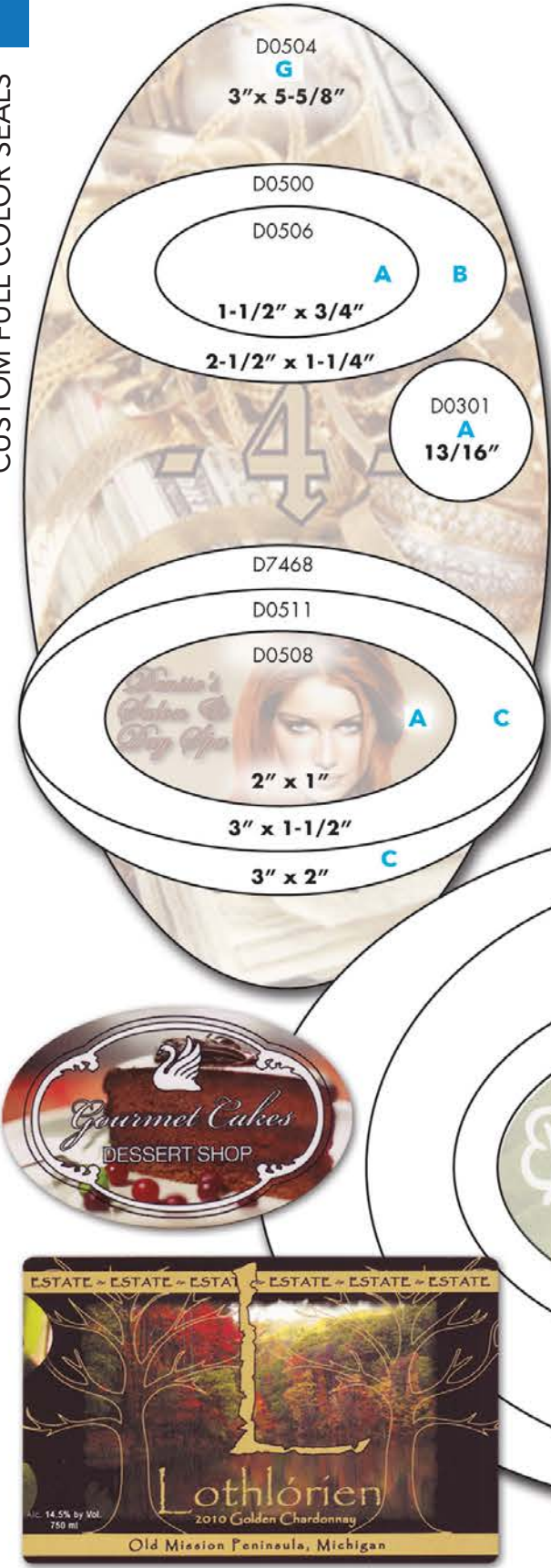

ALL PRICES ARE PER EACH

Group	1000	2000	3000	5000	10000
A	\$0.251	\$0.163	\$0.123	\$0.080	\$0.048
B	\$0.306	\$0.192	\$0.138	\$0.096	\$0.067
C	\$0.351	\$0.212	\$0.159	\$0.119	\$0.091
D	\$0.368	\$0.233	\$0.183	\$0.146	\$0.117
E	\$0.392	\$0.265	\$0.217	\$0.180	\$0.151
F	\$0.422	\$0.307	\$0.260	\$0.222	\$0.194
G	\$0.422	\$0.337	\$0.290	\$0.252	\$0.224
H	\$0.503	\$0.407	\$0.360	\$0.322	\$0.291
I	\$0.521	\$0.430	\$0.383	\$0.345	\$0.312

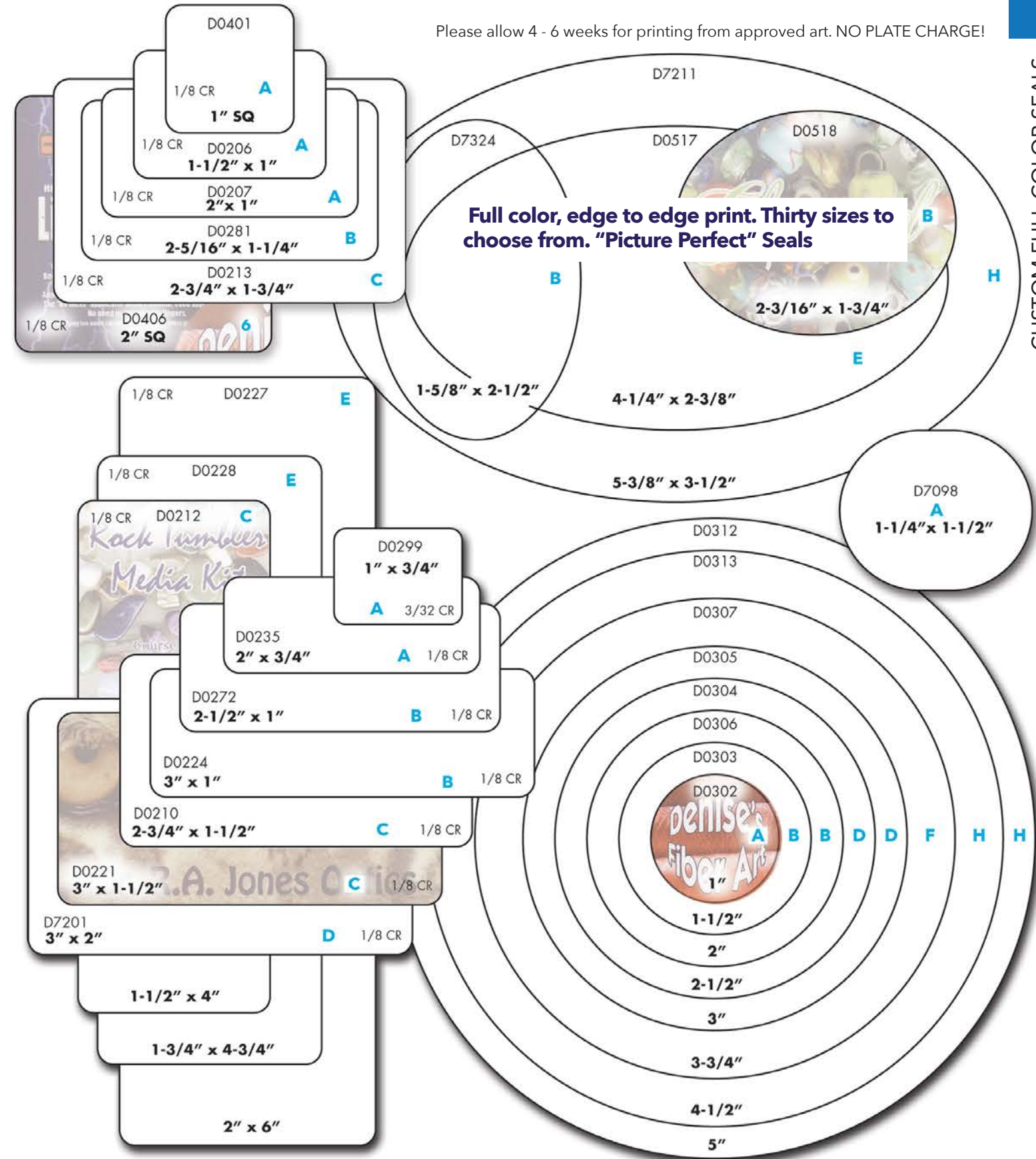



# PRINTING INFORMATION

Have your name and logo printed... it's easy!

## 1. Select your box or bag style, color and size.

## 2. Choose the printing method you wish to use.



A. **FOIL PRINTING:** Foil is applied to the bag or box using a combination of heat and pressure on a magnesium print plate to create an elegant appearance. Choice of Metallic or Matte foils. Cost of Foil Printing Print plate per size and color - \$70.00 (maximum 30 square inches)



B. **PAD PRINTING:** Ink is applied to smooth surfaces allowing us to print your logo in places never before possible. Cost of Pad Print plate per size and color - \$95.00 (maximum 3.75 square inches)



C. **INK IMPRINTING:** Ink is applied to the box or bag using a rubber printing plate. This method is ideal for larger coverage imprints and is economically priced. Cost of Ink Printing Plate per size per color starting at \$125.00. (maximum 25 square inches)



D. **SILK SCREEN:** Die fast ink is applied to Fabric Style Bags through a screen. The process allows the ink to permeate into the fabric dimples for optimal coverage. Screen charge of \$65.00 applies with each order.



E. **FULL COLOR DIGITAL PRINTING:** Utilizing the latest 4-color process technology, we now offer full color digital printed graphics on fabric and nylon bags using a heat press process. This full color digital printing creates a transfer that allows for vibrant images on both lights and darks. Pricing is the same regardless of the amount of colors used in a design. Have your full color image applied to your bags for just \$1.25 per bag (minimum 300 bags)

## 3. Choose the Imprint Color

When Foil Printing, select from 41 foil colors in 4 different finishes: Metallic (High Sheen or Matte), Flat, Gloss or Pearlized. For ink printing select from our 9 Standard colors for in stock items, or ask about Pantone Matching for Special Order items such as Simply Bags and Fabric Style Bags.

## 4. Send us your artwork.

If you are a new print customer, send us your artwork by e-mail. Artwork must be vector with fonts outlined or high resolution (300 dpi) jpg if vector can not be located.

If you don't have artwork or your artwork needs adjustments, we have a talented design team who can assist you. Contact one of our sales representatives or email us your ideas today. For pricing, see the artwork charges section.

### Acceptable Artwork Formats

- Vector files (preferred): Adobe Illustrator with .ai, .eps, or .pdf file extension. If the logo was ever professionally made, at a marketing agency, print shop or sign maker, they will have the logo on file. Check with the original graphic designer. If vector cannot be provided, ALL raster formats will be subject to additional art charges as in most cases it will have to be converted to a vector to meet our printers requirements.
- Raster files: (ie. PDF, PSD, TIF, or JPEG) Actual size, high resolution (300dpi or more), is required for all full color reproduction.
- Please include fonts (.ttf) or convert fonts to outlines when sending ANY Illustrator file, saved as AI, EPS or PDF.

### The following formats are NOT acceptable

- Publisher (.pub) • CorelDraw (.cdr) • small GIF or BMP internet images • low resolution JPG
- Any Word or spreadsheet documents - '.docx', '.xls', '.wpd', '.od'

If unsure about any format including "what is a vector" please send all inquiries to your inside Customer Service Rep

## OTHER PRINTING COSTS

**Artwork Charges:** As mentioned above, we have a talented creative team that can work with you to design, create, manipulate or re-size your store logo or name. Artwork service is charged at a rate of \$75.00/hour, min. 1/2 hour.

**Set-up Charges:** Every print job requires a machine to be set-up. A charge will be applied to every order. Foil, Ink, Pad and Digital printing is charged at \$34.00. Silk Screen printing is \$65. Please note: multiple print sizes of the same logo require multiple set-ups.

**Plate Charges:** Plate charges apply one-time only. Each time you require a 'new' print design (i.e. Logo change, Print Size Adjustment etc.) a new plate must be created. Once the plate is made, we will hold it for you in our warehouse and it will be available for all future printing requirements. Plate charges range in cost from \$70.00 for a Foil Printing plate to \$125+ for an Ink Printing Plate. (maximum 25 square inches)

## FOIL STAMPING COLORS

### Metallic Options

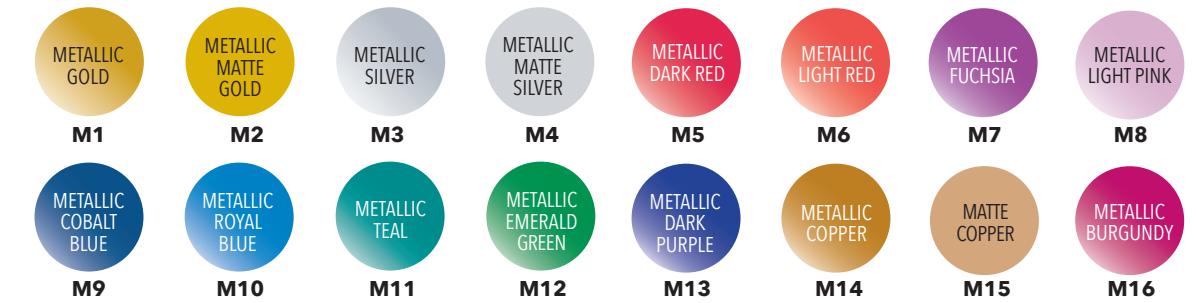

Metallic options feature a high sheen finish unless otherwise indicated as matte finish.

### Flat Options



### Pearlized Options

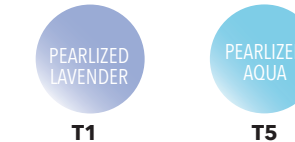

### Gloss Options

Gloss Clear - allows the color of the bag or box to show-through. Gives that tone on tone special highlighted look.

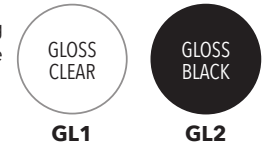

### Satine Foil Colors



## INK IMPRINTING COLORS



## PAD IMPRINTING COLORS

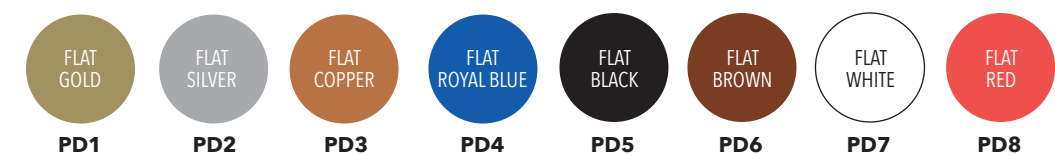

Colors shown are representations only and may not reflect true production colors.





**GUNTHERMELE** 1857

PACKAGE WITH PURPOSE

**TO PLACE AN ORDER**

Call Customer Service: 716.821.1472  
Toll Free: 1.800.516.0108  
Order on line: gunthermele.com  
Direct Fax: 716.821.1480



**EASY PAYMENT OPTIONS**

- Online at: gunthermele.com and pay with your credit card
- Over the phone, by: Visa or Mastercard
- Contact head office to set up ACH

Sign up for paperless billing. See our website for more information.

**PROUD MEMBER  
SEE US AT THESE SHOWS IN 2020 !**



**January 25 - 27, 2020**  
RJO Winter Buying Show  
**July 18 - 20, 2020**  
RJO Summer Buying Show



**February 22 - 24, 2020**  
SJO Winter Buying Show



**February 29 - March 3, 2020**  
IJO Winter Buying Show  
**July 24 - 28, 2020**  
IJO Summer Buying Show



**March 7 - 9, 2020** Atlanta  
SJTA Spring Jewelry Show  
**August 8 - 10, 2020** Atlanta  
SJTA Summer Jewelry Show



**June 2 - June 5, 2020**



**June 9 - 11, 2020**



**June 23 - 25, 2020**  
Pawn Expo 2020



**PROUD MEMBER**

**TERMS AND CONDITIONS:**

- Minimum order \$250.00.
- F.O.B point: Buffalo, NY USA
- Net 30 days O.A.C.
- New account payment terms: Visa or MasterCard 50% deposit with order, balance due upon shipping.
- Defective merchandise will be accepted back for credit only if claimed within 15 days of receipt of shipment. Authorization number must be obtained by contacting our customer service department 1.800.516.0108.

- In-transit damages and shortages must be claimed with the freight carrier at time of delivery.
- All lead times are estimates only (from receipt of approved artwork and credit) and are not guaranteed.
- Plate charges where applicable are:  
Foil Print Dies: \$70.00 per size (maximum 30 square inches)  
Pad Dies: \$95.00 per size (maximum 3.75 square inches)  
Ink Plates \$125.00 (maximum 25 square inches)
- **While we strive for accuracy in our catalogue, actual product may be slightly different than pictured.**
- Prices subject to change without notice.